

Title: Sweeper (Brushes With Convoluted Sections) (Two Piece End Caps) (72")

Model Number: Sweeper

Serial Number: Loader

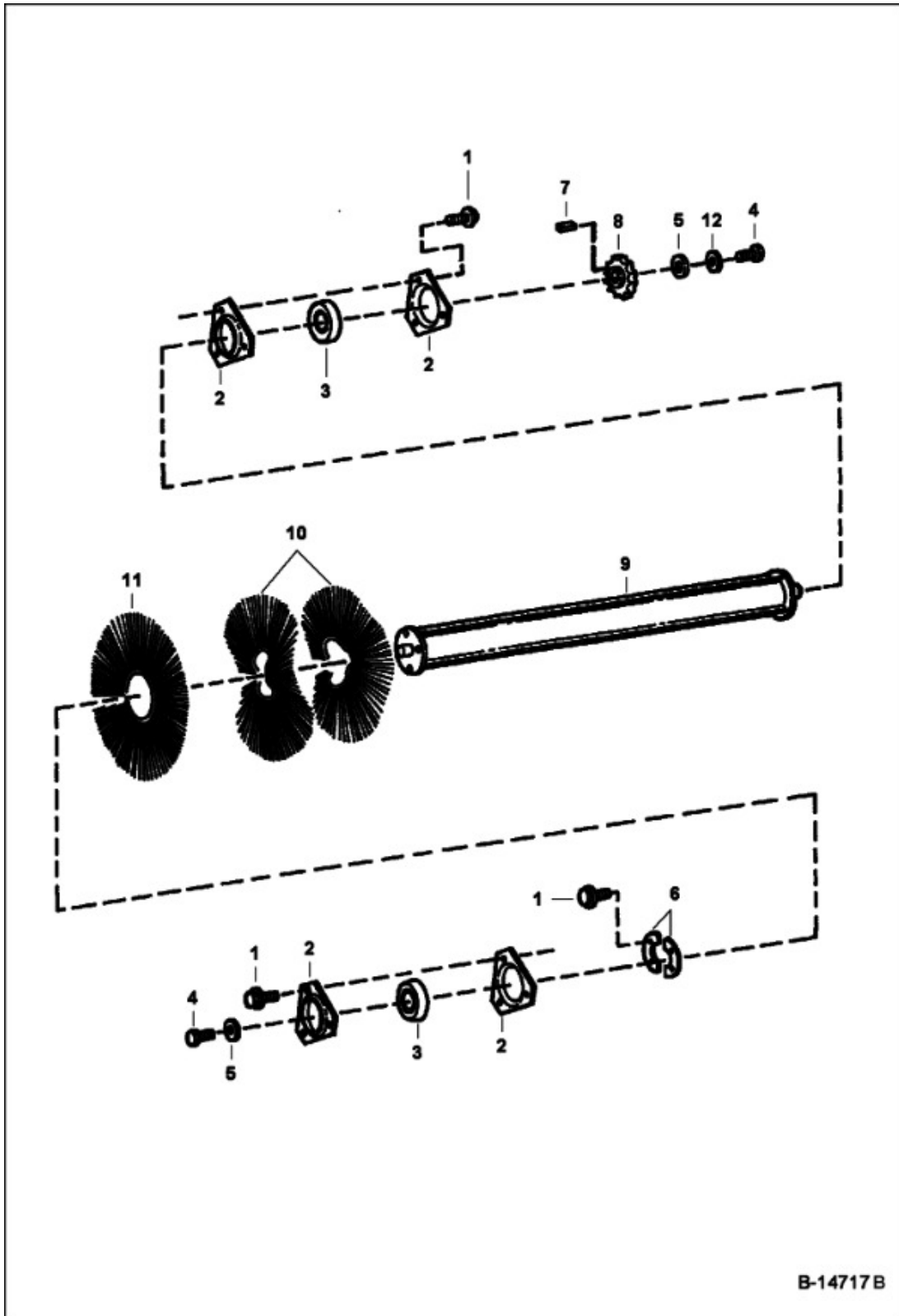

Title: Sweeper (Brushes With Convoluted Sections) (Two Piece End Caps) (72")

Model Number: Sweeper

Serial Number: Loader

Ref.	Part Number	Description	S/N	Qty
1	84G3712	SCREW THD ROLLING TT		10
2	6599441	FLANGE, BRUSH SWEEPER 5		4
3	6538846	BEARING, SWEEPER, Use without locking collar		2
4	17C820	BOLT 5, for shafts with 38.1mm (1.50") deep threads		2
4	17C824	BOLT 5, for shafts with 44.5mm (1.75") deep threads		2
5	6704978	WASHER		2
6	6708813	COVER		2
7	7J4102	KEY		1
8	6813247	SPROCKET, Drive - 17 Teeth - Was 6708812, A		1
9	6708806	TUBE, DRIVE ASSY		1
10	6652802	BRISTLE POLY CONVOLUTED 21 3/8 IN, factory option - polypropylene		36
10	6652802EF	BRISTLE, EF BLACK CONV 21 3/8, Was 6988131, A		36
10	7241794	BRISTLE POLY HD CONVOLUTED 21 3/8 IN, polypropylene		36
10	6989142	BRISTLE POLY/WIRE CONVOLUTED 21 3/8 IN, polypropylene		36
10	7299056EF	BRISTLE,POLY/WIRE 21 3/ 8 EF BLACK CONV, polypropylene		36
10		BRUSH, STEEL CONVOLUTED 21 3/8", BRUSH, STEEL CONVOLUTED 21 3/8", NLA - factory option - Order 6989019 bristle - Was 6648798, A		39
10	6989019	BRISTLE WIRE CONVOLUTED 21 3/8 IN		39
11	6648797	BRISTLE POLY STRAIGHT 21 3/8 IN, factory option - polypropylene - to fill space if needed		x
11	6988130	WAFER, 21 3/8' EARTHFORCE FLAT, to fill space if needed		x
11		BRISTLE, POLY HD 21 3/8" FLAT, BRISTLE, POLY HD 21 3/8" FLAT, NLA - Order 6648797 - to fill space if needed - SEE NOTE - Was 6989018, A		x
12	6693407	WASHER, lock		1