

ONE SAFE SOURCE

2002 - 2003



CAT®

IF YOU NEED A HOSE, WE'RE YOUR ONE SAFE SOURCE

HERE'S WHY:

We provide one-stop hose service for Cat and other makes of equipment. Whether you call ahead or take advantage of our "while you wait" service, you can count on replacement hoses that are . . .



Built **Right!**

Our skilled technicians are committed to delivering quality assemblies featuring highly accurate crimps and the industry's best hose products.

Built **Clean!**

During assembly, we use special tooling to remove harmful contaminants other assemblers leave inside the hose!



Built **Fast!**

We understand the effect of downtime on your bottom line, so the last element of our service is getting you out the door in a hurry.

For a complete listing of Cat hose products . . . consult the Cat Hose Products & Tooling catalog, PECP5030.

Air Intake and Exhaust Systems	3
Batteries and Electrical Parts	19
Chemicals, Compounds, and Paint	45
Cooling Systems	63
Filters	69
Ground Engaging Tools — Backhoe Loaders	211
Ground Engaging Tools — Bulldozers/Compactors	221
Ground Engaging Tools — Excavators	253
Ground Engaging Tools — Loaders	277
Ground Engaging Tools — Motor Graders	309
Ground Engaging Tools — Paving Products	323
Ground Engaging Tools — Rippers/Scarifiers	325
Ground Engaging Tools — Scrapers	331
Hardware	337
Lubricants	403
Operator Conveniences	425
Remanufactured Products	437
Seals	447
V-Belts	487
Index	495

Introduction

As your Cat dealer, we're your One Safe Source for all of your equipment needs — from machines and engines to parts and services.

We're proud to offer the industry's best support, including the thousands of Caterpillar parts listed in this new edition of the One Safe Source catalog. You can count on genuine Cat parts to deliver top performance and long life because they're built to high-quality, original equipment standards.

You can count on us for fast delivery and quality service. We carry most parts listed in this catalog in stock for immediate, off-the-shelf convenience, and our comprehensive service options get your machines up and running quickly.

We're here to help you get the most from your Cat equipment. That means offering only genuine Cat parts, available only from us — your One Safe Source.

Part numbers and specifications are subject to change without notice. To ensure you receive the correct parts, please provide the model and serial number of the machine on which they'll be used.

Some of the products listed in this catalog are not available in certain parts of the world. Please check with us for more information.

AIR INTAKE AND EXHAUST SYSTEMS

Mufflers	4
Pre-Cleaners	7
Turbine Pre-Cleaners	8
Exhaust Pipe Extensions	14
Air Intake Pipe Extensions	16
Air Intake and Exhaust Stack Clamps	17
Rain Traps and Rain Caps	18

Air Intake and Exhaust Systems

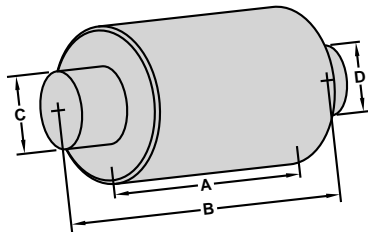

Mufflers

- Help reduce engine exhaust sound and aid in operator comfort.
- Are essential for machines working in enclosed areas.

A BODY LENGTH (in) (mm)		B OVERALL LENGTH (in) (mm)		C INLET DIAMETER (in) (mm)		D OUTLET DIAMETER (in) (mm)		PART NUMBER	ADDITIONAL PARTS
9.20	233.7	16.70	424.2	2.50	63.5	2.50	63.5	3B-6217	
11.00	279.4	18.00	457.2	3.00	76.2	3.13	79.4	8S-4996*	
11.00	279.4	19.00	482.6	4.00	101.6	4.00	101.6	3B-6216	
11.00	279.4	19.10	485.1	3.50	88.9	3.50	88.9	5H-2656	
11.90	302.3	19.10	485.1	3.00	76.2	3.00	76.2	3B-6218	
12.19	309.6	17.00	431.8	3.00	76.2	3.13	79.4	3K-3124	
12.20	309.9	17.06	433.4	4.63	117.5	5.13	130.2	6N-0731	
13.25	336.6	22.25	565.2	4.03	102.4	4.00	101.6	7E-3683	
13.26	336.8	28.46	722.8	4.03	102.4	4.00	101.6	4Y-4951	
13.46	341.8	15.34	389.6	5.00	127.0	5.13	130.2	7W-6186	
14.00	355.6	22.05	560.0	5.13	130.2	4.13	104.8	8N-9463	
14.74	374.5	23.25	590.6	5.04	128.0	5.00	127.0	1W-9229	
15.09	383.4	17.50	444.5	3.00	76.2	2.63	66.7	7N-4674	
15.50	393.7	21.00	533.4	3.00	76.2	3.13	79.5	4P-0660	
16.25	412.7	26.62	676.2	4.03	102.4	4.14	105.2	112-3249*	
16.49	418.8	18.22	462.7	3.00	76.2	3.13	79.4	4W-7762	
17.10	434.3	26.75	679.5	4.37	111.1	4.50	114.3	8S-2809	
17.10	434.3	31.25	793.8	4.37	111.1	4.50	114.2	7N-8117	
17.10	434.3	34.75	882.6	4.37	111.1	4.50	114.3	2P-5081	
17.12	434.8	23.00	584.2	4.00	101.6	5.00	127.0	1W-2572	
17.12	434.9	23.00	584.2	4.00	101.6	5.00	127.0	6N-3964	
17.38	441.5	22.32	567.0	3.00	76.2	3.13	79.4	7N-0061	
17.50	444.5	20.73	526.5	3.63	92.1	4.13	104.8	8N-5388	
17.63	447.8	22.00	558.8	5.00	127.0	5.12	130.1	8S-9473	2B-6296 (2) - stud
17.81	452.4	23.75	603.3	4.37	111.1	4.50	114.2	1P-0408	
17.81	452.4	26.75	679.5	4.37	111.1	4.50	114.3	7S-8443	
18.00	457.2	25.71	653.1	3.50	88.9	3.63	92.1	1W-4623	
18.10	459.7	26.14	663.9	5.00	127.0	5.19	131.8	7W-7439	
18.22	462.8	18.22	462.8	3.00	76.2	3.13	79.4	4P-4757	
18.22	462.8	26.62	676.2	4.00	101.6	4.13	104.8	4N-7870*	
18.50	470.0	18.50	470.0	2.89	73.4	2.89	73.3	127-8592	
18.50	470.0	18.50	470.0	2.89	73.4	2.89	73.3	127-8594	
18.81	477.8	27.31	693.7	3.87	98.4	4.13	104.8	7S-7693	
19.00	482.6	25.50	647.7	3.50	88.9	3.63	92.1	7C-7344	
19.00	482.6	25.50	647.7	4.03	102.4	4.14	105.2	9S-9328	
19.41	493.0	23.90	607.0	5.04	128.0	6.15	156.2	7N-1393	
19.44	493.7	26.89	683.0	5.00	127.0	5.00	127.0	7E-0853	

* Ejector is included with muffler.

Air Intake and Exhaust Systems

Mufflers

A BODY LENGTH (in) (mm)		B OVERALL LENGTH (in) (mm)		C INLET DIAMETER (in) (mm)		D OUTLET DIAMETER (in) (mm)		PART NUMBER	ADDITIONAL PARTS
19.65	499.1	26.00	660.4	5.04	128.0	6.19	157.2	164-9634*	
19.69	500.0	19.69	500.0	2.87	73.0	2.87	73.0	9Y-0254	
19.90	505.5	24.67	626.5	4.57	116.0	5.15	130.8	7C-5851	
20.00	508.0	29.50	749.3	4.00	101.6	4.13	104.8	1W-1766	
20.00	508.0	46.50	1181.1	5.93	150.6	4.00	101.6	8S-0905	
20.15	511.9	24.67	626.5	4.57	116.0	5.15	130.8	4W-5053	
20.16	512.0	24.67	626.5	4.57	116.0	5.15	130.8	4P-6548	
20.62	523.7	24.20	614.6	5.04	128.0	6.15	156.2	164-9633*	
21.00	533.4	26.81	681.0	5.04	128.0	6.15	156.2	7N-9674	
21.31	541.2	25.48	647.2	4.00	101.6	3.63	92.1	4P-4010	
21.74	552.2	25.38	644.7	5.00	127.0	6.13	155.6	1W-4187*	
22.00	558.8	29.75	755.7	4.50	114.3	5.13	130.2	2W-3428	2P-5608 (1) - pipe 0S-1571 (2) - bolt 4V-6698 (1) - spacer
22.00	558.8	35.26	895.6	5.00	127.0	5.15	130.8	6N-5437	
22.01	559.0	25.39	645.0	4.57	116.0	5.15	130.8	1N-2936	
22.24	565.0	35.23	894.8	8.75	222.3	10.13	257.2	4W-0532	
23.50	596.9	23.50	596.9	4.00	101.6	4.13	104.8	2W-3597	
23.50	596.9	29.75	755.6	6.63	168.3	6.73	171.0	7W-3659	
23.50	596.9	29.75	755.7	6.63	168.3	6.73	171.0	7W-3660	
23.62	600.0	29.42	747.3	5.00	127.0	6.13	155.6	7C-6398	
23.69	601.7	37.00	939.8	4.00	101.6	5.13	130.2	2P-5609	
23.69	601.7	37.00	939.8	4.03	102.4	5.15	130.8	4N-8942*	
23.69	601.6	40.75	1035.0	4.00	101.6	4.13	104.8	6N-1878	
24.00	609.6	27.40	696.0	4.37	111.1	5.25	133.4	4W-3632	
24.00	609.5	31.00	787.5	4.03	102.4	5.15	130.8	2T-3814	
24.62	625.4	28.94	735.2	6.13	155.6	6.25	158.8	2W-8437	
24.80	630.0	24.80	630.0	3.67	93.1	3.13	79.5	112-1665	
25.00	635.1	27.13	689.0	3.00	76.2	3.13	79.4	9Y-1403	
25.87	657.2	33.25	844.6	5.00	127.0	5.00	127.0	6N-0396*	
26.00	660.4	26.00	660.4	4.00	101.6	4.00	101.6	7E-2944	
26.00	660.4	31.02	788.0	4.13	104.8	4.00	101.6	7E-5663	
26.00	660.4	32.75	831.9	4.00	101.6	5.13	130.2	9S-7079*	
26.00	660.4	33.25	844.6	5.00	127.0	5.13	130.2	4N-4577*	
26.00	660.4	33.25	844.6	5.00	127.0	5.13	130.2	8S-6558	
26.00	660.4	33.25	844.5	5.00	127.0	5.13	130.2	7N-3235*	
26.00	660.4	34.75	882.7	3.50	88.9	4.13	104.8	2P-6255	
26.00	660.4	34.75	882.7	4.00	101.6	4.13	104.8	2P-2744	
26.00	660.4	36.93	938.0	5.00	127.0	5.13	130.2	4W-0455*	
26.00	660.4	36.93	938.0	5.00	127.0	5.13	130.2	4W-0456*	
26.00	660.4	37.50	952.5	6.00	152.4	6.13	155.6	8S-5438*	
26.00	660.4	37.50	952.5	6.00	152.4	6.13	155.6	8S-6443	

* Ejector is included with muffler.

Air Intake and Exhaust Systems

Mufflers

A BODY LENGTH (in) (mm)		B OVERALL LENGTH (in) (mm)		C INLET DIAMETER (in) (mm)		D OUTLET DIAMETER (in) (mm)		PART NUMBER	ADDITIONAL PARTS
26.00	660.4	38.86	987.0	5.00	127.0	6.13	155.6	1N-3452*	4P-6465 (1) - tube assy.
26.00	660.4	38.93	988.8	5.00	127.0	6.13	155.6	6N-0480*	
26.50	673.1	30.50	774.7	3.00	76.2	2.63	66.7	4N-6638	
27.44	697.0	41.76	1060.7	3.63	92.1	3.63	92.1	137-4097	
28.50	723.9	44.19	1122.4	2.50	63.5	2.63	66.7	7N-1659	
28.87	733.4	44.17	1122.0	3.00	76.2	2.63	66.7	1W-9832	
29.00	736.6	35.50	901.7	4.00	101.6	4.13	104.8	9S-8069	
29.00	736.6	36.62	930.2	5.00	127.0	6.00	152.4	6N-4184*	
29.00	736.6	38.50	977.9	5.00	127.0	6.13	155.6	7N-8923*	7N-8903 (1) - bracket assy. 0S-1588 (1) - cap screw 1D-4717 (1) - nut 5M-2894 (2) - washer
31.10	790.0	31.10	790.0	4.03	102.4	4.14	105.2	7Y-1508	
31.37	796.8	44.75	1136.6	8.00	203.2	8.13	206.4	7N-6905	
31.75	806.5	40.75	1035.0	6.63	168.3	6.63	168.3	7W-8445*	
31.75	806.4	41.50	1054.1	6.00	152.4	6.75	171.5	4N-5184	
31.75	806.5	43.25	1098.6	6.62	168.2	6.74	171.2	2P-2728	6F-7012 (2) - stud
31.75	806.5	43.25	1098.6	6.62	168.2	6.74	171.2	8S-6559	
31.75	806.4	43.25	1098.5	6.62	168.2	6.75	171.5	7N-4839*	
31.75	806.4	43.25	1098.5	6.62	168.2	6.75	171.5	7N-6021	
31.75	806.5	43.25	1098.6	6.63	168.3	6.75	171.5	8N-4975	
31.75	806.5	45.00	1143.0	6.62	168.2	6.74	171.2	9S-7786*	
32.50	825.5	42.91	1089.8	4.00	101.6	4.13	104.8	1W-0370	
35.00	889.0	38.49	977.6	3.00	76.2	3.13	79.4	7N-5539	
35.00	889.0	42.31	1074.7	5.00	127.0	6.00	152.4	7N-2187	
35.00	889.0	44.19	1122.5	3.00	76.2	3.13	79.4	1W-9519	
37.50	952.5	44.75	1136.6	5.04	128.0	6.04	153.4	4N-1565*	
38.00	965.2	44.94	1141.5	4.00	101.6	5.00	127.0	6N-4183*	
39.00	990.6	45.00	1143.0	6.00	152.4	6.00	152.4	2W-4072	2W-7861 (1) - flange 2W-7862 (1) - gasket 5L-4398 (6) - bolt 1B-5357 (6) - nut 5P-8245 (12) - washer
40.50	1028.7	43.88	1114.5	6.62	168.2	6.73	171.0	7N-9647	
42.00	1066.8	54.00	1371.6	10.00	254.0	10.19	258.8	7E-6811	
42.50	1079.5	50.50	1282.7	6.00	152.4	6.00	152.4	2P-3890	
45.49	1155.5	62.81	1595.5	6.00	152.4	5.13	130.2	7W-7181	
59.44	1509.8	62.75	1593.9	6.00	152.4	5.13	130.2	7W-7182	

* Ejector is included with muffler.

Air Intake and Exhaust Systems



Pre-Cleaners

With a pre-cleaner, your engine's air intake system will be protected in extremely dusty conditions.

- Constructed of a clear plastic cover for constant visual checks on dirt accumulation.
- For use with both turbocharged and naturally-aspirated engines.

ITEM	INTAKE DIAMETER		PART NUMBER
	(in)	(mm)	
Pre-Cleaner	2.50	63.5	130-6854
Pre-Cleaner	3.04	77.2	9Y-9431
Pre-Cleaner	3.04	77.2	118-6948
Pre-Cleaner	3.04	77.2	8H-2021
Pre-Cleaner	4.00	101.6	121-7746
Pre-Cleaner	4.00	101.6	129-8456
Pre-Cleaner	4.00	101.6	130-6856
Pre-Cleaner	4.00	101.6	4M-0310
Pre-Cleaner	4.00	101.6	3S-2953
Pre-Cleaner	4.00	101.6	2Y-8931
Pre-Cleaner	4.50	114.3	130-6858
Pre-Cleaner	4.50	114.3	130-6857
Pre-Cleaner	5.00	127.0	124-3237
Pre-Cleaner	5.00	127.0	130-6859
Pre-Cleaner	5.00	127.0	4W-2275
Pre-Cleaner	6.00	152.4	2S-5651
Pre-Cleaner	6.00	152.4	4S-7455
Pre-Cleaner	7.00	177.8	4W-7263
Pre-Cleaner	7.00	177.8	7N-5974
Pre-Cleaner Cap/Hood	9.06	230.1	7S-9396
Pre-Cleaner Cap/Hood	11.00	279.4	7S-8817

Pre-Cleaner Plastic Bowls

ITEM	OUTSIDE DIAMETER		PART NUMBER
	(in)	(mm)	
Pre-Cleaner Plastic Bowl	7.25	184.2	8H-2023
Pre-Cleaner Plastic Bowl	10.50	266.7	1M-7250
Pre-Cleaner Plastic Bowl	11.94	303.2	6H-8021
Pre-Cleaner Plastic Bowl	15.94	404.9	2S-6708

Air Intake and Exhaust Systems

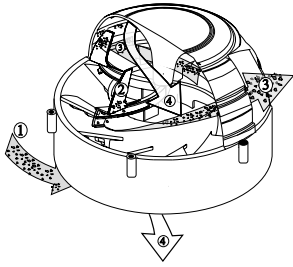

Turbine PreCleaners

Air filter life is directly related to the amount of debris ingested through an engine air intake. Installing a Cat Turbine PreCleaner as the first stage of an air intake system prevents the majority of heavier-than-air particles from entering the system. This results in a longer air filter life, improved fuel economy, higher performance and lower maintenance costs.

MODEL	PRE-CLEANER	INSTALLATION KIT	SCREEN KIT
Agricultural Tractors			
35	070-0107	+	153-1277
45	130-3280	+	153-1277
55	130-3280	+	153-1277
65	070-0107	+	153-1277
65B	130-3280	+	153-1277
65D*	070-0107	+	153-1277
65E*	130-3280	+	153-1277
65E	070-0107	+	153-1277
75	130-3280	+	153-1277
75D	130-3280	+	153-1277
75E	130-3281	+	153-1278
85	130-3280	+	153-1277
85D	130-3281	+	153-1278
85E	130-3281	+	153-1278
95E	130-3281	+	153-1278
Articulated Trucks			
D20D	130-3280	+	153-1277
D25C	130-3280	206-7515	153-1277
D25D	130-3280	206-7515	153-1277
D30C	130-3280	206-7515	153-1277
D30D	130-3280	206-7515	153-1277
D35 HP	130-3280	206-7515	153-1277
D35C	130-3280	206-7515	153-1277
D40D	130-3281	206-7517	153-1278
D44B	130-3281	206-7517	153-1278
D250B	130-3280	206-7515	153-1277
D250C	070-0107	206-7515	153-1277
D250C	130-3280	206-7515	153-1277
D250D	130-3280	206-7515	153-1277
D250E	130-3280	+	153-1277
D250E Series II	130-3280	206-7515	153-1277
D300B	130-3280	206-7515	153-1277
D300C	130-3280	206-7515	153-1277
D300D	130-3280	206-7515	153-1277
D300E	130-3280	206-7515	153-1277
D300E Series II	130-3280	206-7515	153-1277

MODEL	PRE-CLEANER	INSTALLATION KIT	SCREEN KIT
D350C	070-0107	206-7515	153-1277
D350D	070-0107	206-7515	153-1277
D350E	070-0107	206-7515	153-1277
D350E Series II	130-3280	206-7515	153-1277
D400	130-3281	206-7517	153-1278
D400D	130-3281	206-7517	153-1278
D400E	130-3281	206-7517	153-1278
D400E Series II	130-3281	206-7517	153-1278
D550B	130-3281	206-7517	153-1278
Backhoe Loaders			
416	143-7753	+	+
416B	143-7753	+	+
426	143-7753	+	+
426B	143-7753	+	+
428	143-7753	+	+
428B	143-7753	+	+
436C	143-7753	+	+
438	143-7753	+	+
438B	143-7753	+	+
446	143-7753	+	+
446B	143-7753	+	+
Excavators			
205 LC	143-7753	+	+
206	143-7753	+	+
211 LC	143-7753	+	+
212	143-7753	+	+
213B LC	130-3279	116-0401	153-1276
214	143-7753	+	+
214B	130-3279	116-0401	153-1276
215B	130-3279	116-0401	153-1276
215C	130-3279	116-0401	153-1276
219C	130-3279	116-0401	153-1276
224	130-3279	116-0401	153-1276
225	130-3279	116-0401	153-1276
225B	130-3279	116-0401	153-1276
225D	130-3279	116-0401	153-1276
225D LC	130-3279	116-0401	153-1276

* Recommended for use with an ag screen.

** Recommended for use with a forestry screen.

+ Customized installation available.

Air Intake and Exhaust Systems

Turbine PreCleaners

MODEL	PRE-CLEANER	INSTALLATION KIT	SCREEN KIT
Excavators (cont.)			
229	130-3280	+	153-1277
231D	130-3280	+	153-1277
235B	130-3280	+	153-1277
235C	130-3280	+	153-1277
245	130-3280	+	153-1277
245B	070-0107	116-0405	153-1277
311	143-7753	+	+
312	130-3279	116-0401	153-1276
330B	130-3280	+	153-1277
345	130-3280	206-7515	153-1277
350	130-3280	+	153-1277
350L	130-3280	+	153-1277
375	130-3281	+	153-1278
375	130-3280	+	153-1277
375L	130-3281	+	153-1278
E70	143-7753	+	+
E110B	130-3279	116-0400	153-1276
E120	143-7753	+	+
E120B	130-3279	+	+
E140	130-3279	116-0401	153-1276
E200B	130-3279	116-0401	153-1276
E240B	130-3279	116-0401	153-1276
E240C	130-3279	116-0401	153-1276
E300B	130-3280	+	153-1277
E450	130-3280	+	153-1277
EL240B	130-3279	116-0401	153-1276
EL240C	130-3279	116-0401	153-1276
EL300B	130-3280	+	153-1277
Forest Machines			
508	143-7753	+	+
515	070-0195	116-0401	153-1276
518**	130-3279	116-0401	153-1276
518	130-3279	116-0401	153-1276
525	130-3280	+	153-1277
528	130-3280	+	153-1277
D4 TSK HIII	130-3279	116-0401	153-1276
D5 TSK HII	130-3279	116-0401	153-1276
Front-Shovel Excavators			
5080 FS	130-3281	206-7517 (2)	153-1278 (2)
5130 FS	130-3281	206-7518 (2)	153-1278 (2)
5130 ME	130-3281	206-7518 (2)	153-1278 (2)

MODEL	PRE-CLEANER	INSTALLATION KIT	SCREEN KIT
Integrated Toolcarriers			
IT12	130-3279	116-0400	153-1276
IT12F	130-3279	116-0401	153-1276
IT14B	130-3279	116-0400	153-1276
IT14G	130-3279	116-0401	153-1276
IT18	130-3279	116-0401	153-1276
IT18B	130-3279	116-0401	153-1276
IT18F	130-3279	116-0401	153-1276
IT24F	070-0195	116-0401	153-1276
IT28	130-3279	116-0401	153-1276
IT28B	130-3279	116-0401	153-1276
IT28F	070-0195	116-0401	153-1276
IT28G	070-0195	116-0401	153-1276
IT38F	070-0195	116-0401	153-1276
IT38G	130-3280	+	153-1277
IT62G	130-3280	+	153-1277
Landfill Compactors			
816B	130-3280	206-7515	153-1277
826B	130-3280	206-7517	153-1277
826C	130-3280	206-7515	153-1277
826C	130-3281	206-7517	153-1278
826G	130-3281	206-7517	153-1278
836	130-3282	206-7517	153-1278
Lift Trucks			
DP30	143-7753	+	+
DP40	143-7753	+	+
DP45	143-7753	+	+
R80	130-3279	116-0400	153-1276
RC60	130-3279	116-0400	153-1276
Motor Graders			
12G	130-3279	116-0402	153-1276
12H	130-3279	+	153-1276
12H	130-3280	+	153-1277
14G	130-3280	206-7515	153-1277
14H	130-3280	206-7515	153-1277
16	130-3279	116-0401	153-1276
16G	130-3280	206-7515	153-1277
16H	130-3281	206-7517	153-1278
24H	130-3282	+	153-1278
130G	130-3280	+	153-1277
135H	130-3280	206-7515	153-1277
135H VHP	130-3280	206-7515	153-1277
140B	130-3280	206-7515	153-1277

* Recommended for use with an ag screen.

** Recommended for use with a forestry screen.

+ Customized installation available.

Air Intake and Exhaust Systems

Turbine PreCleaners

MODEL	PRE-CLEANER	INSTALLATION KIT	SCREEN KIT
Motor Graders (cont.)			
140G	130-3280	206-7515	153-1277
140G VHP	130-3280	206-7515	153-1277
140H	130-3280	206-7515	153-1277
140H VHP	130-3280	206-7515	153-1277
143H	130-3280	+	153-1277
160G	130-3280	206-7515	153-1277
160H	130-3280	206-7515	153-1277
160H VHP	130-3280	206-7515	153-1277
163H	130-3280	+	153-1277
Off-Highway Trucks			
768C	130-3280	+	153-1277
769B	130-3280	+	153-1277
769C	130-3280	+	153-1277 (2)
769D	130-3280	+	153-1277 (2)
771C	130-3280	+	153-1277
771D	130-3280	+	153-1277 (2)
773	130-3281	206-7517	153-1278
773B	130-3280	+	153-1277 (2)
773D	130-3281	+	153-1278 (2)
775B	130-3281	+	153-1278 (2)
775D	130-3281	+	153-1278 (2)
776B	130-3281	+	153-1278 (2)
777	130-3281	+	153-1278 (2)
777D	130-3282	+	153-1278 (2)
785	130-3282	+	153-1278 (2)
785B	130-3282	+	153-1278 (2)
789	130-3281	+	153-1278 (2)
789B	130-3281	+	153-1278 (2)
793	130-3281	+	153-1278 (4)
793B	130-3281	+	153-1278 (4)
793C	130-3281	+	153-1278 (4)
Paving Product - Asphalt Pavers			
AP800B	143-7753	+	+
AP1000	130-3279	116-0401	153-1276
AP1050	130-3279	116-0401	153-1276
Paving Product - Cold Planers			
PR75	130-3279	116-0400	153-1276
PR105	130-3279	116-0401	153-1276
PR250	130-3280	+	153-1277
PR275	130-3280	+	153-1277
PR450C	130-3281	+	153-1278
PR565	130-3281	+	153-1278

MODEL	PRE-CLEANER	INSTALLATION KIT	SCREEN KIT
PR750B	130-3280	+	153-1277 (2)
PR1000D	130-3280	+	153-1277
PR1000GD	130-3280	+	153-1277 (2)
Paving Product - Road Reclaimers/Soil Stabilizers			
RR250	130-3280	+	153-1277
SS250	130-3280	+	153-1277
Paving Product - Vibratory Compactors			
CB314	143-7753	+	+
CB434	143-7753	+	+
CB534	130-3279	116-0400	153-1276
CB634	130-3279	116-0401	153-1276
CP323	143-7753	+	+
CP433B	143-7753	+	+
CP553	070-0195	116-0401	153-1276
CP563	130-3279	116-0401	153-1276
CS323	143-7753	116-0400	+
CS431B	143-7753	116-0400	+
CS433B	143-7753	+	+
CS551	130-3279	116-0401	153-1276
CS553	130-3279	116-0401	153-1276
CS563	130-3279	116-0401	153-1276
CS583	130-3279	116-0401	153-1276
Pipelayers			
561D	130-3279	116-0401	153-1276
561H	130-3279	116-0401	153-1276
571G	130-3280	206-7515	153-1277
572G	130-3280	206-7515	153-1277
578	130-3281	206-7517	153-1278
583K	130-3280	206-7515	153-1277
589	130-3281	206-7517	153-1278
591	130-3281	206-7518	153-1278
594H	130-3281	206-7517	153-1278
Scrapers			
613B	130-3280	+	153-1277
613C	130-3280	+	153-1277
615	130-3280	206-7515	153-1277
615C	130-3280	206-7515	153-1277
619	130-3280	+	153-1277
621	130-3280	206-7515	153-1277
621B	130-3281	206-7517	153-1278
621E	130-3281	206-7517	153-1278
621F	130-3281	206-7517	153-1278
623	130-3280	+	153-1277

* Recommended for use with an ag screen.

** Recommended for use with a forestry screen.

+ Customized installation available.

Air Intake and Exhaust Systems

Turbine PreCleaners

MODEL	PRE-CLEANER	INSTALLATION KIT	SCREEN KIT
Scrapers (cont.)			
623B	130-3281	206-7517	153-1278
623E	130-3281	206-7517	153-1278
623F	130-3281	206-7517	153-1278
627B Front	130-3280	206-7515	153-1277
627B Rear	130-3280	+	153-1277
627E Front	130-3281	206-7517	153-1278
627E Rear	130-3280	+	153-1277
627F Front	130-3281	206-7517	153-1278
627F Rear	130-3280	206-7515	153-1277
627R	130-3280	+	153-1277
630	130-3280	+	153-1277 (2)
631	130-3281	206-7517	153-1278
631B	130-3281	206-7517	153-1278
631D	130-3281	206-7517	153-1278
631E	130-3281	206-7517	153-1278
631E Series II	130-3281	206-7517	153-1278
632	130-3281	206-7517	153-1278
633C	130-3281	206-7517 (2)	153-1278 (2)
633D	130-3281	206-7517	153-1278
633E	130-3281	206-7517	153-1278
634E Front	130-3281	206-7517	153-1278
637D Front	130-3281	206-7517	153-1278
637D Rear	130-3280	+	153-1277
637E Front	130-3281	206-7517	153-1278
637E Rear	130-3280	+	153-1277
639D Front	130-3281	206-7517	153-1278
639D Rear	130-3280	+	153-1277
641	130-3281	206-7517	153-1278
650	130-3282	206-7517	153-1278
651B	130-3282	206-7518	153-1278
651E	130-3282	206-7518	153-1278
657B Front	130-3282	206-7518	153-1278
657B Rear	130-3281	206-7518	153-1278
657E Rear	130-3281	206-7518	153-1278
666	130-3282	206-7517	153-1278
DW10	130-3279	116-0401	153-1276
DW10	130-3279	116-0400	153-1276
DW15	130-3279	116-0401	153-1276
DW20	130-3279	116-0401	153-1276
DW21	130-3279	116-0401	153-1276
Skid Steer Loader			
236	130-3280	+	153-1277

* Recommended for use with an ag screen.

** Recommended for use with a forestry screen.

MODEL	PRE-CLEANER	INSTALLATION KIT	SCREEN KIT
Soil Compactors			
815B	130-3280	206-7515	153-1277
815F	130-3280	206-7515	153-1277
816F	130-3280	206-7515	153-1277
825C	130-3281	206-7517	153-1278
825G	130-3281	206-7517	153-1278
Track Loaders			
931	143-7753	+	+
931B	143-7753	+	+
931C	143-7753	+	+
933	143-7753	+	+
933 LGP	143-7753	+	+
935C	143-7753	+	+
941	130-3279	116-0401	153-1276
943	143-7753	+	+
943	130-3279	116-0400	153-1276
951	130-3279	116-0401	153-1276
953	130-3279	116-0401	153-1276
953B	130-3279	116-0401	153-1276
953C	130-3280	+	153-1277
955H	130-3279	116-0401	153-1276
955L	130-3279	116-0401	153-1276
963	130-3279	116-0401	153-1276
963B	130-3280	+	153-1277
973	130-3280	+	153-1277
977K	130-3280	+	153-1277
977L	070-0107	+	153-1277
983B	070-0107	206-7515	153-1277
Track-Type Tractors			
D3	143-7753	+	+
D3C	130-3279	+	+
D4	143-7753	+	+
D4C	130-3279	+	+
D4E	130-3279	116-0401	153-1276
D4E SA	130-3279	116-0401	153-1276
D4E SR	130-3279	116-0401	153-1276
D4H	130-3279	116-0401	153-1276
D5	130-3279	116-0401	153-1276
D5B	130-3279	116-0401	153-1276
D5C	130-3279	116-0401	153-1276
D5H	070-0195	+	153-1276
D5M	070-0195	+	153-1276
D6	130-3280	+	153-1277

+ Customized installation available.

Air Intake and Exhaust Systems

Turbine PreCleaners

MODEL	PRE-CLEANER	INSTALLATION KIT	SCREEN KIT
Track-Type Tractors (cont.)			
D6B	130-3279	116-0401	153-1276
D6C	130-3279	116-0401	153-1276
D6D	130-3280	+	153-1277
D6D SA	130-3280	+	153-1277
D6E	130-3280	+	153-1277
D6E SR	130-3280	+	153-1277
D6H	130-3280	191-8285	153-1277
D6M	130-3280	191-8285	153-1277
D6R	130-3280	191-8285	153-1277
D7	130-3280	206-7515	153-1277
D7E	130-3280	+	153-1277
D7F	130-3280	206-7515	153-1277
D7G	130-3280	192-4095	153-1277
D7H	130-3280	192-4095	153-1277
D7R	130-3280	192-4095	153-1277
D8H	130-3280	206-7515	153-1277
D8K	130-3280	206-7515	153-1277
D8L	130-3281	206-7517	153-1278
D8N	130-3281	163-5750	153-1278
D8R	130-3281	163-5748	153-1278
D9	130-3279	116-0401 (2)	153-1276 (2)
D9G	130-3281	206-7517	153-1278
D9H	130-3281	206-7517	153-1278
D9L	130-3282	+	153-1278
D9N	130-3281	109-5199	153-1278
D9R	130-3281	109-5199	153-1278
D9R WHA	130-3282	109-5199	153-1278
D10	130-3281	150-0316 (2)	153-1278 (2)
D10N	130-3282	150-0316	153-1278
D10R	130-3282	150-0316	153-1278
D10R WHA	130-3282	150-0316	153-1278
D11N	130-3281	154-2386 (2)	153-1278 (2)
D11R	130-3281	154-2386 (2)	153-1278 (2)
Wheel Loaders			
910	143-7753	+	+
910E	130-3279	116-0400	153-1276
910F	130-3279	116-0401	153-1276
914G	130-3279	116-0400	153-1276
916	130-3279	116-0401	153-1276
918	130-3279	116-0401	153-1276
918F	130-3279	116-0401	153-1276
920	130-3279	116-0401	153-1276

* Recommended for use with an ag screen.

** Recommended for use with a forestry screen.

MODEL	PRE-CLEANER	INSTALLATION KIT	SCREEN KIT
924F	130-3279	116-0401	153-1276
924G	130-3279	+	153-1276
926	130-3279	116-0401	153-1276
926E	130-3279	116-0401	153-1276
928F	070-0195	116-0401	153-1276
928G	130-3280	+	153-1276
930	130-3279	116-0401	153-1276
936	070-0195	116-0401	153-1276
936E	070-0195	116-0401	153-1276
936F	070-0195	116-0401	153-1276
938	130-3280	+	153-1277
938F	070-0195	116-0401	153-1276
938G	130-3280	+	153-1277
944	130-3280	+	153-1277
950	130-3280	+	153-1277
950B	070-0195	116-0401	153-1276
950C	070-0195	116-0401	153-1276
950D	070-0195	116-0401	153-1276
950E	070-0195	116-0401	153-1276
950F	070-0195	116-0400	153-1276
950G	130-3280	+	153-1277
960F	130-3280	+	153-1277
960G	130-3280	+	153-1277
962G	130-3280	+	153-1277
966	130-3280	+	153-1277
966C	070-0107	+	153-1277
966D	070-0107	206-7515	153-1277
966E	070-0107	206-7515	153-1277
966F	070-0107	206-7515	153-1277
966F Series II	070-0107	206-7515	153-1277
966G	130-3281	206-7517	153-1278
970	070-0107	206-7515	153-1277
970F	070-0107	206-7515	153-1277
970G	070-0107	206-7515	153-1277
972G	130-3281	206-7517	153-1278
980	070-0195	116-0401 (2)	153-1276 (2)
980B	070-0107	+	153-1277
980C	130-3281	206-7517	153-1278
980F	130-3281	206-7517	153-1278
980G	130-3281	206-7517	153-1278
988	130-3280	+	153-1277
988A	130-3280	+	153-1277
988B	130-3281	206-7517	153-1278

+ Customized installation available.

Air Intake and Exhaust Systems

Turbine PreCleaners

MODEL	PRE-CLEANER	INSTALLATION KIT	SCREEN KIT
<i>Wheel Loaders (cont.)</i>			
988F	130-3281	206-7517	153-1278
988F Series II	130-3282	206-7517	153-1278
990	130-3281	206-7517 (2)	153-1278 (2)
990 Series II	130-3281	206-7517 (2)	153-1278 (2)
992B	130-3281	206-7517 (2)	153-1278 (2)
992C	130-3281	206-7517 (2)	153-1278 (2)
992D	130-3281	206-7517 (2)	153-1278 (2)
992G	130-3282	206-7517 (2)	153-1278 (2)
994	130-3281	206-7517 (4)	153-1278 (4)
<i>Wheel Tractors</i>			
814B	130-3280	206-7515	153-1277
814F	130-3280	116-0405	153-1277
824C	130-3281	206-7517	153-1278
824G	130-3281	206-7517	153-1278
834B	130-3281	206-7517	153-1278
844	130-3281	206-7517 (2)	153-1278 (2)
854G	130-3281	206-7517 (2)	153-1278 (2)
<i>Windrow Elevators</i>			
WE601B	143-7753	+	+
WE851B	130-3279	116-0401	153-1276

* Recommended for use with an ag screen.

+ Customized installation available.

** Recommended for use with a forestry screen.

Air Intake and Exhaust Systems

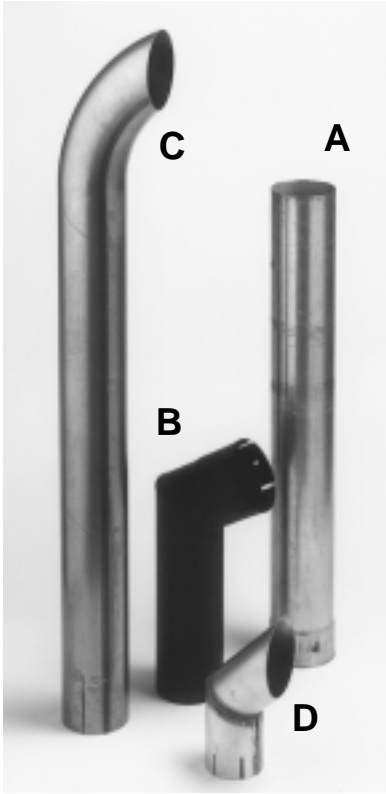

Exhaust Pipe Extensions

- Help remove exhaust, sound, and smoke from the operator's area.
- Not for use with an engine that has an air pre-cleaner with an exhaust-powered dust ejection system.

ITEM	OUTSIDE DIAMETER		LENGTH		PART NUMBER
	(in)	(mm)	(in)	(mm)	
Straight Pipe (A)	2.50	63.5	26.50	673.1	3B-6940
Straight Pipe (A)	3.00	76.2	23.00	584.2	8F-6403
Straight Pipe (A)	3.00	76.2	33.00	838.2	7B-3831
Straight Pipe (A)	3.00	76.2	62.00	1574.8	7M-5350
Straight Pipe (A)	3.25	82.6	35.50	901.7	1P-9554
Straight Pipe (A)	3.50	88.9	30.00	762.0	3H-8688
Straight Pipe (A)	3.63	92.2	28.74	730.0	6C-0027
Straight Pipe (A)	4.00	101.6	13.37	339.6	4N-6217
Straight Pipe (A)	4.00	101.6	27.50	698.5	9F-2838
Straight Pipe (A)	4.00	101.6	30.00	762.0	4H-7256
Straight Pipe (A)	4.00	101.6	33.50	850.9	4M-0810
Straight Pipe (A)	4.14	105.2	25.00	635.0	2P-6249
Straight Pipe (A)	4.50	114.3	30.00	762.0	1M-5270
Straight Pipe (A)	4.63	117.5	17.00	431.8	8S-8981
Straight Pipe (A)	4.63	117.5	27.50	698.5	9S-1768
Straight Pipe (A)	5.15	130.8	35.75	908.1	2P-1438
Straight Pipe (A)	5.25	133.4	30.00	762.0	8H-2718
Straight Pipe (A)	5.90	149.9	30.00	762.0	4S-6941
Straight Pipe (A)	6.62	168.2	31.38	797.1	9S-6120
Straight Pipe (A)	6.75	171.5	12.00	304.8	4N-6668
45° Outlet (B)	4.25	108.0	10.87	276.1	1P-8463
Radial Square Cut Outlet (C)	4.00	101.6	12.31	312.7	7N-2537
Radial Square Cut Outlet (C)	4.00	101.6	39.50	1003.3	2H-2191
Radial Square Cut Outlet (C)	4.50	114.3	28.30	718.8	7S-6742
Radial Square Cut Outlet (C)	4.50	114.3	46.00	1168.4	2S-4478
Radial Square Cut Outlet (C)	6.00	152.4	44.56	1131.8	1W-8415
Radial Square Cut Outlet (C)	6.00	152.4	49.88	1267.0	4N-5958
Radial Square Cut Outlet (C)	6.62	168.2	38.00	965.2	5D-0197
45° Square Cut Outlet (D)	3.16	80.3	9.80	248.9	9S-7534
45° Square Cut Outlet (D)	3.16	80.3	25.75	654.1	7S-7128
45° Square Cut Outlet (D)	3.16	80.3	44.30	1125.2	7S-7681
45° Square Cut Outlet (D)	4.00	101.6	11.28	286.5	2Y-8027
45° Square Cut Outlet (D)	4.24	107.7	26.62	676.2	2P-4611
45° Square Cut Outlet (D)	4.25	108.0	11.28	286.5	9S-6292
45° Square Cut Outlet (D)	4.38	111.3	40.00	1016.0	5M-5856
45° Square Cut Outlet (D)	4.52	114.8	26.19	665.2	7S-8736

Related parts, such as headware and braces, are not included with all exhaust pipe extensions. Please check the parts book for related part numbers.

Air Intake and Exhaust Systems

Exhaust Pipe Extensions

ITEM	OUTSIDE DIAMETER		LENGTH		PART NUMBER
	(in)	(mm)	(in)	(mm)	
45° Square Cut Outlet (D)	5.41	137.4	33.00	838.2	5D-1366
45° Square Cut Outlet (D)	5.50	139.7	37.40	950.0	8N-4445
45° Square Cut Outlet (D)	6.59	167.4	52.75	1339.9	7M-9877
45° Square Cut Outlet (D)	6.89	175.0	42.00	1066.8	9S-7290
45° Square Cut Outlet (D)	7.68	195.1	54.25	1378.0	5D-7771

Related parts, such as headware and braces, are not included with all exhaust pipe extensions. Please check the parts book for related part numbers.

Air Intake and Exhaust Systems



Air Intake Pipe Extensions

Intake extensions raise the air intake level to avoid low-lying dust concentrations.

- Provide cleaner air for your engine.
- Are easily installed between the pre-cleaner and the inlet pipe of the air cleaner.

ITEM	OUTSIDE DIAMETER		LENGTH		PART NUMBER
	(in)	(mm)	(in)	(mm)	
Air Intake Pipe Extension	3.25	82.6	27.50	698.5	7S-7117
Air Intake Pipe Extension	3.25	82.6	46.00	1168.4	8S-0985
Air Intake Pipe Extension (with clamp)	4.00	101.6	13.50	342.9	8S-2382
Air Intake Pipe Extension	4.00	101.6	30.00	762.0	7F-1499
Air Intake Pipe Extension	4.00	101.6	52.00	1320.8	1F-1342
Air Intake Pipe Extension	4.53	115.1	18.00	457.2	7H-0870
Air Intake Pipe Extension	5.00	127.0	13.50	342.9	8S-2381
Air Intake Pipe Extension	5.00	127.0	18.00	457.2	9H-8318
Air Intake Pipe Extension	5.00	127.0	45.00	1143.0	5H-7610
Air Intake Pipe Extension	5.91	150.1	45.00	1143.0	5D-5016
Air Intake Pipe Extension (with clamp)	6.58	167.1	13.50	342.9	8S-2383
Air Intake Pipe Extension (with clamp)	7.00	177.8	27.00	685.8	8S-8354
Air Intake Pipe Extension (with clamp)	9.00	228.6	13.35	339.1	8S-2384
Air Intake Pipe Extension (with clamp)	11.00	279.4	13.54	343.9	8S-2385

Air Intake and Exhaust Systems



Air Intake and Exhaust Stack Clamps

ITEM	DIAMETER		PART NUMBER
	(in)	(mm)	
Air Intake and Exhaust Stack Clamps	1.38	35.1	8M-4106
Air Intake and Exhaust Stack Clamps	1.50	38.1	1F-9774
Air Intake and Exhaust Stack Clamps	1.67	42.5	8M-7581
Air Intake and Exhaust Stack Clamps	1.75	44.5	8M-2325
Air Intake and Exhaust Stack Clamps	2.50	63.5	6B-3771
Air Intake and Exhaust Stack Clamps	2.66	67.6	2F-8299
Air Intake and Exhaust Stack Clamps	2.70	68.5	099-2062
Air Intake and Exhaust Stack Clamps	2.75	69.9	8N-9758
Air Intake and Exhaust Stack Clamps	3.00	76.2	8M-3121
Air Intake and Exhaust Stack Clamps	3.12	79.2	4K-2544
Air Intake and Exhaust Stack Clamps	3.14	79.8	2F-5152
Air Intake and Exhaust Stack Clamps	3.22	81.8	1W-5869
Air Intake and Exhaust Stack Clamps	3.28	83.3	5S-0580
Air Intake and Exhaust Stack Clamps	3.29	83.5	5A-8598
Air Intake and Exhaust Stack Clamps	3.67	93.3	3H-8604
Air Intake and Exhaust Stack Clamps	3.78	96.0	8F-5714
Air Intake and Exhaust Stack Clamps	4.09	103.9	2H-2190
Air Intake and Exhaust Stack Clamps	4.17	106.0	9S-8068
Air Intake and Exhaust Stack Clamps	4.31	109.5	9S-8071
Air Intake and Exhaust Stack Clamps	4.67	118.6	5A-8600
Air Intake and Exhaust Stack Clamps	5.17	131.4	2P-7806
Air Intake and Exhaust Stack Clamps	5.18	131.6	6F-8814
Air Intake and Exhaust Stack Clamps	5.25	133.4	8H-2758
Air Intake and Exhaust Stack Clamps	5.59	142.0	8M-0280
Air Intake and Exhaust Stack Clamps	6.00	152.4	5D-5017
Air Intake and Exhaust Stack Clamps	6.19	157.2	1N-4720
Air Intake and Exhaust Stack Clamps	6.32	160.5	8S-5444
Air Intake and Exhaust Stack Clamps	6.52	165.6	2R-1159
Air Intake and Exhaust Stack Clamps	6.77	171.9	5H-7292
Air Intake and Exhaust Stack Clamps	6.86	174.2	8S-1460
Air Intake and Exhaust Stack Clamps	7.04	178.8	5S-5327
Air Intake and Exhaust Stack Clamps	7.15	181.6	8S-1353
Air Intake and Exhaust Stack Clamps	7.28	185.0	7P-4595
Air Intake and Exhaust Stack Clamps	7.80	198.1	8M-1883
Air Intake and Exhaust Stack Clamps	8.16	207.3	4N-9330
Air Intake and Exhaust Stack Clamps	8.19	208.0	2P-7418
Air Intake and Exhaust Stack Clamps	8.40	213.4	1W-1305
Air Intake and Exhaust Stack Clamps	8.81	223.9	4W-1814
Air Intake and Exhaust Stack Clamps	10.46	265.8	6N-9298

Air Intake and Exhaust Systems



Rain Traps and Rain Caps

Rain traps and rain caps are made of heavy-gauge steel and are gravity-operated to provide low-cost protection for engine exhaust systems.

- Help keep rain, snow, and dirt from entering the exhaust manifold.
- Available for every Cat diesel and starting engine exhaust stack and for most other engines in your equipment spread.
- For use with both turbocharged and naturally-aspirated engines.
- Not for use with machines that have a muffler.

ITEM	EXHAUST STACK DIAMETER		PART NUMBER
	(in)	(mm)	
Rain Cap	1.25-1.44	32-36	7S-1724
Rain Trap	1.34-1.47	34-38	8F-3822
Rain Trap	1.47-1.59	37-41	8F-3825
Locking Rain Cap	1.50-1.69	38-43	7S-5004
Rain Trap	2.50-2.69	63-68	6F-6521
Locking Rain Cap	2.50-2.69	63-68	7S-4993
Rain Trap	3.00-3.19	76-81	6F-6522
Locking Rain Cap	3.00-3.19	76-81	7S-4992
Locking Rain Cap	3.22-3.41	82-87	8S-1935
Rain Trap	3.50-3.69	89-94	5H-2658
Locking Rain Cap	3.50-3.69	88-94	7S-4995
Rain Trap	4.00-4.19	101-106	5H-2722
Locking Rain Cap	4.00-4.19	102-106	7S-4994
Locking Rain Cap	4.50-4.69	114-119	7S-1784
Rain Cap	5.00-5.19	127-132	9S-7148
Locking Rain Cap	5.25-5.44	133-138	7S-4413
Rain Cap	5.50-5.69	140-144	7S-4410
Rain Cap	6.00-6.20	152-157	7S-4411
Rain Cap	6.14-6.30	156-160	3R-7698
Locking Rain Cap	6.75-6.94	171-176	7S-5003
Locking Rain Cap	6.88-7.07	175-180	8S-1417
Rain Cap	7.75-7.94	197-202	7S-4412
Rain Cap	8.00	203	6N-7611

A black and white photograph of a CAT battery. The battery is the central focus, with a prominent 'CAT' logo on its top surface. To the left, a headlight is visible, and in the foreground, a pair of wire cutters is positioned as if working on the battery. The background shows the engine compartment of a vehicle.

BATTERIES AND ELECTRICAL PARTS

Premium High Output Batteries	20
General Service Batteries	21
Battery Accessories	24
Emergency Start Systems	27
Composite Halogen Lights	29
Lamps	30
Fuses	35
Electrical Parts	37
Electrical Tools	43

Batteries and Electrical Parts



Premium High Output Batteries

- Provide three or more times the life of the best known battery brands.
- Deliver reliable starts due to high cold cranking amps (CCA) and reserve capacities (RC).
- Exceed the industry's most abusive vibration tests.
- Successfully recharge even after a radio or disconnect switch is left on for over 72 hours.

BCI GROUP SIZE	PART NUMBER	VOLTS	COLD CRANKING AMPS*	RESERVE CAPACITY MINUTES**	AMP HR. CAPACITY @ 20 HRS.	CONSTRUCTION
2	153-5690	6	765	210	90	Polypropylene Case, Low Antimony Calcium Design
4D	9X-9720	12	1000	275	140	Polypropylene Case, Low Antimony Calcium Design
4D	153-5700	12	1100	305	145	Polypropylene Case, Calcium Design (Wet only)
4D	9X-9730	12	1300	400	190	Polypropylene Case, Low Antimony Calcium Design
4D	153-5710	12	1365	425	200	Polypropylene Case, Calcium Design (Wet only)
8D	101-4000	12	1400	400	190	Polypropylene Case, Low Antimony Calcium Design
8D	153-5720	12	1465	465	210	Polypropylene Case, Calcium Design (Wet only)
24	153-5656	12	650	110	52	Polypropylene Case, Calcium Design (Wet only)
31	175-4360	12	660	185	100	Polypropylene Case, Calcium Design, Stud Terminals (Start/Cycling)
31	3T-5760	12	750	165	100	Polypropylene Case, Calcium Design (Wet only)
31	175-4370	12	780	190	100	Polypropylene Case, Calcium Design, Stud Terminals (Start/Cycling)
31	9X-3404	12	900	165	100	Polypropylene Case, Calcium Design (Wet only)
31	115-2421	12	950	170	90	Polypropylene Case, Calcium Design
31	115-2422	12	950	170	90	Polypropylene Case, Calcium Design (Wet only)
31	175-4390	12	950	180	90	Polypropylene Case, Calcium Design, Stud Terminals
58	175-4280	12	500	70	35	Polypropylene Case, Calcium Design
74	153-5660	12	650	110	52	Polypropylene Case, Calcium Design, Side Terminals (Wet only)

All batteries have taper post design and are shipped dry except as noted.

* For 30 seconds at 0° F

** 25 Amp output at 80° F

BCI GROUP SIZE	PART NUMBER	ADD WATER MAINTENANCE CHECK/HRS.	BCI OVERALL DIMENSIONS						NOMINAL WEIGHT				ACID TO FILL	
			LENGTH		WIDTH		HEIGHT		WET		DRY		TO FILL (qt)	(liter)
(in)	(mm)	(in)	(mm)	(in)	(mm)	(lbs)	(kg)	(lbs)	(kg)					
2	153-5690	1000	10.2	259	6.8	173	8.7	221	37	17	22	10	4.8	4.5
4D	9X-9720	1000	20.8	528	8.6	218	9.8	249	101	46	59	27	15.9	15.0
4D	153-5700	MF	20.8	528	8.8	224	9.8	249	101	46	—	—	—	—
4D	9X-9730	1000	20.8	528	8.6	218	9.8	249	119	54	81	37	14.8	14.0
4D	153-5710	MF	20.8	528	8.8	224	9.8	249	119	54				
8D	101-4000	1000	20.8	528	11.1	282	9.8	249	132	60	86	39	18.0	17.0
8D	153-5720	MF	20.8	528	11.1	282	9.8	249	132	60	—	—	—	—
24	153-5656	MF	10.2	259	6.8	173	8.9	226	39	18	—	—	—	—
31	175-4360	MF	13.0	330	6.8	173	9.4	239	60	27	—	—	—	—
31	3T-5760	MF	13.0	330	6.8	173	9.4	239	55	25	—	—	—	—
31	175-4370	MF	13.0	330	6.8	173	9.4	239	60	27	—	—	—	—
31	9X-3404	MF	13.0	330	6.8	173	9.4	239	58	26	—	—	—	—
31	115-2421	MF	13.0	330	6.8	173	9.4	239	60	27	44	20	6.6	6.2
31	115-2422	MF	13.0	330	6.8	173	9.4	239	60	27	—	—	—	—
31	175-4390	MF	13.0	330	6.8	173	9.4	239	60	27	—	—	—	—
58	175-4280	MF	9.3	236	7.2	183	7.0	178	31	14				
74	153-5660	MF	10.2	259	6.8	173	8.2	208	39	18	—	—	—	—

MF – Maintenance Free

Batteries and Electrical Parts

General Service Batteries (Dry)

BCI GROUP SIZE	PART NUMBER	VOLTS	COLD CRANKING AMPS*	RESERVE CAPACITY MINUTES**	AMP HR. CAPACITY @20 HRS.	CONSTRUCTION	BCI OVERALL DIMENSIONS LENGTH (in) WIDTH (in) HEIGHT (in)	NOMINAL WEIGHT WET (lbs) DRY (kg)	ACID TO FILL TO FILL (qt) (liter)
Agricultural / Industrial / Truck									
1	8T-9734	6	635	185	100	Maintenance Free, Calcium	9.0 229 8.8 175 224	32 15 17.5 8	4.5 4.3
3D	8T-9730	6	1400	675	320	Low Maintenance, Low Antimony Grids	20.4 518 10.0 221 254	120 54 84 38	11.0 10.4
7D	8T-9731	6	950	350	156	Low Maintenance, Low Antimony Grids	15.7 399 9.1 178 231	59.5 27 34 15	7.5 7.1
24F	9X-1382	12	660	110	50	Maintenance Free, Calcium Grids	10.6 269 9.0 173 229	38.5 17 25.5 12	6.0 5.7
26	145-4517	12	550	80	48	Maintenance Free, Calcium Grids	8.8 224 8.0 173 203	33 15 24 11	3.5 3.1
26R	145-4518	12	550	80	48	Maintenance Free, Calcium Grids	8.8 224 8.0 173 203	33 15 24 11	3.5 3.3
27	130-1978	12	530	85	61	Maintenance Free, Calcium Grids	12.0 305 9.0 173 229	45 20 28 13	6.5 6.2
27	3E-8925	12	700	120	55	Maintenance Free, Calcium Grids	12.0 305 9.0 170 229	45 20 29 13	6.5 6.2
27F	143-4084	12	530	85	61	Maintenance Free, Calcium Grids	12.0 305 9.0 173 229	45 20 28 13	6.5 6.2
Automotive / Light Truck									
22F	9X-1384	12	425	65	32	Maintenance Free, Calcium Grids	9.4 239 8.3 173 211	29.5 13 18 8	4.5 4.3
24	9X-1383	12	660	110	50	Maintenance Free, Calcium Grids	10.2 259 9.0 173 229	38.5 17 29 13	6.0 5.7
Marine / Recreational									
8V	8C-3640	8	980	350	175	Low Maintenance, Low Antimony Grids	20.8 527 10.6 184 270	90 41 60 27	11.5 10.9
Agricultural / Industrial / Truck									
1	8C-3617	6	645	154	100	Low Maintenance, Hybrid Construction	9.0 229 8.8 175 224	30 14 — —	— —
2	8C-3629	6	780	215	90	Low Maintenance, Low Antimony Grids	10.4 264 8.8 175 224	36.5 17 — —	— —
3	8C-3630	6	690	280	134	Low Maintenance, Low Antimony Grids	11.6 295 8.8 173 224	47 21 — —	— —

All batteries have taper post design and are shipped dry except as noted

* For 30 seconds at 0° F

** 25 Amp output at 80° F

Batteries and Electrical Parts

General Service Batteries (Wet — Available only for U.S. and U.S. export)

BCI GROUP SIZE	PART NUMBER	VOLTS	COLD CRANKING AMPS*	RESERVE CAPACITY MINUTES**	AMP HR. CAPACITY @20 HRS.	CONSTRUCTION	BCI OVERALL DIMENSIONS			NOMINAL WEIGHT		ACID TO FILL (qt) (liter)			
							LENGTH (in) (mm)	WIDTH (in) (mm)	HEIGHT (in) (mm)	WET (lbs) (kg)	DRY (lbs) (kg)				
Agricultural / Industrial / Truck (cont.)															
3EE	8C-3620	12	400	90	54	Low Maintenance, Low Antimony Grids	19.3	4.3	109	9	229	43	20	—	—
3EH	8C-3632	6	875	250	115	Low Maintenance, Low Antimony Grids	19.3	4.3	109	10.0	254	47.5	22	—	—
4	8C-3633	6	1000	270	125	Maintenance Free, Calcium Grids	12.5	6.9	175	9.5	241	47	21	—	—
4D	8C-3623	12	900	260	115	Low Maintenance, Low Antimony Grids	20.8	8.5	216	10.1	257	97	44	—	—
4DLT	8C-3622	12	860	250	100	Low Maintenance, Low Antimony Grids	20.0	8.2	208	8.2	208	79	36	—	—
7D	8C-3635	6	950	350	156	Low Maintenance, Low Antimony Grids	15.8	7.0	178	9.2	234	59.5	27	—	—
8D	8C-3624	12	1300	430	190	Low Maintenance, Low Antimony Grids	20.7	11.0	279	10.0	254	131.5	60	—	—
24F	3T-5858	12	660	110	55	Maintenance Free, Calcium Grids	10.6	6.8	173	9.0	229	38.5	17	—	—
27	8C-3601	12	700	120	65	Maintenance Free, Calcium Grids	12.0	6.7	170	9.0	229	45	20	—	—
27F	8C-3602	12	700	120	65	Maintenance Free, Calcium Grids	12.4	6.7	170	9.0	229	45	20	—	—
29H, 30H	8C-3627	12	800	185	100	Maintenance Free, Calcium Grids	13.0	6.8	173	9.5	241	57.5	26	—	—
31	8C-3628	12	760	170	80	Maintenance Free, Calcium Grids (Stud terminals)	13.0	6.8	173	9.5	241	54.5	25	—	—
31	100-4081	12	960	190	110	Maintenance Free, Calcium Grids (Stud terminals)	13.0	6.8	173	9.5	241	59	27	—	—
Automotive / Light Truck															
22F	3T-5859	12	425	65	35	Maintenance Free, Calcium Grids	9.4	6.8	173	8.3	211	29.5	13	—	—
24	3T-5857	12	660	110	55	Maintenance Free, Calcium Grids	10.2	6.8	173	9.0	229	38.5	17	—	—

All batteries have taper post design and are shipped dry except as noted

* For 30 seconds at 0° F

** 25 Amp output at 80° F

Batteries and Electrical Parts

General Service Batteries (Wet — Available only for U.S. and U.S. export)

BCI GROUP SIZE	PART NUMBER	VOLTS	COLD CRANKING AMPS*	RESERVE CAPACITY MINUTES**	AMP HR. CAPACITY @20 HRS.	CONSTRUCTION	BCI OVERALL DIMENSIONS LENGTH (in) (mm)	WIDTH (in) (mm)	HEIGHT (in) (mm)	NOMINAL WEIGHT WET (lbs) (kg)	DRY (lbs) (kg)	ACID TO FILL (qt) (liter)
Automotive / Light Truck (cont.)												
26	8C-3600	12	525	80	45	Maintenance Free, Calcium Grids	8.8	6.8	8.0	29	13	—
41	8C-3605	12	660	110	64	Maintenance Free, Calcium Grids	11.5	6.9	175	37	17	—
55, 56 62	8C-3611	12	585	95	52	Maintenance Free, Calcium Grids	8.8	6.0	216	33	15	—
58	8C-3612	12	560	80	53	Maintenance Free, Calcium Grids	10.0	7.2	175	30.5	14	—
65	9X-5408	12	880	150	80	Maintenance Free, Calcium Grids	12.0	7.4	193	45.5	21	—
75	7X-6100	12	720	100	60	Maintenance Free, Calcium Grids (Side terminals)	9.0	7.0	185	34.5	16	—
Dual Terminal Offering												
24, 24F 74	127-0824	12	875	120	63	Maintenance Free, Calcium Grids	10.9	7.0	229	44	20	—
34, 78	127-0826	12	850	120	66	Maintenance Free, Calcium Grids	10.8	6.9	203	41	19	—
Marine / Recreational												
GC-2	8C-3641	6		75 amps@80° 115	215	Deep Cycle, Antimony Grids (Offset post with horizontal hole)	10.3	7.1	277	63	29	—
U1	8C-3636	12	260	32	25	Maintenance Free, Calcium Grids (L-Terminal)	7.8	5.1	185	16.5	7	—
24M	8C-3638	12	660	110	55	Marine Starting, Maintenance Free, Calcium Grids (Stud terminals)	10.8	6.8	239	38.5	17	—
27M	8C-3639	12	600	150	80	Deep Cycle, Antimony Grids (Stud terminals)	12.5	6.8	239	49	22	—

All batteries have taper post design and are shipped dry except as noted

* For 30 seconds at 0° F

** 25 Amp output at 80° F

Batteries and Electrical Parts



Digital Battery Analyzer

- Used to test the condition (full state charge, voltage) of 6 and 12 volt batteries quickly and accurately, even when discharged to as low as one volt.
- Tests batteries in the machine or vehicle without disconnecting battery cables.

ITEM	PART NUMBER
Digital Battery Analyzer	177-2330



Battery Load Tester

- Measures voltage and amps for 6, 8, and 12 volt batteries.
- Measures voltage to one-hundredth of a volt and has a 1000 amp load capacity.

ITEM	PART NUMBER
Battery Load Tester	4C-4911



Battery Voltmeter

- Designed to determine the state of charge of 6 to 60 volt batteries quickly on or off the machine.
- Can be used in place of a hydrometer and will work on all batteries including sealed maintenance free batteries.

ITEM	PART NUMBER
Battery Voltmeter	4C-6600

Batteries and Electrical Parts



Coolant and Battery Tester

- Used for checking coolant freezing point and battery charge condition (specific gravity).
- Can also be used to check some types of permanent antifreeze, such as Dowtherm 209 Coolant.
- For use on either hot or cold radiators.

ITEM	PART NUMBER
Coolant and Battery Tester (° F)	1U-7297
Coolant and Battery Tester (° C)	1U-7298



Battery Cable Terminals

ITEM	CABLE SIZE	PART NUMBER
Battery Cable Terminal (A Negative)	365	3S-6050
Battery Cable Terminal (A Negative)	365	9S-6333
Battery Cable Terminal (A Positive)	365	3S-6049
Battery Cable Terminal (A Positive)	365	3S-6051
Battery Cable Terminal (B Negative)	365	9S-5753
Battery Cable Terminal (B Negative)	365	9S-5755
Battery Cable Terminal (B Positive)	365	9S-5752
Battery Cable Terminal (B Positive)	365	9S-5754
Battery Cable Terminal (C 1/2" Hole)	365	1M-4986
Battery Cable Terminal (C 1/2" Hole)	365	1S-7251
Battery Cable Terminal (C 1/2" Hole)	365	5P-2600
Battery Cable Terminal (C 1/2" Hole)	366	3L-7634
Battery Cable Terminal (C 1/4" Hole)	365	030-1709
Battery Cable Terminal (C 1/4" Hole)	365	030-1706
Battery Cable Terminal (C 3/8" Hole)	365	030-1707
Battery Cable Terminal (C 3/8" Hole)	365	1S-7252
Battery Cable Terminal (C 3/8" Hole)	365	035-0425
Battery Cable Terminal (C 3/8" Hole)	366	031-9295
Battery Cable Terminal (C 5/16" Hole)	365	030-1708
Battery Cable Terminal (C 5/16" Hole)	365	030-1705

Batteries and Electrical Parts



Battery Ground Straps

ITEM	LENGTH		GROUND END HOLE		BATTERY END HOLE		PART NUMBER
	(in)	(mm)	(in)	(mm)	(in)	(mm)	
Battery Ground Strap	4.3	108	7/16	11	9/16	14	8M-4963
Battery Ground Strap	5.4	137	5/16	8	3/16	5	8L-8420
Battery Ground Strap	5.5	140	7/16	11	7/16	11	1S-2342
Battery Ground Strap	12.0	305	13/32	10	9/16	14	2L-6716
Battery Ground Strap	12.0	305	17/32	14	13/32	10	4M-7146
Battery Ground Strap	18.0	457	17/32	14	21/32	17	3R-2853



Battery Cable Repair Kit

- For use during cable fabrication and repair.
- For use with heavy 1/0 through 4/0 gauge electrical cables.

KIT PART NUMBER	ITEM	QUANTITY	PART NUMBER
6V-3025	Cable Repair Kit		
	Roto Crimping Tool	1	6V-3021
	Cable Cutter	1	6V-3022
	Box Assembly	1	6V-3023
	Butt Splice (4/0)	2	6V-3020
	Butt Splice (3/0)	3	6V-3019
	Butt Splice (2/0)	4	6V-3017
	Butt Splice (1/0)	3	6V-3018



Booster Cables

- Ensure quick and efficient connections.

ITEM	LENGTH		PART NUMBER
	(ft)	(m)	
Booster Cable	12.00	3.660	4C-4933
Booster Cable with "Safety Lite"	12.00	3.660	4C-4934
Booster Cable	15.00	4.570	4C-4935
Booster Cable	15.00	4.570	4C-4938
Booster Cable	20.00	6.000	4C-4936
Booster Cable	20.00	6.000	4C-4937



Emergency Start System

- Provides fast and easy starts to stalled direct electric start equipment.
- 10 ft. (2.45 m) plug assembly is used for starting stalled equipment from an auxiliary battery pack.
- 15 ft. (3.81 m) plug assembly is used for starting stalled equipment by jumping from another piece of equipment.

ITEM	PART NUMBER
Emergency Start System (10-foot Plug Assembly)	8S-2632
Emergency Start System (15-foot Plug Assembly)	9S-3664

Batteries and Electrical Parts



Emergency Jump Start Receptacle Assemblies

- Mount on the machine to provide a direct electrical connection to the starting motor.
- Available in several cable lengths to suit your particular application.
- For use with 8S-2632 or 9S-3664 Emergency Start Systems.

ITEM	LENGTH		PART NUMBER
	(ft)	(m)	
Emergency Jump Start Receptacle Assembly	1.25	0.380	9S-9015
Emergency Jump Start Receptacle Assembly	1.42	0.460	2G-1830
Emergency Jump Start Receptacle Assembly	4.00	1.220	8S-2633
Emergency Jump Start Receptacle Assembly	5.00	1.520	9S-9016
Emergency Jump Start Receptacle Assembly	6.00	1.820	4N-6580
Emergency Jump Start Receptacle Assembly	7.00	2.130	1P-1250
Emergency Jump Start Receptacle Assembly	9.00	2.680	4N-6579
Emergency Jump Start Receptacle Assembly	10.00	3.050	9S-9312
Emergency Jump Start Receptacle Assembly	12.00	3.660	9D-8647



Starting/Charging Analyzer Group

- Identifies deteriorating starting and charging system components before they fail.
- Contains a 5.5 m cable for testing from the operator's seat.

ITEM	PART NUMBER
Starting/Charging Analyzer Group	6V-2150

Batteries and Electrical Parts



Composite Halogen Lights

- Provide longer life and lower operating costs.
- Provide 30 to 35% more light output than conventional lights and maintain full light output over their lifetime.
- Provide easy replacement for existing conventional lights or may be added as additional lamp assemblies.
- Replacement bulbs fit all lamps of the same voltage.
- Standard on all new Cat production machines.

ITEM	SIZE	VOLTAGE	ELECTRICAL CONNECTOR	PART NUMBER	LENS ASSY.	BODY ASSY.	BEZEL	CLAMP	FACE SEAL	BULB
Suspended Flood	3X3	12	Blade Term.	142-8637	–	–	–	–	–	9W-0607
Suspended Flood	3X3	12	Pigtail DT (2)	201-1422	202-6611	202-6613	–	–	202-6612	9W-0607
Suspended Flood	3X3	12	Pigtail DT (2)	201-1423	202-6614	202-6613	–	–	202-6612	9W-0607
Vertical Flood	3X3	12	Blade Term.	168-6410	–	–	–	–	–	9W-0607
Surface Flood	3X5	12	Wire w/spade	105-8069	–	–	–	–	–	9W-0607
Suspended Flood	3X5	12	Pigtail DT (2)	105-8070	144-5284	144-5744	–	–	144-5283	9W-0607
Suspended Flood	3X5	12	Spade Term.	152-8180	155-5354	155-5355	–	–	–	9W-0607
Vertical Flood	3X5	12	Pigtail DT (2)	190-3753	144-5284	144-5744	–	–	144-5283	9W-0607
Surface Flood	3X5	24	Wire w/spade	109-7041	–	–	–	–	–	9X-3463
Suspended Flood	3X5	24	Pigtail DT (2)	112-9378	144-5284	144-5744	–	–	144-5283	9X-3463
Suspended Flood	3X5	24	Pigtail w/rings	117-3468	144-5284	144-5744	–	–	144-5283	9X-3463
Suspended Flood	3X5	24	Pigtail DT (2)	164-5499	144-5284	144-5744	–	–	144-5283	9X-3463
Vertical Flood	3X5	24	Pigtail DT (2)	135-5549	144-5284	144-5744	–	–	144-5283	9X-3463
Suspended Flood	5X5	12	Blade Term.	107-1301	107-1302	–	–	–	–	9W-0607
Vertical Flood	5X5	12	Screw Term.	9X-7779	9X-4174	9X-3455	–	–	9X-4243	9W-0607
Left Hand Flood	5X5	24	Screw Term.	166-8850	9X-4174	9X-3455	–	–	9X-4243	9X-3463
Suspended Flood	5X5	24	Screw Term.	106-8964	9X-4174	9X-3455	–	–	9X-4243	9X-3463
Suspended Flood	5X5	24	Screw Term.	126-7487	9X-4174	9X-3455	–	–	9X-4243	9X-3463
Suspended Flood	5X5	24	Pigtail DT (2)	176-0780	9X-4174	176-7214	–	–	9X-4243	9X-3463
Suspended Flood	5X5	24	Pigtail DT (2)	184-1104	9X-4174	176-7214	–	–	9X-4243	9X-3463
Vertical Flood	5X5	24	Screw Term.	122-6663	9X-4174	9X-3455	–	–	9X-4243	9X-3463
Vertical Flood	5X5	24	Pigtail DT (2)	172-9973	9X-4174	176-7214	–	–	9X-4243	9X-3463
Vertical Flood	5X5	24	Screw Term.	9X-1439	9X-4174	9X-3455	–	–	9X-4243	9X-3463
Vertical High Beam	5X5	12	Screw Term.	9X-8180	9X-7797	9X-3455	–	–	9X-4243	9W-0607
Vertical High Beam	5X5	24	Pigtail DT (2)	171-7214	9X-7797	176-7214	–	–	9X-4243	9X-3463
Vertical High Beam	5X5	24	Screw Term.	9X-1440	9X-4175	9X-7848	–	–	9X-9865	9X-7849
Vertical High Beam	5X5	24	Screw Term.	9X-1442	9X-4177	9X-7848	–	–	9X-9865	9X-7849
Vertical High Beam	5X5	24	Screw Term.	9X-7170	9X-7797	9X-3455	–	–	9X-4243	9X-3463
Vertical Low Beam	5X5	12	Screw Term.	9X-8179	9X-7798	9X-3455	–	–	9X-4243	9W-0607
Vertical Low Beam	5X5	24	Pigtail DT (2)	171-7213	9X-7798	176-7214	–	–	9X-4243	9X-3463
Vertical Low Beam	5X5	24	Screw Term.	9X-1441	9X-4176	9X-7848	–	–	9X-9865	9X-7849
Vertical Low Beam	5X5	24	Screw Term.	9X-7169	9X-7798	9X-3455	–	–	9X-4243	9X-3463
Vertical Low Beam LH	5X5	24	Screw Term.	9X-1444	9X-4179	9X-7848	–	–	9X-9865	9X-7849
Vertical Low Beam RH	5X5	24	Screw Term.	9X-1443	9X-4178	9X-7848	–	–	9X-9865	9X-7849
Vertical Stop	5X5	24	Screw Term.	6V-1108	6V-1120	9X-3455	–	–	9X-4243	9X-3463
Vertical Turn	5X5	24	Screw Term.	6V-1119	6V-1174	9X-3455	–	–	9X-4243	9X-3463
Suspended Flood	5X5 SR	24	Integral DT	147-0319	158-0248	158-0250	158-0252	188-8849	–	9X-3463
Vertical Flood	5X5 SR	24	Integral DT	153-2073	158-0248	158-0250	158-0252	188-8849	–	9X-3463
Vertical Flood	5X5 SR	24	Pigtail DT (2)	162-3294	158-0248	162-5372	158-0252	188-8849	–	9X-3463
Suspended Flood	5X5 SR	24	Pigtail DT (2)	171-2065	158-0248	162-5372	158-0252	188-8849	–	9X-3463
Suspended High Beam	5X5 SR	24	Integral DT	157-0305	158-0249	158-0250	158-0252	188-8849	–	9X-3463
Vertical High Beam	5X5 SR	24	Integral DT	180-1300	158-0249	158-0250	158-0252	188-8849	–	9X-3463
Suspended High Beam	5X5 SR	24	Pigtail DT (2)	168-1960	158-0249	162-5372	158-0252	188-8849	–	9X-3463
Vertical High Beam	5X5 SR	24	Pigtail DT (2)	171-2067	158-0249	162-5372	158-0252	188-8849	–	9X-3463
Suspended Low Beam	5X5 SR	24	Integral DT	161-0908	162-2077	158-0250	158-0252	188-8849	–	9X-3463
Vertical Low Beam	5X5 SR	24	Integral DT	161-3509	162-2077	158-0250	158-0252	188-8849	–	9X-3463
Vertical Low Beam	5X5 SR	24	Pigtail DT (2)	168-1953	162-2077	162-5372	158-0252	188-8849	–	9X-3463
Suspended Low Beam	5X5 SR	24	Pigtail DT (2)	171-2066	162-2077	162-5372	158-0252	188-8849	–	9X-3463

SR - Shock Resistant

Batteries and Electrical Parts



Sealed Beam Electrical Lamps

ITEM	VOLTAGE	ANSI NUMBER	WATTAGE	PART NUMBER
Dual Head Lamp	24	4579	80/60	1M-5899
Flood Lamp	6	4078	50	1M-5896
Flood Lamp	6	4219	30	1M-7361
Flood Lamp	12	4478	60	2M-4168
Flood Lamp	24	H4815	90	8T-9886
Flood Lamp	24	4578	60	1M-5898
Flood Lamp	24	4490A	50	110-3239
Flood Lamp (Halogen)	24	H4578	60	9W-1281
Flood Lamp (Screw Terminal)	12	4410	35	2P-7469
Flood Lamp (Screw Terminal)	24	4752	60	6N-7987
Fog Lamp	24	4402A	50	7G-9319
Head Lamp	12	7780	60	2M-4169
Head Lamp	24	4880	60	1M-5928
Head Lamp (Halogen)	24	H4880	60	9W-1280
Head Lamp (Screw Terminal)	24	4750	60	7N-7682
Hi/Lo Lamp	6	4031	45/35	1M-5897
Hi/Lo Lamp	12	4431	45/35	1H-7027
High Head Lamp	24	4814	90	5S-5149
High Head Lamp (Halogen)	24	H4814	90	8T-8753
Low Head Lamp	24	4813	90	5S-5150
Low Head Lamp (Halogen)	24	H4813	90	8T-8752
Spot Lamp	12	4416	30	069-2999
Spot Lamp	24	4505	50	7T-1371
Stop Lamp	24	4752R	60	7X-6220
Stop Lamp	24	4825R	50/18	6N-7982



LED Lights

- Provides extended life and increased vibration resistance.
- Uses less amperage than incandescent lights.
- Retrofittable to any 24-volt application.

ITEM	SHAPE	COLOR	PART NUMBER
Front Turn and Park	Rectangular	Amber	135-0427
Front Turn and Park	Round	Amber	135-0428
Stop and Tail Light	Rectangular	Red	135-0426
Stop and Tail Light	Round	Red	143-2014

Batteries and Electrical Parts

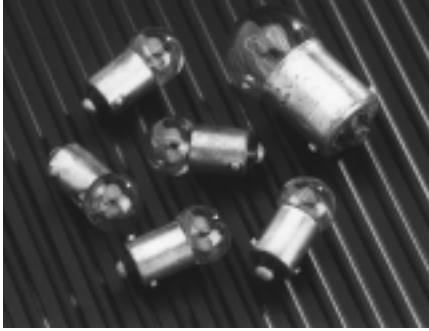

Miniature Electrical Lamps

ITEM	VOLTAGE	ANSI NUMBER	PART NUMBER
Miniature Electrical Lamp	6	63	9B-3117
Miniature Electrical Lamp	6	1154	8M-7119
Miniature Electrical Lamp	12	53	9M-6176
Miniature Electrical Lamp	12	53	8M-6176
Miniature Electrical Lamp	12	67	9W-2471
Miniature Electrical Lamp	12	93	1S-4168
Miniature Electrical Lamp	12	194	122-7137
Miniature Electrical Lamp	12	631	7M-9957
Miniature Electrical Lamp	12	1156	5M-8034
Miniature Electrical Lamp	12	1157	7S-1800
Miniature Electrical Lamp	12	1816	8L-9801
Miniature Electrical Lamp	12	1895	5D-0284
Miniature Electrical Lamp	14	194A	118-5075
Miniature Electrical Lamp	24	—	7N-9967
Miniature Electrical Lamp	24	265	7X-2058
Miniature Electrical Lamp	24	307	8J-4863
Miniature Electrical Lamp	24	356	5D-0019
Miniature Electrical Lamp	24	456	5D-1708
Miniature Electrical Lamp	24	459	9D-4185
Miniature Electrical Lamp	24	623	2D-1959
Miniature Electrical Lamp	24	624	7N-1996
Miniature Electrical Lamp	24	657	110-2079
Miniature Electrical Lamp	24	1251	3H-2691
Miniature Electrical Lamp	24	1309	9K-9140
Miniature Electrical Lamp	24	1495	9W-2111
Miniature Electrical Lamp	24	1638	8T-9749
Miniature Electrical Lamp	24	1662	034-2535
Miniature Electrical Lamp	24	1683	7H-2976
Miniature Electrical Lamp	24	1820	8D-1429
Miniature Electrical Lamp	24	1873	7N-5876
Miniature Electrical Lamp	24	2232	7N-9943
Miniature Electrical Lamp	24	2841	115-1748
Miniature Electrical Lamp	24	623R	9S-3335
Miniature Electrical Lamp	28	311	7D-8855
Miniature Electrical Lamp	28	327	3N-5719
Miniature Electrical Lamp	28	757	123-9294



Stop/Tail Lamps

ITEM	VOLTAGE	BODY ASSY.	STYLE
Compartment	24	101-0461	Rectangular
Compartment	24	171-5672	Rectangular
Position	24	162-5402	Rectangular
Position	24	9X-1407	Rectangular
Service Indicator	24	107-2282	Rectangular
Service Indicator	24	125-6794	Rectangular
Stop/Tail	12	9X-8196	Rectangular
Stop/Tail	24	107-4401	Rectangular
Stop/Tail	24	130-3452	Rectangular
Stop/Tail	24	130-3453	Rectangular
Stop/Tail (LED)	24	135-0426	Rectangular
Stop/Tail	24	3E-6467	Rectangular
Stop/Tail	24	9X-1404	Rectangular
Turn	12	3E-9346	Rectangular
Turn	12	9X-8242	Rectangular
Turn	24	107-4402	Rectangular
Turn	24	162-2073	Rectangular
Turn (LED)	24	199-3368	Rectangular
Turn (LED)	24	201-5464	Rectangular
Turn	24	3E-6466	Rectangular
Turn	24	7X-6066	Rectangular
Turn	24	9X-1406	Rectangular
Turn/Park	24	129-5688	Rectangular
Turn/Park (LED)	24	135-0427	Rectangular
Turn/Park	24	3E-7741	Rectangular
Payload	24	8T-9683	Round
Payload	24	8T-9684	Round
Stop/Tail (LED)	24	143-2014	Round
Stop/Tail	24	8C-6207	Round
Stop/Tail	24	9G-4358	Round
Stop/Tail	24	9G-8556	Round
Turn	24	7T-7818	Round
Turn	24	9D-4073	Round
Turn	24	9G-4357	Round
Turn/Park (LED)	24	135-0428	Round

Batteries and Electrical Parts

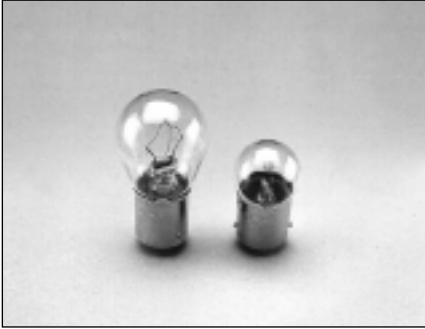





Dash Lamps

- Allow operators to read gauges at night.
- For use with miniature electrical lamps.

ITEM	VOLTAGE	WIRE LENGTH		BODY ASSY.	BULB
		(in)	(mm)		
Dash Lamp	6	36701	152 - 610	6N-8355	9B-3117
Dash Lamp	12	36701	152 - 610	6N-8355	7M-9957
Dash Lamp	24	36701	152 - 610	6N-8355	3H-2691

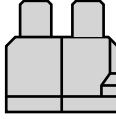
Batteries and Electrical Parts

Fuses

AMPERAGE	MAXIMUM VOLTAGE	FUSE DESC.	PART NUMBER	GRAPHIC
3A	250V	Time Delay Ferrule	9G-3782	
4A	250V	Time Delay Ferrule	9K-1896	
5A	500V	Time Delay Ferrule	5N-0095	
30A	32V	Time Delay Ferrule	6N-9353	
10A	32V	Plug Fuse	9W-1442	
15A	32V	Plug Fuse	9W-1441	
20A	32V	Plug Fuse	9W-1446	
30A	32V	Plug Fuse	8T-9636	
12A	250V	TRON Rectifier	7C-3882	
15A	130V	TRON Rectifier	3N-2050	
15A	250V	TRON Rectifier	3N-7807	
25A	600V	TRON Rectifier	7L-2760	
50A	600V	TRON Rectifier	7L-2765	
60A	600V	TRON Rectifier	7L-6745	
70A	600V	TRON Rectifier	7L-6750	
400A	150V	TRON Rectifier	039-6987	
50A	30VDC	Stud Mounted	3C-1064	
60A	125V	Stud Mounted	031-2436	
275A	30VDC	Stud Mounted	3C-0524	
300A	250V	Stud Mounted	030-1964	
325A	30VDC	Stud Mounted	3C-1572	
400A	250V	Stud Mounted	030-1696	
450A	250V	Stud Mounted	030-1698	
500A	250V	Stud Mounted	030-1699	
500A	30VDC	Stud Mounted	3C-0516	
600A	250V	Stud Mounted	039-6577	
600A	250V	Stud Mounted	030-1697	
60A	125V	Low Voltage Limiter	090-7012	
300A	125V	Low Voltage Limiter	090-7013	
675A	32V	Low Voltage Limiter	097-4224	
0.75A	250V	Ferrule	7T-0037	
1.25A	250V	Ferrule	034-3128	
1A	250V	Ferrule	8K-4644	
1A	600V	Ferrule	3N-5612	
2A	250V	Ferrule	8D-8724	
2A	250V	Ferrule	039-8989	
3A	32V	Ferrule	8M-0454	
3A	250V	Ferrule	8D-8113	
4A	60V	Ferrule	7N-0472	
4A	32V	Ferrule	8M-0457	
5A	32V	Ferrule	5A-3837	
5A	250V	Ferrule	2S-6024	
5A	600V	Ferrule	5N-5535	

Batteries and Electrical Parts

Fuses

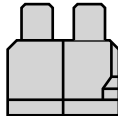
AMPERAGE	MAXIMUM VOLTAGE	FUSE DESC.	PART NUMBER	GRAPHIC
5A	250V	Ferrule	033-3672	
6A	250V	Ferrule	8M-0458	
6A	60V	Ferrule	3T-5802	
6A	250V	Ferrule	8D-9497	
6A	32V	Ferrule	9D-6032	
7.5A	250V	Ferrule	3K-8781	
7.5A	32V	Ferrule	8M-0455	
8A	32V	Ferrule	7D-4975	
10A	250V	Ferrule	9Y-6027	
10A	250V	Ferrule	3K-8782	
14A	32V	Ferrule	3D-4529	
15A	32V	Ferrule	8M-8948	
20A	32V	Ferrule	8M-0456	
25A	32V	Ferrule	3T-4425	
30A	32V	Ferrule	8M-8947	
5A	250VAC	General Purpose	5N-5532	
10A	250VAC	General Purpose	5N-5533	
12A	600V	LIMITRON	9Y-8419	
15A	250VAC	General Purpose	5N-5534	
60A	300VAC	SC Time-Lag	091-8556	
10A	32V	Mini	113-8490	
15A	32V	Mini	113-8491	
20A	32V	Mini	113-8492	
25A	32V	Mini	113-8493	

Batteries and Electrical Parts



Fuse Holders and Puller

ITEM	PART NUMBER
Dashmount Fuse Holder	4K-5122
In-Line Fuse Holder	051-4069
Fuse Block	5K-2849
Fuse Holder	7N-8292
Wire-to-Wire Fuse Holder	3K-8783
Wire-to-Wire Fuse Holder	8D-8719
Fuse Puller	116-7471



Pressure Switches

For use with engine oil pressure sensing or any application requiring setting switches.

ITEM	SWITCHING POINT		CONTACTS AT 0 kPa	PORT FITTING	ELECTRICAL CONNECTOR	PART NUMBER
	(psi)	(kPa)				
Pressure Switch	5.5 ± 3	37.9 ± 21	Open	1/4 NPTF	#8 Screws	3E-2026
Pressure Switch	10.0 ± 3	68.9 ± 21	Open	1/8 NPTF	#8 Screws	107-0611
Pressure Switch	10.0 ± 3	68.9 ± 21	Closed	1/8 NPTF	#8 Screws	107-0616
Pressure Switch	10.0 ± 3	68.9 ± 21	Open	1/4 NPTF	#8 Screws	107-0612
Pressure Switch	10.0 ± 3	68.9 ± 21	Open	9/16 UNF	Sure Seal	6T-4949
Pressure Switch	18.0 ± 3	124.0 ± 21	Open and Closed	9/16 UNF	Sure Seal	6T-6652
Pressure Switch	30.0 ± 4	207.0 ± 28	Open and Closed	9/16 UNF	Sure Seal	6T-6651
Pressure Switch	40.0 ± 4	276.0 ± 28	Open and Closed	9/16 UNF	Sure Seal	6T-6653

Batteries and Electrical Parts



Bulk Electrical Cable and Wire

ITEM	GAUGE	PACKAGE* LENGTH		PART NUMBER
		(ft)	(m)	
Lighting Wire	6	50	15	5P-5675
Lighting Wire	8	50	15	5P-5689
Lighting Wire	10	100	30	5P-5622
Lighting Wire	12	100	30	5P-5621
Lighting Wire	14	100	30	5P-5624
Lighting Wire	16	100	30	5P-5623
Lighting Wire	18	100	30	5P-5677
Starter Cable	Black 00	25	7.62	159-8050
Starter Cable	Black 000	25	7.62	159-8052
Starter Cable	Red 0	25	7.62	159-8047
Starter Cable	Red 00	25	7.62	159-8049
Starter Cable	Red 000	25	7.62	159-8051
Starter Cable	Red 0000	25	7.62	159-8053
Ignition Wire	N/A	25	7.62	5P-6036
Glow Plug Wire	No. 12	25	7.62	5P-6020

* Serviced in increments of their packaged length.



Electrical Terminals

ITEM	SCREW SIZE	WIRE SIZE	PART NUMBER
Blade Terminal	Female	16-14	5P-4571 (30)
Blade Terminal	Male	16-14	4S-1988 (10)
Butt Splices		16-14	136-4877 (15)
Ring Terminal	1/4"	8	2L-8058 (10)
Ring Terminal	1/4"	12-10	2L-8067 (10)
Ring Terminal	1/4"	16-14	2L-8077 (15)
Ring Terminal	3/8"	12-10	2L-8069 (10)
Ring Terminal	3/8"	16-14	2L-8079 (15)
Ring Terminal	1/2"	12-10	2L-8071 (10)
Ring Terminal	No. 10	12-10	2L-8076 (20)
Ring Terminal	No. 10	16-14	2L-8066 (10)
Ring Terminal	No. 8	16-14	2L-8075 (20)



Electrical Terminal Kit

- Contains 14 different types and sizes of terminals.
- Contains a multi-purpose crimping tool that performs all the steps required to install terminals.
- Eliminates the need for a soldering iron and insulating material.

KIT PART NUMBER	ITEM	QUANTITY	PART NUMBER
140-9944	Terminal Assortment		
	Ring Terminal	10	2L-8058
	Ring Terminal	10	2L-8066
	Ring Terminal	10	2L-8067
	Ring Terminal	10	2L-8069
	Ring Terminal	10	2L-8071
	Ring Terminal	20	2L-8075
	Ring Terminal	20	2L-8076
	Ring Terminal	15	2L-8077
	Ring Terminal	15	2L-8079
	Blade Terminal	10	4S-1988
	Blade Terminal	30	5P-4571
	Crimping Tool	1	9S-9150
	Butt Splice	15	136-4877

Batteries and Electrical Parts



Conduits

ITEM	INSIDE DIAMETER		PACKAGE* LENGTH		PART NUMBER
	(in)	(mm)	(ft)	(m)	
Flexible Steel Conduit	0.38	10	25	7.62	5P-3399
Flexible Steel Conduit	0.75	19	10	3.05	5P-6952
Flexible Steel Conduit	1.00	25	10	3.05	5P-6951
Non-Metallic Conduit (Loom / Auto)	0.25	6	100	30.48	5P-5984
Non-Metallic Conduit (Loom / Auto)	0.38	10	50	15.24	5P-5982
Non-Metallic Conduit (Loom / Auto)	0.44	11	25	7.62	5P-5985
Non-Metallic Conduit (Loom / Auto)	0.50	13	50	15.24	5P-5988
Non-Metallic Conduit (Loom / Auto)	0.62	16	25	7.62	5P-5987
Non-Metallic Conduit (Loom / Auto)	0.75	19	25	7.62	5P-5983
Non-Metallic Conduit (Loom / Auto)	1.00	25	10	3.05	5P-5986
Vinyl Covered, Flexible Steel Conduit	0.38	10	25	7.62	5P-0694
Vinyl Covered, Flexible Steel Conduit	0.50	13	50	15.24	5P-0695
Vinyl Covered, Flexible Steel Conduit	0.75	19	10	3.05	5P-0696
Vinyl Covered, Flexible Steel Conduit	1.00	25	10	3.05	5P-1276

* Serviced in increments of their packaged length.



Wire Protector

ITEM	OUTSIDE DIAMETER		PACKAGE* LENGTH		PART NUMBER
	(in)	(mm)	(ft)	(m)	
Wire Protector	0.25	6	25	7.62	5P-6039

* Serviced in increments of their packaged length.

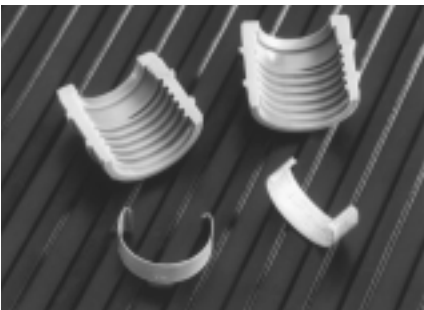

Electrical Conduit Field Repair Fasteners

- Provide fast and easy electrical system repairs.
- Made of high-impact plastic and locked with a steel spring clip.
- Designed to separate for quick installation or removal.

ITEM	PART NUMBER
Repair Fastener	9S-5324



Sure-Seal Electrical Connector Kit

- For use in replacing faulty sure-seal connectors or fabricating new wiring harnesses.
- Provides longer service life and superior corrosion resistance.
- Allows for fast, in-field installation.

KIT PART NUMBER	ITEM	QUANTITY	PART NUMBER
6V-3000	Sure-Seal Electrical Connector Kit		
	Crimping Tool	1	6V-3001
	Box Assembly	1	6V-3007
	Socket	100	7N-7779
	Pin	100	7N-7780
	Sealing Plug	50	9G-3695
	Housing	3	7N-7777
	Housing	3	7N-7778
	Housing	3	7N-9738
	Housing	3	7N-9737
	Housing	3	7N-7781
	Housing	3	7N-7782
	Housing	3	7N-8204
	Housing	3	7N-8205
	Housing	1	9G-3672
	Housing	1	9G-3678
	Housing	1	9G-3671
	Housing	1	9G-3677
	Housing	1	9G-3670
	Housing	1	9G-3676
	Housing	1	9G-3669
	Housing	1	9G-3675
	Housing	1	9G-3668
	Housing	1	9G-3674
	Housing	1	9G-3667
	Housing	1	9G-3673
	Insertion Tool	1	6V-3008

Batteries and Electrical Parts



Deutsch (DT) Style Connector Service Kit

- Required for field repair of Deutsch (DT) style electrical connectors.

KIT PART NUMBER	ITEM	QUANTITY	PART NUMBER
175-3700	Deutsch (DT) Style Connector Service Kit		
	Wedge Removal Tool	1	147-6456
	Removal Tool	6	151-6320
	Utility Box	1	152-7997
	Seal Plug	30	8T-8737
	Connector Pin	30	9X-3401
	Connector Socket	30	9X-3402
	Connector Pin	30	126-1767
	Connector Socket	30	126-1768
	Receptacle Lock Wedge	10	3E-3365
	Receptacle Lock Wedge	10	3E-3371
	Receptacle Lock Wedge	5	3E-3377
	Receptacle Lock Wedge	5	3E-3383
	Receptacle Lock Wedge	5	3E-3389
	Receptacle Lock Wedge	5	3E-5180
	Receptacle Kit	3	102-8801
	Receptacle Kit	10	102-8802
	Receptacle Kit	5	102-8803
	Receptacle Kit	5	102-8804
	Receptacle Kit	3	102-8805
	Receptacle Kit	3	102-8806
	Connector Plug Kit	3	155-2255
	Plug Lock Wedge	5	155-2258
	Plug Lock Wedge	5	155-2259
	Connector Plug Kit	5	155-2260
	Plug Lock Wedge	10	155-2261
	Plug Lock Wedge	5	155-2262
	Plug Lock Wedge	5	155-2263
	Connector Plug Kit	3	155-2265
	Connector Plug Kit	10	155-2270
	Connector Plug Kit	5	155-2271
	Connector Plug Kit	3	155-2274
	Plug Lock Wedge	10	155-2276

Batteries and Electrical Parts



Field Soldering Iron Group

- For use in soldering electrical connections in the field.
- Designed to be lightweight and easy to use.
- Designed with a temperature regulated tip that provides better control for outdoor usage.
- Designed with an in-line fuse to help prevent damage or overload.
- For use with a 12V vehicle cigarette lighter plug or with a 4C-9024 Portable Battery Pack.

ITEM	PART NUMBER
Field Soldering Iron Group	9U-7560
Solder, 0.5 kg. (1 lb.) Spool	9U-7562



Crimping Tools

ITEM	PART NUMBER
Standard Crimping Tool	9S-9150
Heavy-Duty Crimping Tool	8S-1075
12-18 Gauge Crimping Tool	1U-5804



Voltage Tester

- Checks for the presence of up to 36 volts within a circuit.
- Made of a high-impact plastic housing that resists damage from grease or chemicals.

ITEM	PART NUMBER
Voltage Tester	5P-7277

Batteries and Electrical Parts

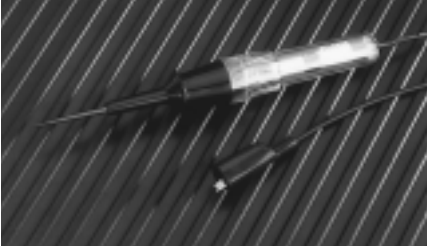

Circuit Tester

- Provides a fast check for continuity in non-energized circuits.
- Shines brightly when connected to zero ohms and progressively dims up to about 10 ohms.
- Includes batteries and bulb.

ITEM	PART NUMBER
Circuit Tester	8T-0500



Spark Plug Firing Indicator

- Provides a simple, effective way to check spark plug voltage.
- Shows voltage intensity, spark plug misfires, faulty coils, and faulty wiring.
- Features a compact size and handy clip for pocket storage.

ITEM	PART NUMBER
Firing Indicators	9U-6695



Continuity Tester/Flashlight

- Made of high impact plastic in a Cat yellow and black design.
- For use as a flashlight or continuity tester.

ITEM	PART NUMBER
Continuity Tester/Flashlight	1U-7318

CHEMICALS, COMPOUNDS, AND PAINT

Adhesives	46
Sealants	47
Cleaners	52
Dyes	53
Oils	54
Ether	55
Compounds	56
Paint / Thinner	57

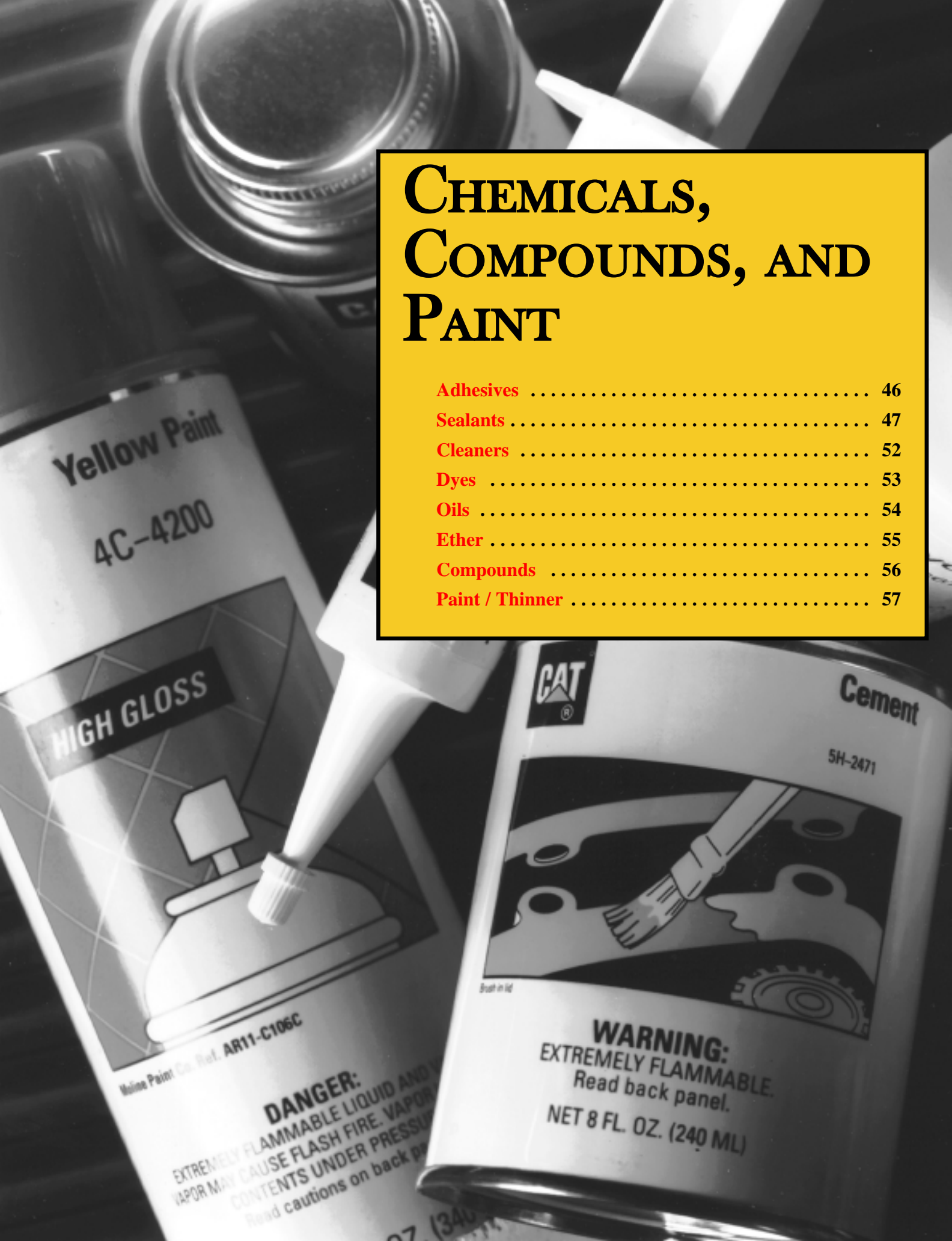

Chemicals, Compounds, and Paint



Cement

- Makes a very strong flexible bond.
- Contact cement, in easy to use brush top can.
- Makes a tacky, pliable bond using pressure-sensitive rubber contact cement.
- For use in bonding cork, leather, rubber and metals.
- For use in working temperatures that do not exceed 225° F (107° C).
- Note: Flammable material — use with care.

ITEM	SIZE		PART NUMBER
	(fl oz.)	(ml)	
Cement	8.00	236	5H-2471



Spray Adhesive

- For use in applying items such as headliners, decals, and insignias.
- Similar to 5H-2471 (contact cement).
- Aerosol can for faster coverage of large areas.

ITEM	SIZE		PART NUMBER
	(oz.)	(g)	
Spray Adhesive	11.00	311	154-1287



Depend No-Mix Adhesive

- Bonds almost any substrate in minutes.
- Fast curing for handling strength in just two minutes.
- Features high peel and impact strength.
- Heat resistant to 250° F (121° C) and oil resistant.
- For use with wood, ceramic, glass, metal, cork, chrome, and many more substrates.
- Kit contains a 0.85 fl. oz. (25 ml) container of adhesive and a 1.20 fl. oz. (35 ml) container of activator.

ITEM	PART NUMBER
Depend No-Mix Adhesive Kit	154-8874

Chemicals, Compounds, and Paint



Fuel Tank Repair

- Fills and seals holes and seam leaks for temporary “in-field” repairs.
- Adheres to “fuel-wetted” surfaces.
- Cures in four hours.

ITEM	SIZE		PART NUMBER
	(oz.)	(g)	
Fuel Tank Repair	0.25	7	8T-9019
Fuel Tank Repair Kit for Plastic Tanks			1U-8118



Radiator Repair

- Seals holes and seam leaks for normal operating pressures.
- Cures in just 15 minutes for temporary radiator repairs.

ITEM	SIZE		PART NUMBER
	(oz.)	(g)	
Radiator Repair	0.50	14	8T-9018

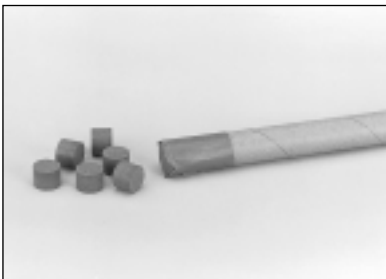

Sealant For Liquid Filled Rims On Wheel Loaders

- Seals cracks and pinholes in rims.
- Also for use when installing a new liquid filled rim.
- Use one tube per rim.

ITEM	PART NUMBER
Sealant for Liquid Filled Rims on Wheel Loaders	2G-7781

Chemicals, Compounds, and Paint



Form-A-Gasket Sealant - #1, #2, #3

- #1 — Fast-drying and hard setting; resists gasoline, kerosene, fuel and diesel oils, anti-freeze, alkalis, and steam. Withstands pressures to 5000 psi (34,475 kPa) and temperatures to 400° F (204° C).
- #2 — Slow-drying, dries to a pliable film; seals T-joints and segmented gasket joints. Withstands pressures to 5000 psi (34,475 kPa) and temperatures to 400° F (204° C).
- #3 — Thin and brushable for finely machined surfaces. Dries slowly, non-hardening, and resists most shop fluids.

ITEM	SIZE		SIZE		PART NUMBER
	(fl oz.)	(ml)	(oz.)	(g)	
Form-A-Gasket #1			3.00	85	4C-9501
Form-A-Gasket #2			3.00	85	4C-9502
Form-A-Gasket #3	4.00	120			4C-9505



Liquid Gasket

- Replaces gaskets up to .003” (0.08 mm) where temperatures do not exceed 300° F (149° C).
- Available in both 50 ml. (1.69 fl. oz.) tube and 8 fl. oz. brush top can.
- Either contains chlorine and both are highly flammable.

ITEM	SIZE		PART NUMBER
	(fl oz.)	(ml)	
Liquid Gasket (can)	8.00	236	138-8436
Liquid Gasket (tube)	1.69	50	9U-5839



Gasket Maker

- Replaces gaskets up to .01” (0.25 mm) where temperatures do not exceed 350° F (177° C).
- Seals up to .01” (0.25 mm) on aluminum, iron, and steel joints.
- Eliminates bolt loosening caused by relaxation of sheet-type gaskets.

ITEM	SIZE		SIZE		PART NUMBER
	(fl oz.)	(ml)	(oz.)	(g)	
Gasket Maker	1.69	50			6V-6640
Gasket Maker Flexible			10.50	300	4C-5300
Gasket Maker Flexible	1.69	50			1U-8846

Chemicals, Compounds, and Paint



RTV Silicone (Red) High Temperature Sealant

- For bonding, sealing, and gasketing applications that require maximum heat resistance, 500° F (206° C) constant, intermittently up to 600° F (316° C).
- Resists cracking, shrinking, and migrating caused by thermal cycling.

ITEM	SIZE		PART NUMBER
	(fl oz.)	(ml)	
RTV Silicone-Red	3.00	83	4C-9614
RTV Silicone-Red	10.15	300	8T-9013



RTV Silicone (Clear) General Purpose Sealant

- For bonding, sealing, or gasketing jobs that have a 400° F (204° C) constant temperature, 500° F (260° C) intermittent.
- Dries clear and flexible for jobs requiring a clear cosmetic appearance — such as glass, lights, and electrical wiring.

ITEM	SIZE		PART NUMBER
	(fl oz.)	(ml)	
RTV Silicone-Clear	3.00	83	4C-9613
RTV Silicone-Clear	10.15	300	8T-9014



RTV Silicone (Blue) General Purpose Sealant

- Sensor safe.
- For gasketing jobs that have a constant temperature up to 400° F (204° C), 500° F (260° C) intermittent.
- Provides low odor, non-corrosive, low volatility sealing for salvage work and low pressure flange surfaces — such as oil pans, gear covers, valve covers, and transmission covers.
- Available in a pressurized container for easier dispensing.

ITEM	SIZE		PART NUMBER
	(fl oz.)	(ml)	
RTV Silicone-Blue (Pressurized)	8.75	258	141-5831
RTV Silicone-Blue	10.15	300	8T-9022

Chemicals, Compounds, and Paint



RTV Silicone (Black) General Purpose Sealant

- For general purpose bonding, sealing, or gasketing jobs that have a maximum constant temperature of 400° F (240° C), 500° F (260° C) intermittent.
- Available in a pressurized container for easier dispensing.

ITEM	SIZE		PART NUMBER
	(fl oz.)	(ml)	
RTV Silicone-Black	3.00	83	3S-6252
RTV Silicone-Black (Pressurized)	7.25	214	141-5830



RTV Silicone, Sensor Safe, Non-Corrosive General Purpose Sealant

- For general purpose bonding, sealing, or gasketing jobs that have a maximum temperature of 400° F (240° C).
- Available in a non-corrosive form for sealing around electronic components.

ITEM	SIZE		PART NUMBER
	(fl oz.)	(ml)	
RTV Silicone-Black	3.00	83	4C-9612
RTV Silicone-White (Non-Corrosive)	3.00	83	8T-0065



Fast Cure Epoxy Mixercup Kit

- High strength adhesive for general purpose bonding, sealing, and patching.
- Contains ten mixercups of premeasured resin and hardener.

ITEM	SIZE		PART NUMBER
	(oz.)	(g)	
Fast Cure Epoxy Mixercups	1.50	43	5P-3321

Chemicals, Compounds, and Paint



Manifold Sealant

- For sealing and bonding of male/female segmented exhaust manifold joints that have a maximum temperature of 2000° F (1093° C).

ITEM	SIZE		PART NUMBER
	(fl oz.)	(ml)	
Caterpillar Manifold Sealant	16.00	473	2P-2333



High Strength Thread Lock

- For securing parts that withstand heavy shock, vibration, or extreme chemical and environmental conditions.

ITEM	SIZE		PART NUMBER
	(fl oz.)	(ml)	
High Strength Thread Lock	0.34	10	154-9731
High Strength Thread Lock	1.69	50	155-0695



Sealant Repair Kit

- Keeps all the sealant repair items in a durable, shock resistant, polyethylene case.

KIT PART NUMBER	ITEM	SIZE		PART NUMBER
		(fl oz.)	(ml)	
9S-3262	Sealant Repair Kit			
	Retaining Compound	1.67	50	4C-9507
	Bearing Mount	1.67	50	7M-7456
	Thread Lock	1.67	50	9S-3263
	Pipe Sealant	1.67	50	5P-3413
	Quick Cure Primer	4.00	120	4C-9500



Penetrating Oil

- Heavy-duty penetrating oil.

ITEM	SIZE		SIZE		PART NUMBER
	(fl oz.)	(ml)	(oz.)	(g)	
Penetrating Oil			13.00	368	1U-8265
Penetrating Oil	1.00	30			1U-5499

Chemicals, Compounds, and Paint



Battery Saver and Cleaner

- Cleans and prevents corrosion on battery terminals and cable ends.

ITEM	SIZE		PART NUMBER
	(oz.)	(g)	
Battery Saver and Cleaner	13.00	368	1U-8267



Component Cleaner

- Cleans and degreases with a short drying time and no residue.
- Non-flammable.
- Contains percholoroethylene

ITEM	SIZE		PART NUMBER
	(oz.)	(g)	
Component Cleaner	13.00	368	138-8440



Brake Cleaner

- Cleans and dries critical parts quickly with no residue.
- Flammable.
- Non-chlorinated formula.

ITEM	SIZE		PART NUMBER
	(oz.)	(g)	
Brake Cleaner	16.00	453	138-8441



Glass Cleaner

- Cleans glass with an anti-static formula that keeps dust from clinging to surfaces.

ITEM	SIZE		PART NUMBER
	(oz.)	(g)	
Glass Cleaner	15.00	425	138-8445

Chemicals, Compounds, and Paint



Mineral Spirits

- General purpose solvent that dries with a light oily film.

ITEM	SIZE		PART NUMBER
	(oz.)	(g)	
Mineral Spirits	12.00	340	138-8437



Rust Preventative

- Produces a light rust preventative film to prevent flash rusting.

ITEM	SIZE		PART NUMBER
	(oz.)	(g)	
Rust Preventative	12.00	340	138-8447



Dyes for Liquids

- Adds color to lubricating oils, transmission oils, hydraulic oils, fuels and coolants.
- Highly concentrated for high visibility at low concentrations.
- Available in ultraviolet sensitive colors for ultraviolet light visibility in dark colored oils.
- For use in color coding oils for clear identification.
- For use in identifying leaks when more than one source is possible.

ITEM	SIZE		PART NUMBER
	(fl oz.)	(ml)	
Red Dye	8.00	236	9U-5031
Blue Dye	8.00	236	5U-5032
Oil Glo (Ultraviolet Sensitive)	1.00	30	1U-5572
Oil Glo (Ultraviolet Sensitive)	16.00	474	1U-5573
Gas Glo (Ultraviolet Sensitive)	1.00	30	1U-5574
Gas Glo (Ultraviolet Sensitive)	16.00	474	1U-5575
Water Glo (Ultraviolet Sensitive)	1.00	30	1U-5576
Water Glo (Ultraviolet Sensitive)	16.00	474	1U-5577

Chemicals, Compounds, and Paint



Toolmaker's Ink/Layout Blue

- Checks the fits between engine valves and valve seats.
- Contains a deep blue color that makes scribed lines stand out.
- For use in checking fit on fuel injectors/sleeves.
- For use for sheet metal layout when allowed to dry.

ITEM	SIZE		SIZE		PART NUMBER
	(fl oz.)	(ml)	(oz.)	(g)	
Toolmaker's Layout Blue			12.00	340	9U-6075 (12)
Toolmaker's Layout Blue	7.50	222			9U-6076 (12)

Available only for U.S. and U.S. export.



V.C.I. Oil

- Protects all ferrous parts when maintained at the proper concentration in a closed container.
- Has a vapor phase that is more strongly attracted to bare ferrous metals than water.
- Performs indefinitely as long as it stays sealed in the compartment.
- Meets Mil-P-46002A.
- For use in storing vehicles and vehicle compounds such as engines and engine transmissions for up to 1 year.
- For use at a rate of 3 oz. per 1000 cu. in. (5.5 ml per liter) of volume.

ITEM	SIZE		PART NUMBER
	(gal)	(L)	
V.C.I. Oil	0.250	0.95	4C-6792
V.C.I. Oil	1.000	3.79	4C-6793
V.C.I. Oil	5.000	18.93	4C-6794

Chemicals, Compounds, and Paint



Ether Starting Cylinder

- Helps ensure cold weather starts.
- Injects ether into the air intake, increasing engine combustion.
- Provides up to 315 shots, depending on valve size.
- Note: Flammable material — use with care.

ITEM	DIAMETER		SIZE		PART NUMBER
	(in)	(mm)	(oz.)	(g)	
Ether Starting Cylinder (Small diameter)	3.00	76	18.00	509	7N-0296
Ether Starting Cylinder (Large diameter)	4.00	100	21.00	594	7X-1062
Ether Starting Cylinder (Large diameter)			8.00	227	130-8414



O-Ring Compound

- Retains o-rings for vertical or overhead assembly.
- Not for use on air conditioning systems.

ITEM	SIZE		SIZE		PART NUMBER
	(fl oz.)	(ml)	(gal)	(L)	
O-Ring Compound			1.000	3.79	1U-6395
O-Ring Compound	8.00	236			1U-6396



Thread Lubricant

- Helps prevent galling and thread seizure to components such as connecting rods and undercarriage bolts in moderate temperature applications.
- For use during torque turn tightening and in oil compartments where oil is analyzed by S-O-S.

ITEM	SIZE		PART NUMBER
	(fl oz.)	(ml)	
Thread Lubricant	4.00	118	4C-5591
Thread Lubricant	8.00	236	4C-5592
Thread Lubricant	32.00	950	4C-5593

Chemicals, Compounds, and Paint



High Temperature Anti-Seize Compound

- Helps prevent thread seizure to components in high temperature applications.
- For applications that have a maximum temperature of 1800° F (982° C).

ITEM	SIZE		PART NUMBER
	(fl oz.)	(ml)	
High Temperature Anti-Seize Compound (aerosol)	12.5	354	154-1288
High Temperature Anti-Seize Compound	4.00	118	4C-5598
High Temperature Anti-Seize Compound	8.00	236	4C-5599
High Temperature Anti-Seize Compound	32.00	950	5P-3931



Heat Sink Compound

- Protects semi-conductors, power transistors, diodes, and SCR's carrying high current.

ITEM	SIZE		PART NUMBER
	(fl oz.)	(ml)	
Heat Sink Compound	4.00	118	5P-8937
Heat Sink Compound	14.00	414	5P-9210

Paint



High Gloss

- Produces a finish that sets up in minutes, is tack-free in a few hours, and dries overnight to a hard, glossy film that is very resistant to fading, chalking, cracking, and chipping.
- For interior or exterior use on earthmoving, construction and material handling equipment, trucks, engines, machinery, and metal buildings.
- For use without a primer when applied to wood or metal.



Medium Gloss

- Produces a finish that sets up in minutes, is tack-free in a few hours, and dries overnight to a hard, scuff-resistant finish.
- For use on equipment requiring outside durability.
- For use without a primer when applied to wood or metal.



Black Muffler Paint

- Prevents rust and is resistant to sunlight and extreme temperature changes.
- For use with temperatures up to 1000° F.
- For use on mufflers, exhaust stacks, and boiler fronts.

Chemicals, Compounds, and Paint

Paint



Urethane Paint

- Provides excellent adhesion to urethane and conventional paints.
- Produces a finish that sets up in minutes, is tack-free in a few hours, and dries overnight to a hard, high-gloss finish.
- Requires hardener.
- For use in repairing and touching up urethane finishes.



Miscellaneous Aerosol Products

- Available in many different colors and finishes.

Paint



Yellow Primer

- Provides excellent adhesion and durability.
- Dries tack-free in a few hours and overnight to a hard, durable coating with excellent weather resistance.



Paint and Primer Thinner/Retarder

- Provides flow and levelling in hot conditions, dry conditions, and on large equipment where slower drying is desired.
- Minimizes risk of over-thinning due to its high solvency.
- Evaporates slowly and is less likely to cause dry overspray.
- For use with any type of coating, except lacquer.



Paint and Primer Thinner

- Will not impair the setting-up or tack-free time of even the fastest drying synthetic enamel or primer.
- Minimizes risk of over-thinning due to its high solvency.
- Evaporates fast and is less likely to cause sagging or running.
- For use with any type of coating, except lacquer.

Chemicals, Compounds, and Paint

Paint

ITEM	SIZE		SIZE		PART NUMBER	MPM REFERENCE NUMBER
	(oz.)	(g)	(gal)	(L)		
High Gloss						
Caterpillar Yellow	12.00	340			4C-4200 (12)	AR11-C106C
Caterpillar Yellow			1.000	3.79	4C-6129 (4)	AR11-C106C
Caterpillar Yellow			5.000	18.95	4C-6122	5R11-C106C
Caterpillar Yellow			55.000	208.45	4C-6127	DS11-C106C
Caterpillar Yellow Fast Dry			1.000	3.79	4C-4184 (4)	1R11-C106A
Caterpillar Yellow Fast Dry			5.000	18.95	4C-4192	5R11-C106A
Caterpillar Yellow Fast Dry			55.000	208.45	4C-4207	DS11-C106A
Caterpillar Yellow Water Reducible			1.000	3.79	9U-7725	1R12-C108A
Caterpillar Yellow Water Reducible			5.000	18.95	9U-7726	5R12-C108A
Caterpillar Hiway Yellow	12.00	340			4C-4201 (12)	AR11-C107A
Caterpillar Hiway Yellow			1.000	3.79	4C-4185 (4)	1R11-C107A
Caterpillar Hiway Yellow			5.000	18.95	4C-4193	5R11-C107A
Caterpillar White	12.00	340			4C-4203 (12)	AR11-W143A
Caterpillar White			1.000	3.79	4C-4187 (4)	1R11-W143A
Caterpillar White			5.000	18.95	4C-4194	5R11-W143A
Caterpillar White			55.000	208.45	4C-4209	DS11-W143A
Barber-Greene Green			1.000	3.79	9U-7951 (4)	1R11-G224A
Medium Gloss						
Caterpillar Black	12.00	340			4C-4198 (12)	AR11-B121A
Caterpillar Black			1.000	3.79	4C-4183 (4)	1R11-B121A
Caterpillar Black			5.000	18.95	4C-4191	5R11-B121A
Caterpillar Black			55.000	208.45	4C-4206	DS11-B121A
Caterpillar Mojave Brown	12.00	340			4C-4202 (12)	AR11-N130A
Caterpillar Mojave Brown			1.000	3.79	4C-4186 (4)	1R11-N130A
Dawn Gray			1.000	3.79	9U-7949 (4)	1R11-F377A
Black Muffler Paint						
Black Muffler Paint	12.00	340			4C-4199 (12)	AR11-B122A
Urethane Paint						
Caterpillar Yellow Touch-Up for Urethane			1.000	3.79	4C-6134 (4)	1R13-C109A
Caterpillar Yellow Touch-Up for Urethane			5.000	18.95	4C-6126	5R13-C109A
Caterpillar Black Touch-Up for Urethane			1.000	3.79	4C-6133 (4)	1R13-B125A
Miscellaneous Aerosol Products						
Flat Black	12.00	340			4C-5842 (6)	AR11-B725A
Gloss Black	12.00	340			4C-5843 (6)	AR11-B770A
Bright Red	12.00	340			4C-5844 (6)	AR11-D810A
Blue (OSHA)	12.00	340			4C-5845 (6)	AR11-E510A
Green	12.00	340			4C-5848 (8)	AR11-F325A
Chrome Aluminum	12.00	340			4C-5849 (9)	AR11-0211A
Orange	12.00	340			4C-5847 (7)	AR11-G485A
Machine Dark Gray	12.00	340			4C-5846 (6)	AR11-K760A

Number in parentheses () after the part number indicates the quantity per package.

Chemicals, Compounds, and Paint

Paint

ITEM	SIZE		SIZE		PART NUMBER	MPM REFERENCE NUMBER
	(oz.)	(g)	(gal)	(L)		
Miscellaneous Aerosol Products (cont.)						
Yellow Urethane Touch-Up	12.00	340			4C-9817 (6)	AR13-C109A
Black Urethane Touch up	12.00	340			4C-9816 (6)	AR13-B125A
High Gloss Barber-Greene Green	12.00	340			9U-7950 (6)	AR11-G224A
Dawn Gray	12.00	340			9U-7948 (6)	AR11-F377A
Yellow Primer						
Yellow Primer	12.00	340			4C-4205 (12)	AR21-N116A
Yellow Primer			1.000	3.79	4C-4190 (4)	1R21-N116A
Yellow Primer			5.000	18.95	4C-4197	5R21-N116A
Yellow Primer			55.000	208.45	4C-4211	DS21-N116A
Paint and Primer Thinner/Retarder						
Paint and Primer Thinner/Retarder			1.000	3.79	4C-6130 (6)	1R11-X121A
Paint and Primer Thinner/Retarder			5.000	18.95	4C-6123	5R11-X121A
Paint and Primer Thinner/Retarder			55.000	208.45	4C-6135	DS11-X121A
Paint and Primer Thinner						
Paint and Primer Thinner			1.000	3.79	4C-4189 (6)	1R11-X118A
Paint and Primer Thinner			5.000	18.95	4C-4196	5R11-X118A
Paint and Primer Thinner			55.000	208.45	4C-4210	DS11-X118A

Number in parentheses () after the part number indicates the quantity per package.

COOLING SYSTEMS

Coolants	64
Coolant Accessories	67
Infrared Thermometer	67
Water Temperature Thermostat	68



Cooling Systems



Extended Life Coolant (ELC™)

- Increases coolant life from 3000 to 6000 hours over conventional coolant.
- Does not require liquid or spin-on Supplemental Coolant Additives (SCA) or coolant conditioners.
- Costs from 40-60% less than conventional coolant over the life of the coolant.
- Improves water pump seal life.
- Does not form silica gel.
- Does not form hard water scale.
- Requires less disposal volume.
- Contains no silicates, phosphates, nitrates, or borates.
- Exceeds Cat EC-1 coolant performance requirement.
- Meets the performance requirements of ASTM D 4985 and ASTM D 5345 for heavy duty low silicate antifreeze/coolants, and ASTM D 3306 and ASTM D 4656 for automotive applications.
- Used as standard factory fill coolant and is the preferred coolant for Caterpillar machines and engines.
- For use in diesel, gasoline, and natural gas engines — including aluminum based cooling systems.

ITEM	SIZE		PART NUMBER
	(gal)	(L)	
Extended Life Coolant (ELC™) - 50/50 Pre-Mix	1		101-2844
	5		129-2151
	55		101-2845
	Bulk		156-2653
Extended Life Coolant (ELC™) - Concentrate	1		119-5150
Extended Life Coolant (ELC™) - Extender*	0.250 (1 qt)		119-5152
	1		210-0786

* Must be added once to the cooling systems at either 3000 hours for machines or 300,000 miles for on-highway truck engines.



Diesel Engine Antifreeze/Coolant (DEAC™)

- Helps prevent corrosion and pitting in the cylinder liner and block.
- Contains conventional coolant technology with low silicate formulation.
- Fully formulated not to require initial dose of Supplemental Coolant Additive (SCA) at fill-up.
- Requires addition of Supplemental Coolant Additives (SCA) or coolant conditioners every 250 hours.
- For use in Cat diesel, gasoline, and natural gas engine cooling systems.

ITEM	SIZE		PART NUMBER
	(gal)	(L)	
Diesel Engine Antifreeze/Coolant (DEAC™) - Concentrate	1		8C-3684
	55		8C-3686
	Bulk		156-2649
		4	9X-6586
		20	9X-6585
		205	9X-6584



Supplemental Coolant Additives (SCA)

- Helps stop rust and mineral deposits from forming in the cooling system.
- Protects all metals.
- Protects against cylinder liner cavitation and corrosion.
- Will not affect gaskets or hoses.
- For use with Cat DEAC or other low silicate Heavy Duty Diesel Engine Coolants — including glycol-based antifreezes.

ITEM	SIZE		PART NUMBER
	(gal)	(L)	
Supplemental Coolant Additive (SCA)	0.063 (1/2 pt)		6V-3542
	0.094 (3/4 pt)		111-2372
	0.125 (1 pt)		8T-1589
	0.250 (1 qt)		3P-2044
	5		8C-3680
	55		5P-2907

Cooling Systems



Cooling System Cleaner - Standard Type

- Removes scale or lime deposits.
- Cleans cooling system while the machine works.
- Requires several weeks in the cooling system for full effect.
- Not for use in removing large amounts of oil from cooling systems.

ITEM	SIZE		PART NUMBER
	(gal)	(L)	
Cooling System Cleaner - Standard Type	0.500 (2 qt)		6V-4511



Cooling System Cleaner - Quick Flush

- Allows for one-step cleaning in just 90 minutes.
- Removes lime, scale, and solder bloom.
- For use as preventive maintenance or as a short-time flush at the time of coolant change.
- Not for use in removing large amounts of oil from cooling systems.

ITEM	SIZE		PART NUMBER
	(gal)	(L)	
Cooling System Cleaner - Quick Flush	0.125 (1 pt)		4C-4609
	0.250 (1 qt)		4C-4610
	1		4C-4611
	5		4C-4612
	55		4C-4613



Coolant and Battery Tester

- For use in testing both coolant freezing point and battery fluid condition.
- For use with hot and cold radiators.
- For use in testing some types of permanent antifreeze, such as DOWtherm 209.

ITEM	PART NUMBER
Coolant and Battery Tester - Fahrenheit	1U-7297
Coolant and Battery Tester - Celsius	1U-7298



Coolant Conditioner Test Kit

- Requires a simple dip test which takes only minutes to perform.
- Does not require dilution, titration, or drops to count.
- Includes a color density change for people with color blindness.

ITEM	PART NUMBER
Coolant Conditioner Test Kit (100 Test Strips)	4C-9301
Refill Test Strips (50)	4C-9297



Infrared Thermometer

- Small, light-weight design that is extremely portable.
- Requires no preadjustment — just pull the trigger and read the temperature.
- Reduces diagnostic time for any temperature-related job.
- Records temperatures from -25°F to 1600°F (-30°C to 870°C).
- Allows user to switch from Fahrenheit to Celsius scales.

ITEM	PART NUMBER
Infrared Thermometer (Standard, Battery Power)	164-3310
Infrared Thermometer (Enhanced, 110 VAC or Battery)	164-3320
Infrared Thermometer (Enhanced, 220 VAC or Battery)	166-9030

Cooling Systems



Water Temperature Thermostat

- Eliminates over 95% of normal leaking during initial opening phase.
- Provides precise control of engine temperature.
- For use on all Cat engines.

MODEL	SERIAL NUMBER	PART NUMBER
D342	49B109-UP	6I-4954 (2)
D346	98N435-UP	4W-4794 (4)
D353	46B7926-UP	6N-4540 (2)
1693	65B1-UP	6I-4954 (2)
3054	4ZK1-UP, 5HK1-UP, 6FK1-UP	4W-8063
3056	1ML1-UP, 7AK1-UP	4W-8063
3114	5EF1-UP	126-5869*
3116	2WG1-UP	126-5869*
	7SF2351-UP	102-8392
3176	ZY91-UP	7C-3095
3204	45V1-UP	4P-6616
3208	32Y1-UP, 90N37285-UP	102-8392 (2)
	2ZI-UP	102-8392
3304	10E2863-UP	111-8010
3306	64Z517-UP	111-8010
	63Z16872-UP	7C-3095
	76R6532-UP	7C-3095
3406	6TB1-UP, 75B1-UP	4W-4794
	4MG26525-UP	7C-3095
	8TC4481-UP	7C-3095
3408	67U1-UP	4W-4794 (2)
	28V1-UP	4W-4794 (2)
3412	38S1-UP	4W-4794 (2)
3508	95Y1-UP, 97Y1-UP	4W-4794 (4)
3512	49Y1-UP, 51Y1-UP	4W-4794 (4)
3516	27Z1-UP, 28Z1-UP	4W-4794 (4)

Number in parentheses () after the part number indicates the quantity required.

* Requires a 126-5870 gasket.



FILTERS

Filters By Machine Model	70
Ultra High Efficiency Radial Seal Filters	207
Air Filter Service Indicators	207
High Efficiency Hydraulic Cartridge Filters	208
High Efficiency Hydraulic Spin-on Filters	209
Filter Cutting Tool	209

Filters - Articulated Trucks

FILTER TYPE	PART NUMBER	HIGH EFFICIENCY	FIRE RESISTANT
ARTICULATED TRUCKS ^a			
725 Articulated Truck			AFX1-UP
Engine Oil	1R-0716		
Fuel Primary	133-5673		
Fuel Secondary	1R-0762		
Hydraulic	1R-0741	132-8876	4T-3132
Power Train	139-1537		
Power Train	144-6691	126-1815	121-9868
Air Primary	142-1339		
Air Secondary	142-1404		
730 Articulated Truck			AGF1-UP
Engine Oil	1R-0716		
Fuel Primary	133-5673		
Fuel Secondary	1R-0762		
Hydraulic	1R-0741	132-8876	4T-3132
Power Train	139-1537		
Power Train	144-6691	126-1815	121-9868
Air Primary	142-1339		
Air Secondary	142-1404		
735 Articulated Truck			AWR1-UP
Engine Oil	1R-0716		
Fuel Primary	133-5673		
Fuel Secondary	1R-0749		
Hydraulic	132-8876		
Power Train	139-1537		
Air Primary	142-1340		
Air Secondary	142-1403		
740 Articulated Truck			AXM1-UP
Engine Oil	1R-0716		
Fuel Primary	133-5673		
Fuel Secondary	1R-0749		
Hydraulic	132-8876		
Power Train	144-6691	126-1815	121-9868
Power Train	1R-0719	132-8875	4T-3131
Power Train	4T-3131		
Air Primary	142-1340		
Air Secondary	142-1403		
740 Articulated Truck			AZZ1-UP
Engine Oil	1R-0716		
Fuel Primary	133-5673		
Fuel Secondary	1R-0749		
Hydraulic	132-8876		
Power Train	144-6691	126-1815	121-9868
Power Train	1R-0719	132-8875	4T-3131
Air Primary	142-1340		
Air Secondary	142-1403		

FILTER TYPE	PART NUMBER	HIGH EFFICIENCY	FIRE RESISTANT
AD45 Articulated Truck			BKZ181-UP
Engine Oil	1R-0716		
Fuel Primary	129-0373		
Fuel Secondary	1R-0749		
Power Train	1R-0719	132-8875	4T-3131
Power Train	1R-0741	132-8876	4T-3132
Air Primary	4W-5228		
Air Secondary	1N-4864		
AD55 Articulated Truck			ANW1-UP
Engine Oil	1R-0716		
Fuel Primary	129-0373		
Fuel	170-0061		
Fuel Secondary	1R-0749		
Hydraulic	130-3212	126-1814	
Hydraulic	9T-0973	126-1817	134-3014
Power Train	108-1153	126-1817	134-3014
Power Train	1G-8878	102-2828	156-0214
Power Train	9T-0973	126-1817	134-3014
Air Primary	4W-5228		
Air Secondary	1N-4864		
AE40 Articulated Truck			1ZZ1-UP
Engine Oil	1R-0716		
Fuel Primary	129-0373		
Fuel Secondary	1R-0749		
Power Train	1R-0719	132-8875	4T-3131
Power Train	1R-0741	132-8876	4T-3132
Power Train	9M-2342		
Air Primary	4W-5228		
Air Secondary	1N-4864		
AE40 Series II Articulated Truck			BLW181-UP
Engine Oil	1R-0716		
Fuel Primary	129-0373		
Fuel	170-0061		
Fuel Secondary	1R-0749		
Power Train	1R-0719	132-8875	4T-3131
Power Train	1R-0741	132-8876	4T-3132
Air Primary	4W-5228		
Air Secondary	1N-4864		
D20D Articulated Truck			6NG1-UP
Engine Oil	1R-0739		
Fuel Primary	9M-2341		
Fuel Secondary	1R-0751		
Power Train	1R-0719	132-8875	4T-3131
Power Train	1R-0741	132-8876	4T-3132
Air Primary	7W-5316		
Air Secondary	2S-1287		

a - For quantities, refer to parts book.

Filters - Articulated Trucks

FILTER TYPE	PART NUMBER	HIGH EFFICIENCY	FIRE RESISTANT
D20D Articulated Truck			9MG1-UP
Engine Oil	1R-0739		
Fuel Primary	9M-2341		
Fuel Secondary	1R-0751		
Power Train	1R-0719	132-8875	4T-3131
Power Train	1R-0741	132-8876	4T-3132
Air Primary	7W-5316		
Air Secondary	2S-1287		
D25C Articulated Truck			9YC1-1011
Engine Oil	1R-0739		
Fuel Primary	9M-2341		
Fuel Secondary	1R-0750		
Hydraulic	1R-0741	132-8876	4T-3132
Power Train	1R-0719	132-8875	4T-3131
Air Primary	7W-5495		
Air Secondary	1P-7360		
D25D Articulated Truck			1HK674-UP
Engine Oil	1R-0739		
Fuel Primary	9M-2341		
Fuel Secondary	1R-0750		
Hydraulic	1R-0741	132-8876	4T-3132
Power Train	1R-0719	132-8875	4T-3131
Air Primary	6I-0273		
Air Secondary	6I-0274		
D25D Articulated Truck			3AJ415-UP
Engine Oil	1R-0739		
Fuel Primary	9M-2341		
Fuel Secondary	1R-0750		
Hydraulic	1R-0741	132-8876	4T-3132
Power Train	1R-0719	132-8875	4T-3131
Air Primary	6I-0273		
Air Secondary	6I-0274		
D25D Articulated Truck			1HK1-673
Engine Oil	1R-0739		
Fuel Primary	9M-2341		
Fuel Secondary	1R-0750		
Hydraulic	1R-0741	132-8876	4T-3132
Power Train	1R-0719	132-8875	4T-3131
Air Primary	6I-0273		
Air Primary	7W-5495		
Air Secondary	1P-7360		
Air Secondary	6I-0274		
D25D Articulated Truck			3AJ1-414
Engine Oil	1R-0739		
Fuel Primary	9M-2341		
Fuel Secondary	1R-0750		
Hydraulic	1R-0741	132-8876	4T-3132
Power Train	1R-0719	132-8875	4T-3131

FILTER TYPE	PART NUMBER	HIGH EFFICIENCY	FIRE RESISTANT
D25D Articulated Truck (cont.)			3AJ1-414
Air Primary	6I-0273		
Air Primary	7W-5495		
Air Secondary	1P-7360		
Air Secondary	6I-0274		
D25D Articulated Truck			9RF1-UP
Engine Oil	1R-0739		
Fuel Primary	9M-2341		
Fuel Secondary	1R-0750		
Hydraulic	1R-0741	132-8876	4T-3132
Power Train	1R-0719	132-8875	4T-3131
Air Primary	6I-0273		
Air Primary	7W-5495		
Air Secondary	1P-7360		
Air Secondary	6I-0274		
D30C Articulated Truck			7ZC1-257
Engine Oil	1R-0739		
Fuel Primary	9M-2341		
Fuel Secondary	1R-0750		
Hydraulic	1R-0741	132-8876	4T-3132
Power Train	1R-0719	132-8875	4T-3131
Air Primary	7W-5495		
Air Secondary	1P-7360		
D30D Articulated Truck			1HK674-UP
Engine Oil	1R-0739		
Fuel Primary	9M-2341		
Fuel Secondary	1R-0750		
Hydraulic	1R-0741	132-8876	4T-3132
Power Train	1R-0719	132-8875	4T-3131
Air Primary	6I-0273		
Air Secondary	6I-0274		
D30D Articulated Truck			1HK1-673
Engine Oil	1R-0739		
Fuel Primary	9M-2341		
Fuel Secondary	1R-0750		
Hydraulic	1R-0741	132-8876	4T-3132
Power Train	1R-0719	132-8875	4T-3131
Air Primary	6I-0273		
Air Primary	7W-5495		
Air Secondary	1P-7360		
Air Secondary	6I-0274		
D30D Articulated Truck			3AJ1-414
Engine Oil	1R-0739		
Fuel Primary	9M-2341		
Fuel Secondary	1R-0750		
Hydraulic	1R-0741	132-8876	4T-3132
Power Train	1R-0719	132-8875	4T-3131
Air Primary	6I-0273		

a - For quantities, refer to parts book.

Filters - Articulated Trucks

FILTER TYPE	PART NUMBER	HIGH EFFICIENCY	FIRE RESISTANT
D30D Articulated Truck (cont.)			3AJ1-414
Air Primary	7W-5495		
Air Secondary	1P-7360		
Air Secondary	6I-0274		
D30D Articulated Truck			3AJ415-UP
Engine Oil	1R-0739		
Fuel Primary	9M-2341		
Fuel Secondary	1R-0750		
Hydraulic	1R-0741	132-8876	4T-3132
Power Train	1R-0719	132-8875	4T-3131
Air Primary	6I-0273		
Air Secondary	6I-0274		
D30D Articulated Truck			9RF1-UP
Engine Oil	1R-0739		
Fuel Primary	9M-2341		
Fuel Secondary	1R-0750		
Hydraulic	1R-0741	132-8876	4T-3132
Power Train	1R-0719	132-8875	4T-3131
Air Primary	6I-0273		
Air Primary	7W-5495		
Air Secondary	1P-7360		
Air Secondary	6I-0274		
D35C Articulated Truck			2GD1-124
Engine Oil	1R-0739		
Fuel Primary	9M-2341		
Fuel Secondary	1R-0750		
Hydraulic	1R-0741	132-8876	4T-3132
Power Train	1R-0719	132-8875	4T-3131
Air Primary	7W-5495		
Air Secondary	1P-7360		
D35HP Articulated Truck			3FD1-79
Engine Oil	1R-0716		
Fuel Primary	9M-2342		
Fuel Secondary	1R-0749		
Power Train	1R-0719	132-8875	4T-3131
Power Train	1R-0741	132-8876	4T-3132
Air Primary	7W-5495		
Air Secondary	1P-7360		
D40D Articulated Truck			2JJ1-UP
Engine Oil	1R-0716		
Fuel Primary	9M-2342		
Fuel Secondary	1R-0749		
Hydraulic	1R-0741	132-8876	4T-3132
Power Train	1R-0719	132-8875	4T-3131
Air Primary	7W-5495		
Air Secondary	1P-7360		

FILTER TYPE	PART NUMBER	HIGH EFFICIENCY	FIRE RESISTANT
D40D Articulated Truck			8TF1-UP
Engine Oil	1R-0716		
Fuel Primary	9M-2342		
Fuel Secondary	1R-0749		
Hydraulic	1R-0741	132-8876	4T-3132
Power Train	1R-0719	132-8875	4T-3131
Air Primary	7W-5495		
Air Secondary	1P-7360		
D44B Articulated Truck			8SD1-UP
Engine Oil	1R-0716		
Fuel Primary	9M-2342		
Hydraulic	1R-0741	132-8876	4T-3132
Power Train	1R-0719	132-8875	4T-3131
Air Primary	1P-8483		
Air Secondary	1P-8482		
D250B Articulated Truck			5WD1-550
Engine Oil	1R-0739		
Fuel Primary	9M-2341		
Fuel Secondary	1R-0750		
Hydraulic	1R-0741	132-8876	4T-3132
Power Train	1R-0719	132-8875	4T-3131
Air Primary	7W-5495		
Air Secondary	1P-7360		
D250D Articulated Truck			6NG1-UP
Engine Oil	1R-0739		
Fuel Primary	9M-2341		
Fuel Secondary	1R-0751		
Power Train	1R-0719	132-8875	4T-3131
Power Train	1R-0741	132-8876	4T-3132
Air Primary	7W-5316		
Air Secondary	2S-1287		
D250D Articulated Truck			9MG1-UP
Engine Oil	1R-0739		
Fuel Primary	9M-2341		
Fuel Secondary	1R-0751		
Power Train	1R-0719	132-8875	4T-3131
Power Train	1R-0741	132-8876	4T-3132
Air Primary	7W-5316		
Air Secondary	2S-1287		
D250E Articulated Truck			5TN1-UP
Engine Oil	1R-0739		
Fuel Primary	9M-2341		
Fuel Secondary	1R-0750		
Hydraulic	1R-0741	132-8876	4T-3132
Power Train	1R-0719	132-8875	4T-3131
Air Primary	6I-0273		
Air Secondary	6I-0274		

a - For quantities, refer to parts book.

Filters - Articulated Trucks

FILTER TYPE	PART NUMBER	HIGH EFFICIENCY	FIRE RESISTANT
D250E Series II Articulated Truck			4PS1-UP
Engine Oil	1R-0739		
Fuel Primary	9M-2341		
Fuel Secondary	1R-0750		
Hydraulic	1R-0741	132-8876	4T-3132
Power Train	1R-0719	132-8875	4T-3131
Air Primary	6I-0273		
Air Secondary	6I-0274		
D300B Articulated Truck			4SD1-573
Engine Oil	1R-0739		
Fuel Primary	9M-2341		
Fuel Secondary	1R-0750		
Hydraulic	1R-0741	132-8876	4T-3132
Power Train	1R-0719	132-8875	4T-3131
Air Primary	7W-5495		
Air Secondary	1P-7360		
D300D Articulated Truck			5MG1-UP
Engine Oil	1R-0739		
Fuel Primary	9M-2341		
Fuel Secondary	1R-0750		
Power Train	1R-0719	132-8875	4T-3131
Power Train	1R-0741	132-8876	4T-3132
Air Primary	7W-5495		
Air Secondary	1P-7360		
D300E Articulated Truck			7FN1-UP
Engine Oil	1R-0739		
Fuel Primary	9M-2341		
Fuel Secondary	1R-0750		
Hydraulic	1R-0741	132-8876	4T-3132
Power Train	1R-0719	132-8875	4T-3131
Air Primary	6I-0273		
Air Secondary	6I-0274		
D300E Series II Articulated Truck			5KS1-UP
Engine Oil	1R-0739		
Fuel Primary	9M-2341		
Fuel Secondary	1R-0750		
Hydraulic	1R-0741	132-8876	4T-3132
Power Train	1R-0719	132-8875	4T-3131
Air Primary	6I-0273		
Air Secondary	6I-0274		
D350C Articulated Truck			8XC1-404
Engine Oil	1R-0739		
Fuel Primary	9M-2341		
Fuel Secondary	1R-0750		
Hydraulic	1R-0741	132-8876	4T-3132
Power Train	1R-0719	132-8875	4T-3131
Air Primary	7W-5495		
Air Secondary	1P-7360		

FILTER TYPE	PART NUMBER	HIGH EFFICIENCY	FIRE RESISTANT
D350D Articulated Truck			1HK1-673
Engine Oil	1R-0739		
Fuel Primary	9M-2341		
Fuel Secondary	1R-0750		
Hydraulic	1R-0741	132-8876	4T-3132
Power Train	1R-0719	132-8875	4T-3131
Air Primary	6I-0273		
Air Primary	7W-5495		
Air Secondary	1P-7360		
Air Secondary	6I-0274		
D350D Articulated Truck			3AJ1-414
Engine Oil	1R-0739		
Fuel Primary	9M-2341		
Fuel Secondary	1R-0750		
Hydraulic	1R-0741	132-8876	4T-3132
Power Train	1R-0719	132-8875	4T-3131
Air Primary	6I-0273		
Air Primary	7W-5495		
Air Secondary	1P-7360		
Air Secondary	6I-0274		
D350D Articulated Truck			9RF1-UP
Engine Oil	1R-0739		
Fuel Primary	9M-2341		
Fuel Secondary	1R-0750		
Hydraulic	1R-0741	132-8876	4T-3132
Power Train	1R-0719	132-8875	4T-3131
Air Primary	6I-0273		
Air Primary	7W-5495		
Air Secondary	1P-7360		
Air Secondary	6I-0274		
D350E Articulated Truck			9LR1-UP
Engine Oil	1R-0716		
Fuel Primary	9M-2342		
Fuel Secondary	1R-0749		
Hydraulic	1R-0741	132-8876	4T-3132
Power Train	1R-0719	132-8875	4T-3131
Air Primary	6I-0273		
Air Secondary	6I-0274		
D350E Series II Articulated Truck			2XW1-UP
Engine Oil	1R-0716		
Fuel Primary	133-5673		
Fuel Secondary	1R-0749		
Hydraulic	132-8876		
Power Train	1R-0719	132-8875	4T-3131
Air Primary	6I-0273		
Air Secondary	6I-0274		

a - For quantities, refer to parts book.

Filters - Articulated Trucks, Backhoe Loaders

FILTER TYPE	PART NUMBER	HIGH EFFICIENCY	FIRE RESISTANT
D400 Articulated Truck			1MD1-246
Engine Oil	1R-0716		
Fuel Primary	9M-2342		
Fuel Secondary	1R-0749		
Hydraulic	1R-0741	132-8876	4T-3132
Power Train	1R-0719	132-8875	4T-3131
Air Primary	7W-5495		
Air Secondary	1P-7360		
D400D Articulated Truck			2JJ1-UP
Engine Oil	1R-0716		
Fuel Primary	9M-2342		
Fuel Secondary	1R-0749		
Hydraulic	1R-0741	132-8876	4T-3132
Power Train	1R-0719	132-8875	4T-3131
Air Primary	7W-5495		
Air Secondary	1P-7360		
D400D Articulated Truck			8TF1-UP
Engine Oil	1R-0716		
Fuel Primary	9M-2342		
Fuel Secondary	1R-0749		
Hydraulic	1R-0741	132-8876	4T-3132
Power Train	1R-0719	132-8875	4T-3131
Air Primary	7W-5495		
Air Secondary	1P-7360		
D400E Articulated Truck			2YR1-UP
Engine Oil	1R-0716		
Fuel Primary	9M-2342		
Fuel Secondary	1R-0749		
Hydraulic	1R-0741	132-8876	4T-3132
Power Train	1R-0719	132-8875	4T-3131
Air Primary	6I-0273		
Air Secondary	6I-0274		
D400E Series II Articulated Truck			8PS1-UP
Engine Oil	1R-0716		
Fuel Primary	133-5673		
Fuel Secondary	1R-0749		
Hydraulic	132-8876		
Power Train	1R-0719	132-8875	4T-3131
Air Primary	123-6855		
Air Secondary	123-6856		
D550B Articulated Truck			5ND1-UP
Engine Oil	1R-0716		
Fuel Primary	9M-2342		
Hydraulic	1R-0741	132-8876	4T-3132
Power Train	1R-0719	132-8875	4T-3131
Air Primary	1P-8483		
Air Secondary	1P-8482		

FILTER TYPE	PART NUMBER	HIGH EFFICIENCY	FIRE RESISTANT
BACKHOE LOADERS ^a			
416 Backhoe Loader			5PC1-10761
Engine Oil	7W-2327		
Fuel Primary	7W-6268		
Hydraulic	1R-0722	139-1536	4T-3134
Hydraulic	1R-0735	139-1537	104-6931
Power Train	119-4740		
Air Primary	8N-5504		
Air Secondary	4W-6691		
416 Series II Backhoe Loader			5PC10762-UP
Engine Oil	7W-2327		
Fuel Primary	7W-6268		
Hydraulic	1R-0722	139-1536	4T-3134
Hydraulic	1R-0735	139-1537	104-6931
Power Train	119-4740		
Air Primary	8N-5504		
Air Secondary	4W-6691		
416B Backhoe Loader			8SG1-11999
Engine Oil	7W-2326		
Engine Oil	7W-2327		
Fuel Secondary	159-6102		
Hydraulic	9T-0973	126-1817	134-3014
Power Train	119-4740		
Air Primary	8N-5504		
Air Secondary	4W-6691		
416B Backhoe Loader			8SG12000-UP
Engine Oil	7W-2326		
Engine Oil	7W-2327		
Fuel Primary	131-1812		
Fuel Secondary	159-6102		
Hydraulic	9T-0973	126-1817	134-3014
Power Train	119-4740		
Air Primary	8N-5504		
Air Secondary	4W-6691		
416B Backhoe Loader			8ZK1-5999
Engine Oil	7W-2326		
Engine Oil	7W-2327		
Fuel Secondary	159-6102		
Hydraulic	108-1153	126-1817	134-3014
Power Train	119-4740		
Air Primary	8N-5504		
Air Secondary	4W-6691		
416B Backhoe Loader			8ZK6000-UP
Engine Oil	7W-2326		
Engine Oil	7W-2327		
Fuel Primary	131-1812		
Fuel Secondary	159-6102		
Hydraulic	108-1153	126-1817	134-3014

a - For quantities, refer to parts book.

Filters - Backhoe Loaders

FILTER TYPE	PART NUMBER	HIGH EFFICIENCY	FIRE RESISTANT
416B Backhoe Loader (cont.)		8ZK6000-UP	
Power Train	119-4740		
Air Primary	8N-5504		
Air Secondary	4W-6691		
416C Backhoe Loader		1AR1-UP	
Engine Oil	7W-2326		
Engine Oil	7W-2327		
Fuel Primary	131-1812		
Fuel Secondary	159-6102		
Hydraulic	108-1153	126-1817	134-3014
Power Train	119-4740		
Air Primary	110-6326		
Air Secondary	110-6331		
416C Backhoe Loader		1BR1-UP	
Engine Oil	7W-2326		
Engine Oil	7W-2327		
Fuel Primary	131-1812		
Fuel Secondary	159-6102		
Hydraulic	108-1153	126-1817	134-3014
Hydraulic	9T-0973	126-1817	134-3014
Power Train	119-4740		
Air Primary	110-6326		
Air Secondary	110-6331		
416C Backhoe Loader		1KR1-UP	
Engine Oil	7W-2326		
Engine Oil	7W-2327		
Fuel Primary	131-1812		
Fuel Secondary	159-6102		
Hydraulic	108-1153	126-1817	134-3014
Power Train	119-4740		
Air Primary	110-6326		
Air Secondary	110-6331		
416C Backhoe Loader		1LR1-UP	
Engine Oil	7W-2326		
Engine Oil	7W-2327		
Fuel Primary	131-1812		
Fuel Secondary	159-6102		
Hydraulic	108-1153	126-1817	134-3014
Hydraulic	9T-0973	126-1817	134-3014
Power Train	119-4740		
Air Primary	110-6326		
Air Secondary	110-6331		
416C Backhoe Loader		1WR1-8115	
Engine Oil	7W-2326		
Engine Oil	7W-2327		
Fuel Primary	131-1812		
Fuel Secondary	159-6102		
Hydraulic	108-1153	126-1817	134-3014

FILTER TYPE	PART NUMBER	HIGH EFFICIENCY	FIRE RESISTANT
416C Backhoe Loader (cont.)		1WR1-8115	
Hydraulic	134-3014		
Power Train	119-4740		
Air Primary	110-6326		
Air Secondary	110-6331		
416C Backhoe Loader		1WR8116-UP	
Engine Oil	7W-2326		
Fuel Primary	131-1812		
Fuel Secondary	159-6102		
Hydraulic	126-1817		
Power Train	119-4740		
Air Primary	110-6326		
Air Secondary	110-6331		
416C Backhoe Loader		1XR1-2183	
Engine Oil	7W-2326		
Engine Oil	7W-2327		
Fuel Primary	131-1812		
Fuel Secondary	159-6102		
Hydraulic	108-1153	126-1817	134-3014
Hydraulic	9T-0973	126-1817	134-3014
Power Train	119-4740		
Air Primary	110-6326		
Air Secondary	110-6331		
416C Backhoe Loader		1XR2184-2249	
Engine Oil	7W-2326		
Fuel Primary	131-1812		
Fuel Secondary	159-6102		
Hydraulic	126-1817		
Power Train	119-4740		
Air Primary	110-6326		
Air Secondary	110-6331		
416C Backhoe Loader		1XR2250-UP	
Engine Oil	7W-2326		
Engine Oil	7W-2327		
Fuel Primary	131-1812		
Fuel Secondary	159-6102		
Hydraulic	108-1153	126-1817	134-3014
Power Train	119-4740		
Air Primary	110-6326		
Air Secondary	110-6331		
416C Backhoe Loader		4ZN1-16043	
Engine Oil	7W-2326		
Engine Oil	7W-2327		
Fuel Primary	131-1812		
Fuel Secondary	159-6102		
Hydraulic	108-1153	126-1817	134-3014
Power Train	119-4740		
Air Primary	110-6326		

a - For quantities, refer to parts book.

Filters - Backhoe Loaders

FILTER TYPE	PART NUMBER	HIGH EFFICIENCY	FIRE RESISTANT
416C Backhoe Loader (cont.)		4ZN1-16043	
Air Secondary	110-6331		
416C Backhoe Loader		4ZN16044-UP	
Engine Oil	7W-2326		
Fuel Primary	131-1812		
Fuel Secondary	159-6102		
Hydraulic	126-1817		
Power Train	119-4740		
Air Primary	110-6326		
Air Secondary	110-6331		
416C Backhoe Loader		5YN1-15147	
Engine Oil	7W-2326		
Engine Oil	7W-2327		
Fuel Primary	131-1812		
Fuel Secondary	159-6102		
Hydraulic	108-1153	126-1817	134-3014
Hydraulic	9T-0973	126-1817	134-3014
Power Train	119-4740		
Air Primary	110-6326		
Air Secondary	110-6331		
416C Backhoe Loader		5YN15148-UP	
Engine Oil	7W-2326		
Fuel Primary	131-1812		
Fuel Secondary	159-6102		
Hydraulic	126-1817		
Power Train	119-4740		
Air Primary	110-6326		
Air Secondary	110-6331		
416D Backhoe Loader		BFP1-UP	
Engine Oil	7W-2326		
Fuel Primary	131-1812		
Fuel Secondary	159-6102		
Hydraulic	126-1817		
Power Train	119-4740		
Air Primary	110-6326		
Air Secondary	110-6331		
416D Backhoe Loader		BGJ1-UP	
Engine Oil	7W-2326		
Fuel Primary	131-1812		
Fuel Secondary	159-6102		
Hydraulic	126-1817		
Power Train	119-4740		
Air Primary	110-6326		
Air Secondary	110-6331		
416D Backhoe Loader		BKG1-UP	
Engine Oil	7W-2326		
Fuel Primary	131-1812		
Fuel Secondary	159-6102		

FILTER TYPE	PART NUMBER	HIGH EFFICIENCY	FIRE RESISTANT
416D Backhoe Loader (cont.)		BKG1-UP	
Hydraulic	126-1817		
Power Train	119-4740		
Air Primary	110-6326		
Air Secondary	110-6331		
420D Backhoe Loader		BKC1-UP	
Engine Oil	7W-2326		
Fuel Primary	131-1812		
Fuel Secondary	159-6102		
Power Train	119-4740		
Power Train	126-1817		
Air Primary	110-6326		
Air Secondary	110-6331		
420D Backhoe Loader		BLN1-UP	
Engine Oil	7W-2326		
Fuel Primary	131-1812		
Fuel Secondary	159-6102		
Power Train	119-4740		
Power Train	126-1817		
Air Primary	110-6326		
Air Secondary	110-6331		
420D Backhoe Loader		BMC1-UP	
Engine Oil	7W-2326		
Fuel Primary	131-1812		
Fuel Secondary	159-6102		
Power Train	119-4740		
Power Train	126-1817		
Air Primary	110-6326		
Air Secondary	110-6331		
420D Backhoe Loader		FDP1-UP	
Engine Oil	7W-2326		
Fuel Primary	131-1812		
Fuel Secondary	159-6102		
Hydraulic	126-1817		
Power Train	119-4740		
Air Primary	110-6326		
Air Secondary	110-6331		
424D Backhoe Loader		BGP1-UP	
Engine Oil	7W-2326		
Fuel Primary	131-1812		
Fuel Secondary	159-6102		
Hydraulic	126-1817		
Power Train	119-4740		
424D Backhoe Loader		BKR1-UP	
Engine Oil	7W-2326		
Fuel Primary	131-1812		
Fuel Secondary	159-6102		
Hydraulic	126-1817		

a - For quantities, refer to parts book.

Filters - Backhoe Loaders

FILTER TYPE	PART NUMBER	HIGH EFFICIENCY	FIRE RESISTANT
424D Backhoe Loader (cont.)		BKR1-UP	
Power Train	119-4740		
426 Backhoe Loader		7BC1-3476	
Engine Oil	7W-2327		
Fuel Primary	7W-6268		
Hydraulic	1R-0722	139-1536	4T-3134
Hydraulic	1R-0735	139-1537	104-6931
Power Train	119-4740		
Air Primary	8N-5504		
Air Secondary	4W-6691		
426 Series II Backhoe Loader		7BC3477-UP	
Engine Oil	7W-2327		
Fuel Primary	7W-6268		
Hydraulic	1R-0722	139-1536	4T-3134
Hydraulic	1R-0735	139-1537	104-6931
Power Train	119-4740		
Air Primary	8N-5504		
Air Secondary	4W-6691		
426B Backhoe Loader		5YJ1-2299	
Engine Oil	7W-2326		
Fuel Secondary	159-6102		
Hydraulic	9T-0973	126-1817	134-3014
Power Train	119-4740		
Air Primary	8N-5504		
Air Secondary	4W-6691		
426B Backhoe Loader		5YJ2300-UP	
Engine Oil	7W-2326		
Fuel Secondary	159-6102		
Hydraulic	108-1153	126-1817	134-3014
Hydraulic	9T-0973	126-1817	134-3014
Power Train	119-4740		
Air Primary	8N-5504		
Air Secondary	4W-6691		
426B Backhoe Loader		6KL1-1199	
Engine Oil	7W-2326		
Fuel Secondary	159-6102		
Hydraulic	9T-0973	126-1817	134-3014
Power Train	119-4740		
Air Primary	8N-5504		
Air Secondary	4W-6691		
426B Backhoe Loader		6KL1200-UP	
Engine Oil	7W-2326		
Fuel Primary	131-1812		
Fuel Secondary	159-6102		
Hydraulic	108-1153	126-1817	134-3014
Hydraulic	9T-0973	126-1817	134-3014
Power Train	119-4740		
Air Primary	8N-5504		

FILTER TYPE	PART NUMBER	HIGH EFFICIENCY	FIRE RESISTANT
426B Backhoe Loader (cont.)		6KL1200-UP	
Air Secondary	4W-6691		
426C Backhoe Loader		1CR1-863	
Engine Oil	7W-2326		
Fuel Primary	131-1812		
Fuel Secondary	159-6102		
Hydraulic	108-1153	126-1817	134-3014
Power Train	119-4740		
Air Primary	110-6326		
Air Secondary	110-6331		
426C Backhoe Loader		1CR864-UP	
Engine Oil	7W-2326		
Fuel Primary	131-1812		
Fuel Secondary	159-6102		
Hydraulic	126-1817		
Power Train	119-4740		
Air Primary	110-6326		
Air Secondary	110-6331		
426C Backhoe Loader		1ER1-863	
Engine Oil	7W-2326		
Fuel Primary	131-1812		
Fuel Secondary	159-6102		
Hydraulic	108-1153	126-1817	134-3014
Hydraulic	9T-0973	126-1817	134-3014
Power Train	119-4740		
Air Primary	110-6326		
Air Secondary	110-6331		
426C Backhoe Loader		1ER864-899	
Engine Oil	7W-2326		
Fuel Primary	131-1812		
Fuel Secondary	159-6102		
Hydraulic	126-1817		
Power Train	119-4740		
Air Primary	110-6326		
Air Secondary	110-6331		
426C Backhoe Loader		1ER900-UP	
Engine Oil	7W-2326		
Fuel Primary	131-1812		
Fuel Secondary	159-6102		
Hydraulic	108-1153	126-1817	134-3014
Power Train	119-4740		
Air Primary	110-6326		
Air Secondary	110-6331		
426C Backhoe Loader		1MR1-955	
Engine Oil	7W-2326		
Fuel Primary	131-1812		
Fuel Secondary	159-6102		
Hydraulic	108-1153	126-1817	134-3014

a - For quantities, refer to parts book.

Filters - Backhoe Loaders

FILTER TYPE	PART NUMBER	HIGH EFFICIENCY	FIRE RESISTANT
426C Backhoe Loader (cont.)			1MR1-955
Power Train	119-4740		
Air Primary	110-6326		
Air Secondary	110-6331		
426C Backhoe Loader			1MR956-UP
Engine Oil	7W-2326		
Fuel Primary	131-1812		
Fuel Secondary	159-6102		
Hydraulic	126-1817		
Power Train	119-4740		
Air Primary	110-6326		
Air Secondary	110-6331		
426C Backhoe Loader			1NR1-953
Engine Oil	7W-2326		
Fuel Primary	131-1812		
Fuel Secondary	159-6102		
Hydraulic	108-1153	126-1817	134-3014
Hydraulic	9T-0973	126-1817	134-3014
Power Train	119-4740		
Air Primary	110-6326		
Air Secondary	110-6331		
426C Backhoe Loader			1NR954-1049
Engine Oil	7W-2326		
Fuel Primary	131-1812		
Fuel Secondary	159-6102		
Hydraulic	126-1817		
Power Train	119-4740		
Air Primary	110-6326		
Air Secondary	110-6331		
426C Backhoe Loader			1NR1050-UP
Engine Oil	7W-2326		
Fuel Primary	131-1812		
Fuel Secondary	159-6102		
Hydraulic	108-1153	126-1817	134-3014
Power Train	119-4740		
Air Primary	110-6326		
Air Secondary	110-6331		
426C Backhoe Loader			1YR1-1516
Engine Oil	7W-2326		
Fuel Primary	131-1812		
Fuel Secondary	159-6102		
Hydraulic	108-1153	126-1817	134-3014
Power Train	119-4740		
Air Primary	110-6326		
Air Secondary	110-6331		
426C Backhoe Loader			1YR1517-UP
Engine Oil	7W-2326		
Fuel Primary	131-1812		

FILTER TYPE	PART NUMBER	HIGH EFFICIENCY	FIRE RESISTANT
426C Backhoe Loader (cont.)			1YR1517-UP
Fuel Secondary	159-6102		
Hydraulic	126-1817		
Power Train	119-4740		
Air Primary	110-6326		
Air Secondary	110-6331		
426C Backhoe Loader			1ZR1-925
Engine Oil	7W-2326		
Fuel Primary	131-1812		
Fuel Secondary	159-6102		
Hydraulic	108-1153	126-1817	134-3014
Hydraulic	9T-0973	126-1817	134-3014
Power Train	119-4740		
Air Primary	110-6326		
Air Secondary	110-6331		
426C Backhoe Loader			1ZR926-999
Engine Oil	7W-2326		
Fuel Primary	131-1812		
Fuel Secondary	159-6102		
Hydraulic	126-1817		
Power Train	119-4740		
Air Primary	110-6326		
Air Secondary	110-6331		
426C Backhoe Loader			1ZR1000-UP
Engine Oil	7W-2326		
Fuel Primary	131-1812		
Fuel Secondary	159-6102		
Hydraulic	108-1153	126-1817	134-3014
Power Train	119-4740		
Air Primary	110-6326		
Air Secondary	110-6331		
426C Backhoe Loader			6XN1-3615
Engine Oil	7W-2326		
Fuel Primary	131-1812		
Fuel Secondary	159-6102		
Hydraulic	108-1153	126-1817	134-3014
Power Train	119-4740		
Air Primary	110-6326		
Air Secondary	110-6331		
426C Backhoe Loader			6XN3616-UP
Engine Oil	7W-2326		
Fuel Primary	131-1812		
Fuel Secondary	159-6102		
Hydraulic	126-1817		
Power Train	119-4740		
Air Primary	110-6326		
Air Secondary	110-6331		

a - For quantities, refer to parts book.

Filters - Backhoe Loaders

FILTER TYPE	PART NUMBER	HIGH EFFICIENCY	FIRE RESISTANT
426C Backhoe Loader		7WN1-938	
Engine Oil	7W-2326		
Fuel Primary	131-1812		
Fuel Secondary	159-6102		
Hydraulic	108-1153	126-1817	134-3014
Hydraulic	9T-0973	126-1817	134-3014
Power Train	119-4740		
Air Primary	110-6326		
Air Secondary	110-6331		
426C Backhoe Loader		7WN939-1099	
Engine Oil	7W-2326		
Fuel Primary	131-1812		
Fuel Secondary	159-6102		
Hydraulic	126-1817		
Power Train	119-4740		
Air Primary	110-6326		
Air Secondary	110-6331		
426C Backhoe Loader		7WN1100-UP	
Engine Oil	7W-2326		
Fuel Primary	131-1812		
Fuel Secondary	159-6102		
Hydraulic	108-1153	126-1817	134-3014
Power Train	119-4740		
Air Primary	110-6326		
Air Secondary	110-6331		
428 Backhoe Loader		6TC1-6563	
Engine Oil	7W-2327		
Fuel Primary	7W-6268		
Hydraulic	1R-0722	139-1536	4T-3134
Hydraulic	1R-0735	139-1537	104-6931
Power Train	119-4740		
Air Primary	8N-5504		
Air Secondary	4W-6691		
428 Series II Backhoe Loader		6TC6564-UP	
Engine Oil	7W-2327		
Fuel Primary	7W-6268		
Hydraulic	1R-0722	139-1536	4T-3134
Hydraulic	1R-0735	139-1537	104-6931
Power Train	119-4740		
Air Primary	8N-5504		
Air Secondary	4W-6691		
428B Backhoe Loader		3KK1-2999	
Engine Oil	7W-2326		
Fuel Secondary	159-6102		
Hydraulic	9T-0973	126-1817	134-3014
Power Train	119-4740		
Air Primary	8N-5504		
Air Secondary	4W-6691		

FILTER TYPE	PART NUMBER	HIGH EFFICIENCY	FIRE RESISTANT
428B Backhoe Loader		7EJ1-5999	
Engine Oil	7W-2326		
Engine Oil	7W-2327		
Fuel Primary	131-1812		
Fuel Secondary	159-6102		
Hydraulic	9T-0973	126-1817	134-3014
Hydraulic	108-1153	126-1817	134-3014
Power Train	119-4740		
Air Primary	8N-5504		
Air Secondary	4W-6691		
428B Backhoe Loader		7EJ6000-UP	
Engine Oil	7W-2326		
Engine Oil	7W-2327		
Fuel Primary	131-1812		
Fuel Secondary	159-6102		
Hydraulic	9T-0973	126-1817	134-3014
Power Train	119-4740		
Air Primary	8N-5504		
Air Secondary	4W-6691		
428C Backhoe Loader		1HR1-300	
Engine Oil	7W-2326		
Fuel Primary	131-1812		
Fuel Secondary	159-6102		
Hydraulic	9T-0973	126-1817	134-3014
Power Train	119-4740		
Air Primary	110-6326		
Air Secondary	110-6331		
428C Backhoe Loader		1SR1-UP	
Engine Oil	7W-2326		
Fuel Primary	131-1812		
Fuel Secondary	159-6102		
Hydraulic	126-1817		
Power Train	119-4740		
Air Primary	110-6326		
Air Secondary	110-6331		
428C Backhoe Loader		2CR1-UP	
Engine Oil	7W-2326		
Fuel Primary	131-1812		
Fuel Secondary	159-6102		
Hydraulic	126-1817		
Power Train	119-4740		
Air Primary	110-6326		
Air Secondary	110-6331		
428C Backhoe Loader		8RN1-4088	
Engine Oil	7W-2326		
Fuel Primary	131-1812		
Fuel Secondary	159-6102		
Hydraulic	9T-0973	126-1817	134-3014

a - For quantities, refer to parts book.

Filters - Backhoe Loaders

FILTER TYPE	PART NUMBER	HIGH EFFICIENCY	FIRE RESISTANT
428C Backhoe Loader (cont.)		8RN1-4088	
Power Train	119-4740		
Air Primary	110-6326		
Air Secondary	110-6331		
428C Backhoe Loader		8RN4089-UP	
Engine Oil	7W-2326		
Fuel Primary	131-1812		
Fuel Secondary	159-6102		
Hydraulic	126-1817		
Power Train	119-4740		
Air Primary	110-6326		
Air Secondary	110-6331		
428D Backhoe Loader		BLL1-UP	
Engine Oil	7W-2326		
Fuel Primary	131-1812		
Fuel Secondary	159-6102		
Hydraulic	126-1817		
Power Train	119-4740		
428D Backhoe Loader		BMT1-UP	
Engine Oil	7W-2326		
Fuel Primary	131-1812		
Fuel Secondary	159-6102		
Hydraulic	126-1817		
Power Train	119-4740		
428D Backhoe Loader		BNB1-UP	
Engine Oil	7W-2326		
Fuel Primary	131-1812		
Fuel Secondary	159-6102		
Hydraulic	126-1817		
Power Train	119-4740		
428D Backhoe Loader		BNS1-UP	
Engine Oil	7W-2326		
Fuel Primary	131-1812		
Fuel Secondary	159-6102		
Hydraulic	126-1817		
Power Train	119-4740		
430D Backhoe Loader		BML1-UP	
Engine Oil	7W-2326		
Fuel Primary	131-1812		
Fuel Secondary	159-6102		
Hydraulic	126-1817		
Power Train	119-4740		
Air Primary	110-6326		
Air Secondary	110-6331		
430D Backhoe Loader		BNK1-UP	
Engine Oil	7W-2326		
Fuel Primary	131-1812		
Fuel Secondary	159-6102		

FILTER TYPE	PART NUMBER	HIGH EFFICIENCY	FIRE RESISTANT
430D Backhoe Loader (cont.)		BNK1-UP	
Hydraulic	126-1817		
Power Train	119-4740		
Air Primary	110-6326		
Air Secondary	110-6331		
432D Backhoe Loader		BLD1-UP	
Engine Oil	7W-2326		
Fuel Primary	131-1812		
Fuel Secondary	159-6102		
Hydraulic	126-1817		
Power Train	119-4740		
436 Backhoe Loader		5KF1-805	
Engine Oil	7W-2327		
Fuel Primary	7W-6268		
Hydraulic	1R-0722	139-1536	4T-3134
Hydraulic	1R-0735	139-1537	104-6931
Power Train	119-4740		
Air Primary	8N-5504		
Air Secondary	4W-6691		
436 Series II Backhoe Loader		5KF806-UP	
Engine Oil	7W-2327		
Fuel Primary	7W-6268		
Hydraulic	1R-0722	139-1536	4T-3134
Hydraulic	1R-0735	139-1537	104-6931
Power Train	119-4740		
Air Primary	8N-5504		
Air Secondary	4W-6691		
436B Backhoe Loader		6MJ1-UP	
Engine Oil	7W-2326		
Fuel Secondary	159-6102		
Hydraulic	9T-0973	126-1817	134-3014
Power Train	119-4740		
Air Primary	8N-5504		
Air Secondary	4W-6691		
436B Backhoe Loader		7FL1-UP	
Engine Oil	7W-2326		
Fuel Primary	131-1812		
Fuel Secondary	159-6102		
Hydraulic	9T-0973	126-1817	134-3014
Power Train	119-4740		
Air Primary	8N-5504		
Air Secondary	4W-6691		
436C Backhoe Loader		1FR1-1415	
Engine Oil	7W-2326		
Fuel Primary	131-1812		
Fuel Secondary	159-6102		
Hydraulic	108-1153	126-1817	134-3014
Power Train	119-4740		

a - For quantities, refer to parts book.

Filters - Backhoe Loaders

FILTER TYPE	PART NUMBER	HIGH EFFICIENCY	FIRE RESISTANT
436C Backhoe Loader (cont.)		1FR1-1415	
Air Primary	110-6326		
Air Secondary	110-6331		
436C Backhoe Loader		1FR1416-UP	
Engine Oil	7W-2326		
Fuel Primary	131-1812		
Fuel Secondary	159-6102		
Hydraulic	126-1817		
Power Train	119-4740		
Air Primary	110-6326		
Air Secondary	110-6331		
436C Backhoe Loader		1GR1-915	
Engine Oil	7W-2326		
Fuel Primary	131-1812		
Fuel Secondary	159-6102		
Hydraulic	108-1153	126-1817	134-3014
Hydraulic	9T-0973	126-1817	134-3014
Power Train	119-4740		
Air Primary	110-6326		
Air Secondary	110-6331		
436C Backhoe Loader		1GR916-UP	
Engine Oil	7W-2326		
Fuel Primary	131-1812		
Fuel Secondary	159-6102		
Hydraulic	126-1817		
Power Train	119-4740		
Air Primary	110-6326		
Air Secondary	110-6331		
436C Backhoe Loader		1GR950-UP	
Engine Oil	7W-2326		
Fuel Primary	131-1812		
Fuel Secondary	159-6102		
Hydraulic	108-1153	126-1817	134-3014
Power Train	119-4740		
Air Primary	110-6326		
Air Secondary	110-6331		
436C Backhoe Loader		1PR1-1598	
Engine Oil	7W-2326		
Fuel Primary	131-1812		
Fuel Secondary	159-6102		
Hydraulic	108-1153	126-1817	134-3014
Power Train	119-4740		
Air Primary	110-6326		
Air Secondary	110-6331		
436C Backhoe Loader		1PR1599-UP	
Engine Oil	7W-2326		
Fuel Primary	131-1812		
Fuel Secondary	159-6102		

FILTER TYPE	PART NUMBER	HIGH EFFICIENCY	FIRE RESISTANT
436C Backhoe Loader (cont.)		1PR1599-UP	
Hydraulic	126-1817		
Power Train	119-4740		
Air Primary	110-6326		
Air Secondary	110-6331		
436C Backhoe Loader		1RR1-997	
Engine Oil	7W-2326		
Fuel Primary	131-1812		
Fuel Secondary	159-6102		
Hydraulic	108-1153	126-1817	134-3014
Hydraulic	9T-0973	126-1817	134-3014
Power Train	119-4740		
Air Primary	110-6326		
Air Secondary	110-6331		
436C Backhoe Loader		1RR998-UP	
Engine Oil	7W-2326		
Fuel Primary	131-1812		
Fuel Secondary	159-6102		
Hydraulic	108-1153	126-1817	134-3014
Power Train	119-4740		
Air Primary	110-6326		
Air Secondary	110-6331		
436C Backhoe Loader		2AR1-1603	
Engine Oil	7W-2326		
Fuel Primary	131-1812		
Fuel Secondary	159-6102		
Hydraulic	108-1153	126-1817	134-3014
Hydraulic	134-3014		
Power Train	119-4740		
Air Primary	110-6326		
Air Secondary	110-6331		
436C Backhoe Loader		2AR1604-UP	
Engine Oil	7W-2326		
Fuel Primary	131-1812		
Fuel Secondary	159-6102		
Hydraulic	126-1817		
Power Train	119-4740		
Air Primary	110-6326		
Air Secondary	110-6331		
436C Backhoe Loader		2BR1-910	
Engine Oil	7W-2326		
Fuel Primary	131-1812		
Fuel Secondary	159-6102		
Hydraulic	108-1153	126-1817	134-3014
Hydraulic	9T-0973	126-1817	134-3014
Power Train	119-4740		
Air Primary	110-6326		
Air Secondary	110-6331		

a - For quantities, refer to parts book.

Filters - Backhoe Loaders

FILTER TYPE	PART NUMBER	HIGH EFFICIENCY	FIRE RESISTANT
436C Backhoe Loader		2BR911-UP	
Engine Oil	7W-2326		
Fuel Primary	131-1812		
Fuel Secondary	159-6102		
Hydraulic	108-1153	126-1817	134-3014
Power Train	119-4740		
Air Primary	110-6326		
Air Secondary	110-6331		
436C Backhoe Loader		8TN1-924	
Engine Oil	7W-2326		
Fuel Primary	131-1812		
Fuel Secondary	159-6102		
Hydraulic	108-1153	126-1817	134-3014
Power Train	119-4740		
Air Primary	110-6326		
Air Secondary	110-6331		
436C Backhoe Loader		8TN925-UP	
Engine Oil	7W-2326		
Fuel Primary	131-1812		
Fuel Secondary	159-6102		
Hydraulic	126-1817		
Power Train	119-4740		
Air Primary	110-6326		
Air Secondary	110-6331		
436C Backhoe Loader		9JN1-883	
Engine Oil	7W-2326		
Fuel Primary	131-1812		
Fuel Secondary	159-6102		
Hydraulic	108-1153	126-1817	134-3014
Hydraulic	9T-0973	126-1817	134-3014
Power Train	119-4740		
Air Primary	110-6326		
Air Secondary	110-6331		
436C Backhoe Loader		9JN884-UP	
Engine Oil	7W-2326		
Fuel Primary	131-1812		
Fuel Secondary	159-6102		
Hydraulic	108-1153	126-1817	134-3014
Power Train	119-4740		
Air Primary	110-6326		
Air Secondary	110-6331		
438 Backhoe Loader		3DJ1-827	
Engine Oil	7W-2327		
Fuel Primary	7W-6268		
Hydraulic	1R-0722	139-1536	4T-3134
Hydraulic	1R-0735	139-1537	104-6931
Power Train	119-4740		
Air Primary	8N-5504		

FILTER TYPE	PART NUMBER	HIGH EFFICIENCY	FIRE RESISTANT
438 Backhoe Loader (cont.)		3DJ1-827	
Air Secondary	4W-6691		
438 Series II Backhoe Loader		3DJ828-UP	
Engine Oil	7W-2327		
Fuel Primary	7W-6268		
Hydraulic	1R-0722	139-1536	4T-3134
Hydraulic	1R-0735	139-1537	104-6931
Power Train	119-4740		
Air Primary	8N-5504		
Air Secondary	4W-6691		
438B Backhoe Loader		3KK3000-UP	
Engine Oil	7W-2326		
Fuel Primary	131-1812		
Fuel Secondary	159-6102		
Hydraulic	9T-0973	126-1817	134-3014
Hydraulic	108-1153	126-1817	134-3014
Power Train	119-4740		
Air Primary	8N-5504		
Air Secondary	4W-6691		
438C Backhoe Loader		1JR1-1106	
Engine Oil	7W-2326		
Fuel Primary	131-1812		
Fuel Secondary	159-6102		
Hydraulic	108-1153	126-1817	134-3014
Power Train	119-4740		
Air Primary	110-6326		
Air Secondary	110-6331		
438C Backhoe Loader		1JR1107-UP	
Engine Oil	7W-2326		
Fuel Primary	131-1812		
Fuel Secondary	159-6102		
Hydraulic	126-1817		
Power Train	119-4740		
Air Primary	110-6326		
Air Secondary	110-6331		
438C Backhoe Loader		1TR1-1283	
Engine Oil	7W-2326		
Fuel Primary	131-1812		
Fuel Secondary	159-6102		
Hydraulic	108-1153	126-1817	134-3014
Power Train	119-4740		
Air Primary	110-6326		
Air Secondary	110-6331		
438C Backhoe Loader		1TR1284-1549	
Engine Oil	7W-2326		
Fuel Primary	131-1812		
Fuel Secondary	159-6102		
Hydraulic	126-1817		

a - For quantities, refer to parts book.

Filters - Backhoe Loaders

FILTER TYPE	PART NUMBER	HIGH EFFICIENCY	FIRE RESISTANT
438C Backhoe Loader (cont.)		1TR1284-1549	
Power Train	119-4740		
Air Primary	110-6326		
Air Secondary	110-6331		
438C Backhoe Loader		1TR1550-UP	
Engine Oil	7W-2326		
Fuel Primary	131-1812		
Fuel Secondary	159-6102		
Hydraulic	108-1153	126-1817	134-3014
Power Train	119-4740		
Air Primary	110-6326		
Air Secondary	110-6331		
438C Backhoe Loader		2DR1-2716	
Engine Oil	7W-2326		
Fuel Primary	131-1812		
Fuel Secondary	159-6102		
Hydraulic	108-1153	126-1817	134-3014
Hydraulic	126-1817		
Power Train	119-4740		
Air Primary	110-6326		
Air Secondary	110-6331		
438C Backhoe Loader		2DR2717-3249	
Engine Oil	7W-2326		
Fuel Primary	131-1812		
Fuel Secondary	159-6102		
Hydraulic	126-1817		
Power Train	119-4740		
Air Primary	110-6326		
Air Secondary	110-6331		
438C Backhoe Loader		2DR3250-UP	
Engine Oil	7W-2326		
Fuel Primary	131-1812		
Fuel Secondary	159-6102		
Hydraulic	108-1153	126-1817	134-3014
Power Train	119-4740		
Air Primary	110-6326		
Air Secondary	110-6331		
438C Backhoe Loader		9KN1-1060	
Engine Oil	7W-2326		
Fuel Primary	131-1812		
Fuel Secondary	159-6102		
Hydraulic	108-1153	126-1817	134-3014
Power Train	119-4740		
Air Primary	110-6326		
Air Secondary	110-6331		
438C Backhoe Loader		9KN1061-1199	
Engine Oil	7W-2326		
Fuel Primary	131-1812		

FILTER TYPE	PART NUMBER	HIGH EFFICIENCY	FIRE RESISTANT
438C Backhoe Loader (cont.)		9KN1061-1199	
Fuel Secondary	159-6102		
Hydraulic	126-1817		
Power Train	119-4740		
Air Primary	110-6326		
Air Secondary	110-6331		
438C Backhoe Loader		9KN1400-UP	
Engine Oil	7W-2326		
Fuel Primary	131-1812		
Fuel Secondary	159-6102		
Hydraulic	126-1817		
Power Train	119-4740		
Air Primary	110-6326		
Air Secondary	110-6331		
438D Backhoe Loader		BPE1-UP	
Engine Oil	7W-2326		
Fuel Primary	131-1812		
Fuel Secondary	159-6102		
Hydraulic	126-1817		
Power Train	119-4740		
438D Backhoe Loader		BPN1-UP	
Engine Oil	7W-2326		
Fuel Primary	131-1812		
Fuel Secondary	159-6102		
Hydraulic	126-1817		
Power Train	119-4740		
442D Backhoe Loader		BRG1-UP	
Engine Oil	7W-2326		
Fuel Primary	131-1812		
Fuel Secondary	159-6102		
Hydraulic	126-1817		
Power Train	119-4740		
442D Backhoe Loader		BRY1-UP	
Engine Oil	7W-2326		
Fuel Primary	131-1812		
Fuel Secondary	159-6102		
Hydraulic	126-1817		
Power Train	119-4740		
446 Backhoe Loader		6XF1-UP	
Engine Oil	1R-0714		
Fuel Primary	9M-2341		
Fuel Secondary	1R-0750		
Hydraulic	1R-0722	139-1536	4T-3134
Hydraulic	1R-0735	139-1537	104-6931
Power Train	1G-8878	102-2828	156-0214
Power Train	9T-9054	9T-7656	
Air Primary	7W-3920		
Air Secondary	7C-1062		

a - For quantities, refer to parts book.

Filters - Backhoe Loaders, Excavators

FILTER TYPE	PART NUMBER	HIGH EFFICIENCY	FIRE RESISTANT
446B Backhoe Loader		5BL1-2499	
Engine Oil	1R-0714		
Fuel Primary	9M-2341		
Fuel Secondary	1R-0753		
Hydraulic	108-1153	126-1817	134-3014
Power Train	1G-8878	102-2828	156-0214
Air Primary	108-0671		
Air Primary	7W-3920		
Air Secondary	108-0672		
Air Secondary	7C-1062		
446B Backhoe Loader		5BL2500-UP	
Engine Oil	1R-0714		
Fuel Primary	117-4089		
Fuel Secondary	1R-0753		
Hydraulic	126-1817		
Power Train	119-4740		
Air Primary	108-0671		
Air Secondary	108-0672		
EXCAVATORS ^a			
205 Excavator		4DC1-UP	
Engine Oil	5W-5887		
Fuel Secondary	081-4662		
Hydraulic	8U-2805		
205B Excavator		5ZF1-UP	
Engine Oil	1R-0714		
Fuel Primary	9M-2341		
Fuel Secondary	1R-0750		
Hydraulic	8U-2805		
206 Excavator		3GC1-UP	
Engine Oil	5W-5887		
Fuel Secondary	081-4662		
Hydraulic	8U-2805		
206B Excavator		9BF1-UP	
Engine Oil	1R-0714		
Fuel Primary	9M-2341		
Fuel Secondary	1R-0750		
Hydraulic	8U-2805		
Air Primary	8T-7462		
Air Secondary	8T-7463		
211B Excavator		6XG1-UP	
Engine Oil	1R-0714		
Fuel Primary	9M-2341		
Fuel Secondary	1R-0750		
Hydraulic	8U-2805		
Air Primary	8T-7462		
Air Secondary	8T-7463		

FILTER TYPE	PART NUMBER	HIGH EFFICIENCY	FIRE RESISTANT
212 Excavator		5DC1-UP	
Engine Oil	081-4661		
Fuel Secondary	081-4662		
Hydraulic	8U-2805		
212B Excavator		3PJ1-UP	
Engine Oil	1R-0714		
Fuel Primary	9M-2341		
Fuel Secondary	1R-0750		
Hydraulic	8U-2805		
Air Primary	8T-7462		
Air Secondary	8T-7463		
213B Excavator		1EJ1-UP	
Engine Oil	1R-0739		
Fuel Primary	9M-2341		
Fuel Secondary	1R-0750		
Hydraulic	8U-2805		
Air Primary	8U-2601		
Air Secondary	8T-7463		
214B Excavator		4CF1-UP	
Engine Oil	1R-0739		
Fuel Primary	9M-2341		
Fuel Secondary	1R-0750		
Hydraulic	8U-2805		
Air Primary	5W-3402		
Air Primary	7E-0974		
Air Primary	8U-2601		
Air Secondary	8T-7463		
214B Excavator		9MF1-UP	
Engine Oil	1R-0739		
Fuel Primary	9M-2341		
Fuel Secondary	1R-0750		
Hydraulic	8U-2805		
Air Primary	5W-3402		
Air Primary	8T-7462		
Air Primary	8U-2601		
Air Secondary	7E-0974		
214BFT Excavator		4CF1-UP	
Engine Oil	1R-0739		
Fuel Primary	9M-2341		
Fuel Secondary	1R-0750		
Hydraulic	8U-2805		
Air Primary	5W-3402		
Air Primary	7E-0974		
Air Primary	8U-2601		
Air Secondary	8T-7463		
214BFT Excavator		9MF1-UP	
Engine Oil	1R-0739		
Fuel Primary	9M-2341		

a - For quantities, refer to parts book.

Filters - Excavators

FILTER TYPE	PART NUMBER	HIGH EFFICIENCY	FIRE RESISTANT
214BFT Excavator (cont.)			9MF1-UP
Fuel Secondary	1R-0750		
Hydraulic	8U-2805		
Air Primary	5W-3402		
Air Primary	8T-7462		
Air Primary	8U-2601		
Air Secondary	7E-0974		
215 Excavator			14Z1-UP
Engine Oil	1R-0714		
Fuel Primary	9M-2341		
Fuel Secondary	1R-0750		
Hydraulic	1R-0728	139-1532	4T-3130
Hydraulic	1R-0741	132-8876	4T-3132
Hydraulic	4T-6788	144-0832	
Air Primary	7W-5389		
Air Secondary	2S-1285		
215 Excavator			57Y1-UP
Engine Oil	1R-0714		
Fuel Primary	9M-2341		
Fuel Secondary	1R-0750		
Hydraulic	1R-0728	139-1532	4T-3130
Hydraulic	1R-0741	132-8876	4T-3132
Hydraulic	4T-6788	144-0832	
Air Primary	7W-5389		
Air Secondary	2S-1285		
215 Excavator			61Z1-UP
Engine Oil	1R-0714		
Fuel Primary	9M-2341		
Fuel Secondary	1R-0750		
Hydraulic	1R-0728	139-1532	4T-3130
Hydraulic	1R-0741	132-8876	4T-3132
Hydraulic	4T-6788	144-0832	
Air Primary	7W-5389		
Air Secondary	2S-1285		
215 Excavator			95Z1-UP
Engine Oil	1R-0739		
Fuel Primary	9M-2341		
Fuel Secondary	1R-0750		
Hydraulic	1R-0728	139-1532	4T-3130
Hydraulic	1R-0741	132-8876	4T-3132
Hydraulic	4T-6788	144-0832	
Air Primary	7W-5317		
Air Secondary	2S-1286		
215B Excavator			2XC1-UP
Engine Oil	1R-0714		
Fuel Primary	9M-2341		
Fuel Secondary	1R-0750		
Hydraulic	1R-0728	139-1532	4T-3130

FILTER TYPE	PART NUMBER	HIGH EFFICIENCY	FIRE RESISTANT
215B Excavator (cont.)			2XC1-UP
Hydraulic	1R-0741	132-8876	4T-3132
Hydraulic	4T-6788	144-0832	
Air Primary	7W-5389		
Air Secondary	2S-1285		
215B Excavator			9YB1-UP
Engine Oil	1R-0739		
Fuel Primary	9M-2341		
Fuel Secondary	1R-0750		
Hydraulic	1R-0728	139-1532	4T-3130
Hydraulic	1R-0741	132-8876	4T-3132
Hydraulic	4T-6788	144-0832	
Air Primary	7W-5317		
Air Secondary	2S-1286		
215B SA Excavator			4FC1-UP
Engine Oil	1R-0739		
Fuel Primary	9M-2341		
Fuel Secondary	1R-0750		
Hydraulic	1R-0728	139-1532	4T-3130
Hydraulic	1R-0741	132-8876	4T-3132
Hydraulic	4T-6788	144-0832	
Air Primary	7W-5317		
Air Secondary	2S-1286		
215C Excavator			4HG1-UP
Engine Oil	1R-0739		
Fuel Primary	9M-2341		
Fuel Secondary	1R-0750		
Hydraulic	1R-0728	139-1532	4T-3130
Hydraulic	1R-0741	132-8876	4T-3132
Hydraulic	4T-6788	144-0832	
Air Primary	7W-5317		
Air Secondary	2S-1286		
215C Excavator			5CF1-UP
Engine Oil	1R-0739		
Fuel Primary	9M-2341		
Fuel Secondary	1R-0750		
Hydraulic	1R-0728	139-1532	4T-3130
Hydraulic	1R-0741	132-8876	4T-3132
Hydraulic	4T-6788	144-0832	
Air Primary	7W-5317		
Air Secondary	2S-1286		
215D Excavator			9TF1-UP
Engine Oil	1R-0739		
Fuel Primary	9M-2341		
Fuel Secondary	1R-0750		
Hydraulic	1R-0728	139-1532	4T-3130
Hydraulic	1R-0741	132-8876	4T-3132
Hydraulic	4T-6788	144-0832	

a - For quantities, refer to parts book.

Filters - Excavators

FILTER TYPE	PART NUMBER	HIGH EFFICIENCY	FIRE RESISTANT
215D Excavator (cont.)			9TF1-UP
Air Primary	7W-5317		
Air Secondary	2S-1286		
219 Excavator			4HG1-UP
Engine Oil	1R-0739		
Fuel Primary	9M-2341		
Fuel Secondary	1R-0750		
Hydraulic	1R-0728	139-1532	4T-3130
Hydraulic	1R-0741	132-8876	4T-3132
Hydraulic	4T-6788	144-0832	
Air Primary	7W-5317		
Air Secondary	2S-1286		
219 Excavator			5CF1-UP
Engine Oil	1R-0739		
Fuel Primary	9M-2341		
Fuel Secondary	1R-0750		
Hydraulic	1R-0728	139-1532	4T-3130
Hydraulic	1R-0741	132-8876	4T-3132
Hydraulic	4T-6788	144-0832	
Air Primary	7W-5317		
Air Secondary	2S-1286		
219D Excavator			5XG1-UP
Engine Oil	1R-0739		
Fuel Primary	9M-2341		
Fuel Secondary	1R-0750		
Hydraulic	1R-0728	139-1532	4T-3130
Hydraulic	1R-0741	132-8876	4T-3132
Hydraulic	4T-6788	144-0832	
Air Primary	7W-5317		
Air Secondary	2S-1286		
224B Excavator			7WF1-UP
Engine Oil	1R-0739		
Fuel Primary	9M-2341		
Fuel Secondary	1R-0750		
Hydraulic	8U-2805		
Air Primary	8T-7462		
Air Primary	8U-2601		
225B Excavator			1AG1-UP
Engine Oil	1R-0739		
Fuel Primary	9M-2341		
Fuel Secondary	1R-0750		
Hydraulic	1R-0719	132-8875	4T-3131
Hydraulic	1R-0728	139-1532	4T-3130
Hydraulic	1R-0741	132-8876	4T-3132
Hydraulic	1R-0732	139-1535	4T-3133
Air Primary	7W-5317		
Air Secondary	2S-1286		

FILTER TYPE	PART NUMBER	HIGH EFFICIENCY	FIRE RESISTANT
225B Excavator			3YD1-UP
Engine Oil	1R-0739		
Fuel Primary	9M-2341		
Fuel Secondary	1R-0750		
Hydraulic	1R-0719	132-8875	4T-3131
Hydraulic	1R-0728	139-1532	4T-3130
Hydraulic	1R-0741	132-8876	4T-3132
Hydraulic	1R-0732	139-1535	4T-3133
Air Primary	7W-5317		
Air Secondary	2S-1286		
225B LC Excavator			1GF1-UP
Engine Oil	1R-0713		
Fuel Primary	8N-9803		
Fuel Secondary	1R-0750		
Hydraulic	1R-0719	132-8875	4T-3131
Hydraulic	1R-0728	139-1532	4T-3130
Hydraulic	1R-0732	139-1535	4T-3133
Air Primary	7W-5317		
Air Secondary	2S-1286		
225B LC Excavator			2ZD1-UP
Engine Oil	1R-0713		
Fuel Primary	8N-9803		
Fuel Secondary	1R-0750		
Hydraulic	1R-0719	132-8875	4T-3131
Hydraulic	1R-0728	139-1532	4T-3130
Hydraulic	1R-0732	139-1535	4T-3133
Air Primary	7W-5317		
Air Secondary	2S-1286		
225D Excavator			2SJ1-UP
Engine Oil	1R-0713		
Fuel Primary	8N-9803		
Fuel Secondary	1R-0750		
Hydraulic	1R-0719	132-8875	4T-3131
Hydraulic	1R-0728	139-1532	4T-3130
Hydraulic	1R-0741	132-8876	4T-3132
Hydraulic	1R-0732	139-1535	4T-3133
Air Primary	7W-5316		
Air Secondary	2S-1287		
225D LC Excavator			6RG1-UP
Engine Oil	1R-0739		
Fuel Primary	9M-2341		
Fuel Secondary	1R-0750		
Hydraulic	1R-0719	132-8875	4T-3131
Hydraulic	1R-0728	139-1532	4T-3130
Hydraulic	1R-0741	132-8876	4T-3132
Hydraulic	1R-0732	139-1535	4T-3133
Air Primary	7W-5317		
Air Secondary	2S-1286		

a - For quantities, refer to parts book.

Filters - Excavators

FILTER TYPE	PART NUMBER	HIGH EFFICIENCY	FIRE RESISTANT
229 Excavator			1AG1-UP
Engine Oil	1R-0739		
Fuel Primary	9M-2341		
Fuel Secondary	1R-0750		
Hydraulic	1R-0719	132-8875	4T-3131
Hydraulic	1R-0728	139-1532	4T-3130
Hydraulic	1R-0741	132-8876	4T-3132
Hydraulic	1R-0732	139-1535	4T-3133
Air Primary	7W-5317		
Air Secondary	2S-1286		
229 Excavator			1GF1-UP
Engine Oil	1R-0713		
Fuel Primary	8N-9803		
Fuel Secondary	1R-0750		
Hydraulic	1R-0719	132-8875	4T-3131
Hydraulic	1R-0728	139-1532	4T-3130
Hydraulic	1R-0732	139-1535	4T-3133
Air Primary	7W-5317		
Air Secondary	2S-1286		
229 Excavator			2ZD1-UP
Engine Oil	1R-0713		
Fuel Primary	8N-9803		
Fuel Secondary	1R-0750		
Hydraulic	1R-0719	132-8875	4T-3131
Hydraulic	1R-0728	139-1532	4T-3130
Hydraulic	1R-0732	139-1535	4T-3133
Air Primary	7W-5317		
Air Secondary	2S-1286		
229 Excavator			3YD1-UP
Engine Oil	1R-0739		
Fuel Primary	9M-2341		
Fuel Secondary	1R-0750		
Hydraulic	1R-0719	132-8875	4T-3131
Hydraulic	1R-0728	139-1532	4T-3130
Hydraulic	1R-0741	132-8876	4T-3132
Hydraulic	1R-0732	139-1535	4T-3133
Air Primary	7W-5317		
Air Secondary	2S-1286		
229D Excavator			2LJ1-UP
Engine Oil	1R-0739		
Fuel Primary	9M-2341		
Fuel Secondary	1R-0750		
Hydraulic	1R-0719	132-8875	4T-3131
Hydraulic	1R-0728	139-1532	4T-3130
Hydraulic	1R-0741	132-8876	4T-3132
Hydraulic	1R-0732	139-1535	4T-3133
Air Primary	7W-5317		
Air Secondary	2S-1286		

FILTER TYPE	PART NUMBER	HIGH EFFICIENCY	FIRE RESISTANT
231D Excavator			1NK1-UP
Engine Oil	1R-0714		
Fuel Primary	8N-9803		
Fuel Secondary	1R-0750		
Hydraulic	1R-0719	132-8875	4T-3131
Hydraulic	1R-0728	139-1532	4T-3130
Hydraulic	1R-0741	132-8876	4T-3132
Hydraulic	1R-0732	139-1535	4T-3133
Air Primary	7W-5316		
Air Secondary	2S-1287		
231D Excavator			5WJ1-UP
Engine Oil	1R-0714		
Fuel Primary	8N-9803		
Fuel Secondary	1R-0750		
Hydraulic	1R-0719	132-8875	4T-3131
Hydraulic	1R-0728	139-1532	4T-3130
Hydraulic	1R-0741	132-8876	4T-3132
Hydraulic	1R-0732	139-1535	4T-3133
Air Primary	7W-5316		
Air Secondary	2S-1287		
231D LC Excavator			5WJ1-UP
Engine Oil	1R-0714		
Fuel Primary	8N-9803		
Fuel Secondary	1R-0750		
Hydraulic	1R-0719	132-8875	4T-3131
Hydraulic	1R-0728	139-1532	4T-3130
Hydraulic	1R-0741	132-8876	4T-3132
Hydraulic	1R-0732	139-1535	4T-3133
Air Primary	7W-5316		
Air Secondary	2S-1287		
235B Excavator			1FD1-UP
Engine Oil	1R-0739		
Fuel Primary	9M-2341		
Fuel Secondary	1R-0750		
Hydraulic	1R-0719	132-8875	4T-3131
Hydraulic	1R-0728	139-1532	4T-3130
Hydraulic	1R-0732	139-1535	4T-3133
Air Primary	7W-5316		
Air Secondary	2S-1287		
235B Excavator			4ED1-UP
Engine Oil	1R-0739		
Fuel Primary	9M-2341		
Fuel Secondary	1R-0750		
Hydraulic	1R-0719	132-8875	4T-3131
Hydraulic	1R-0728	139-1532	4T-3130
Hydraulic	1R-0741	132-8876	4T-3132
Hydraulic	1R-0732	139-1535	4T-3133
Air Primary	7W-5316		

a - For quantities, refer to parts book.

Filters - Excavators

FILTER TYPE	PART NUMBER	HIGH EFFICIENCY	FIRE RESISTANT
235B Excavator (cont.)			4ED1-UP
Air Secondary	2S-1287		
235B Excavator			7WC1-UP
Engine Oil	1R-0739		
Fuel Primary	9M-2341		
Fuel Secondary	1R-0750		
Hydraulic	1R-0719	132-8875	4T-3131
Hydraulic	1R-0728	139-1532	4T-3130
Hydraulic	1R-0732	139-1535	4T-3133
Air Primary	7W-5316		
Air Secondary	2S-1287		
235B Excavator			9PC1-UP
Engine Oil	1R-0739		
Fuel Primary	9M-2341		
Fuel Secondary	1R-0750		
Hydraulic	1R-0719	132-8875	4T-3131
Hydraulic	1R-0728	139-1532	4T-3130
Hydraulic	1R-0741	132-8876	4T-3132
Hydraulic	1R-0732	139-1535	4T-3133
Air Primary	7W-5316		
Air Secondary	2S-1287		
235C Excavator			2PG1-UP
Engine Oil	1R-0739		
Fuel Primary	9M-2341		
Fuel Secondary	1R-0750		
Hydraulic	1R-0719	132-8875	4T-3131
Hydraulic	1R-0728	139-1532	4T-3130
Hydraulic	1R-0741	132-8876	4T-3132
Hydraulic	1R-0732	139-1535	4T-3133
Air Primary	7W-5316		
Air Secondary	2S-1287		
235C Excavator			3WG1-UP
Engine Oil	1R-0739		
Fuel Primary	9M-2341		
Fuel Secondary	1R-0750		
Hydraulic	1R-0719	132-8875	4T-3131
Hydraulic	1R-0728	139-1532	4T-3130
Hydraulic	1R-0732	139-1535	4T-3133
Air Primary	7W-5316		
Air Secondary	2S-1287		
235C Excavator			4DG1-UP
Engine Oil	1R-0739		
Fuel Primary	9M-2341		
Fuel Secondary	1R-0750		
Hydraulic	1R-0719	132-8875	4T-3131
Hydraulic	1R-0728	139-1532	4T-3130
Hydraulic	1R-0741	132-8876	4T-3132
Hydraulic	1R-0732	139-1535	4T-3133

FILTER TYPE	PART NUMBER	HIGH EFFICIENCY	FIRE RESISTANT
235C Excavator (cont.)			4DG1-UP
Air Primary	7W-5316		
Air Secondary	2S-1287		
235C Excavator			5AF1-UP
Engine Oil	1R-0739		
Fuel Primary	9M-2341		
Fuel Secondary	1R-0750		
Hydraulic	1R-0719	132-8875	4T-3131
Hydraulic	1R-0728	139-1532	4T-3130
Hydraulic	1R-0732	139-1535	4T-3133
Air Primary	6I-2501		
Air Primary	6I-2503		
Air Primary	7W-5316		
Air Secondary	2S-1287		
Air Secondary	6I-2502		
Air Secondary	6I-2504		
235D Excavator			8KJ1-UP
Engine Oil	1R-0739		
Fuel Primary	9M-2341		
Fuel Secondary	1R-0750		
Hydraulic	1R-0719	132-8875	4T-3131
Hydraulic	1R-0728	139-1532	4T-3130
Hydraulic	1R-0732	139-1535	4T-3133
Air Primary	7W-5316		
Air Secondary	2S-1287		
235D Excavator			8TJ1-UP
Engine Oil	1R-0739		
Fuel Primary	9M-2341		
Fuel Secondary	1R-0750		
Hydraulic	1R-0719	132-8875	4T-3131
Hydraulic	1R-0728	139-1532	4T-3130
Hydraulic	1R-0732	139-1535	4T-3133
Hydraulic	1R-0741	132-8876	4T-3132
Air Primary	7W-5316		
Air Secondary	2S-1287		
245B Excavator			1SJ1-712
Engine Oil	1W-8845		
Engine Oil	1R-0716		
Fuel Primary	9M-2341		
Fuel Secondary	1R-0749		
Hydraulic	1R-0728	139-1532	4T-3130
Hydraulic	1R-0732	139-1535	4T-3133
Air Primary	7W-5313		
Air Secondary	1P-8482		
245B Excavator			6MF1-512
Engine Oil	1R-0716		
Engine Oil	1W-8845		
Fuel Primary	9M-2341		

a - For quantities, refer to parts book.

Filters - Excavators

FILTER TYPE	PART NUMBER	HIGH EFFICIENCY	FIRE RESISTANT
245B Excavator (cont.)		6MF1-512	
Fuel Secondary	1R-0749		
Hydraulic	1R-0728	139-1532	4T-3130
Hydraulic	1R-0732	139-1535	4T-3133
Air Primary	6I-2505		
Air Primary	7W-5313		
Air Secondary	1P-8482		
Air Secondary	6I-2506		
245B Series II Excavator		1SJ713-UP	
Engine Oil	1W-8845		
Engine Oil	1R-0716		
Fuel Primary	9M-2341		
Fuel Secondary	1R-0749		
Hydraulic	1R-0728	139-1532	4T-3130
Hydraulic	1R-0732	139-1535	4T-3133
Air Primary	7W-5313		
Air Secondary	1P-8482		
245B Series II Excavator		6MF513-UP	
Engine Oil	1R-0716		
Engine Oil	1W-8845		
Fuel Primary	9M-2341		
Fuel Secondary	1R-0749		
Hydraulic	1R-0728	139-1532	4T-3130
Hydraulic	1R-0732	139-1535	4T-3133
Air Primary	7W-5313		
Air Secondary	1P-8482		
245D Excavator		4LK1-UP	
Engine Oil	1R-0716		
Engine Oil	1W-8845		
Fuel Primary	9M-2341		
Fuel Secondary	1R-0749		
Hydraulic	1R-0728	139-1532	4T-3130
Hydraulic	1R-0732	139-1535	4T-3133
Air Primary	7W-5313		
Air Secondary	1P-8482		
245D Excavator		7ZJ1-UP	
Engine Oil	1W-8845		
Engine Oil	1R-0716		
Fuel Primary	9M-2341		
Fuel Secondary	1R-0749		
Hydraulic	1R-0728	139-1532	4T-3130
Hydraulic	1R-0732	139-1535	4T-3133
Air Primary	7W-5313		
Air Secondary	1P-8482		
301.5 Excavator		3YW1-UP	
Engine Oil	150-4140		
Engine Oil	1R-0734		
Fuel Secondary	156-1200		

FILTER TYPE	PART NUMBER	HIGH EFFICIENCY	FIRE RESISTANT
301.5 Excavator (cont.)		3YW1-UP	
Power Train	149-4533		
Power Train	1G-8878	102-2828	156-0214
Air Primary	146-7472		
301.5 Excavator		BDH1-UP	
Engine Oil	1R-0734		
Fuel Secondary	156-1200		
Hydraulic	149-4533		
Air Primary	146-7472		
301.5 Excavator		BFA1-UP	
Engine Oil	1R-0734		
Fuel Secondary	156-1200		
Hydraulic	149-4533		
Air Primary	146-7472		
301.6 Excavator		3YW1-UP	
Engine Oil	150-4140		
Engine Oil	1R-0734		
Fuel Secondary	156-1200		
Power Train	149-4533		
Power Train	1G-8878	102-2828	156-0214
Air Primary	146-7472		
301.6 Excavator		BDH1-UP	
Engine Oil	1R-0734		
Fuel Secondary	156-1200		
Hydraulic	149-4533		
Air Primary	146-7472		
301.6 Excavator		BFA1-UP	
Engine Oil	1R-0734		
Fuel Secondary	156-1200		
Hydraulic	149-4533		
Air Primary	146-7472		
301.8 Excavator		3YW1-UP	
Engine Oil	150-4140		
Engine Oil	1R-0734		
Fuel Secondary	156-1200		
Power Train	149-4533		
Power Train	1G-8878	102-2828	156-0214
Air Primary	146-7472		
301.8 Excavator		BDH1-UP	
Engine Oil	1R-0734		
Fuel Secondary	156-1200		
Hydraulic	149-4533		
Air Primary	146-7472		
301.8 Excavator		BFA1-UP	
Engine Oil	1R-0734		
Fuel Secondary	156-1200		
Hydraulic	149-4533		
Air Primary	146-7472		

a - For quantities, refer to parts book.

Filters - Excavators

FILTER TYPE	PART NUMBER	HIGH EFFICIENCY	FIRE RESISTANT
302.5 Excavator			4AZ1-UP
Engine Oil	150-4140		
Fuel Secondary	156-1200		
Hydraulic	9T-8578	144-0832	
Power Train	9T-8578	144-0832	
Air Primary	146-7472		
Air Secondary	146-7473		
303.5 Excavator			AFW1-UP
Engine Oil	150-4140		
Fuel Secondary	156-1200		
Hydraulic	143-0588		
Hydraulic	149-5411		
Air Primary	146-7472		
Air Secondary	146-7473		
304.5 Excavator			ANR1-UP
Engine Oil	150-4140		
Fuel Secondary	156-1200		
Hydraulic	143-0588		
Hydraulic	149-5411		
Air Primary	146-7472		
Air Secondary	146-7473		
307 Excavator			2PM1-UP
Engine Oil	094-7207		
Engine Oil	094-7208		
Hydraulic	093-5369		
Hydraulic	5I-8670		
Air Primary	109-9300		
307 Excavator			2WM1-UP
Engine Oil	7W-2327		
Fuel Primary	138-3100		
Fuel Secondary	159-6102		
Hydraulic	093-5369		
Hydraulic	5I-8670		
Air Primary	110-6326		
Air Secondary	110-6331		
307B Excavator			4RW1-UP
Fuel Secondary	183-8187		
Hydraulic	093-5369		
Hydraulic	5I-8670		
Air Primary	134-8726		
307B Excavator			5CW1-UP
Fuel Secondary	183-8187		
Hydraulic	093-5369		
Hydraulic	5I-8670		
Air Primary	134-8726		
307B Excavator			6KZ1-UP
Fuel Secondary	183-8187		
Hydraulic	093-5369		

FILTER TYPE	PART NUMBER	HIGH EFFICIENCY	FIRE RESISTANT
307B Excavator (cont.)			6KZ1-UP
Hydraulic	5I-8670		
Air Primary	134-8726		
307B Excavator			7DZ1-UP
Fuel Secondary	183-8187		
Hydraulic	093-5369		
Hydraulic	5I-8670		
Air Primary	134-8726		
307B Excavator			AFB1-UP
Fuel Secondary	183-8187		
Hydraulic	093-5369		
Hydraulic	5I-8670		
Air Primary	134-8726		
Air Secondary	140-2334		
307C Excavator			BCM1-UP
Engine Oil	1R-0714		
Fuel Secondary	183-8187		
Hydraulic	093-5369		
Hydraulic	5I-8670		
Air Primary	134-8726		
307C Excavator			BNE1-UP
Engine Oil	1R-0714		
Fuel Secondary	183-8187		
Hydraulic	093-5369		
Hydraulic	5I-8670		
Air Primary	134-8726		
311 Excavator			9LJ1-UP
Engine Oil	1R-0739		
Engine Oil	5I-7950		
Fuel Secondary	5I-7951		
Hydraulic	094-3229	139-1539	
Hydraulic	5I-8670		
Air Primary	4I-7575		
Air Secondary	6I-6582		
311B Excavator			2LS1-UP
Engine Oil	1R-0739		
Fuel Secondary	5I-7951		
Fuel Secondary	5I-7951		
Hydraulic	093-7521		
Hydraulic	126-2081	126-2131	
Hydraulic	5I-8670		
Air Primary	131-8902		
Air Secondary	131-8903		
311B Excavator			8GR1-UP
Engine Oil	1R-0739		
Fuel Secondary	5I-7951		
Fuel Secondary	5I-7951		
Hydraulic	093-7521		

a - For quantities, refer to parts book.

Filters - Excavators

FILTER TYPE	PART NUMBER	HIGH EFFICIENCY	FIRE RESISTANT
311B Excavator (cont.)			8GR1-UP
Hydraulic	126-2081	126-2131	
Hydraulic	51-8670		
Air Primary	131-8902		
Air Secondary	131-8903		
311CU Excavator			CKE1-UP
Engine Oil	1R-0739		
Fuel Primary	117-4089		
Hydraulic	093-7521		
Hydraulic	126-2081	126-2131	
Hydraulic	51-8670		
Air Primary	108-0671		
Air Primary	131-8902		
Air Secondary	108-0672		
Air Secondary	131-8903		
312 Excavator			6BL1-UP
Engine Oil	7W-2326		
Fuel Primary	138-3100		
Fuel Secondary	159-6102		
Hydraulic	094-3229	139-1539	
Hydraulic	51-8670		
Air Primary	110-6326		
Air Secondary	110-6331		
312 Excavator			6GK1-UP
Engine Oil	1R-0739		
Engine Oil	5I-7950		
Fuel Secondary	5I-7951		
Hydraulic	094-3229	139-1539	
Hydraulic	51-8670		
Air Primary	4I-7575		
Air Secondary	6I-6582		
312B Excavator			2KW1-UP
Engine Oil	7W-2326		
Fuel Primary	138-3100		
Fuel Secondary	159-6102		
Hydraulic	093-7521		
Hydraulic	126-2081	126-2131	
Hydraulic	51-8670		
Air Primary	110-6326		
Air Secondary	110-6331		
312B Excavator			2NS1-UP
Engine Oil	1R-0739		
Fuel Secondary	5I-7951		
Hydraulic	093-7521		
Hydraulic	126-2081	126-2131	
Hydraulic	51-8670		
Air Primary	131-8902		
Air Secondary	131-8903		

FILTER TYPE	PART NUMBER	HIGH EFFICIENCY	FIRE RESISTANT
312B Excavator			3FS1-UP
Engine Oil	1R-0739		
Fuel Secondary	5I-7951		
Hydraulic	093-7521		
Hydraulic	126-2081	126-2131	
Hydraulic	51-8670		
Air Primary	131-8902		
Air Secondary	131-8903		
312B Excavator			6SW1-UP
Engine Oil	7W-2326		
Fuel Primary	138-3100		
Fuel Secondary	159-6102		
Hydraulic	093-7521		
Hydraulic	126-2081	126-2131	
Hydraulic	51-8670		
Air Primary	110-6326		
Air Secondary	110-6331		
312B Excavator			8JR1-UP
Engine Oil	1R-0739		
Fuel Secondary	5I-7951		
Hydraulic	093-7521		
Hydraulic	126-2081	126-2131	
Hydraulic	51-8670		
Air Primary	131-8902		
Air Secondary	131-8903		
312B Excavator			9FS1-UP
Engine Oil	7W-2326		
Fuel Primary	138-3100		
Fuel Secondary	159-6102		
Hydraulic	093-7521		
Hydraulic	126-2081	126-2131	
Hydraulic	51-8670		
Air Primary	110-6326		
Air Secondary	110-6331		
312B Excavator			9GR1-UP
Engine Oil	1R-0739		
Fuel Secondary	5I-7951		
Hydraulic	093-7521		
Hydraulic	126-2081	126-2131	
Hydraulic	51-8670		
Air Primary	131-8902		
Air Secondary	131-8903		
312B Excavator			9NW1-UP
Engine Oil	7W-2326		
Fuel Primary	138-3100		
Fuel Secondary	159-6102		
Hydraulic	093-7521		
Hydraulic	126-2081	126-2131	

a - For quantities, refer to parts book.

Filters - Excavators

FILTER TYPE	PART NUMBER	HIGH EFFICIENCY	FIRE RESISTANT
312B Excavator (cont.)			9NW1-UP
Hydraulic	5I-8670		
Air Primary	110-6326		
Air Secondary	110-6331		
312B L Excavator			2KW1-UP
Engine Oil	7W-2326		
Fuel Primary	138-3100		
Fuel Secondary	159-6102		
Hydraulic	093-7521		
Hydraulic	126-2081	126-2131	
Hydraulic	5I-8670		
Air Primary	110-6326		
Air Secondary	110-6331		
312B L Excavator			2NS1-UP
Engine Oil	1R-0739		
Fuel Secondary	5I-7951		
Hydraulic	093-7521		
Hydraulic	126-2081	126-2131	
Hydraulic	5I-8670		
Air Primary	131-8902		
Air Secondary	131-8903		
312B L Excavator			3FS1-UP
Engine Oil	1R-0739		
Fuel Secondary	5I-7951		
Hydraulic	093-7521		
Hydraulic	126-2081	126-2131	
Hydraulic	5I-8670		
Air Primary	131-8902		
Air Secondary	131-8903		
312B L Excavator			6SW1-UP
Engine Oil	7W-2326		
Fuel Primary	138-3100		
Fuel Secondary	159-6102		
Hydraulic	093-7521		
Hydraulic	126-2081	126-2131	
Hydraulic	5I-8670		
Air Primary	110-6326		
Air Secondary	110-6331		
312B L Excavator			8JR1-UP
Engine Oil	1R-0739		
Fuel Secondary	5I-7951		
Hydraulic	093-7521		
Hydraulic	126-2081	126-2131	
Hydraulic	5I-8670		
Air Primary	131-8902		
Air Secondary	131-8903		
312B L Excavator			9FS1-UP
Engine Oil	7W-2326		

FILTER TYPE	PART NUMBER	HIGH EFFICIENCY	FIRE RESISTANT
312B L Excavator (cont.)			9FS1-UP
Fuel Primary	138-3100		
Fuel Secondary	159-6102		
Hydraulic	093-7521		
Hydraulic	126-2081	126-2131	
Hydraulic	5I-8670		
Air Primary	110-6326		
Air Secondary	110-6331		
312B L Excavator			9GR1-UP
Engine Oil	1R-0739		
Fuel Secondary	5I-7951		
Hydraulic	093-7521		
Hydraulic	126-2081	126-2131	
Hydraulic	5I-8670		
Air Primary	131-8902		
Air Secondary	131-8903		
312B L Excavator			9NW1-UP
Engine Oil	7W-2326		
Fuel Primary	138-3100		
Fuel Secondary	159-6102		
Hydraulic	093-7521		
Hydraulic	126-2081	126-2131	
Hydraulic	5I-8670		
Air Primary	110-6326		
Air Secondary	110-6331		
312C Excavator			BNN1-UP
Engine Oil	7W-2326		
Fuel Primary	117-4089		
Fuel Secondary	159-6102		
Hydraulic	093-7521		
Hydraulic	126-2081	126-2131	
Hydraulic	5I-8670		
Air Primary	110-6326		
Air Secondary	110-6331		
312C Excavator			CBA1-UP
Engine Oil	1R-0739		
Fuel Primary	117-4089		
Fuel Secondary	1R-0751		
Hydraulic	093-7521		
Hydraulic	126-2081	126-2131	
Hydraulic	5I-8670		
Air Primary	108-0671		
Air Primary	131-8902		
Air Secondary	108-0672		
Air Secondary	131-8903		
312C Excavator			CBT1-UP
Engine Oil	7W-2326		
Fuel Primary	117-4089		

a - For quantities, refer to parts book.

Filters - Excavators

FILTER TYPE	PART NUMBER	HIGH EFFICIENCY	FIRE RESISTANT
312C Excavator (cont.)			CBT1-UP
Fuel Secondary	159-6102		
Hydraulic	093-7521		
Hydraulic	126-2081	126-2131	
Hydraulic	5I-8670		
Air Primary	110-6326		
Air Secondary	110-6331		
312C Excavator			FDS1-UP
Engine Oil	1R-0739		
Fuel Primary	117-4089		
Fuel Secondary	1R-0751		
Hydraulic	093-7521		
Hydraulic	126-2081	126-2131	
Hydraulic	5I-8670		
Air Primary	108-0671		
Air Primary	131-8902		
Air Secondary	108-0672		
Air Secondary	131-8903		
312C L Excavator			BNN1-UP
Engine Oil	7W-2326		
Fuel Primary	117-4089		
Fuel Secondary	159-6102		
Hydraulic	093-7521		
Hydraulic	126-2081	126-2131	
Hydraulic	5I-8670		
Air Primary	110-6326		
Air Secondary	110-6331		
312C L Excavator			CBA1-UP
Engine Oil	1R-0739		
Fuel Primary	117-4089		
Fuel Secondary	1R-0751		
Hydraulic	093-7521		
Hydraulic	126-2081	126-2131	
Hydraulic	5I-8670		
Air Primary	108-0671		
Air Primary	131-8902		
Air Secondary	108-0672		
Air Secondary	131-8903		
312C L Excavator			CBT1-UP
Engine Oil	7W-2326		
Fuel Primary	117-4089		
Fuel Secondary	159-6102		
Hydraulic	093-7521		
Hydraulic	126-2081	126-2131	
Hydraulic	5I-8670		
Air Primary	110-6326		
Air Secondary	110-6331		

FILTER TYPE	PART NUMBER	HIGH EFFICIENCY	FIRE RESISTANT
312C L Excavator			FDS1-UP
Engine Oil	1R-0739		
Fuel Primary	117-4089		
Fuel Secondary	1R-0751		
Hydraulic	093-7521		
Hydraulic	126-2081	126-2131	
Hydraulic	5I-8670		
Air Primary	108-0671		
Air Primary	131-8902		
Air Secondary	108-0672		
Air Secondary	131-8903		
313B CR Excavator			BAS1-UP
Engine Oil	172-9662		
Fuel Secondary	183-8187		
Hydraulic	094-3229	139-1539	
Hydraulic	5I-8670		
Air Primary	6I-6434		
315 Excavator			3ZM1-UP
Engine Oil	7W-2326		
Fuel Primary	138-3100		
Fuel Secondary	159-6102		
Hydraulic	094-3229	139-1539	
Hydraulic	5I-8670		
Air Primary	110-6326		
Air Secondary	110-6331		
315B Excavator			5SW1-UP
Engine Oil	7W-2326		
Fuel Primary	138-3100		
Fuel Secondary	159-6102		
Hydraulic	093-7521		
Hydraulic	126-2081	126-2131	
Hydraulic	5I-8670		
Air Primary	110-6326		
Air Secondary	110-6331		
315B Excavator			1SW1-UP
Engine Oil	1R-0734		
Fuel Primary	118-5768		
Fuel Secondary	5I-7951		
Hydraulic	093-7521		
Hydraulic	126-2081	126-2131	
Hydraulic	5I-8670		
Air Primary	135-5788		
Air Secondary	135-5787		
315B Excavator			3AW1-UP
Engine Oil	1R-0734		
Fuel Primary	118-5768		
Fuel Secondary	5I-7951		
Hydraulic	093-7521		

a - For quantities, refer to parts book.

Filters - Excavators

FILTER TYPE	PART NUMBER	HIGH EFFICIENCY	FIRE RESISTANT
315B Excavator (cont.)			3AW1-UP
Hydraulic	126-2081	126-2131	
Hydraulic	5I-8670		
Air Primary	135-5788		
Air Secondary	135-5787		
315B L Excavator			1SW1-UP
Engine Oil	1R-0734		
Fuel Primary	118-5768		
Fuel Secondary	5I-7951		
Hydraulic	093-7521		
Hydraulic	126-2081	126-2131	
Hydraulic	5I-8670		
Air Primary	135-5788		
Air Secondary	135-5787		
315B L Excavator			3AW1-UP
Engine Oil	1R-0734		
Fuel Primary	118-5768		
Fuel Secondary	5I-7951		
Hydraulic	093-7521		
Hydraulic	126-2081	126-2131	
Hydraulic	5I-8670		
Air Primary	135-5788		
Air Secondary	135-5787		
315C Excavator			CFB1-UP
Engine Oil	1R-0739		
Fuel Primary	117-4089		
Fuel Primary	118-5768		
Fuel Secondary	1R-0751		
Hydraulic	093-7521		
Hydraulic	126-2081	126-2131	
Hydraulic	5I-8670		
Air Primary	135-5788		
Air Primary	152-7217		
Air Secondary	135-5787		
Air Secondary	152-7219		
315C Excavator			CFT1-UP
Engine Oil	1R-0739		
Fuel Primary	117-4089		
Fuel Primary	118-5768		
Fuel Secondary	1R-0751		
Hydraulic	093-7521		
Hydraulic	126-2081	126-2131	
Hydraulic	5I-8670		
Air Primary	135-5788		
Air Primary	152-7217		
Air Secondary	135-5787		
Air Secondary	152-7219		

FILTER TYPE	PART NUMBER	HIGH EFFICIENCY	FIRE RESISTANT
315C L Excavator			CFB1-UP
Engine Oil	1R-0739		
Fuel Primary	117-4089		
Fuel Primary	118-5768		
Fuel Secondary	1R-0751		
Hydraulic	093-7521		
Hydraulic	126-2081	126-2131	
Hydraulic	5I-8670		
Air Primary	135-5788		
Air Primary	152-7217		
Air Secondary	135-5787		
Air Secondary	152-7219		
315C L Excavator			CFT1-UP
Engine Oil	1R-0739		
Fuel Primary	117-4089		
Fuel Primary	118-5768		
Fuel Secondary	1R-0751		
Hydraulic	093-7521		
Hydraulic	126-2081	126-2131	
Hydraulic	5I-8670		
Air Primary	135-5788		
Air Primary	152-7217		
Air Secondary	135-5787		
Air Secondary	152-7219		
315L Excavator			4YM1-UP
Engine Oil	1R-0734		
Fuel Primary	118-5768		
Fuel Secondary	5I-7951		
Hydraulic	094-3229	139-1539	
Hydraulic	5I-8670		
Air Primary	4I-7575		
Air Secondary	6I-6582		
315L Excavator			6YM1-UP
Engine Oil	1R-0734		
Fuel Primary	118-5768		
Fuel Secondary	5I-7951		
Hydraulic	094-3229	139-1539	
Hydraulic	5I-8670		
Air Primary	4I-7575		
Air Secondary	6I-6582		
317 Excavator			4MM1-UP
Engine Oil	7W-2326		
Fuel Primary	138-3100		
Fuel Secondary	159-6102		
Hydraulic	094-3229	139-1539	
Hydraulic	5I-8670		
Air Primary	110-6326		
Air Secondary	110-6331		

a - For quantities, refer to parts book.

Filters - Excavators

FILTER TYPE	PART NUMBER	HIGH EFFICIENCY	FIRE RESISTANT
317 Excavator			9SR1-UP
Engine Oil	7W-2326		
Fuel Primary	138-3100		
Fuel Secondary	159-6102		
Hydraulic	094-3229	139-1539	
Hydraulic	5I-8670		
Air Primary	110-6326		
Air Secondary	110-6331		
317B L Excavator			6DZ1-UP
Engine Oil	1R-0734		
Fuel Primary	118-5768		
Fuel Secondary	5I-7951		
Hydraulic	093-7521		
Hydraulic	126-2081	126-2131	
Hydraulic	5I-8670		
Air Primary	135-5788		
Air Secondary	135-5787		
317B L Excavator			9WW1-UP
Engine Oil	1R-0734		
Fuel Primary	118-5768		
Fuel Secondary	5I-7951		
Hydraulic	093-7521		
Hydraulic	126-2081	126-2131	
Hydraulic	5I-8670		
Air Primary	135-5788		
Air Secondary	135-5787		
317B LN Excavator			6DZ1-UP
Engine Oil	1R-0734		
Fuel Primary	118-5768		
Fuel Secondary	5I-7951		
Hydraulic	093-7521		
Hydraulic	126-2081	126-2131	
Hydraulic	5I-8670		
Air Primary	135-5788		
Air Secondary	135-5787		
317B LN Excavator			9WW1-UP
Engine Oil	1R-0734		
Fuel Primary	118-5768		
Fuel Secondary	5I-7951		
Hydraulic	093-7521		
Hydraulic	126-2081	126-2131	
Hydraulic	5I-8670		
Air Primary	135-5788		
Air Secondary	135-5787		
317N Excavator			4MM1-UP
Engine Oil	7W-2326		
Fuel Primary	138-3100		
Fuel Secondary	159-6102		

FILTER TYPE	PART NUMBER	HIGH EFFICIENCY	FIRE RESISTANT
317N Excavator (cont.)			4MM1-UP
Hydraulic	094-3229	139-1539	
Hydraulic	5I-8670		
Air Primary	110-6326		
Air Secondary	110-6331		
317N Excavator			9SR1-UP
Engine Oil	7W-2326		
Fuel Primary	138-3100		
Fuel Secondary	159-6102		
Hydraulic	094-3229	139-1539	
Hydraulic	5I-8670		
Air Primary	110-6326		
Air Secondary	110-6331		
318B L Excavator			3LR1-UP
Engine Oil	1R-0734		
Fuel Primary	118-5768		
Fuel Secondary	5I-7951		
Hydraulic	093-7521		
Hydraulic	126-2081	126-2131	
Hydraulic	5I-8670		
Air Primary	135-5788		
Air Secondary	135-5787		
318B L Excavator			7KZ1-UP
Engine Oil	1R-0734		
Fuel Primary	118-5768		
Fuel Secondary	5I-7951		
Hydraulic	093-7521		
Hydraulic	126-2081	126-2131	
Hydraulic	5I-8670		
Air Primary	135-5788		
Air Secondary	135-5787		
318B L Excavator			ADC1-UP
Engine Oil	1R-0734		
Fuel Primary	118-5768		
Fuel Secondary	5I-7951		
Hydraulic	093-7521		
Hydraulic	126-2081	126-2131	
Hydraulic	5I-8670		
Air Primary	135-5788		
Air Secondary	135-5787		
318B L Excavator			AEJ1-UP
Engine Oil	1R-0734		
Fuel Primary	118-5768		
Fuel Secondary	5I-7951		
Hydraulic	093-7521		
Hydraulic	126-2081	126-2131	
Hydraulic	5I-8670		
Air Primary	135-5788		

a - For quantities, refer to parts book.

Filters - Excavators

FILTER TYPE	PART NUMBER	HIGH EFFICIENCY	FIRE RESISTANT
318B L Excavator (cont.)			AEJ1-UP
Air Secondary	135-5787		
318B LN Excavator			3LR1-UP
Engine Oil	1R-0734		
Fuel Primary	118-5768		
Fuel Secondary	5I-7951		
Hydraulic	093-7521		
Hydraulic	126-2081	126-2131	
Hydraulic	5I-8670		
Air Primary	135-5788		
Air Secondary	135-5787		
318B LN Excavator			7KZ1-UP
Engine Oil	1R-0734		
Fuel Primary	118-5768		
Fuel Secondary	5I-7951		
Hydraulic	093-7521		
Hydraulic	126-2081	126-2131	
Hydraulic	5I-8670		
Air Primary	135-5788		
Air Secondary	135-5787		
318B LN Excavator			ADC1-UP
Engine Oil	1R-0734		
Fuel Primary	118-5768		
Fuel Secondary	5I-7951		
Hydraulic	093-7521		
Hydraulic	126-2081	126-2131	
Hydraulic	5I-8670		
Air Primary	135-5788		
Air Secondary	135-5787		
318B LN Excavator			AEJ1-UP
Engine Oil	1R-0734		
Fuel Primary	118-5768		
Fuel Secondary	5I-7951		
Hydraulic	093-7521		
Hydraulic	126-2081	126-2131	
Hydraulic	5I-8670		
Air Primary	135-5788		
Air Secondary	135-5787		
320 Excavator			1KL1-UP
Engine Oil	1R-0739		
Engine Oil	5I-7950		
Fuel Secondary	5I-7951		
Hydraulic	093-7521		
Hydraulic	094-4412	139-1540	
Hydraulic	4I-3948	126-1813	
Air Primary	7Y-0404		
Air Secondary	5I-5208		

FILTER TYPE	PART NUMBER	HIGH EFFICIENCY	FIRE RESISTANT
320 Excavator			1TL1-UP
Engine Oil	1R-0739		
Fuel Primary	9M-2341		
Fuel Secondary	1R-0751		
Hydraulic	094-4412	139-1540	
Hydraulic	4I-3948	126-1813	
Air Primary	7Y-0404		
Air Secondary	5I-5208		
320 Excavator			1XM1-UP
Engine Oil	1R-0739		
Engine Oil	5I-7950		
Fuel Secondary	5I-7951		
Hydraulic	094-4412	139-1540	
Hydraulic	4I-3948	126-1813	
Air Primary	7Y-0404		
Air Secondary	5I-5208		
320 Excavator			2DL1-UP
Engine Oil	1R-0739		
Engine Oil	5I-7950		
Fuel Secondary	5I-7951		
Hydraulic	094-4412	139-1540	
Hydraulic	4I-3948	126-1813	
Air Primary	7Y-0404		
Air Secondary	5I-5208		
320 Excavator			3XK1-821
Engine Oil	1R-0739		
Fuel Primary	9M-2341		
Fuel Secondary	1R-0751		
Hydraulic	094-4412	139-1540	
Hydraulic	4I-3948	126-1813	
Air Primary	7Y-0404		
Air Secondary	5I-5208		
320 Excavator			3XK822-UP
Engine Oil	1R-0739		
Fuel Primary	9M-2341		
Fuel Secondary	1R-0751		
Fuel Secondary	1R-0753		
Hydraulic	094-4412	139-1540	
Hydraulic	4I-3948	126-1813	
Air Primary	7Y-0404		
Air Secondary	5I-5208		
320 Excavator			4ZJ1-459
Engine Oil	1R-0739		
Fuel Primary	9M-2341		
Fuel Secondary	1R-0751		
Hydraulic	094-4412	139-1540	
Hydraulic	4I-3948	126-1813	
Air Primary	7Y-0404		
Air Secondary	5I-5208		

a - For quantities, refer to parts book.

Filters - Excavators

FILTER TYPE	PART NUMBER	HIGH EFFICIENCY	FIRE RESISTANT
320 Excavator		4ZJ460-UP	
Engine Oil	1R-0739		
Fuel Primary	9M-2341		
Fuel Secondary	1R-0751		
Fuel Secondary	1R-0753		
Hydraulic	094-4412	139-1540	
Hydraulic	4I-3948	126-1813	
Air Primary	7Y-0404		
Air Secondary	5I-5208		
320 Excavator		6KM1-UP	
Engine Oil	1R-0739		
Fuel Primary	9M-2341		
Fuel Secondary	1R-0751		
Fuel Secondary	1R-0753		
Hydraulic	094-4412	139-1540	
Hydraulic	4I-3948	126-1813	
Air Primary	7Y-0404		
Air Secondary	5I-5208		
320 Excavator		7WK1-UP	
Engine Oil	1R-0739		
Fuel Primary	9M-2341		
Fuel Secondary	1R-0751		
Hydraulic	094-4412	139-1540	
Hydraulic	4I-3948	126-1813	
Air Primary	7Y-0404		
Air Secondary	5I-5208		
320 Excavator		8LK1-UP	
Engine Oil	1R-0739		
Engine Oil	5I-7950		
Fuel Secondary	5I-7951		
Hydraulic	093-7521		
Hydraulic	094-4412	139-1540	
Hydraulic	4I-3948	126-1813	
Air Primary	7Y-0404		
Air Secondary	5I-5208		
320 Excavator		9KK1-UP	
Engine Oil	1R-0739		
Engine Oil	5I-7950		
Fuel Secondary	5I-7951		
Hydraulic	094-4412	139-1540	
Hydraulic	4I-3948	126-1813	
Air Primary	7Y-0404		
Air Secondary	5I-5208		
320 Excavator		9WG1-722	
Engine Oil	1R-0739		
Fuel Primary	9M-2341		
Fuel Secondary	1R-0751		
Hydraulic	094-4412	139-1540	

FILTER TYPE	PART NUMBER	HIGH EFFICIENCY	FIRE RESISTANT
320 Excavator (cont.)		9WG1-722	
Hydraulic	4I-3948	126-1813	
Air Primary	7Y-0404		
Air Secondary	5I-5208		
320 Excavator		9WG723-UP	
Engine Oil	1R-0739		
Fuel Primary	9M-2341		
Fuel Secondary	1R-0751		
Fuel Secondary	1R-0753		
Hydraulic	094-4412	139-1540	
Hydraulic	4I-3948	126-1813	
Air Primary	7Y-0404		
Air Secondary	5I-5208		
320B Excavator		1XS1-UP	
Engine Oil	1R-0739		
Fuel Primary	117-4089		
Fuel Secondary	1R-0751		
Fuel Secondary	1R-0753		
Hydraulic	093-7521		
Hydraulic	126-2081	126-2131	
Hydraulic	143-2849		
Hydraulic	184-3931		
Hydraulic	4I-3948	126-1813	
Air Primary	131-8822		
Air Primary	6I-2501		
Air Secondary	131-8821		
Air Secondary	6I-2502		
320B Excavator		2AS1-UP	
Engine Oil	1R-0739		
Fuel Primary	117-4089		
Fuel Secondary	1R-0751		
Fuel Secondary	1R-0753		
Hydraulic	093-7521		
Hydraulic	126-2081	126-2131	
Hydraulic	143-2849		
Hydraulic	4I-3948	126-1813	
Air Primary	131-8822		
Air Primary	6I-2501		
Air Secondary	131-8821		
Air Secondary	6I-2502		
320B Excavator		3YZ1-UP	
Engine Oil	1R-0739		
Fuel Primary	117-4089		
Fuel Secondary	1R-0751		
Fuel Secondary	1R-0753		
Hydraulic	093-7521		
Hydraulic	126-2081	126-2131	
Hydraulic	143-2849		

a - For quantities, refer to parts book.

Filters - Excavators

FILTER TYPE	PART NUMBER	HIGH EFFICIENCY	FIRE RESISTANT
320B Excavator (cont.)			3YZ1-UP
Hydraulic	184-3931		
Hydraulic	4I-3948	126-1813	
Air Primary	131-8822		
Air Secondary	131-8821		
320B Excavator			4XW1-UP
Engine Oil	1R-0739		
Fuel Primary	117-4089		
Fuel Secondary	1R-0751		
Fuel Secondary	5I-7951		
Hydraulic	093-7521		
Hydraulic	126-2081	126-2131	
Hydraulic	4I-3948	126-1813	
Air Primary	131-8822		
Air Secondary	131-8821		
320B Excavator			5BR1-UP
Engine Oil	1R-0739		
Fuel Primary	117-4089		
Fuel Secondary	5I-7951		
Hydraulic	093-7521		
Hydraulic	126-2081	126-2131	
Hydraulic	4I-3948	126-1813	
Air Primary	131-8822		
Air Primary	6I-2501		
Air Secondary	131-8821		
Air Secondary	6I-2502		
320B Excavator			5GW1-UP
Engine Oil	1R-0739		
Fuel Primary	117-4089		
Fuel Secondary	1R-0751		
Fuel Secondary	5I-7951		
Hydraulic	093-7521		
Hydraulic	126-2081	126-2131	
Hydraulic	4I-3948	126-1813	
Air Primary	131-8822		
Air Secondary	131-8821		
320B Excavator			5MS1-UP
Engine Oil	1R-0739		
Fuel Primary	117-4089		
Fuel Secondary	1R-0751		
Fuel Secondary	1R-0753		
Hydraulic	093-7521		
Hydraulic	126-2081	126-2131	
Hydraulic	143-2849		
Hydraulic	184-3931		
Hydraulic	4I-3948	126-1813	
Air Primary	131-8822		
Air Secondary	131-8821		

FILTER TYPE	PART NUMBER	HIGH EFFICIENCY	FIRE RESISTANT
320B Excavator			6CR1-UP
Engine Oil	1R-0739		
Fuel Primary	117-4089		
Fuel Secondary	5I-7951		
Hydraulic	093-7521		
Hydraulic	126-2081	126-2131	
Hydraulic	4I-3948	126-1813	
Air Primary	131-8822		
Air Primary	6I-2501		
Air Secondary	131-8821		
Air Secondary	6I-2502		
320B Excavator			6LW1-UP
Engine Oil	1R-0739		
Fuel Primary	117-4089		
Fuel Secondary	1R-0751		
Fuel Secondary	1R-0753		
Hydraulic	093-7521		
Hydraulic	126-2081	126-2131	
Hydraulic	143-2849		
Hydraulic	184-3931		
Hydraulic	4I-3948	126-1813	
Air Primary	131-8822		
Air Secondary	131-8821		
320B Excavator			7JR1-UP
Engine Oil	1R-0739		
Fuel Primary	117-4089		
Fuel Secondary	1R-0751		
Fuel Secondary	1R-0753		
Hydraulic	093-7521		
Hydraulic	126-2081	126-2131	
Hydraulic	143-2849		
Hydraulic	184-3931		
Hydraulic	4I-3948	126-1813	
Air Primary	131-8822		
Air Primary	6I-2501		
Air Secondary	131-8821		
Air Secondary	6I-2502		
320B Excavator			9WS1-UP
Engine Oil	1R-0739		
Fuel Primary	117-4089		
Fuel Secondary	1R-0751		
Fuel Secondary	1R-0753		
Hydraulic	093-7521		
Hydraulic	126-2081	126-2131	
Hydraulic	143-2849		
Hydraulic	184-3931		
Hydraulic	4I-3948	126-1813	
Air Primary	131-8822		

a - For quantities, refer to parts book.

Filters - Excavators

FILTER TYPE	PART NUMBER	HIGH EFFICIENCY	FIRE RESISTANT
320B Excavator (cont.)			9WS1-UP
Air Primary	6I-2501		
Air Secondary	131-8821		
Air Secondary	6I-2502		
320B L Excavator			4XW1-UP
Engine Oil	1R-0739		
Fuel Primary	117-4089		
Fuel Secondary	1R-0751		
Fuel Secondary	5I-7951		
Hydraulic	093-7521		
Hydraulic	126-2081	126-2131	
Hydraulic	4I-3948	126-1813	
Air Primary	131-8822		
Air Secondary	131-8821		
320B L Excavator			5BR1-UP
Engine Oil	1R-0739		
Fuel Primary	117-4089		
Fuel Secondary	5I-7951		
Hydraulic	093-7521		
Hydraulic	126-2081	126-2131	
Hydraulic	4I-3948	126-1813	
Air Primary	131-8822		
Air Primary	6I-2501		
Air Secondary	131-8821		
Air Secondary	6I-2502		
320B L Excavator			5GW1-UP
Engine Oil	1R-0739		
Fuel Primary	117-4089		
Fuel Secondary	1R-0751		
Fuel Secondary	5I-7951		
Hydraulic	093-7521		
Hydraulic	126-2081	126-2131	
Hydraulic	4I-3948	126-1813	
Air Primary	131-8822		
Air Secondary	131-8821		
320B L Excavator			6CR1-UP
Engine Oil	1R-0739		
Fuel Primary	117-4089		
Fuel Secondary	5I-7951		
Hydraulic	093-7521		
Hydraulic	126-2081	126-2131	
Hydraulic	4I-3948	126-1813	
Air Primary	131-8822		
Air Primary	6I-2501		
Air Secondary	131-8821		
Air Secondary	6I-2502		

FILTER TYPE	PART NUMBER	HIGH EFFICIENCY	FIRE RESISTANT
320B LN Excavator			1XS1-UP
Engine Oil	1R-0739		
Fuel Primary	117-4089		
Fuel Secondary	1R-0751		
Fuel Secondary	1R-0753		
Hydraulic	093-7521		
Hydraulic	126-2081	126-2131	
Hydraulic	143-2849		
Hydraulic	184-3931		
Hydraulic	4I-3948	126-1813	
Air Primary	131-8822		
Air Primary	6I-2501		
Air Secondary	131-8821		
Air Secondary	6I-2502		
320B LN Excavator			2AS1-UP
Engine Oil	1R-0739		
Fuel Primary	117-4089		
Fuel Secondary	1R-0751		
Fuel Secondary	1R-0753		
Hydraulic	093-7521		
Hydraulic	126-2081	126-2131	
Hydraulic	143-2849		
Hydraulic	4I-3948	126-1813	
Air Primary	131-8822		
Air Primary	6I-2501		
Air Secondary	131-8821		
Air Secondary	6I-2502		
320B LN Excavator			3YZ1-UP
Engine Oil	1R-0739		
Fuel Primary	117-4089		
Fuel Secondary	1R-0751		
Fuel Secondary	1R-0753		
Hydraulic	093-7521		
Hydraulic	126-2081	126-2131	
Hydraulic	143-2849		
Hydraulic	184-3931		
Hydraulic	4I-3948	126-1813	
Air Primary	131-8822		
Air Secondary	131-8821		
320B LN Excavator			5MS1-UP
Engine Oil	1R-0739		
Fuel Primary	117-4089		
Fuel Secondary	1R-0751		
Fuel Secondary	1R-0753		
Hydraulic	093-7521		
Hydraulic	126-2081	126-2131	
Hydraulic	143-2849		
Hydraulic	184-3931		

a - For quantities, refer to parts book.

Filters - Excavators

FILTER TYPE	PART NUMBER	HIGH EFFICIENCY	FIRE RESISTANT
320B LN Excavator (cont.)			5MS1-UP
Hydraulic	4I-3948	126-1813	
Air Primary	131-8822		
Air Secondary	131-8821		
320B LN Excavator			6LW1-UP
Engine Oil	1R-0739		
Fuel Primary	117-4089		
Fuel Secondary	1R-0751		
Fuel Secondary	1R-0753		
Hydraulic	093-7521		
Hydraulic	126-2081	126-2131	
Hydraulic	143-2849		
Hydraulic	184-3931		
Hydraulic	4I-3948	126-1813	
Air Primary	131-8822		
Air Secondary	131-8821		
320B LN Excavator			7JR1-UP
Engine Oil	1R-0739		
Fuel Primary	117-4089		
Fuel Secondary	1R-0751		
Fuel Secondary	1R-0753		
Hydraulic	093-7521		
Hydraulic	126-2081	126-2131	
Hydraulic	143-2849		
Hydraulic	184-3931		
Hydraulic	4I-3948	126-1813	
Air Primary	131-8822		
Air Primary	6I-2501		
Air Secondary	131-8821		
Air Secondary	6I-2502		
320B LN Excavator			9WS1-UP
Engine Oil	1R-0739		
Fuel Primary	117-4089		
Fuel Secondary	1R-0751		
Fuel Secondary	1R-0753		
Hydraulic	093-7521		
Hydraulic	126-2081	126-2131	
Hydraulic	143-2849		
Hydraulic	184-3931		
Hydraulic	4I-3948	126-1813	
Air Primary	131-8822		
Air Primary	6I-2501		
Air Secondary	131-8821		
Air Secondary	6I-2502		
320B LU Excavator			BAN1-UP
Engine Oil	1R-0739		
Fuel Primary	117-4089		
Fuel Secondary	5I-7951		

FILTER TYPE	PART NUMBER	HIGH EFFICIENCY	FIRE RESISTANT
320B LU Excavator (cont.)			BAN1-UP
Hydraulic	094-4412	139-1540	
Hydraulic	4I-3948	126-1813	
Air Primary	131-8822		
Air Secondary	131-8821		
320B LU Excavator			BBG1-UP
Engine Oil	1R-0739		
Fuel Primary	117-4089		
Fuel Secondary	5I-7951		
Hydraulic	094-4412	139-1540	
Hydraulic	4I-3948	126-1813	
Air Primary	131-8822		
Air Secondary	131-8821		
320B N Excavator			1XS1-UP
Engine Oil	1R-0739		
Fuel Primary	117-4089		
Fuel Secondary	1R-0751		
Fuel Secondary	1R-0753		
Hydraulic	093-7521		
Hydraulic	126-2081	126-2131	
Hydraulic	143-2849		
Hydraulic	184-3931		
Hydraulic	4I-3948	126-1813	
Air Primary	131-8822		
Air Primary	6I-2501		
Air Secondary	131-8821		
Air Secondary	6I-2502		
320B N Excavator			2AS1-UP
Engine Oil	1R-0739		
Fuel Primary	117-4089		
Fuel Secondary	1R-0751		
Fuel Secondary	1R-0753		
Hydraulic	093-7521		
Hydraulic	126-2081	126-2131	
Hydraulic	143-2849		
Hydraulic	4I-3948	126-1813	
Air Primary	131-8822		
Air Primary	6I-2501		
Air Secondary	131-8821		
Air Secondary	6I-2502		
320B N Excavator			3YZ1-UP
Engine Oil	1R-0739		
Fuel Primary	117-4089		
Fuel Secondary	1R-0751		
Fuel Secondary	1R-0753		
Hydraulic	093-7521		
Hydraulic	126-2081	126-2131	
Hydraulic	143-2849		

a - For quantities, refer to parts book.

Filters - Excavators

FILTER TYPE	PART NUMBER	HIGH EFFICIENCY	FIRE RESISTANT
320B N Excavator (cont.)			3YZ1-UP
Hydraulic	184-3931		
Hydraulic	4I-3948	126-1813	
Air Primary	131-8822		
Air Secondary	131-8821		
320B N Excavator			4NR1-UP
Engine Oil	1R-0739		
Fuel Primary	117-4089		
Fuel Secondary	5I-7951		
Hydraulic	093-7521		
Hydraulic	126-2081	126-2131	
Hydraulic	4I-3948	126-1813	
Air Primary	131-8822		
Air Secondary	131-8821		
320B N Excavator			5MS1-UP
Engine Oil	1R-0739		
Fuel Primary	117-4089		
Fuel Secondary	1R-0751		
Fuel Secondary	1R-0753		
Hydraulic	093-7521		
Hydraulic	126-2081	126-2131	
Hydraulic	143-2849		
Hydraulic	184-3931		
Hydraulic	4I-3948	126-1813	
Air Primary	131-8822		
Air Secondary	131-8821		
320B N Excavator			6LW1-UP
Engine Oil	1R-0739		
Fuel Primary	117-4089		
Fuel Secondary	1R-0751		
Fuel Secondary	1R-0753		
Hydraulic	093-7521		
Hydraulic	126-2081	126-2131	
Hydraulic	143-2849		
Hydraulic	184-3931		
Hydraulic	4I-3948	126-1813	
Air Primary	131-8822		
Air Secondary	131-8821		
320B N Excavator			7JR1-UP
Engine Oil	1R-0739		
Fuel Primary	117-4089		
Fuel Secondary	1R-0751		
Fuel Secondary	1R-0753		
Hydraulic	093-7521		
Hydraulic	126-2081	126-2131	
Hydraulic	143-2849		
Hydraulic	184-3931		
Hydraulic	4I-3948	126-1813	

FILTER TYPE	PART NUMBER	HIGH EFFICIENCY	FIRE RESISTANT
320B N Excavator (cont.)			7JR1-UP
Air Primary	131-8822		
Air Primary	6I-2501		
Air Secondary	131-8821		
Air Secondary	6I-2502		
320B N Excavator			9WS1-UP
Engine Oil	1R-0739		
Fuel Primary	117-4089		
Fuel Secondary	1R-0751		
Fuel Secondary	1R-0753		
Hydraulic	093-7521		
Hydraulic	126-2081	126-2131	
Hydraulic	143-2849		
Hydraulic	184-3931		
Hydraulic	4I-3948	126-1813	
Air Primary	131-8822		
Air Primary	6I-2501		
Air Secondary	131-8821		
Air Secondary	6I-2502		
320B S Excavator			1XS1-UP
Engine Oil	1R-0739		
Fuel Primary	117-4089		
Fuel Secondary	1R-0751		
Fuel Secondary	1R-0753		
Hydraulic	093-7521		
Hydraulic	126-2081	126-2131	
Hydraulic	143-2849		
Hydraulic	184-3931		
Hydraulic	4I-3948	126-1813	
Air Primary	131-8822		
Air Primary	6I-2501		
Air Secondary	131-8821		
Air Secondary	6I-2502		
320B S Excavator			2AS1-UP
Engine Oil	1R-0739		
Fuel Primary	117-4089		
Fuel Secondary	1R-0751		
Fuel Secondary	1R-0753		
Hydraulic	093-7521		
Hydraulic	126-2081	126-2131	
Hydraulic	143-2849		
Hydraulic	4I-3948	126-1813	
Air Primary	131-8822		
Air Primary	6I-2501		
Air Secondary	131-8821		
Air Secondary	6I-2502		
320B S Excavator			3YZ1-UP
Engine Oil	1R-0739		

a - For quantities, refer to parts book.

Filters - Excavators

FILTER TYPE	PART NUMBER	HIGH EFFICIENCY	FIRE RESISTANT
320B S Excavator (cont.)			3YZ1-UP
Fuel Primary	117-4089		
Fuel Secondary	1R-0751		
Fuel Secondary	1R-0753		
Hydraulic	093-7521		
Hydraulic	126-2081	126-2131	
Hydraulic	143-2849		
Hydraulic	184-3931		
Hydraulic	4I-3948	126-1813	
Air Primary	131-8822		
Air Secondary	131-8821		
320B S Excavator			5MS1-UP
Engine Oil	1R-0739		
Fuel Primary	117-4089		
Fuel Secondary	1R-0751		
Fuel Secondary	1R-0753		
Hydraulic	093-7521		
Hydraulic	126-2081	126-2131	
Hydraulic	143-2849		
Hydraulic	184-3931		
Hydraulic	4I-3948	126-1813	
Air Primary	131-8822		
Air Secondary	131-8821		
320B S Excavator			6LW1-UP
Engine Oil	1R-0739		
Fuel Primary	117-4089		
Fuel Secondary	1R-0751		
Fuel Secondary	1R-0753		
Hydraulic	093-7521		
Hydraulic	126-2081	126-2131	
Hydraulic	143-2849		
Hydraulic	184-3931		
Hydraulic	4I-3948	126-1813	
Air Primary	131-8822		
Air Secondary	131-8821		
320B S Excavator			7JR1-UP
Engine Oil	1R-0739		
Fuel Primary	117-4089		
Fuel Secondary	1R-0751		
Fuel Secondary	1R-0753		
Hydraulic	093-7521		
Hydraulic	126-2081	126-2131	
Hydraulic	143-2849		
Hydraulic	184-3931		
Hydraulic	4I-3948	126-1813	
Air Primary	131-8822		
Air Primary	6I-2501		
Air Secondary	131-8821		

FILTER TYPE	PART NUMBER	HIGH EFFICIENCY	FIRE RESISTANT
320B S Excavator (cont.)			7JR1-UP
Air Secondary	6I-2502		
320B S Excavator			9WS1-UP
Engine Oil	1R-0739		
Fuel Primary	117-4089		
Fuel Secondary	1R-0751		
Fuel Secondary	1R-0753		
Hydraulic	093-7521		
Hydraulic	126-2081	126-2131	
Hydraulic	143-2849		
Hydraulic	184-3931		
Hydraulic	4I-3948	126-1813	
Air Primary	131-8822		
Air Primary	6I-2501		
Air Secondary	131-8821		
Air Secondary	6I-2502		
320B U Excavator			BAN1-UP
Engine Oil	1R-0739		
Fuel Primary	117-4089		
Fuel Secondary	5I-7951		
Hydraulic	094-4412	139-1540	
Hydraulic	4I-3948	126-1813	
Air Primary	131-8822		
Air Secondary	131-8821		
320B U Excavator			BBG1-UP
Engine Oil	1R-0739		
Fuel Primary	117-4089		
Fuel Secondary	5I-7951		
Hydraulic	094-4412	139-1540	
Hydraulic	4I-3948	126-1813	
Air Primary	131-8822		
Air Secondary	131-8821		
320C Excavator			AMC1-UP
Engine Oil	1R-0739		
Fuel Primary	117-4089		
Fuel Secondary	1R-0751		
Hydraulic	093-7521		
Hydraulic	126-2081	126-2131	
Hydraulic	5I-8670		
Air Primary	131-8822		
Air Primary	6I-2501		
Air Secondary	131-8821		
Air Secondary	6I-2502		
320C Excavator			ANB1-UP
Engine Oil	1R-0739		
Fuel Primary	117-4089		
Fuel Secondary	1R-0751		
Hydraulic	093-7521		

a - For quantities, refer to parts book.

Filters - Excavators

FILTER TYPE	PART NUMBER	HIGH EFFICIENCY	FIRE RESISTANT
320C Excavator (cont.)			ANB1-UP
Hydraulic	126-2081	126-2131	
Hydraulic	5I-8670		
Air Primary	131-8822		
Air Primary	6I-2501		
Air Secondary	131-8821		
Air Secondary	6I-2502		
320C Excavator			BBC1-UP
Engine Oil	1R-0739		
Fuel Primary	117-4089		
Fuel Secondary	1R-0751		
Hydraulic	093-7521		
Hydraulic	126-2081	126-2131	
Hydraulic	5I-8670		
Air Primary	131-8822		
Air Secondary	131-8821		
320C Excavator			BCN1-UP
Engine Oil	1R-0739		
Fuel Primary	117-4089		
Fuel Secondary	1R-0751		
Hydraulic	093-7521		
Hydraulic	126-2081	126-2131	
Air Primary	131-8822		
Air Secondary	131-8821		
320C Excavator			BDC1-UP
Engine Oil	1R-0739		
Fuel Primary	117-4089		
Fuel Secondary	1R-0751		
Hydraulic	093-7521		
Hydraulic	126-2081	126-2131	
Hydraulic	5I-8670		
Air Primary	131-8822		
Air Secondary	131-8821		
320C Excavator			BDE1-UP
Engine Oil	1R-0739		
Fuel Primary	117-4089		
Fuel Secondary	1R-0751		
Hydraulic	093-7521		
Hydraulic	126-2081	126-2131	
Air Primary	131-8822		
Air Secondary	131-8821		
320C Excavator			BEA1-UP
Engine Oil	1R-0739		
Fuel Primary	117-4089		
Fuel Secondary	1R-0751		
Hydraulic	093-7521		
Hydraulic	126-2081	126-2131	
Air Primary	131-8822		

FILTER TYPE	PART NUMBER	HIGH EFFICIENCY	FIRE RESISTANT
320C Excavator (cont.)			BEA1-UP
Air Secondary	131-8821		
320C Excavator			BEF1-UP
Engine Oil	1R-0739		
Fuel Primary	117-4089		
Fuel Secondary	1R-0751		
Hydraulic	093-7521		
Hydraulic	126-2081	126-2131	
Hydraulic	5I-8670		
Air Primary	131-8822		
Air Secondary	131-8821		
320C Excavator			BER1-UP
Engine Oil	1R-0739		
Fuel Primary	117-4089		
Fuel Secondary	1R-0751		
Hydraulic	093-7521		
Hydraulic	126-2081	126-2131	
Hydraulic	5I-8670		
Air Primary	131-8822		
Air Secondary	131-8821		
320C Excavator			BPR1-UP
Engine Oil	1R-0739		
Fuel Primary	117-4089		
Fuel Secondary	1R-0751		
Hydraulic	093-7521		
Hydraulic	126-2081	126-2131	
Hydraulic	5I-8670		
Air Primary	131-8822		
Air Secondary	131-8821		
320C Excavator			BRX1-UP
Engine Oil	1R-0739		
Fuel Primary	117-4089		
Fuel Secondary	1R-0751		
Hydraulic	093-7521		
Hydraulic	126-2081	126-2131	
Hydraulic	5I-8670		
Air Primary	131-8822		
Air Secondary	131-8821		
320C L Excavator			AMC1-UP
Engine Oil	1R-0739		
Fuel Primary	117-4089		
Fuel Secondary	1R-0751		
Hydraulic	093-7521		
Hydraulic	126-2081	126-2131	
Hydraulic	5I-8670		
Air Primary	131-8822		
Air Primary	6I-2501		
Air Secondary	131-8821		

a - For quantities, refer to parts book.

Filters - Excavators

FILTER TYPE	PART NUMBER	HIGH EFFICIENCY	FIRE RESISTANT
320C L Excavator (cont.)			AMC1-UP
Air Secondary	6I-2502		
320C L Excavator			ANB1-UP
Engine Oil	1R-0739		
Fuel Primary	117-4089		
Fuel Secondary	1R-0751		
Hydraulic	093-7521		
Hydraulic	126-2081	126-2131	
Hydraulic	5I-8670		
Air Primary	131-8822		
Air Primary	6I-2501		
Air Secondary	131-8821		
Air Secondary	6I-2502		
320C L Excavator			BBC1-UP
Engine Oil	1R-0739		
Fuel Primary	117-4089		
Fuel Secondary	1R-0751		
Hydraulic	093-7521		
Hydraulic	126-2081	126-2131	
Hydraulic	5I-8670		
Air Primary	131-8822		
Air Secondary	131-8821		
320C L Excavator			BCN1-UP
Engine Oil	1R-0739		
Fuel Primary	117-4089		
Fuel Secondary	1R-0751		
Hydraulic	093-7521		
Hydraulic	126-2081	126-2131	
Air Primary	131-8822		
Air Secondary	131-8821		
320C L Excavator			BDC1-UP
Engine Oil	1R-0739		
Fuel Primary	117-4089		
Fuel Secondary	1R-0751		
Hydraulic	093-7521		
Hydraulic	126-2081	126-2131	
Hydraulic	5I-8670		
Air Primary	131-8822		
Air Secondary	131-8821		
320C L Excavator			BDE1-UP
Engine Oil	1R-0739		
Fuel Primary	117-4089		
Fuel Secondary	1R-0751		
Hydraulic	093-7521		
Hydraulic	126-2081	126-2131	
Air Primary	131-8822		
Air Secondary	131-8821		

FILTER TYPE	PART NUMBER	HIGH EFFICIENCY	FIRE RESISTANT
320C L Excavator			BEA1-UP
Engine Oil	1R-0739		
Fuel Primary	117-4089		
Fuel Secondary	1R-0751		
Hydraulic	093-7521		
Hydraulic	126-2081	126-2131	
Air Primary	131-8822		
Air Secondary	131-8821		
320C L Excavator			BEF1-UP
Engine Oil	1R-0739		
Fuel Primary	117-4089		
Fuel Secondary	1R-0751		
Hydraulic	093-7521		
Hydraulic	126-2081	126-2131	
Hydraulic	5I-8670		
Air Primary	131-8822		
Air Secondary	131-8821		
320C L Excavator			BER1-UP
Engine Oil	1R-0739		
Fuel Primary	117-4089		
Fuel Secondary	1R-0751		
Hydraulic	093-7521		
Hydraulic	126-2081	126-2131	
Hydraulic	5I-8670		
Air Primary	131-8822		
Air Secondary	131-8821		
320C L Excavator			BPR1-UP
Engine Oil	1R-0739		
Fuel Primary	117-4089		
Fuel Secondary	1R-0751		
Hydraulic	093-7521		
Hydraulic	126-2081	126-2131	
Hydraulic	5I-8670		
Air Primary	131-8822		
Air Secondary	131-8821		
320C L Excavator			BRX1-UP
Engine Oil	1R-0739		
Fuel Primary	117-4089		
Fuel Secondary	1R-0751		
Hydraulic	093-7521		
Hydraulic	126-2081	126-2131	
Hydraulic	5I-8670		
Air Primary	131-8822		
Air Secondary	131-8821		
320C LN Excavator			BCN1-UP
Engine Oil	1R-0739		
Fuel Primary	117-4089		
Fuel Secondary	1R-0751		

a - For quantities, refer to parts book.

Filters - Excavators

FILTER TYPE	PART NUMBER	HIGH EFFICIENCY	FIRE RESISTANT
320C LN Excavator (cont.)			BCN1-UP
Hydraulic	093-7521		
Hydraulic	126-2081	126-2131	
Air Primary	131-8822		
Air Secondary	131-8821		
320C LN Excavator			BDE1-UP
Engine Oil	1R-0739		
Fuel Primary	117-4089		
Fuel Secondary	1R-0751		
Hydraulic	093-7521		
Hydraulic	126-2081	126-2131	
Air Primary	131-8822		
Air Secondary	131-8821		
320C LN Excavator			BEA1-UP
Engine Oil	1R-0739		
Fuel Primary	117-4089		
Fuel Secondary	1R-0751		
Hydraulic	093-7521		
Hydraulic	126-2081	126-2131	
Air Primary	131-8822		
Air Secondary	131-8821		
320C LU Excavator			CLM1-UP
Engine Oil	1R-0739		
Fuel Primary	117-4089		
Fuel Secondary	1R-0751		
Hydraulic	093-7521		
Hydraulic	126-2081	126-2131	
Hydraulic	5I-8670		
Air Primary	131-8822		
Air Secondary	131-8821		
320C LU Excavator			CLZ1-UP
Engine Oil	1R-0739		
Fuel Primary	117-4089		
Fuel Secondary	1R-0751		
Hydraulic	093-7521		
Hydraulic	126-2081	126-2131	
Hydraulic	5I-8670		
Air Primary	131-8822		
Air Secondary	131-8821		
320C U Excavator			CLM1-UP
Engine Oil	1R-0739		
Fuel Primary	117-4089		
Fuel Secondary	1R-0751		
Hydraulic	093-7521		
Hydraulic	126-2081	126-2131	
Hydraulic	5I-8670		
Air Primary	131-8822		
Air Secondary	131-8821		

FILTER TYPE	PART NUMBER	HIGH EFFICIENCY	FIRE RESISTANT
320C U Excavator			CLZ1-UP
Engine Oil	1R-0739		
Fuel Primary	117-4089		
Fuel Secondary	1R-0751		
Hydraulic	093-7521		
Hydraulic	126-2081	126-2131	
Hydraulic	5I-8670		
Air Primary	131-8822		
Air Secondary	131-8821		
320L Excavator			1KL1-UP
Engine Oil	1R-0739		
Engine Oil	5I-7950		
Fuel Secondary	5I-7951		
Hydraulic	093-7521		
Hydraulic	094-4412	139-1540	
Hydraulic	4I-3948	126-1813	
Air Primary	7Y-0404		
Air Secondary	5I-5208		
320L Excavator			1TL1-UP
Engine Oil	1R-0739		
Fuel Primary	9M-2341		
Fuel Secondary	1R-0751		
Hydraulic	094-4412	139-1540	
Hydraulic	4I-3948	126-1813	
Air Primary	7Y-0404		
Air Secondary	5I-5208		
320L Excavator			2DL1-213
Engine Oil	1R-0739		
Engine Oil	5I-7950		
Fuel Secondary	5I-7951		
Hydraulic	094-4412	139-1540	
Hydraulic	4I-3948	126-1813	
Air Primary	7Y-0404		
Air Secondary	5I-5208		
320L Excavator			7WK1-UP
Engine Oil	1R-0739		
Fuel Primary	9M-2341		
Fuel Secondary	1R-0751		
Hydraulic	094-4412	139-1540	
Hydraulic	4I-3948	126-1813	
Air Primary	7Y-0404		
Air Secondary	5I-5208		
320L Excavator			8LK1-UP
Engine Oil	1R-0739		
Engine Oil	5I-7950		
Fuel Secondary	5I-7951		
Hydraulic	093-7521		
Hydraulic	094-4412	139-1540	

a - For quantities, refer to parts book.

Filters - Excavators

FILTER TYPE	PART NUMBER	HIGH EFFICIENCY	FIRE RESISTANT
320L Excavator (cont.)			8LK1-UP
Hydraulic	4I-3948	126-1813	
Air Primary	7Y-0404		
Air Secondary	5I-5208		
320L Excavator			9KK1-1358
Engine Oil	1R-0739		
Engine Oil	5I-7950		
Fuel Secondary	5I-7951		
Hydraulic	094-4412	139-1540	
Hydraulic	4I-3948	126-1813	
Air Primary	7Y-0404		
Air Secondary	5I-5208		
320L Excavator			1XM1-UP
Engine Oil	1R-0739		
Engine Oil	5I-7950		
Fuel Secondary	5I-7951		
Hydraulic	094-4412	139-1540	
Hydraulic	4I-3948	126-1813	
Air Primary	7Y-0404		
Air Secondary	5I-5208		
320L Excavator			2DL214-UP
Engine Oil	1R-0739		
Engine Oil	5I-7950		
Fuel Secondary	5I-7951		
Hydraulic	094-4412	139-1540	
Hydraulic	4I-3948	126-1813	
Air Primary	7Y-0404		
Air Secondary	5I-5208		
320L Excavator			3XK1-UP
Engine Oil	1R-0739		
Fuel Primary	9M-2341		
Fuel Secondary	1R-0751		
Hydraulic	094-4412	139-1540	
Hydraulic	4I-3948	126-1813	
Air Primary	7Y-0404		
Air Secondary	5I-5208		
320L Excavator			4ZJ1-459
Engine Oil	1R-0739		
Fuel Primary	9M-2341		
Fuel Secondary	1R-0751		
Hydraulic	094-4412	139-1540	
Hydraulic	4I-3948	126-1813	
Air Primary	7Y-0404		
Air Secondary	5I-5208		
320L Excavator			4ZJ460-UP
Engine Oil	1R-0739		
Fuel Primary	9M-2341		
Fuel Secondary	1R-0751		

FILTER TYPE	PART NUMBER	HIGH EFFICIENCY	FIRE RESISTANT
320L Excavator (cont.)			4ZJ460-UP
Fuel Secondary	1R-0753		
Hydraulic	094-4412	139-1540	
Hydraulic	4I-3948	126-1813	
Air Primary	7Y-0404		
Air Secondary	5I-5208		
320L Excavator			6KM1-UP
Engine Oil	1R-0739		
Fuel Primary	9M-2341		
Fuel Secondary	1R-0751		
Fuel Secondary	1R-0753		
Hydraulic	094-4412	139-1540	
Hydraulic	4I-3948	126-1813	
Air Primary	7Y-0404		
Air Secondary	5I-5208		
320L Excavator			9KK1359-UP
Engine Oil	1R-0739		
Engine Oil	5I-7950		
Fuel Secondary	5I-7951		
Hydraulic	094-4412	139-1540	
Hydraulic	4I-3948	126-1813	
Air Primary	7Y-0404		
Air Secondary	5I-5208		
320L Excavator			9WG1-722
Engine Oil	1R-0739		
Fuel Primary	9M-2341		
Fuel Secondary	1R-0751		
Hydraulic	094-4412	139-1540	
Hydraulic	4I-3948	126-1813	
Air Primary	7Y-0404		
Air Secondary	5I-5208		
320L Excavator			9WG723-UP
Engine Oil	1R-0739		
Fuel Primary	9M-2341		
Fuel Secondary	1R-0751		
Fuel Secondary	1R-0753		
Hydraulic	094-4412	139-1540	
Hydraulic	4I-3948	126-1813	
Air Primary	7Y-0404		
Air Secondary	5I-5208		
320N Excavator			1XM1-UP
Engine Oil	1R-0739		
Engine Oil	5I-7950		
Fuel Secondary	5I-7951		
Hydraulic	094-4412	139-1540	
Hydraulic	4I-3948	126-1813	
Air Primary	7Y-0404		
Air Secondary	5I-5208		

a - For quantities, refer to parts book.

Filters - Excavators

FILTER TYPE	PART NUMBER	HIGH EFFICIENCY	FIRE RESISTANT
320N Excavator		2DL214-UP	
Engine Oil	1R-0739		
Engine Oil	5I-7950		
Fuel Secondary	5I-7951		
Hydraulic	094-4412	139-1540	
Hydraulic	4I-3948	126-1813	
Air Primary	7Y-0404		
Air Secondary	5I-5208		
320N Excavator		3XK1-821	
Engine Oil	1R-0739		
Fuel Primary	9M-2341		
Fuel Secondary	1R-0751		
Hydraulic	094-4412	139-1540	
Hydraulic	4I-3948	126-1813	
Air Primary	7Y-0404		
Air Secondary	5I-5208		
320N Excavator		3XK822-UP	
Engine Oil	1R-0739		
Fuel Primary	9M-2341		
Fuel Secondary	1R-0751		
Fuel Secondary	1R-0753		
Hydraulic	094-4412	139-1540	
Hydraulic	4I-3948	126-1813	
Air Primary	7Y-0404		
Air Secondary	5I-5208		
320N Excavator		4ZJ1-459	
Engine Oil	1R-0739		
Fuel Primary	9M-2341		
Fuel Secondary	1R-0751		
Hydraulic	094-4412	139-1540	
Hydraulic	4I-3948	126-1813	
Air Primary	7Y-0404		
Air Secondary	5I-5208		
320N Excavator		4ZJ460-UP	
Engine Oil	1R-0739		
Fuel Primary	9M-2341		
Fuel Secondary	1R-0751		
Fuel Secondary	1R-0753		
Hydraulic	094-4412	139-1540	
Hydraulic	4I-3948	126-1813	
Air Primary	7Y-0404		
Air Secondary	5I-5208		
320N Excavator		6KM1-UP	
Engine Oil	1R-0739		
Fuel Primary	9M-2341		
Fuel Secondary	1R-0751		
Fuel Secondary	1R-0753		
Hydraulic	094-4412	139-1540	

FILTER TYPE	PART NUMBER	HIGH EFFICIENCY	FIRE RESISTANT
320N Excavator (cont.)		6KM1-UP	
Hydraulic	4I-3948	126-1813	
Air Primary	7Y-0404		
Air Secondary	5I-5208		
320N Excavator		9KK1359-UP	
Engine Oil	1R-0739		
Engine Oil	5I-7950		
Fuel Secondary	5I-7951		
Hydraulic	094-4412	139-1540	
Hydraulic	4I-3948	126-1813	
Air Primary	7Y-0404		
Air Secondary	5I-5208		
320N Excavator		9WG1-722	
Engine Oil	1R-0739		
Fuel Primary	9M-2341		
Fuel Secondary	1R-0751		
Hydraulic	094-4412	139-1540	
Hydraulic	4I-3948	126-1813	
Air Primary	7Y-0404		
Air Secondary	5I-5208		
320N Excavator		9WG723-UP	
Engine Oil	1R-0739		
Fuel Primary	9M-2341		
Fuel Secondary	1R-0751		
Fuel Secondary	1R-0753		
Hydraulic	094-4412	139-1540	
Hydraulic	4I-3948	126-1813	
Air Primary	7Y-0404		
Air Secondary	5I-5208		
320S Excavator		3XK822-UP	
Engine Oil	1R-0739		
Fuel Primary	9M-2341		
Fuel Secondary	1R-0751		
Fuel Secondary	1R-0753		
Hydraulic	094-4412	139-1540	
Hydraulic	4I-3948	126-1813	
Air Primary	7Y-0404		
Air Secondary	5I-5208		
320S Excavator		4ZJ460-UP	
Engine Oil	1R-0739		
Fuel Primary	9M-2341		
Fuel Secondary	1R-0751		
Fuel Secondary	1R-0753		
Hydraulic	094-4412	139-1540	
Hydraulic	4I-3948	126-1813	
Air Primary	7Y-0404		
Air Secondary	5I-5208		

a - For quantities, refer to parts book.

Filters - Excavators

FILTER TYPE	PART NUMBER	HIGH EFFICIENCY	FIRE RESISTANT
320S Excavator			6KM1-UP
Engine Oil	1R-0739		
Fuel Primary	9M-2341		
Fuel Secondary	1R-0751		
Fuel Secondary	1R-0753		
Hydraulic	094-4412	139-1540	
Hydraulic	4I-3948	126-1813	
Air Primary	7Y-0404		
Air Secondary	5I-5208		
320S Excavator			9WG723-UP
Engine Oil	1R-0739		
Fuel Primary	9M-2341		
Fuel Secondary	1R-0751		
Fuel Secondary	1R-0753		
Hydraulic	094-4412	139-1540	
Hydraulic	4I-3948	126-1813	
Air Primary	7Y-0404		
Air Secondary	5I-5208		
322 Excavator			7WL1-UP
Engine Oil	1R-0739		
Fuel Primary	9M-2341		
Fuel Secondary	1R-0751		
Hydraulic	094-4412	139-1540	
Hydraulic	4I-3948	126-1813	
Air Primary	7Y-0404		
Air Secondary	5I-5208		
322 Excavator			8CL1-UP
Engine Oil	1R-0739		
Fuel Primary	9M-2341		
Fuel Secondary	1R-0751		
Hydraulic	094-4412	139-1540	
Hydraulic	4I-3948	126-1813	
Air Primary	7Y-0404		
Air Secondary	5I-5208		
322 LN Excavator			4RM1-UP
Engine Oil	1R-0739		
Fuel Primary	9M-2341		
Fuel Secondary	1R-0751		
Fuel Secondary	1R-0753		
Hydraulic	094-4412	139-1540	
Hydraulic	4I-3948	126-1813	
Air Primary	7Y-0404		
Air Secondary	5I-5208		
322 LN Excavator			8ML1-UP
Engine Oil	1R-0739		
Fuel Primary	9M-2341		
Fuel Secondary	1R-0751		
Fuel Secondary	1R-0753		

FILTER TYPE	PART NUMBER	HIGH EFFICIENCY	FIRE RESISTANT
322 LN Excavator (cont.)			8ML1-UP
Hydraulic	094-4412	139-1540	
Hydraulic	4I-3948	126-1813	
Air Primary	7Y-0404		
Air Secondary	5I-5208		
322 LN Excavator			9JL1-UP
Engine Oil	1R-0739		
Fuel Primary	9M-2341		
Fuel Secondary	1R-0751		
Fuel Secondary	1R-0753		
Hydraulic	094-4412	139-1540	
Hydraulic	4I-3948	126-1813	
Air Primary	7Y-0404		
Air Secondary	5I-5208		
322 N Excavator			4RM1-UP
Engine Oil	1R-0739		
Fuel Primary	9M-2341		
Fuel Secondary	1R-0751		
Fuel Secondary	1R-0753		
Hydraulic	094-4412	139-1540	
Hydraulic	4I-3948	126-1813	
Air Primary	7Y-0404		
Air Secondary	5I-5208		
322 N Excavator			8ML1-UP
Engine Oil	1R-0739		
Fuel Primary	9M-2341		
Fuel Secondary	1R-0751		
Fuel Secondary	1R-0753		
Hydraulic	094-4412	139-1540	
Hydraulic	4I-3948	126-1813	
Air Primary	7Y-0404		
Air Secondary	5I-5208		
322 N Excavator			9JL1-UP
Engine Oil	1R-0739		
Fuel Primary	9M-2341		
Fuel Secondary	1R-0751		
Fuel Secondary	1R-0753		
Hydraulic	094-4412	139-1540	
Hydraulic	4I-3948	126-1813	
Air Primary	7Y-0404		
Air Secondary	5I-5208		
322B Excavator			8MR1-UP
Engine Oil	1R-0739		
Fuel Primary	117-4089		
Fuel Secondary	1R-0751		
Fuel Secondary	1R-0753		
Hydraulic	093-7521		
Hydraulic	126-2081	126-2131	

a - For quantities, refer to parts book.

Filters - Excavators

FILTER TYPE	PART NUMBER	HIGH EFFICIENCY	FIRE RESISTANT
322B Excavator (cont.)			8MR1-UP
Hydraulic	4I-3948	126-1813	
Air Primary	131-8822		
Air Primary	6I-2501		
Air Secondary	131-8821		
Air Secondary	6I-2502		
322B Excavator			8NR1-UP
Engine Oil	1R-0739		
Fuel Primary	117-4089		
Fuel Secondary	1R-0751		
Fuel Secondary	1R-0753		
Hydraulic	093-7521		
Hydraulic	126-2081	126-2131	
Hydraulic	4I-3948	126-1813	
Air Primary	131-8822		
Air Primary	6I-2501		
Air Secondary	131-8821		
Air Secondary	6I-2502		
322B L Excavator			1AS1-UP
Engine Oil	1R-0739		
Fuel Primary	117-4089		
Fuel Secondary	1R-0751		
Hydraulic	093-7521		
Hydraulic	126-2081	126-2131	
Hydraulic	4I-3948	126-1813	
Air Primary	131-8822		
Air Secondary	131-8821		
322B L Excavator			1ES1-UP
Engine Oil	1R-0739		
Fuel Primary	117-4089		
Fuel Secondary	5I-7951		
Hydraulic	093-7521		
Hydraulic	126-2081	126-2131	
Hydraulic	4I-3948	126-1813	
Air Primary	131-8822		
Air Secondary	131-8821		
322B L Excavator			1YS1-UP
Engine Oil	1R-0739		
Fuel Primary	117-4089		
Fuel Secondary	1R-0751		
Fuel Secondary	1R-0753		
Hydraulic	093-7521		
Hydraulic	126-2081	126-2131	
Hydraulic	4I-3948	126-1813	
Air Primary	128-2686		
Air Primary	131-8822		
Air Primary	6I-2501		
Air Secondary	131-8821		

FILTER TYPE	PART NUMBER	HIGH EFFICIENCY	FIRE RESISTANT
322B L Excavator (cont.)			1YS1-UP
Air Secondary	6I-2502		
322B L Excavator			1ZS1-UP
Engine Oil	1R-0739		
Fuel Primary	117-4089		
Fuel Secondary	1R-0751		
Fuel Secondary	1R-0753		
Hydraulic	093-7521		
Hydraulic	126-2081	126-2131	
Hydraulic	143-2849		
Hydraulic	184-3931		
Hydraulic	4I-3948	126-1813	
Air Primary	131-8822		
Air Primary	6I-2501		
Air Secondary	131-8821		
Air Secondary	6I-2502		
322B L Excavator			2ES1-UP
Engine Oil	1R-0739		
Fuel Primary	117-4089		
Fuel Secondary	1R-0751		
Fuel Secondary	1R-0753		
Hydraulic	093-7521		
Hydraulic	126-2081	126-2131	
Hydraulic	143-2849		
Hydraulic	184-3931		
Hydraulic	4I-3948	126-1813	
Air Primary	131-8822		
Air Primary	6I-2501		
Air Secondary	131-8821		
Air Secondary	6I-2502		
322B L Excavator			8MR1-UP
Engine Oil	1R-0739		
Fuel Primary	117-4089		
Fuel Secondary	1R-0751		
Fuel Secondary	1R-0753		
Hydraulic	093-7521		
Hydraulic	126-2081	126-2131	
Hydraulic	4I-3948	126-1813	
Air Primary	131-8822		
Air Primary	6I-2501		
Air Secondary	131-8821		
Air Secondary	6I-2502		
322B L Excavator			8NR1-UP
Engine Oil	1R-0739		
Fuel Primary	117-4089		
Fuel Secondary	1R-0751		
Fuel Secondary	1R-0753		
Hydraulic	093-7521		

a - For quantities, refer to parts book.

Filters - Excavators

FILTER TYPE	PART NUMBER	HIGH EFFICIENCY	FIRE RESISTANT
322B L Excavator (cont.)			8NR1-UP
Hydraulic	126-2081	126-2131	
Hydraulic	4I-3948	126-1813	
Air Primary	131-8822		
Air Primary	6I-2501		
Air Secondary	131-8821		
Air Secondary	6I-2502		
322B LN Excavator			1ZS1-UP
Engine Oil	1R-0739		
Fuel Primary	117-4089		
Fuel Secondary	1R-0751		
Fuel Secondary	1R-0753		
Hydraulic	093-7521		
Hydraulic	126-2081	126-2131	
Hydraulic	143-2849		
Hydraulic	184-3931		
Hydraulic	4I-3948	126-1813	
Air Primary	131-8822		
Air Primary	6I-2501		
Air Secondary	131-8821		
Air Secondary	6I-2502		
322B LN Excavator			2ES1-UP
Engine Oil	1R-0739		
Fuel Primary	117-4089		
Fuel Secondary	1R-0751		
Fuel Secondary	1R-0753		
Hydraulic	093-7521		
Hydraulic	126-2081	126-2131	
Hydraulic	143-2849		
Hydraulic	184-3931		
Hydraulic	4I-3948	126-1813	
Air Primary	131-8822		
Air Primary	6I-2501		
Air Secondary	131-8821		
Air Secondary	6I-2502		
322C Excavator			BKM1-UP
Engine Oil	1R-0739		
Fuel Primary	1R-0770		
Fuel Secondary	1R-0751		
Fuel Secondary	1R-0753		
Hydraulic	093-7521		
Hydraulic	126-2081	126-2131	
Hydraulic	5I-8670		
Air Primary	131-8822		
Air Primary	6I-2501		
Air Secondary	131-8821		
Air Secondary	6I-2502		

FILTER TYPE	PART NUMBER	HIGH EFFICIENCY	FIRE RESISTANT
322C Excavator			BLP1-UP
Engine Oil	1R-0739		
Fuel Primary	1R-0770		
Fuel Secondary	1R-0751		
Fuel Secondary	1R-0753		
Hydraulic	093-7521		
Hydraulic	126-2081	126-2131	
Hydraulic	5I-8670		
Air Primary	131-8822		
Air Primary	6I-2501		
Air Secondary	131-8821		
Air Secondary	6I-2502		
322C Excavator			BFK1-UP
Engine Oil	1R-0739		
Fuel Secondary	1R-0751		
Fuel Secondary	1R-0753		
Hydraulic	093-7521		
Hydraulic	126-2081	126-2131	
Hydraulic	143-2849		
Air Primary	131-8822		
Air Primary	6I-2501		
Air Secondary	131-8821		
Air Secondary	6I-2502		
322C Excavator			BGR1-UP
Engine Oil	1R-0739		
Fuel Secondary	1R-0751		
Fuel Secondary	1R-0753		
Hydraulic	093-7521		
Hydraulic	126-2081	126-2131	
Hydraulic	143-2849		
Air Primary	131-8822		
Air Primary	6I-2501		
Air Secondary	131-8821		
Air Secondary	6I-2502		
322C L Excavator			BKJ1-UP
Engine Oil	1R-0739		
Fuel Primary	1R-0770		
Fuel Secondary	1R-0751		
Fuel Secondary	1R-0753		
Hydraulic	093-7521		
Hydraulic	126-1813		
Hydraulic	126-2081	126-2131	
Air Primary	131-8822		
Air Primary	6I-2501		
Air Secondary	131-8821		
Air Secondary	6I-2502		
322C L Excavator			BKM1-UP
Engine Oil	1R-0739		

a - For quantities, refer to parts book.

Filters - Excavators

FILTER TYPE	PART NUMBER	HIGH EFFICIENCY	FIRE RESISTANT
322C L Excavator (cont.)			BKM1-UP
Fuel Primary	1R-0770		
Fuel Secondary	1R-0751		
Fuel Secondary	1R-0753		
Hydraulic	093-7521		
Hydraulic	126-2081	126-2131	
Hydraulic	5I-8670		
Air Primary	131-8822		
Air Primary	6I-2501		
Air Secondary	131-8821		
Air Secondary	6I-2502		
322C L Excavator			BLP1-UP
Engine Oil	1R-0739		
Fuel Primary	1R-0770		
Fuel Secondary	1R-0751		
Fuel Secondary	1R-0753		
Hydraulic	093-7521		
Hydraulic	126-2081	126-2131	
Hydraulic	5I-8670		
Air Primary	131-8822		
Air Primary	6I-2501		
Air Secondary	131-8821		
Air Secondary	6I-2502		
322C LN Excavator			BFK1-UP
Engine Oil	1R-0739		
Fuel Secondary	1R-0751		
Fuel Secondary	1R-0753		
Hydraulic	093-7521		
Hydraulic	126-2081	126-2131	
Hydraulic	143-2849		
Air Primary	131-8822		
Air Primary	6I-2501		
Air Secondary	131-8821		
Air Secondary	6I-2502		
322C LN Excavator			BGR1-UP
Engine Oil	1R-0739		
Fuel Secondary	1R-0751		
Fuel Secondary	1R-0753		
Hydraulic	093-7521		
Hydraulic	126-2081	126-2131	
Hydraulic	143-2849		
Air Primary	131-8822		
Air Primary	6I-2501		
Air Secondary	131-8821		
Air Secondary	6I-2502		
322L Excavator			4RM1-UP
Engine Oil	1R-0739		
Fuel Primary	9M-2341		

FILTER TYPE	PART NUMBER	HIGH EFFICIENCY	FIRE RESISTANT
322L Excavator (cont.)			4RM1-UP
Fuel Secondary	1R-0751		
Fuel Secondary	1R-0753		
Hydraulic	094-4412	139-1540	
Hydraulic	4I-3948	126-1813	
Air Primary	7Y-0404		
Air Secondary	5I-5208		
322L Excavator			7WL1-UP
Engine Oil	1R-0739		
Fuel Primary	9M-2341		
Fuel Secondary	1R-0751		
Hydraulic	094-4412	139-1540	
Hydraulic	4I-3948	126-1813	
Air Primary	7Y-0404		
Air Secondary	5I-5208		
322L Excavator			8CL1-UP
Engine Oil	1R-0739		
Fuel Primary	9M-2341		
Fuel Secondary	1R-0751		
Hydraulic	094-4412	139-1540	
Hydraulic	4I-3948	126-1813	
Air Primary	7Y-0404		
Air Secondary	5I-5208		
322L Excavator			8ML1-UP
Engine Oil	1R-0739		
Fuel Primary	9M-2341		
Fuel Secondary	1R-0751		
Fuel Secondary	1R-0753		
Hydraulic	094-4412	139-1540	
Hydraulic	4I-3948	126-1813	
Air Primary	7Y-0404		
Air Secondary	5I-5208		
322L Excavator			9JL1-UP
Engine Oil	1R-0739		
Fuel Primary	9M-2341		
Fuel Secondary	1R-0751		
Fuel Secondary	1R-0753		
Hydraulic	094-4412	139-1540	
Hydraulic	4I-3948	126-1813	
Air Primary	7Y-0404		
Air Secondary	5I-5208		
322L Excavator			9RL1-UP
Engine Oil	1R-0739		
Fuel Primary	9M-2341		
Fuel Secondary	1R-0751		
Fuel Secondary	1R-0753		
Hydraulic	094-4412	139-1540	
Hydraulic	4I-3948	126-1813	

a - For quantities, refer to parts book.

Filters - Excavators

FILTER TYPE	PART NUMBER	HIGH EFFICIENCY	FIRE RESISTANT
322L Excavator (cont.)			9RL1-UP
Air Primary	7Y-0404		
Air Secondary	5I-5208		
325 Excavator			2JK1-UP
Engine Oil	1R-0739		
Fuel Primary	9M-2341		
Fuel Secondary	1R-0751		
Hydraulic	094-4412	139-1540	
Hydraulic	4I-3948	126-1813	
Air Primary	7Y-0404		
Air Secondary	5I-5208		
325 Excavator			2SK1-UP
Engine Oil	1R-0739		
Fuel Primary	9M-2341		
Fuel Secondary	1R-0751		
Hydraulic	094-4412	139-1540	
Hydraulic	4I-3948	126-1813	
Air Primary	7Y-0404		
Air Secondary	5I-5208		
325 Excavator			2SL1-UP
Engine Oil	1R-0739		
Fuel Primary	9M-2341		
Fuel Secondary	1R-0751		
Hydraulic	094-4412	139-1540	
Hydraulic	4I-3948	126-1813	
Air Primary	7Y-0404		
Air Secondary	5I-5208		
325 Excavator			3LL1-UP
Engine Oil	1R-0739		
Fuel Primary	9M-2341		
Fuel Secondary	1R-0751		
Hydraulic	094-4412	139-1540	
Hydraulic	4I-3948	126-1813	
Air Primary	7Y-0404		
Air Secondary	5I-5208		
325 Excavator			5WK1-UP
Engine Oil	1R-0739		
Fuel Primary	9M-2341		
Fuel Secondary	1R-0751		
Hydraulic	094-4412	139-1540	
Hydraulic	4I-3948	126-1813	
Air Primary	7Y-0404		
Air Secondary	5I-5208		
325 Excavator			6KK1-UP
Engine Oil	1R-0739		
Fuel Primary	9M-2341		
Fuel Secondary	1R-0751		
Hydraulic	094-4412	139-1540	

FILTER TYPE	PART NUMBER	HIGH EFFICIENCY	FIRE RESISTANT
325 Excavator (cont.)			6KK1-UP
Hydraulic	4I-3948	126-1813	
Air Primary	7Y-0404		
Air Secondary	5I-5208		
325 Excavator			6RM1-UP
Engine Oil	1R-0739		
Fuel Primary	9M-2341		
Fuel Secondary	1R-0751		
Fuel Secondary	1R-0753		
Hydraulic	094-4412	139-1540	
Hydraulic	4I-3948	126-1813	
Air Primary	7Y-0404		
Air Secondary	5I-5208		
325 Excavator			7CJ1-UP
Engine Oil	1R-0739		
Fuel Primary	9M-2341		
Fuel Secondary	1R-0751		
Hydraulic	094-4412	139-1540	
Hydraulic	4I-3948	126-1813	
Air Primary	7Y-0404		
Air Secondary	5I-5208		
325 Excavator			7LJ1-UP
Engine Oil	1R-0739		
Fuel Primary	9M-2341		
Fuel Secondary	1R-0751		
Hydraulic	094-4412	139-1540	
Hydraulic	4I-3948	126-1813	
Air Primary	7Y-0404		
Air Secondary	5I-5208		
325 Excavator			7LM1-UP
Engine Oil	1R-0739		
Fuel Primary	9M-2341		
Fuel Secondary	1R-0751		
Fuel Secondary	1R-0753		
Hydraulic	094-4412	139-1540	
Hydraulic	4I-3948	126-1813	
Air Primary	7Y-0404		
Air Secondary	5I-5208		
325 Excavator			7TG1-UP
Engine Oil	1R-0739		
Fuel Primary	9M-2341		
Fuel Secondary	1R-0751		
Hydraulic	094-4412	139-1540	
Hydraulic	4I-3948	126-1813	
Air Primary	7Y-0404		
Air Secondary	5I-5208		
325 Excavator			8JG1-UP
Engine Oil	1R-0739		

a - For quantities, refer to parts book.

Filters - Excavators

FILTER TYPE	PART NUMBER	HIGH EFFICIENCY	FIRE RESISTANT
325 Excavator (cont.)			8JG1-UP
Fuel Primary	9M-2341		
Fuel Secondary	1R-0751		
Hydraulic	094-4412	139-1540	
Hydraulic	4I-3948	126-1813	
Air Primary	7Y-0404		
Air Secondary	5I-5208		
325 Excavator			8NK1-UP
Engine Oil	1R-0739		
Fuel Primary	9M-2341		
Fuel Secondary	1R-0751		
Hydraulic	094-4412	139-1540	
Hydraulic	4I-3948	126-1813	
Air Primary	7Y-0404		
Air Secondary	5I-5208		
325 Excavator			8NL1-UP
Engine Oil	1R-0739		
Fuel Primary	9M-2341		
Fuel Secondary	1R-0751		
Hydraulic	094-4412	139-1540	
Hydraulic	4I-3948	126-1813	
Air Primary	7Y-0404		
Air Secondary	5I-5208		
325 Excavator		8YK1-UP	
Engine Oil	1R-0739		
Fuel Primary	9M-2341		
Fuel Secondary	1R-0751		
Hydraulic	094-4412	139-1540	
Hydraulic	4I-3948	126-1813	
Air Primary	7Y-0404		
Air Secondary	5I-5208		
325 Excavator			9KL1-UP
Engine Oil	1R-0739		
Fuel Primary	9M-2341		
Fuel Secondary	1R-0751		
Hydraulic	094-4412	139-1540	
Hydraulic	4I-3948	126-1813	
Air Primary	7Y-0404		
Air Secondary	5I-5208		
325 Excavator		9SG1-UP	
Engine Oil	1R-0739		
Fuel Primary	9M-2341		
Fuel Secondary	1R-0751		
Hydraulic	094-4412	139-1540	
Hydraulic	4I-3948	126-1813	
Air Primary	7Y-0404		
Air Secondary	5I-5208		

FILTER TYPE	PART NUMBER	HIGH EFFICIENCY	FIRE RESISTANT
325 Excavator			9ZK1-UP
Engine Oil	1R-0739		
Fuel Primary	9M-2341		
Fuel Secondary	1R-0751		
Hydraulic	094-4412	139-1540	
Hydraulic	4I-3948	126-1813	
Air Primary	7Y-0404		
Air Secondary	5I-5208		
325 LN Excavator			2SK1-UP
Engine Oil	1R-0739		
Fuel Primary	9M-2341		
Fuel Secondary	1R-0751		
Hydraulic	094-4412	139-1540	
Hydraulic	4I-3948	126-1813	
Air Primary	7Y-0404		
Air Secondary	5I-5208		
325 LN Excavator			2SL1-UP
Engine Oil	1R-0739		
Fuel Primary	9M-2341		
Fuel Secondary	1R-0751		
Hydraulic	094-4412	139-1540	
Hydraulic	4I-3948	126-1813	
Air Primary	7Y-0404		
Air Secondary	5I-5208		
325 LN Excavator			3LL1-UP
Engine Oil	1R-0739		
Fuel Primary	9M-2341		
Fuel Secondary	1R-0751		
Hydraulic	094-4412	139-1540	
Hydraulic	4I-3948	126-1813	
Air Primary	7Y-0404		
Air Secondary	5I-5208		
325 LN Excavator			7LJ1-UP
Engine Oil	1R-0739		
Fuel Primary	9M-2341		
Fuel Secondary	1R-0751		
Hydraulic	094-4412	139-1540	
Hydraulic	4I-3948	126-1813	
Air Primary	7Y-0404		
Air Secondary	5I-5208		
325 LN Excavator			9SG1-UP
Engine Oil	1R-0739		
Fuel Primary	9M-2341		
Fuel Secondary	1R-0751		
Hydraulic	094-4412	139-1540	
Hydraulic	4I-3948	126-1813	
Air Primary	7Y-0404		
Air Secondary	5I-5208		

a - For quantities, refer to parts book.

Filters - Excavators

FILTER TYPE	PART NUMBER	HIGH EFFICIENCY	FIRE RESISTANT
325 LN Excavator			9ZK1-UP
Engine Oil	1R-0739		
Fuel Primary	9M-2341		
Fuel Secondary	1R-0751		
Hydraulic	094-4412	139-1540	
Hydraulic	4I-3948	126-1813	
Air Primary	7Y-0404		
Air Secondary	5I-5208		
325B Excavator			6DN1-UP
Engine Oil	1R-0739		
Fuel Primary	117-4089		
Fuel Secondary	1R-0751		
Fuel Secondary	1R-0753		
Hydraulic	093-7521		
Hydraulic	126-2081	126-2131	
Hydraulic	143-2849		
Hydraulic	184-3931		
Air Primary	131-8822		
Air Primary	6I-2501		
Air Secondary	131-8821		
Air Secondary	6I-2502		
325B Excavator			8FN1-UP
Engine Oil	1R-0739		
Fuel Primary	117-4089		
Fuel Secondary	1R-0751		
Fuel Secondary	1R-0753		
Hydraulic	093-7521		
Hydraulic	126-2081	126-2131	
Hydraulic	143-2849		
Hydraulic	184-3931		
Air Primary	131-8822		
Air Primary	6I-2501		
Air Secondary	131-8821		
Air Secondary	6I-2502		
325B Excavator			8PR1-UP
Engine Oil	1R-0739		
Fuel Primary	117-4089		
Fuel Secondary	1R-0751		
Fuel Secondary	1R-0753		
Hydraulic	093-7521		
Hydraulic	126-2081	126-2131	
Hydraulic	4I-3948	126-1813	
Air Primary	131-8822		
Air Primary	6I-2501		
Air Secondary	131-8821		
Air Secondary	6I-2502		
325B Excavator			8RR1-UP
Engine Oil	1R-0739		

FILTER TYPE	PART NUMBER	HIGH EFFICIENCY	FIRE RESISTANT
325B Excavator (cont.)			8RR1-UP
Fuel Primary	117-4089		
Fuel Secondary	1R-0751		
Fuel Secondary	1R-0753		
Hydraulic	093-7521		
Hydraulic	126-2081	126-2131	
Hydraulic	4I-3948	126-1813	
Air Primary	131-8822		
Air Primary	6I-2501		
Air Secondary	131-8821		
Air Secondary	6I-2502		
325B L Excavator			1GS1-UP
Engine Oil	1R-0739		
Fuel Primary	117-4089		
Fuel Secondary	1R-0751		
Fuel Secondary	1R-0753		
Hydraulic	093-7521		
Hydraulic	126-2081	126-2131	
Hydraulic	4I-3948	126-1813	
Air Primary	131-8822		
Air Secondary	131-8821		
325B L Excavator			2JR1-UP
Engine Oil	1R-0739		
Fuel Primary	117-4089		
Fuel Secondary	1R-0751		
Fuel Secondary	1R-0753		
Hydraulic	093-7521		
Hydraulic	126-2081	126-2131	
Hydraulic	184-3931		
Air Primary	131-8822		
Air Primary	6I-2501		
Air Secondary	131-8821		
Air Secondary	6I-2502		
325B L Excavator			4DS1-UP
Engine Oil	1R-0739		
Fuel Primary	117-4089		
Fuel Secondary	1R-0751		
Fuel Secondary	1R-0753		
Hydraulic	093-7521		
Hydraulic	126-2081	126-2131	
Hydraulic	143-2849		
Hydraulic	4I-3948	126-1813	
Air Primary	131-8822		
Air Primary	6I-2501		
Air Secondary	131-8821		
Air Secondary	6I-2502		
325B L Excavator			5BS1-UP
Engine Oil	1R-0739		

a - For quantities, refer to parts book.

Filters - Excavators

FILTER TYPE	PART NUMBER	HIGH EFFICIENCY	FIRE RESISTANT
325B L Excavator (cont.)			5BS1-UP
Fuel Primary	117-4089		
Fuel Secondary	1R-0751		
Fuel Secondary	1R-0753		
Hydraulic	093-7521		
Hydraulic	126-2081	126-2131	
Hydraulic	143-2849		
Hydraulic	4I-3948	126-1813	
Air Primary	131-8822		
Air Primary	6I-2501		
Air Secondary	131-8821		
Air Secondary	6I-2502		
325B L Excavator			8PR1-UP
Engine Oil	1R-0739		
Fuel Primary	117-4089		
Fuel Secondary	1R-0751		
Fuel Secondary	1R-0753		
Hydraulic	093-7521		
Hydraulic	126-2081	126-2131	
Hydraulic	4I-3948	126-1813	
Air Primary	131-8822		
Air Primary	6I-2501		
Air Secondary	131-8821		
Air Secondary	6I-2502		
325B L Excavator			8RR1-UP
Engine Oil	1R-0739		
Fuel Primary	117-4089		
Fuel Secondary	1R-0751		
Fuel Secondary	1R-0753		
Hydraulic	093-7521		
Hydraulic	126-2081	126-2131	
Hydraulic	4I-3948	126-1813	
Air Primary	131-8822		
Air Primary	6I-2501		
Air Secondary	131-8821		
Air Secondary	6I-2502		
325B LN Excavator			6DN1-UP
Engine Oil	1R-0739		
Fuel Primary	117-4089		
Fuel Secondary	1R-0751		
Fuel Secondary	1R-0753		
Hydraulic	093-7521		
Hydraulic	126-2081	126-2131	
Hydraulic	143-2849		
Hydraulic	184-3931		
Air Primary	131-8822		
Air Primary	6I-2501		
Air Secondary	131-8821		
Air Secondary	6I-2502		

FILTER TYPE	PART NUMBER	HIGH EFFICIENCY	FIRE RESISTANT
325B LN Excavator (cont.)			6DN1-UP
Air Secondary	6I-2502		
325B LN Excavator			8FN1-UP
Engine Oil	1R-0739		
Fuel Primary	117-4089		
Fuel Secondary	1R-0751		
Fuel Secondary	1R-0753		
Hydraulic	093-7521		
Hydraulic	126-2081	126-2131	
Hydraulic	143-2849		
Hydraulic	184-3931		
Air Primary	131-8822		
Air Primary	6I-2501		
Air Secondary	131-8821		
Air Secondary	6I-2502		
325B LN Excavator			4DS1-UP
Engine Oil	1R-0739		
Fuel Primary	117-4089		
Fuel Secondary	1R-0751		
Fuel Secondary	1R-0753		
Hydraulic	093-7521		
Hydraulic	126-2081	126-2131	
Hydraulic	143-2849		
Hydraulic	4I-3948	126-1813	
Air Primary	131-8822		
Air Primary	6I-2501		
Air Secondary	131-8821		
Air Secondary	6I-2502		
325B LN Excavator			5BS1-UP
Engine Oil	1R-0739		
Fuel Primary	117-4089		
Fuel Secondary	1R-0751		
Fuel Secondary	1R-0753		
Hydraulic	093-7521		
Hydraulic	126-2081	126-2131	
Hydraulic	143-2849		
Hydraulic	4I-3948	126-1813	
Air Primary	131-8822		
Air Primary	6I-2501		
Air Secondary	131-8821		
Air Secondary	6I-2502		
325B LN Excavator			6DN1-UP
Engine Oil	1R-0739		
Fuel Primary	117-4089		
Fuel Secondary	1R-0751		
Fuel Secondary	1R-0753		
Hydraulic	093-7521		
Hydraulic	126-2081	126-2131	
Hydraulic	143-2849		
Hydraulic	184-3931		
Air Primary	131-8822		
Air Primary	6I-2501		
Air Secondary	131-8821		
Air Secondary	6I-2502		

a - For quantities, refer to parts book.

Filters - Excavators

FILTER TYPE	PART NUMBER	HIGH EFFICIENCY	FIRE RESISTANT
325B LN Excavator (cont.)			6DN1-UP
Hydraulic	143-2849		
Hydraulic	184-3931		
Air Primary	131-8822		
Air Primary	6I-2501		
Air Secondary	131-8821		
Air Secondary	6I-2502		
325B LN Excavator			8FN1-UP
Engine Oil	1R-0739		
Fuel Primary	117-4089		
Fuel Secondary	1R-0751		
Fuel Secondary	1R-0753		
Hydraulic	093-7521		
Hydraulic	126-2081	126-2131	
Hydraulic	143-2849		
Hydraulic	184-3931		
Air Primary	131-8822		
Air Primary	6I-2501		
Air Secondary	131-8821		
Air Secondary	6I-2502		
325C Excavator			BKW1-UP
Engine Oil	1R-0739		
Fuel Primary	1R-0770		
Fuel Secondary	1R-0762		
Hydraulic	093-7521		
Hydraulic	126-2081	126-2131	
Hydraulic	1R-0739		
Hydraulic	5I-8670		
Air Primary	6I-2503		
Air Secondary	6I-2504		
325C Excavator			BMM1-UP
Engine Oil	1R-0739		
Fuel Primary	1R-0770		
Fuel Secondary	1R-0762		
Hydraulic	093-7521		
Hydraulic	126-2081	126-2131	
Hydraulic	1R-0739		
Hydraulic	5I-8670		
Air Primary	6I-2503		
Air Secondary	6I-2504		
325C L Excavator			BFE1-UP
Engine Oil	1R-0739		
Fuel Primary	1R-0770		
Fuel Secondary	1R-0762		
Hydraulic	093-7521		
Hydraulic	126-1813		
Hydraulic	126-2081	126-2131	
Hydraulic	1R-0739		

FILTER TYPE	PART NUMBER	HIGH EFFICIENCY	FIRE RESISTANT
325C L Excavator (cont.)			BFE1-UP
Air Primary	6I-2503		
Air Secondary	6I-2504		
325C L Excavator			BKW1-UP
Engine Oil	1R-0739		
Fuel Primary	1R-0770		
Fuel Secondary	1R-0762		
Hydraulic	093-7521		
Hydraulic	126-2081	126-2131	
Hydraulic	1R-0739		
Hydraulic	5I-8670		
Air Primary	6I-2503		
Air Secondary	6I-2504		
325C L Excavator			BMM1-UP
Engine Oil	1R-0739		
Fuel Primary	1R-0770		
Fuel Secondary	1R-0762		
Hydraulic	093-7521		
Hydraulic	126-2081	126-2131	
Hydraulic	1R-0739		
Hydraulic	5I-8670		
Air Primary	6I-2503		
Air Secondary	6I-2504		
325C L Excavator			CRB1-UP
Engine Oil	1R-0739		
Fuel Primary	1R-0770		
Fuel Secondary	1R-0762		
Hydraulic	093-7521		
Hydraulic	126-2081	126-2131	
Hydraulic	143-2849		
Hydraulic	1R-0739		
Air Primary	6I-2503		
Air Secondary	6I-2504		
325C L Excavator			CSJ1-UP
Engine Oil	1R-0739		
Fuel Primary	1R-0770		
Fuel Secondary	1R-0762		
Hydraulic	093-7521		
Hydraulic	126-2081	126-2131	
Hydraulic	143-2849		
Hydraulic	1R-0739		
Air Primary	6I-2503		
Air Secondary	6I-2504		
325C L Excavator			BKW1-UP
Engine Oil	1R-0739		
Fuel Primary	1R-0770		
Fuel Secondary	1R-0762		
Hydraulic	093-7521		
Hydraulic	126-1813		
Hydraulic	126-2081	126-2131	
Hydraulic	1R-0739		

a - For quantities, refer to parts book.

Filters - Excavators

FILTER TYPE	PART NUMBER	HIGH EFFICIENCY	FIRE RESISTANT
325C L Excavator (cont.)			BKW1-UP
Hydraulic	126-2081	126-2131	
Hydraulic	1R-0739		
Hydraulic	5I-8670		
Air Primary	6I-2503		
Air Secondary	6I-2504		
325C L Excavator			BMM1-UP
Engine Oil	1R-0739		
Fuel Primary	1R-0770		
Fuel Secondary	1R-0762		
Hydraulic	093-7521		
Hydraulic	126-2081	126-2131	
Hydraulic	1R-0739		
Hydraulic	5I-8670		
Air Primary	6I-2503		
Air Secondary	6I-2504		
325C LN Excavator			CRB1-UP
Engine Oil	1R-0739		
Fuel Primary	1R-0770		
Fuel Secondary	1R-0762		
Hydraulic	093-7521		
Hydraulic	126-2081	126-2131	
Hydraulic	143-2849		
Hydraulic	1R-0739		
Air Primary	6I-2503		
Air Secondary	6I-2504		
325C LN Excavator			CSJ1-UP
Engine Oil	1R-0739		
Fuel Primary	1R-0770		
Fuel Secondary	1R-0762		
Hydraulic	093-7521		
Hydraulic	126-2081	126-2131	
Hydraulic	143-2849		
Hydraulic	1R-0739		
Air Primary	6I-2503		
Air Secondary	6I-2504		
325L Excavator			2JK1-UP
Engine Oil	1R-0739		
Fuel Primary	9M-2341		
Fuel Secondary	1R-0751		
Hydraulic	094-4412	139-1540	
Hydraulic	4I-3948	126-1813	
Air Primary	7Y-0404		
Air Secondary	5I-5208		
325L Excavator			2SK1-UP
Engine Oil	1R-0739		
Fuel Primary	9M-2341		
Fuel Secondary	1R-0751		

FILTER TYPE	PART NUMBER	HIGH EFFICIENCY	FIRE RESISTANT
325L Excavator (cont.)			2SK1-UP
Hydraulic	094-4412	139-1540	
Hydraulic	4I-3948	126-1813	
Air Primary	7Y-0404		
Air Secondary	5I-5208		
325L Excavator			2SL1-UP
Engine Oil	1R-0739		
Fuel Primary	9M-2341		
Fuel Secondary	1R-0751		
Hydraulic	094-4412	139-1540	
Hydraulic	4I-3948	126-1813	
Air Primary	7Y-0404		
Air Secondary	5I-5208		
325L Excavator			3LL1-UP
Engine Oil	1R-0739		
Fuel Primary	9M-2341		
Fuel Secondary	1R-0751		
Hydraulic	094-4412	139-1540	
Hydraulic	4I-3948	126-1813	
Air Primary	7Y-0404		
Air Secondary	5I-5208		
325L Excavator			5WK1-UP
Engine Oil	1R-0739		
Fuel Primary	9M-2341		
Fuel Secondary	1R-0751		
Hydraulic	094-4412	139-1540	
Hydraulic	4I-3948	126-1813	
Air Primary	7Y-0404		
Air Secondary	5I-5208		
325L Excavator			6KK1-UP
Engine Oil	1R-0739		
Fuel Primary	9M-2341		
Fuel Secondary	1R-0751		
Hydraulic	094-4412	139-1540	
Hydraulic	4I-3948	126-1813	
Air Primary	7Y-0404		
Air Secondary	5I-5208		
325L Excavator			6RM1-UP
Engine Oil	1R-0739		
Fuel Primary	9M-2341		
Fuel Secondary	1R-0751		
Fuel Secondary	1R-0753		
Hydraulic	094-4412	139-1540	
Hydraulic	4I-3948	126-1813	
Air Primary	7Y-0404		
Air Secondary	5I-5208		
325L Excavator			7CJ1-UP
Engine Oil	1R-0739		

a - For quantities, refer to parts book.

Filters - Excavators

FILTER TYPE	PART NUMBER	HIGH EFFICIENCY	FIRE RESISTANT
325L Excavator (cont.)			7CJ1-UP
Fuel Primary	9M-2341		
Fuel Secondary	1R-0751		
Hydraulic	094-4412	139-1540	
Hydraulic	4I-3948	126-1813	
Air Primary	7Y-0404		
Air Secondary	5I-5208		
325L Excavator			7LJ1-UP
Engine Oil	1R-0739		
Fuel Primary	9M-2341		
Fuel Secondary	1R-0751		
Hydraulic	094-4412	139-1540	
Hydraulic	4I-3948	126-1813	
Air Primary	7Y-0404		
Air Secondary	5I-5208		
325L Excavator			7LM1-UP
Engine Oil	1R-0739		
Fuel Primary	9M-2341		
Fuel Secondary	1R-0751		
Fuel Secondary	1R-0753		
Hydraulic	094-4412	139-1540	
Hydraulic	4I-3948	126-1813	
Air Primary	7Y-0404		
Air Secondary	5I-5208		
325L Excavator			7TG1-UP
Engine Oil	1R-0739		
Fuel Primary	9M-2341		
Fuel Secondary	1R-0751		
Hydraulic	094-4412	139-1540	
Hydraulic	4I-3948	126-1813	
Air Primary	7Y-0404		
Air Secondary	5I-5208		
325L Excavator			8JG1-UP
Engine Oil	1R-0739		
Fuel Primary	9M-2341		
Fuel Secondary	1R-0751		
Hydraulic	094-4412	139-1540	
Hydraulic	4I-3948	126-1813	
Air Primary	7Y-0404		
Air Secondary	5I-5208		
325L Excavator			8NK1-UP
Engine Oil	1R-0739		
Fuel Primary	9M-2341		
Fuel Secondary	1R-0751		
Hydraulic	094-4412	139-1540	
Hydraulic	4I-3948	126-1813	
Air Primary	7Y-0404		
Air Secondary	5I-5208		

FILTER TYPE	PART NUMBER	HIGH EFFICIENCY	FIRE RESISTANT
325L Excavator			8NL1-UP
Engine Oil	1R-0739		
Fuel Primary	9M-2341		
Fuel Secondary	1R-0751		
Hydraulic	094-4412	139-1540	
Hydraulic	4I-3948	126-1813	
Air Primary	7Y-0404		
Air Secondary	5I-5208		
325L Excavator			8YK1-UP
Engine Oil	1R-0739		
Fuel Primary	9M-2341		
Fuel Secondary	1R-0751		
Hydraulic	094-4412	139-1540	
Hydraulic	4I-3948	126-1813	
Air Primary	7Y-0404		
Air Secondary	5I-5208		
325L Excavator			9KL1-UP
Engine Oil	1R-0739		
Fuel Primary	9M-2341		
Fuel Secondary	1R-0751		
Hydraulic	094-4412	139-1540	
Hydraulic	4I-3948	126-1813	
Air Primary	7Y-0404		
Air Secondary	5I-5208		
325L Excavator			9SG1-UP
Engine Oil	1R-0739		
Fuel Primary	9M-2341		
Fuel Secondary	1R-0751		
Hydraulic	094-4412	139-1540	
Hydraulic	4I-3948	126-1813	
Air Primary	7Y-0404		
Air Secondary	5I-5208		
325L Excavator			9ZK1-UP
Engine Oil	1R-0739		
Fuel Primary	9M-2341		
Fuel Secondary	1R-0751		
Hydraulic	094-4412	139-1540	
Hydraulic	4I-3948	126-1813	
Air Primary	7Y-0404		
Air Secondary	5I-5208		
330 Excavator			2EL1-UP
Engine Oil	1R-0739		
Fuel Primary	9M-2341		
Fuel Secondary	1R-0750		
Hydraulic	094-4412	139-1540	
Hydraulic	4I-3948	126-1813	
Air Primary	7Y-1323		
Air Secondary	7Y-1322		

a - For quantities, refer to parts book.

Filters - Excavators

FILTER TYPE	PART NUMBER	HIGH EFFICIENCY	FIRE RESISTANT
330 Excavator			2ZM1-UP
Engine Oil	1R-0739		
Fuel Primary	9M-2341		
Fuel Secondary	1R-0750		
Hydraulic	094-4412	139-1540	
Hydraulic	4I-3948	126-1813	
Air Primary	7Y-1323		
Air Secondary	7Y-1322		
330 Excavator			5YM1-UP
Engine Oil	1R-0739		
Fuel Primary	9M-2341		
Fuel Secondary	1R-0750		
Hydraulic	094-4412	139-1540	
Hydraulic	4I-3948	126-1813	
Air Primary	7Y-1323		
Air Secondary	7Y-1322		
330 Excavator			6SK1-UP
Engine Oil	1R-0739		
Fuel Primary	9M-2341		
Fuel Secondary	1R-0750		
Hydraulic	094-4412	139-1540	
Hydraulic	4I-3948	126-1813	
Air Primary	7Y-1323		
Air Secondary	7Y-1322		
330 Excavator			6WJ1-UP
Engine Oil	1R-0739		
Fuel Primary	9M-2341		
Fuel Secondary	1R-0750		
Hydraulic	094-4412	139-1540	
Hydraulic	4I-3948	126-1813	
Air Primary	7Y-1323		
Air Secondary	7Y-1322		
330 Excavator			6ZK1-UP
Engine Oil	1R-0739		
Fuel Primary	9M-2341		
Fuel Secondary	1R-0750		
Hydraulic	094-4412	139-1540	
Hydraulic	4I-3948	126-1813	
Air Primary	7Y-1323		
Air Secondary	7Y-1322		
330 Excavator			8CK1-UP
Engine Oil	1R-0739		
Fuel Primary	9M-2341		
Fuel Secondary	1R-0750		
Hydraulic	094-4412	139-1540	
Hydraulic	4I-3948	126-1813	
Air Primary	7Y-1323		
Air Secondary	7Y-1322		

FILTER TYPE	PART NUMBER	HIGH EFFICIENCY	FIRE RESISTANT
330 Excavator			8FK1-UP
Engine Oil	1R-0739		
Fuel Primary	9M-2341		
Fuel Secondary	1R-0750		
Hydraulic	094-4412	139-1540	
Hydraulic	4I-3948	126-1813	
Air Primary	7Y-1323		
Air Secondary	7Y-1322		
330 Excavator			8RL1-UP
Engine Oil	1R-0739		
Fuel Primary	9M-2341		
Fuel Secondary	1R-0750		
Hydraulic	094-4412	139-1540	
Hydraulic	4I-3948	126-1813	
Air Primary	7Y-1323		
Air Secondary	7Y-1322		
330 Excavator			9ML1-UP
Engine Oil	1R-0739		
Fuel Primary	9M-2341		
Fuel Secondary	1R-0750		
Hydraulic	094-4412	139-1540	
Hydraulic	4I-3948	126-1813	
Air Primary	7Y-1323		
Air Secondary	7Y-1322		
330 Excavator			9NG1-UP
Engine Oil	1R-0739		
Fuel Primary	9M-2341		
Fuel Secondary	1R-0750		
Hydraulic	094-4412	139-1540	
Hydraulic	4I-3948	126-1813	
Air Primary	7Y-1323		
Air Secondary	7Y-1322		
330 Excavator			9PJ1-UP
Engine Oil	1R-0739		
Fuel Primary	9M-2341		
Fuel Secondary	1R-0750		
Hydraulic	094-4412	139-1540	
Hydraulic	4I-3948	126-1813	
Air Primary	7Y-1323		
Air Secondary	7Y-1322		
330 Excavator			9WJ1-UP
Engine Oil	1R-0739		
Fuel Primary	9M-2341		
Fuel Secondary	1R-0750		
Hydraulic	094-4412	139-1540	
Hydraulic	4I-3948	126-1813	
Air Primary	7Y-1323		
Air Secondary	7Y-1322		

a - For quantities, refer to parts book.

Filters - Excavators

FILTER TYPE	PART NUMBER	HIGH EFFICIENCY	FIRE RESISTANT
330 L Excavator			2EL1-UP
Engine Oil	1R-0739		
Fuel Primary	9M-2341		
Fuel Secondary	1R-0750		
Hydraulic	094-4412	139-1540	
Hydraulic	4I-3948	126-1813	
Air Primary	7Y-1323		
Air Secondary	7Y-1322		
330 L Excavator			6ZK1-UP
Engine Oil	1R-0739		
Fuel Primary	9M-2341		
Fuel Secondary	1R-0750		
Hydraulic	094-4412	139-1540	
Hydraulic	4I-3948	126-1813	
Air Primary	7Y-1323		
Air Secondary	7Y-1322		
330 L Excavator			8CK1-UP
Engine Oil	1R-0739		
Fuel Primary	9M-2341		
Fuel Secondary	1R-0750		
Hydraulic	094-4412	139-1540	
Hydraulic	4I-3948	126-1813	
Air Primary	7Y-1323		
Air Secondary	7Y-1322		
330 L Excavator			2ZM1-UP
Engine Oil	1R-0739		
Fuel Primary	9M-2341		
Fuel Secondary	1R-0750		
Hydraulic	094-4412	139-1540	
Hydraulic	4I-3948	126-1813	
Air Primary	7Y-1323		
Air Secondary	7Y-1322		
330 L Excavator			5YM1-UP
Engine Oil	1R-0739		
Fuel Primary	9M-2341		
Fuel Secondary	1R-0750		
Hydraulic	094-4412	139-1540	
Hydraulic	4I-3948	126-1813	
Air Primary	7Y-1323		
Air Secondary	7Y-1322		
330 L Excavator			6SK1-UP
Engine Oil	1R-0739		
Fuel Primary	9M-2341		
Fuel Secondary	1R-0750		
Hydraulic	094-4412	139-1540	
Hydraulic	4I-3948	126-1813	
Air Primary	7Y-1323		
Air Secondary	7Y-1322		

FILTER TYPE	PART NUMBER	HIGH EFFICIENCY	FIRE RESISTANT
330 L Excavator			6WJ1-UP
Engine Oil	1R-0739		
Fuel Primary	9M-2341		
Fuel Secondary	1R-0750		
Hydraulic	094-4412	139-1540	
Hydraulic	4I-3948	126-1813	
Air Primary	7Y-1323		
Air Secondary	7Y-1322		
330 L Excavator			8FK1-UP
Engine Oil	1R-0739		
Fuel Primary	9M-2341		
Fuel Secondary	1R-0750		
Hydraulic	094-4412	139-1540	
Hydraulic	4I-3948	126-1813	
Air Primary	7Y-1323		
Air Secondary	7Y-1322		
330 L Excavator			8RL1-UP
Engine Oil	1R-0739		
Fuel Primary	9M-2341		
Fuel Secondary	1R-0750		
Hydraulic	094-4412	139-1540	
Hydraulic	4I-3948	126-1813	
Air Primary	7Y-1323		
Air Secondary	7Y-1322		
330 L Excavator			9ML1-UP
Engine Oil	1R-0739		
Fuel Primary	9M-2341		
Fuel Secondary	1R-0750		
Hydraulic	094-4412	139-1540	
Hydraulic	4I-3948	126-1813	
Air Primary	7Y-1323		
Air Secondary	7Y-1322		
330 L Excavator			9NG1-UP
Engine Oil	1R-0739		
Fuel Primary	9M-2341		
Fuel Secondary	1R-0750		
Hydraulic	094-4412	139-1540	
Hydraulic	4I-3948	126-1813	
Air Primary	7Y-1323		
Air Secondary	7Y-1322		
330 L Excavator			9PJ1-UP
Engine Oil	1R-0739		
Fuel Primary	9M-2341		
Fuel Secondary	1R-0750		
Hydraulic	094-4412	139-1540	
Hydraulic	4I-3948	126-1813	
Air Primary	7Y-1323		
Air Secondary	7Y-1322		

a - For quantities, refer to parts book.

Filters - Excavators

FILTER TYPE	PART NUMBER	HIGH EFFICIENCY	FIRE RESISTANT
330 L Excavator			9WJ1-UP
Engine Oil	1R-0739		
Fuel Primary	9M-2341		
Fuel Secondary	1R-0750		
Hydraulic	094-4412	139-1540	
Hydraulic	4I-3948	126-1813	
Air Primary	7Y-1323		
Air Secondary	7Y-1322		
330 LN Excavator			2EL1-UP
Engine Oil	1R-0739		
Fuel Primary	9M-2341		
Fuel Secondary	1R-0750		
Hydraulic	094-4412	139-1540	
Hydraulic	4I-3948	126-1813	
Air Primary	7Y-1323		
Air Secondary	7Y-1322		
330 LN Excavator			6ZK1-UP
Engine Oil	1R-0739		
Fuel Primary	9M-2341		
Fuel Secondary	1R-0750		
Hydraulic	094-4412	139-1540	
Hydraulic	4I-3948	126-1813	
Air Primary	7Y-1323		
Air Secondary	7Y-1322		
330 LN Excavator			8CK1-UP
Engine Oil	1R-0739		
Fuel Primary	9M-2341		
Fuel Secondary	1R-0750		
Hydraulic	094-4412	139-1540	
Hydraulic	4I-3948	126-1813	
Air Primary	7Y-1323		
Air Secondary	7Y-1322		
330B Excavator			4RS1-UP
Engine Oil	1R-0739		
Fuel Primary	9M-2341		
Fuel Secondary	1R-0750		
Hydraulic	093-7521		
Hydraulic	126-2081	126-2131	
Hydraulic	143-2849		
Hydraulic	4I-3948	126-1813	
Air Primary	6I-2503		
Air Secondary	6I-2504		
330B Excavator			5LS1-UP
Engine Oil	1R-0739		
Fuel Primary	9M-2341		
Fuel Secondary	1R-0750		
Hydraulic	093-7521		
Hydraulic	126-2081	126-2131	

FILTER TYPE	PART NUMBER	HIGH EFFICIENCY	FIRE RESISTANT
330B Excavator (cont.)			5LS1-UP
Hydraulic	143-2849		
Hydraulic	4I-3948	126-1813	
Air Primary	6I-2503		
Air Secondary	6I-2504		
330B Excavator			8SR1-UP
Engine Oil	1R-0739		
Fuel Primary	9M-2341		
Fuel Secondary	1R-0750		
Hydraulic	093-7521		
Hydraulic	126-2081	126-2131	
Hydraulic	4I-3948	126-1813	
Air Primary	6I-2503		
Air Secondary	6I-2504		
330B Excavator			8TR1-UP
Engine Oil	1R-0739		
Fuel Primary	9M-2341		
Fuel Secondary	1R-0750		
Hydraulic	093-7521		
Hydraulic	126-2081	126-2131	
Hydraulic	4I-3948	126-1813	
Air Primary	6I-2503		
Air Secondary	6I-2504		
330B Excavator			8SR1-UP
Engine Oil	1R-0739		
Fuel Primary	9M-2341		
Fuel Secondary	1R-0750		
Hydraulic	093-7521		
Hydraulic	126-2081	126-2131	
Hydraulic	4I-3948	126-1813	
Air Primary	6I-2503		
Air Secondary	6I-2504		
330B Excavator			8TR1-UP
Engine Oil	1R-0739		
Fuel Primary	9M-2341		
Fuel Secondary	1R-0750		
Hydraulic	093-7521		
Hydraulic	126-2081	126-2131	
Hydraulic	4I-3948	126-1813	
Air Primary	6I-2503		
Air Secondary	6I-2504		
330B L Excavator			1JS1-UP
Engine Oil	1R-0739		
Fuel Primary	9M-2341		
Fuel Secondary	1R-0750		
Hydraulic	093-7521		
Hydraulic	126-2081	126-2131	
Hydraulic	4I-3948	126-1813	

a - For quantities, refer to parts book.

Filters - Excavators

FILTER TYPE	PART NUMBER	HIGH EFFICIENCY	FIRE RESISTANT
330B L Excavator (cont.)			1JS1-UP
Air Primary	6I-2503		
Air Secondary	6I-2504		
330B L Excavator			3YR1-UP
Engine Oil	1R-0739		
Fuel Primary	9M-2341		
Fuel Secondary	1R-0750		
Hydraulic	093-7521		
Hydraulic	126-2081	126-2131	
Hydraulic	143-2849		
Hydraulic	184-3931		
Hydraulic	4I-3948	126-1813	
Air Primary	6I-2503		
Air Secondary	6I-2504		
330B L Excavator			4RS1-UP
Engine Oil	1R-0739		
Fuel Primary	9M-2341		
Fuel Secondary	1R-0750		
Hydraulic	093-7521		
Hydraulic	126-2081	126-2131	
Hydraulic	143-2849		
Hydraulic	4I-3948	126-1813	
Air Primary	6I-2503		
Air Secondary	6I-2504		
330B L Excavator			5LR1-UP
Engine Oil	1R-0739		
Fuel Primary	9M-2341		
Fuel Secondary	1R-0750		
Hydraulic	093-7521		
Hydraulic	126-2081	126-2131	
Hydraulic	143-2849		
Hydraulic	184-3931		
Hydraulic	4I-3948	126-1813	
Air Primary	6I-2503		
Air Secondary	6I-2504		
330B L Excavator			5LS1-UP
Engine Oil	1R-0739		
Fuel Primary	9M-2341		
Fuel Secondary	1R-0750		
Hydraulic	093-7521		
Hydraulic	126-2081	126-2131	
Hydraulic	143-2849		
Hydraulic	4I-3948	126-1813	
Air Primary	6I-2503		
Air Secondary	6I-2504		
330B L Excavator			6DR1-UP
Engine Oil	1R-0739		
Fuel Primary	117-4089		

FILTER TYPE	PART NUMBER	HIGH EFFICIENCY	FIRE RESISTANT
330B L Excavator (cont.)			6DR1-UP
Fuel Primary	9M-2341		
Fuel Secondary	1R-0750		
Hydraulic	093-7521		
Hydraulic	126-2081	126-2131	
Hydraulic	184-3931		
Air Primary	6I-2503		
Air Secondary	6I-2504		
330B L Excavator			8SR1-UP
Engine Oil	1R-0739		
Fuel Primary	9M-2341		
Fuel Secondary	1R-0750		
Hydraulic	093-7521		
Hydraulic	126-2081	126-2131	
Hydraulic	4I-3948	126-1813	
Air Primary	6I-2503		
Air Secondary	6I-2504		
330B L Excavator			8TR1-UP
Engine Oil	1R-0739		
Fuel Primary	9M-2341		
Fuel Secondary	1R-0750		
Hydraulic	093-7521		
Hydraulic	126-2081	126-2131	
Hydraulic	4I-3948	126-1813	
Air Primary	6I-2503		
Air Secondary	6I-2504		
330B LN Excavator			3YR1-UP
Engine Oil	1R-0739		
Fuel Primary	9M-2341		
Fuel Secondary	1R-0750		
Hydraulic	093-7521		
Hydraulic	126-2081	126-2131	
Hydraulic	143-2849		
Hydraulic	184-3931		
Hydraulic	4I-3948	126-1813	
Air Primary	6I-2503		
Air Secondary	6I-2504		
330C L Excavator			CGZ1-UP
Engine Oil	1R-0716		
Fuel Primary	1R-0770		
Fuel Secondary	1R-0762		
Hydraulic	093-7521		
Hydraulic	126-2081	126-2131	
Hydraulic	143-2849		
Air Primary	142-1339		
Air Secondary	142-1404		
330C L Excavator			DKY1-UP
Engine Oil	1R-0716		

a - For quantities, refer to parts book.

Filters - Excavators

FILTER TYPE	PART NUMBER	HIGH EFFICIENCY	FIRE RESISTANT
330C L Excavator (cont.)			DKY1-UP
Fuel Primary	1R-0770		
Fuel Secondary	1R-0762		
Hydraulic	093-7521		
Hydraulic	126-1813		
Hydraulic	126-2081	126-2131	
Air Primary	142-1339		
Air Secondary	142-1404		
330B LN Excavator			5LR1-UP
Engine Oil	1R-0739		
Fuel Primary	9M-2341		
Fuel Secondary	1R-0750		
Hydraulic	093-7521		
Hydraulic	126-2081	126-2131	
Hydraulic	143-2849		
Hydraulic	184-3931		
Hydraulic	4I-3948	126-1813	
Air Primary	6I-2503		
Air Secondary	6I-2504		
330C LN Excavator			CGZ1-UP
Engine Oil	1R-0716		
Fuel Primary	1R-0770		
Fuel Secondary	1R-0762		
Hydraulic	093-7521		
Hydraulic	126-2081	126-2131	
Hydraulic	143-2849		
Air Primary	142-1339		
Air Secondary	142-1404		
345B Excavator			2NW1-UP
Engine Oil	1R-0716		
Fuel Primary	133-5673		
Fuel Secondary	1R-0762		
Hydraulic	093-7521		
Hydraulic	126-2081	126-2131	
Hydraulic	4I-3948	126-1813	
Air Primary	106-3969		
Air Secondary	106-3973		
345B Excavator			2SW1-UP
Engine Oil	1R-0716		
Fuel Primary	133-5673		
Fuel Secondary	1R-0762		
Hydraulic	093-7521		
Hydraulic	126-2081	126-2131	
Hydraulic	146-9290		
Hydraulic	4I-3948	126-1813	
Air Primary	142-1340		
Air Secondary	142-1403		

FILTER TYPE	PART NUMBER	HIGH EFFICIENCY	FIRE RESISTANT
345B Excavator			2ZW1-UP
Engine Oil	1R-0716		
Fuel Primary	133-5673		
Fuel Secondary	1R-0762		
Hydraulic	093-7521		
Hydraulic	126-2081	126-2131	
Hydraulic	4I-3948	126-1813	
Air Primary	142-1340		
Air Secondary	142-1403		
345B Excavator			3MW1-UP
Engine Oil	1R-0716		
Fuel Primary	133-5673		
Fuel Secondary	1R-0762		
Hydraulic	093-7521		
Hydraulic	126-2081	126-2131	
Hydraulic	4I-3948	126-1813	
Air Primary	142-1340		
Air Secondary	142-1403		
345B Excavator			4SS1-UP
Engine Oil	1R-0716		
Fuel Primary	133-5673		
Fuel Secondary	1R-0762		
Hydraulic	093-7521		
Hydraulic	126-2081	126-2131	
Hydraulic	4I-3948	126-1813	
Air Primary	106-3969		
Air Secondary	106-3973		
345B Excavator			7KS1-UP
Engine Oil	1R-0716		
Fuel Primary	133-5673		
Fuel Secondary	1R-0762		
Hydraulic	093-7521		
Hydraulic	126-2081	126-2131	
Hydraulic	146-9290		
Hydraulic	4I-3948	126-1813	
Air Primary	142-1340		
Air Secondary	142-1403		
345B Excavator			9GS1-UP
Engine Oil	1R-0716		
Fuel Primary	133-5673		
Fuel Secondary	1R-0762		
Hydraulic	093-7521		
Hydraulic	126-2081	126-2131	
Hydraulic	4I-3948	126-1813	
Air Primary	106-3969		
Air Secondary	106-3973		
345B Excavator			AKJ1-UP
Engine Oil	1R-0716		

a - For quantities, refer to parts book.

Filters - Excavators

FILTER TYPE	PART NUMBER	HIGH EFFICIENCY	FIRE RESISTANT
345B Excavator (cont.)			AKJ1-UP
Fuel Primary	133-5673		
Fuel Secondary	1R-0762		
Hydraulic	093-7521		
Hydraulic	126-2081	126-2131	
Hydraulic	179-9806		
Hydraulic	4I-3948	126-1813	
Air Primary	106-3969		
Air Secondary	106-3973		
345B Excavator			AKX1-UP
Engine Oil	1R-0716		
Fuel Primary	133-5673		
Fuel Secondary	1R-0762		
Hydraulic	093-7521		
Hydraulic	126-2081	126-2131	
Hydraulic	179-9806		
Hydraulic	4I-3948	126-1813	
Air Primary	106-3969		
Air Secondary	106-3973		
345B Excavator			ALD1-UP
Engine Oil	1R-0716		
Fuel Primary	133-5673		
Fuel Secondary	1R-0762		
Hydraulic	093-7521		
Hydraulic	126-2081	126-2131	
Hydraulic	179-9806		
Hydraulic	4I-3948	126-1813	
Air Primary	106-3969		
Air Secondary	106-3973		
345B Excavator			BFG1-UP
Engine Oil	1R-0716		
Fuel Primary	133-5673		
Fuel Secondary	1R-0762		
Hydraulic	093-7521		
Hydraulic	126-2081	126-2131	
Hydraulic	4I-3948	126-1813	
Air Primary	142-1340		
Air Secondary	142-1403		
345B Series II Excavator			CCC1-UP
Engine Oil	1R-0716		
Fuel Primary	133-5673		
Fuel Secondary	1R-0762		
Hydraulic	146-9290		
Air Primary	142-1340		
Air Secondary	142-1403		
345B L Excavator			2SW1-UP
Engine Oil	1R-0716		
Fuel Primary	133-5673		

FILTER TYPE	PART NUMBER	HIGH EFFICIENCY	FIRE RESISTANT
345B L Excavator (cont.)			2SW1-UP
Fuel Secondary	1R-0762		
Hydraulic	093-7521		
Hydraulic	126-2081	126-2131	
Hydraulic	146-9290		
Hydraulic	4I-3948	126-1813	
Air Primary	142-1340		
Air Secondary	142-1403		
345B L Excavator			2ZW1-UP
Engine Oil	1R-0716		
Fuel Primary	133-5673		
Fuel Secondary	1R-0762		
Hydraulic	093-7521		
Hydraulic	126-2081	126-2131	
Hydraulic	4I-3948	126-1813	
Air Primary	142-1340		
Air Secondary	142-1403		
345B L Excavator			3MW1-UP
Engine Oil	1R-0716		
Fuel Primary	133-5673		
Fuel Secondary	1R-0762		
Hydraulic	093-7521		
Hydraulic	126-2081	126-2131	
Hydraulic	4I-3948	126-1813	
Air Primary	142-1340		
Air Secondary	142-1403		
345B L Excavator			4SS1-UP
Engine Oil	1R-0716		
Fuel Primary	133-5673		
Fuel Secondary	1R-0762		
Hydraulic	093-7521		
Hydraulic	126-2081	126-2131	
Hydraulic	4I-3948	126-1813	
Air Primary	106-3969		
Air Secondary	106-3973		
345B L Excavator			5WS1-UP
Engine Oil	1R-0716		
Fuel Primary	133-5673		
Fuel Secondary	1R-0762		
Hydraulic	093-7521		
Hydraulic	126-2081	126-2131	
Hydraulic	4I-3948	126-1813	
Air Primary	106-3969		
Air Primary	142-1340		
Air Secondary	106-3973		
Air Secondary	142-1403		
345B L Excavator			6XS1-UP
Engine Oil	1R-0716		

a - For quantities, refer to parts book.

Filters - Excavators

FILTER TYPE	PART NUMBER	HIGH EFFICIENCY	FIRE RESISTANT
345B L Excavator (cont.)			6XS1-UP
Fuel Primary	133-5673		
Fuel Secondary	1R-0762		
Hydraulic	093-7521		
Hydraulic	126-2081	126-2131	
Hydraulic	4I-3948	126-1813	
Air Primary	142-1340		
Air Secondary	142-1403		
345B L Excavator			7KS1-UP
Engine Oil	1R-0716		
Fuel Primary	133-5673		
Fuel Secondary	1R-0762		
Hydraulic	093-7521		
Hydraulic	126-2081	126-2131	
Hydraulic	146-9290		
Hydraulic	4I-3948	126-1813	
Air Primary	142-1340		
Air Secondary	142-1403		
345B L Excavator			9GS1-UP
Engine Oil	1R-0716		
Fuel Primary	133-5673		
Fuel Secondary	1R-0762		
Hydraulic	093-7521		
Hydraulic	126-2081	126-2131	
Hydraulic	4I-3948	126-1813	
Air Primary	106-3969		
Air Secondary	106-3973		
345B L Excavator			BFG1-UP
Engine Oil	1R-0716		
Fuel Primary	133-5673		
Fuel Secondary	1R-0762		
Hydraulic	093-7521		
Hydraulic	126-2081	126-2131	
Hydraulic	4I-3948	126-1813	
Air Primary	142-1340		
Air Secondary	142-1403		
345B L Series II Excavator			AGS1-UP
Engine Oil	1R-0716		
Fuel Primary	133-5673		
Fuel Secondary	1R-0762		
Hydraulic	093-7521		
Hydraulic	126-2081	126-2131	
Hydraulic	4I-3948	126-1813	
Air Primary	106-3969		
Air Secondary	106-3973		
345B L Series II Excavator			ALB1-UP
Engine Oil	1R-0716		
Fuel Primary	133-5673		

FILTER TYPE	PART NUMBER	HIGH EFFICIENCY	FIRE RESISTANT
345B L Series II Excavator (cont.)			ALB1-UP
Fuel Secondary	1R-0762		
Hydraulic	093-7521		
Hydraulic	126-2081	126-2131	
Hydraulic	4I-3948	126-1813	
Air Primary	106-3969		
Air Secondary	106-3973		
345B L Series II Excavator			AKJ1-UP
Engine Oil	1R-0716		
Fuel Primary	133-5673		
Fuel Secondary	1R-0762		
Hydraulic	093-7521		
Hydraulic	126-2081	126-2131	
Hydraulic	179-9806		
Hydraulic	4I-3948	126-1813	
Air Primary	106-3969		
Air Secondary	106-3973		
345B L Series II Excavator			AKX1-UP
Engine Oil	1R-0716		
Fuel Primary	133-5673		
Fuel Secondary	1R-0762		
Hydraulic	093-7521		
Hydraulic	126-2081	126-2131	
Hydraulic	179-9806		
Hydraulic	4I-3948	126-1813	
Air Primary	106-3969		
Air Secondary	106-3973		
345B L Series II Excavator			ALD1-UP
Engine Oil	1R-0716		
Fuel Primary	133-5673		
Fuel Secondary	1R-0762		
Hydraulic	093-7521		
Hydraulic	126-2081	126-2131	
Hydraulic	179-9806		
Hydraulic	4I-3948	126-1813	
Air Primary	106-3969		
Air Secondary	106-3973		
345B LC Excavator			2SW1-UP
Engine Oil	1R-0716		
Fuel Primary	133-5673		
Fuel Secondary	1R-0762		
Hydraulic	093-7521		
Hydraulic	126-2081	126-2131	
Hydraulic	146-9290		
Hydraulic	4I-3948	126-1813	
Air Primary	142-1340		
Air Secondary	142-1403		

a - For quantities, refer to parts book.

Filters - Excavators

FILTER TYPE	PART NUMBER	HIGH EFFICIENCY	FIRE RESISTANT
345B LC Excavator			7KS1-UP
Engine Oil	1R-0716		
Fuel Primary	133-5673		
Fuel Secondary	1R-0762		
Hydraulic	093-7521		
Hydraulic	126-2081	126-2131	
Hydraulic	146-9290		
Hydraulic	4I-3948	126-1813	
Air Primary	142-1340		
Air Secondary	142-1403		
345B LC Excavator			BFG1-UP
Engine Oil	1R-0716		
Fuel Primary	133-5673		
Fuel Secondary	1R-0762		
Hydraulic	093-7521		
Hydraulic	126-2081	126-2131	
Hydraulic	4I-3948	126-1813	
Air Primary	142-1340		
Air Secondary	142-1403		
350 Excavator			2ZL1-UP
Engine Oil	1R-0716		
Fuel Primary	9M-2341		
Fuel Secondary	1R-0750		
Hydraulic	094-4412	139-1540	
Hydraulic	4I-3950	126-1814	
Hydraulic	4T-6788	144-0832	
Air Primary	106-3969		
Air Secondary	106-3973		
350 Excavator			3ML1-UP
Engine Oil	1R-0716		
Fuel Primary	9M-2341		
Fuel Secondary	1R-0750		
Hydraulic	094-4412	139-1540	
Hydraulic	4I-3950	126-1814	
Hydraulic	4T-6788	144-0832	
Air Primary	106-3969		
Air Secondary	106-3973		
350 Excavator			7RK1-UP
Engine Oil	1R-0716		
Fuel Primary	9M-2341		
Fuel Secondary	1R-0750		
Hydraulic	094-4412	139-1540	
Hydraulic	4I-3950	126-1814	
Hydraulic	4T-6788	144-0832	
Air Primary	102-3765		
Air Primary	106-3969		
Air Secondary	102-3764		
Air Secondary	106-3973		

FILTER TYPE	PART NUMBER	HIGH EFFICIENCY	FIRE RESISTANT
350 Excavator			8HK1-UP
Engine Oil	1R-0716		
Fuel Primary	9M-2341		
Fuel Secondary	1R-0750		
Hydraulic	094-4412	139-1540	
Hydraulic	4I-3950	126-1814	
Hydraulic	4T-6788	144-0832	
Air Primary	106-3969		
Air Secondary	106-3973		
350 Excavator			9DK1-UP
Engine Oil	1R-0716		
Fuel Primary	9M-2341		
Fuel Secondary	1R-0750		
Hydraulic	094-4412	139-1540	
Hydraulic	4I-3950	126-1814	
Hydraulic	4T-6788	144-0832	
Air Primary	102-3765		
Air Primary	106-3969		
Air Primary	7W-9853		
Air Secondary	102-3764		
Air Secondary	106-3973		
Air Secondary	7W-9567		
350 Excavator			9FL1-UP
Engine Oil	1R-0716		
Fuel Primary	9M-2341		
Fuel Secondary	1R-0750		
Hydraulic	094-4412	139-1540	
Hydraulic	4I-3950	126-1814	
Hydraulic	4T-6788	144-0832	
Air Primary	106-3969		
Air Secondary	106-3973		
350 L Excavator			2ZL1-UP
Engine Oil	1R-0716		
Fuel Primary	9M-2341		
Fuel Secondary	1R-0750		
Hydraulic	094-4412	139-1540	
Hydraulic	4I-3950	126-1814	
Hydraulic	4T-6788	144-0832	
Air Primary	106-3969		
Air Secondary	106-3973		
350 L Excavator			3ML1-UP
Engine Oil	1R-0716		
Fuel Primary	9M-2341		
Fuel Secondary	1R-0750		
Hydraulic	094-4412	139-1540	
Hydraulic	4I-3950	126-1814	
Hydraulic	4T-6788	144-0832	
Air Primary	106-3969		
Air Secondary	106-3973		

a - For quantities, refer to parts book.

Filters - Excavators

FILTER TYPE	PART NUMBER	HIGH EFFICIENCY	FIRE RESISTANT
350 L Excavator			7RK1-UP
Engine Oil	1R-0716		
Fuel Primary	9M-2341		
Fuel Secondary	1R-0750		
Hydraulic	094-4412	139-1540	
Hydraulic	4I-3950	126-1814	
Hydraulic	4T-6788	144-0832	
Air Primary	102-3765		
Air Primary	106-3969		
Air Secondary	102-3764		
Air Secondary	106-3973		
350 L Excavator			8HK1-UP
Engine Oil	1R-0716		
Fuel Primary	9M-2341		
Fuel Secondary	1R-0750		
Hydraulic	094-4412	139-1540	
Hydraulic	4I-3950	126-1814	
Hydraulic	4T-6788	144-0832	
Air Primary	106-3969		
Air Secondary	106-3973		
350 L Excavator			9DK1-UP
Engine Oil	1R-0716		
Fuel Primary	9M-2341		
Fuel Secondary	1R-0750		
Hydraulic	094-4412	139-1540	
Hydraulic	4I-3950	126-1814	
Hydraulic	4T-6788	144-0832	
Air Primary	102-3765		
Air Primary	106-3969		
Air Primary	7W-9853		
Air Secondary	102-3764		
Air Secondary	106-3973		
Air Secondary	7W-9567		
350 L Excavator			9FL1-UP
Engine Oil	1R-0716		
Fuel Primary	9M-2341		
Fuel Secondary	1R-0750		
Hydraulic	094-4412	139-1540	
Hydraulic	4I-3950	126-1814	
Hydraulic	4T-6788	144-0832	
Air Primary	106-3969		
Air Secondary	106-3973		
365B L Excavator			9PZ1-UP
Engine Oil	1R-0716		
Fuel Primary	133-5673		
Fuel Secondary	1R-0762		
Hydraulic	126-2081	126-2131	
Hydraulic	146-9290		

FILTER TYPE	PART NUMBER	HIGH EFFICIENCY	FIRE RESISTANT
365B L Excavator (cont.)			9PZ1-UP
Hydraulic	185-0337	126-1814	
Hydraulic	4T-6788	144-0832	
Air Primary	106-3969		
Air Secondary	106-3973		
365B L Excavator			9TZ1-UP
Engine Oil	1R-0716		
Fuel Primary	133-5673		
Fuel Secondary	1R-0762		
Hydraulic	126-2081	126-2131	
Hydraulic	146-9290		
Hydraulic	185-0337	126-1814	
Hydraulic	4T-6788	144-0832	
Air Primary	106-3969		
Air Secondary	106-3973		
365B L Excavator			AGD1-UP
Engine Oil	1R-0716		
Fuel Primary	133-5673		
Fuel Secondary	1R-0762		
Hydraulic	126-2081	126-2131	
Hydraulic	143-8086		
Hydraulic	4I-3950	126-1814	
Hydraulic	4T-6788	144-0832	
Air Primary	106-3969		
Air Secondary	106-3973		
375 Excavator			1JM1-UP
Engine Oil	1R-0716		
Fuel Primary	9M-2341		
Fuel Secondary	1R-0749		
Hydraulic	094-4412	139-1540	
Hydraulic	4I-3950	126-1814	
Hydraulic	4T-6788	144-0832	
Air Primary	4W-5228		
Air Secondary	1N-4864		
375 Excavator			6NK1-UP
Engine Oil	1R-0716		
Fuel Primary	9M-2341		
Fuel Secondary	1R-0749		
Hydraulic	094-4412	139-1540	
Hydraulic	159-1427		
Hydraulic	159-1428		
Hydraulic	4I-3950	126-1814	
Hydraulic	4T-6788	144-0832	
Air Primary	4W-5228		
Air Secondary	1N-4864		
375 Excavator			6RL1-UP
Engine Oil	1R-0716		
Fuel Primary	9M-2341		

a - For quantities, refer to parts book.

Filters - Excavators

FILTER TYPE	PART NUMBER	HIGH EFFICIENCY	FIRE RESISTANT
375 Excavator (cont.)			6RL1-UP
Fuel Secondary	1R-0749		
Hydraulic	094-4412	139-1540	
Hydraulic	4I-3950	126-1814	
Hydraulic	4T-6788	144-0832	
Air Primary	4W-5228		
Air Primary	7Y-1196		
Air Secondary	1N-4864		
Air Secondary	7Y-1197		
375 Excavator			8WJ1-UP
Engine Oil	1R-0716		
Fuel Primary	9M-2341		
Fuel Secondary	1R-0749		
Hydraulic	094-4412	139-1540	
Hydraulic	4I-3950	126-1814	
Hydraulic	4T-6788	144-0832	
Air Primary	4W-5228		
Air Primary	7Y-1196		
Air Secondary	1N-4864		
Air Secondary	7Y-1197		
375 Excavator			8XG1-312
Engine Oil	1R-0716		
Fuel Primary	9M-2341		
Fuel Secondary	1R-0749		
Hydraulic	094-4412	139-1540	
Hydraulic	4I-3950	126-1814	
Hydraulic	4T-6788	144-0832	
Air Primary	4W-5228		
Air Secondary	1N-4864		
375 Excavator			8XG313-UP
Engine Oil	1R-0716		
Fuel Primary	9M-2341		
Fuel Secondary	1R-0749		
Hydraulic	094-4412	139-1540	
Hydraulic	4I-3950	126-1814	
Hydraulic	4T-6788	144-0832	
Air Primary	7Y-1196		
Air Secondary	7Y-1197		
375 Excavator			9WL1-UP
Engine Oil	1R-0716		
Fuel Primary	9M-2341		
Fuel Secondary	1R-0749		
Hydraulic	094-4412	139-1540	
Hydraulic	159-1427		
Hydraulic	159-1428		
Hydraulic	4I-3950	126-1814	
Hydraulic	4T-6788	144-0832	
Air Primary	4W-5228		

FILTER TYPE	PART NUMBER	HIGH EFFICIENCY	FIRE RESISTANT
375 Excavator (cont.)			9WL1-UP
Air Secondary	1N-4864		
375L Excavator			1JM1-UP
Engine Oil	1R-0716		
Fuel Primary	9M-2341		
Fuel Secondary	1R-0749		
Hydraulic	094-4412	139-1540	
Hydraulic	4I-3950	126-1814	
Hydraulic	4T-6788	144-0832	
Air Primary	4W-5228		
Air Secondary	1N-4864		
375L Excavator			6NK1-UP
Engine Oil	1R-0716		
Fuel Primary	9M-2341		
Fuel Secondary	1R-0749		
Hydraulic	094-4412	139-1540	
Hydraulic	159-1427		
Hydraulic	159-1428		
Hydraulic	4I-3950	126-1814	
Hydraulic	4T-6788	144-0832	
Air Primary	4W-5228		
Air Secondary	1N-4864		
375L Excavator			6RL1-UP
Engine Oil	1R-0716		
Fuel Primary	9M-2341		
Fuel Secondary	1R-0749		
Hydraulic	094-4412	139-1540	
Hydraulic	4I-3950	126-1814	
Hydraulic	4T-6788	144-0832	
Air Primary	4W-5228		
Air Primary	7Y-1196		
Air Secondary	1N-4864		
Air Secondary	7Y-1197		
375L Excavator			8WJ1-UP
Engine Oil	1R-0716		
Fuel Primary	9M-2341		
Fuel Secondary	1R-0749		
Hydraulic	094-4412	139-1540	
Hydraulic	4I-3950	126-1814	
Hydraulic	4T-6788	144-0832	
Air Primary	4W-5228		
Air Primary	7Y-1196		
Air Secondary	1N-4864		
Air Secondary	7Y-1197		
375L Excavator			8XG1-312
Engine Oil	1R-0716		
Fuel Primary	9M-2341		
Fuel Secondary	1R-0749		

a - For quantities, refer to parts book.

Filters - Excavators

FILTER TYPE	PART NUMBER	HIGH EFFICIENCY	FIRE RESISTANT
375L Excavator (cont.)			8XG1-312
Hydraulic	094-4412	139-1540	
Hydraulic	4I-3950	126-1814	
Hydraulic	4T-6788	144-0832	
Air Primary	4W-5228		
Air Secondary	1N-4864		
375L Excavator			8XG313-UP
Engine Oil	1R-0716		
Fuel Primary	9M-2341		
Fuel Secondary	1R-0749		
Hydraulic	094-4412	139-1540	
Hydraulic	4I-3950	126-1814	
Hydraulic	4T-6788	144-0832	
Air Primary	7Y-1196		
Air Secondary	7Y-1197		
375L Excavator			9WL1-UP
Engine Oil	1R-0716		
Fuel Primary	9M-2341		
Fuel Secondary	1R-0749		
Hydraulic	094-4412	139-1540	
Hydraulic	159-1427		
Hydraulic	159-1428		
Hydraulic	4I-3950	126-1814	
Hydraulic	4T-6788	144-0832	
Air Primary	4W-5228		
Air Secondary	1N-4864		
385B Excavator			ANS1-UP
Engine Oil	1R-0716		
Fuel Primary	133-5673		
Fuel Secondary	1R-0762		
Hydraulic	126-2081	126-2131	
Hydraulic	4T-6788	144-0832	
Air Primary	106-3969		
Air Secondary	106-3973		
385B Excavator			CKB1-UP
Engine Oil	1R-0716		
Fuel Primary	133-5673		
Fuel Secondary	1R-0762		
Hydraulic	126-2081	126-2131	
Hydraulic	4T-6788	144-0832	
Air Primary	106-3969		
Air Secondary	106-3973		
385B Excavator			CLS1-UP
Engine Oil	1R-0716		
Fuel Primary	133-5673		
Fuel Secondary	1R-0762		
Hydraulic	146-9290		
Hydraulic	185-0337	126-1814	

FILTER TYPE	PART NUMBER	HIGH EFFICIENCY	FIRE RESISTANT
385B Excavator (cont.)			CLS1-UP
Hydraulic	4T-6788	144-0832	
Air Primary	106-3969		
Air Secondary	106-3973		
385B Excavator			FDL1-UP
Engine Oil	1R-0716		
Fuel Primary	133-5673		
Fuel Secondary	1R-0762		
Hydraulic	146-9290		
Hydraulic	4T-6788	144-0832	
Air Primary	106-3969		
Air Secondary	106-3973		
385B L Excavator			ANS1-UP
Engine Oil	1R-0716		
Fuel Primary	133-5673		
Fuel Secondary	1R-0762		
Hydraulic	126-2081	126-2131	
Hydraulic	4T-6788	144-0832	
Air Primary	106-3969		
Air Secondary	106-3973		
385B L Excavator			CKB1-UP
Engine Oil	1R-0716		
Fuel Primary	133-5673		
Fuel Secondary	1R-0762		
Hydraulic	126-2081	126-2131	
Hydraulic	4T-6788	144-0832	
Air Primary	106-3969		
Air Secondary	106-3973		
385B L Excavator			CLS1-UP
Engine Oil	1R-0716		
Fuel Primary	133-5673		
Fuel Secondary	1R-0762		
Hydraulic	146-9290		
Hydraulic	185-0337	126-1814	
Hydraulic	4T-6788	144-0832	
Air Primary	106-3969		
Air Secondary	106-3973		
385B L Excavator			FDL1-UP
Engine Oil	1R-0716		
Fuel Primary	133-5673		
Fuel Secondary	1R-0762		
Hydraulic	146-9290		
Hydraulic	4T-6788	144-0832	
Air Primary	106-3969		
Air Secondary	106-3973		
E110B Excavator			8MF1-UP
Engine Oil	1R-0714		
Fuel Primary	9M-2341		

a - For quantities, refer to parts book.

Filters - Excavators

FILTER TYPE	PART NUMBER	HIGH EFFICIENCY	FIRE RESISTANT
E110B Excavator (cont.)			8MF1-UP
Fuel Secondary	1R-0751		
Air Primary	4I-7575		
E120B Excavator			6JF1-UP
Engine Oil	1R-0714		
Fuel Primary	9M-2341		
Fuel Secondary	1R-0751		
Air Primary	4I-7575		
E180 Excavator			1RF1-UP
Engine Oil	1R-0714		
Fuel Secondary	1R-0750		
Hydraulic	094-4412	139-1540	
Air Primary	7W-5389		
Air Secondary	2S-1285		
E180 Excavator			4EF1-UP
Engine Oil	1R-0714		
Fuel Secondary	1R-0750		
Hydraulic	094-4412	139-1540	
Air Primary	7W-5389		
Air Secondary	2S-1285		
EL180 Excavator			1RF1-UP
Engine Oil	1R-0714		
Fuel Secondary	1R-0750		
Hydraulic	094-4412	139-1540	
Air Primary	7W-5389		
Air Secondary	2S-1285		
EL180 Excavator			4EF1-UP
Engine Oil	1R-0714		
Fuel Secondary	1R-0750		
Hydraulic	094-4412	139-1540	
Air Primary	7W-5389		
Air Secondary	2S-1285		
E200B Excavator			6KF1-UP
Engine Oil	1R-0739		
Fuel Primary	9M-2341		
Fuel Secondary	1R-0750		
Fuel Secondary	1R-0751		
Hydraulic	094-4412	139-1540	
Air Primary	4I-7575		
Air Primary	7Y-0404		
Air Secondary	5I-5208		
E200B Excavator			7DF1-UP
Engine Oil	1R-0739		
Fuel Primary	9M-2341		
Fuel Secondary	1R-0751		
Hydraulic	094-4412	139-1540	
Air Primary	4I-7575		
Air Primary	7Y-0404		

FILTER TYPE	PART NUMBER	HIGH EFFICIENCY	FIRE RESISTANT
E200B Excavator (cont.)			7DF1-UP
Air Secondary	5I-5208		
EL200B Excavator			6KF1-UP
Engine Oil	1R-0739		
Fuel Primary	9M-2341		
Fuel Secondary	1R-0750		
Fuel Secondary	1R-0751		
Hydraulic	094-4412	139-1540	
Air Primary	4I-7575		
Air Primary	7Y-0404		
Air Secondary	5I-5208		
EL200B Excavator			7DF1-UP
Engine Oil	1R-0739		
Fuel Primary	9M-2341		
Fuel Secondary	1R-0751		
Hydraulic	094-4412	139-1540	
Air Primary	4I-7575		
Air Primary	7Y-0404		
Air Secondary	5I-5208		
E240 Excavator			1FG1-UP
Engine Oil	1R-0739		
Fuel Secondary	1R-0750		
Hydraulic	094-4412	139-1540	
Air Primary	7W-5317		
Air Secondary	2S-1286		
E240 Excavator			4JF1-UP
Engine Oil	1R-0739		
Fuel Secondary	1R-0750		
Hydraulic	094-4412	139-1540	
Air Primary	7W-5317		
Air Secondary	2S-1286		
EL240 Excavator			1FG1-UP
Engine Oil	1R-0739		
Fuel Secondary	1R-0750		
Hydraulic	094-4412	139-1540	
Air Primary	7W-5317		
Air Secondary	2S-1286		
EL240 Excavator			4JF1-UP
Engine Oil	1R-0739		
Fuel Secondary	1R-0750		
Hydraulic	094-4412	139-1540	
Air Primary	7W-5317		
Air Secondary	2S-1286		
E240B Excavator			5WG1-UP
Engine Oil	1R-0739		
Fuel Primary	9M-2341		
Fuel Secondary	1R-0751		
Hydraulic	094-4412	139-1540	

a - For quantities, refer to parts book.

Filters - Excavators

FILTER TYPE	PART NUMBER	HIGH EFFICIENCY	FIRE RESISTANT
E240B Excavator			8SF1-UP
Engine Oil	1R-0739		
Fuel Primary	9M-2341		
Fuel Secondary	1R-0751		
Hydraulic	094-4412	139-1540	
EL240B Excavator			5WG1-UP
Engine Oil	1R-0739		
Fuel Primary	9M-2341		
Fuel Secondary	1R-0751		
Hydraulic	094-4412	139-1540	
EL240B Excavator			8SF1-UP
Engine Oil	1R-0739		
Fuel Primary	9M-2341		
Fuel Secondary	1R-0751		
Hydraulic	094-4412	139-1540	
E240C Excavator			2RL1-UP
Engine Oil	1R-0739		
Fuel Primary	9M-2341		
Fuel Secondary	1R-0751		
Hydraulic	094-4412	139-1540	
E240C Excavator			9PK1-UP
Engine Oil	1R-0739		
Fuel Primary	9M-2341		
Fuel Secondary	1R-0751		
Hydraulic	094-4412	139-1540	
EL240C Excavator			2RL1-UP
Engine Oil	1R-0739		
Fuel Primary	9M-2341		
Fuel Secondary	1R-0751		
Hydraulic	094-4412	139-1540	
EL240C Excavator			9PK1-UP
Engine Oil	1R-0739		
Fuel Primary	9M-2341		
Fuel Secondary	1R-0751		
Hydraulic	094-4412	139-1540	
E300 Excavator			2CF1-UP
Engine Oil	1R-0739		
Fuel Secondary	1R-0750		
Hydraulic	094-4412	139-1540	
Air Primary	7W-5317		
Air Secondary	2S-1286		
E300 Excavator			4NF1-UP
Engine Oil	1R-0739		
Fuel Secondary	1R-0750		
Hydraulic	094-4412	139-1540	
Air Primary	7W-5317		
Air Secondary	2S-1286		

FILTER TYPE	PART NUMBER	HIGH EFFICIENCY	FIRE RESISTANT
EL300 Excavator			2CF1-UP
Engine Oil	1R-0739		
Fuel Secondary	1R-0750		
Hydraulic	094-4412	139-1540	
Air Primary	7W-5317		
Air Secondary	2S-1286		
EL300 Excavator			4NF1-UP
Engine Oil	1R-0739		
Fuel Secondary	1R-0750		
Hydraulic	094-4412	139-1540	
Air Primary	7W-5317		
Air Secondary	2S-1286		
E300B Excavator			1WJ1-UP
Engine Oil	1R-0739		
Fuel Secondary	1R-0750		
Hydraulic	094-4412	139-1540	
Air Primary	099-5801		
Air Secondary	099-5800		
E300B Excavator			3FJ1-UP
Engine Oil	1R-0739		
Fuel Secondary	1R-0750		
Hydraulic	094-4412	139-1540	
Air Primary	099-5801		
Air Secondary	099-5800		
EL300B Excavator			1WJ1-UP
Engine Oil	1R-0739		
Fuel Secondary	1R-0750		
Hydraulic	094-4412	139-1540	
Air Primary	099-5801		
Air Secondary	099-5800		
EL300B Excavator			3FJ1-UP
Engine Oil	1R-0739		
Fuel Secondary	1R-0750		
Hydraulic	094-4412	139-1540	
Air Primary	099-5801		
Air Secondary	099-5800		
E450 Excavator			3HG1-UP
Hydraulic	094-4412	139-1540	
Hydraulic	094-4421		
Air Secondary	094-6081		
M312 Excavator			6TL1-409
Engine Oil	7W-2326		
Fuel Primary	138-3100		
Fuel Secondary	159-6102		
Hydraulic	109-7287	137-7249	
Hydraulic	109-7289		
Hydraulic	109-7293		
Air Primary	110-6326		
Air Secondary	110-6331		

a - For quantities, refer to parts book.

Filters - Excavators, Front-Shovel Excavators

FILTER TYPE	PART NUMBER	HIGH EFFICIENCY	FIRE RESISTANT
M312 Excavator		6TL410-UP	
Engine Oil	7W-2326		
Fuel Primary	138-3100		
Fuel Secondary	159-6102		
Hydraulic	109-7287	137-7249	
Hydraulic	109-7289		
Air Primary	110-6326		
Air Secondary	110-6331		
M315 Excavator		7ML1-859	
Engine Oil	7W-2326		
Fuel Primary	138-3100		
Fuel Secondary	159-6102		
Hydraulic	109-7287	137-7249	
Hydraulic	109-7289		
Hydraulic	109-7293		
Air Primary	110-6326		
Air Secondary	110-6331		
M315 Excavator		7ML860-UP	
Engine Oil	7W-2326		
Fuel Primary	138-3100		
Fuel Secondary	159-6102		
Hydraulic	109-7287	137-7249	
Hydraulic	109-7289		
Air Primary	110-6326		
Air Secondary	110-6331		
M318 Excavator		6ES1-UP	
Engine Oil	1R-0739		
Fuel Primary	117-4089		
Fuel Primary	151-2409		
Fuel Primary	9M-2341		
Fuel Secondary	1R-0751		
Hydraulic	109-7287	137-7249	
Hydraulic	109-7289		
Hydraulic	109-7293		
Air Primary	8T-7462		
Air Secondary	8T-7463		
M318 Excavator		8AL1-1019	
Engine Oil	1R-0739		
Fuel Primary	9M-2341		
Fuel Secondary	1R-0751		
Hydraulic	109-7287	137-7249	
Hydraulic	109-7289		
Hydraulic	109-7293		
Air Primary	8T-7462		
Air Secondary	8T-7463		
M318 Excavator		8AL1020-UP	
Engine Oil	1R-0739		
Fuel Primary	151-2409		

FILTER TYPE	PART NUMBER	HIGH EFFICIENCY	FIRE RESISTANT
M318 Excavator (cont.)		8AL1020-UP	
Fuel Secondary	1R-0751		
Hydraulic	109-7287	137-7249	
Hydraulic	109-7289		
Air Primary	8T-7462		
Air Secondary	8T-7463		
M318 Excavator		8SS1-UP	
Engine Oil	1R-0739		
Fuel Primary	117-4089		
Fuel Primary	151-2409		
Fuel Secondary	1R-0751		
Hydraulic	109-7287	137-7249	
Hydraulic	109-7289		
Air Primary	8T-7462		
Air Secondary	8T-7463		
M320 Excavator		6WL1-UP	
Engine Oil	1R-0739		
Fuel Primary	117-4089		
Fuel Primary	151-2409		
Fuel Secondary	1R-0751		
Hydraulic	109-7289		
Hydraulic	137-7249		
Air Primary	8T-7462		
Air Secondary	8T-7463		
M320 Excavator		9PS1-UP	
Engine Oil	1R-0739		
Fuel Primary	117-4089		
Fuel Primary	151-2409		
Fuel Secondary	1R-0751		
Hydraulic	109-7289		
Hydraulic	137-7249		
Air Primary	8T-7462		
Air Secondary	8T-7463		
W330B MH Excavator		AME1-UP	
Engine Oil	1R-0739		
Fuel Primary	9M-2341		
Fuel Secondary	1R-0750		
Hydraulic	093-7521		
Hydraulic	126-2081	126-2131	
Hydraulic	184-3931		
Air Primary	6I-2503		
Air Secondary	6I-2504		
FRONT-SHOVEL EXCAVATORS ^a			
5080 Front-Shovel Excavator		6XK1-UP	
Engine Oil	1R-0716		
Fuel Primary	9M-2341		
Fuel Secondary	1R-0749		
Hydraulic	094-4412	139-1540	

a - For quantities, refer to parts book.

Filters - Front-Shovel Excavators, Integrated Toolcarriers

FILTER TYPE	PART NUMBER	HIGH EFFICIENCY	FIRE RESISTANT
5080 Front-Shovel Excavator (cont.)			6XK1-UP
Hydraulic	4I-3950	126-1814	
Hydraulic	4T-6788	144-0832	
Air Primary	7Y-1196		
Air Secondary	7Y-1197		
5080 Front-Shovel Excavator			8SL1-UP
Engine Oil	1R-0716		
Fuel Primary	9M-2341		
Fuel Secondary	1R-0749		
Hydraulic	094-4412	139-1540	
Hydraulic	4I-3950	126-1814	
Hydraulic	4T-6788	144-0832	
Air Primary	7Y-1196		
Air Secondary	7Y-1197		
5090B Front-Shovel Excavator			CLD1-UP
Engine Oil	1R-0716		
Fuel Primary	133-5673		
Fuel Secondary	1R-0762		
Hydraulic	146-9290		
Hydraulic	185-0337	126-1814	
Hydraulic	4T-6788	144-0832	
Air Primary	106-3969		
Air Secondary	106-3973		
5110B Front-Shovel Excavator			AAA1-UP
Engine Oil	1R-0716		
Fuel Primary	129-0373		
Fuel Secondary	1R-0749		
Hydraulic	134-0964	4C-6860	
Hydraulic	1R-0722	139-1536	4T-3134
Hydraulic	4I-3950	126-1814	
Air Primary	6I-2505		
Air Secondary	6I-2506		
5130 Front-Shovel Excavator			5ZL1-UP
Engine Oil	2P-4005		
Fuel Primary	9M-2342		
Fuel Secondary	1R-0755		
Hydraulic	1R-0722	139-1536	4T-3134
Hydraulic	4I-3950	126-1814	
Air Primary	6I-2509		
Air Primary	7W-5216		
Air Secondary	6I-2510		
Air Secondary	7N-1308		
5130B Front-Shovel Excavator			4CS1-UP
Engine Oil	2P-4005		
Fuel Primary	9M-2342		
Fuel Secondary	1R-0755		
Hydraulic	134-0964	4C-6860	
Hydraulic	1R-0722	139-1536	4T-3134

FILTER TYPE	PART NUMBER	HIGH EFFICIENCY	FIRE RESISTANT
5130B Front-Shovel Excavator (cont.)			4CS1-UP
Hydraulic	4I-3950	126-1814	
Air Primary	6I-2509		
Air Secondary	6I-2510		
5230 Front-Shovel Excavator			7LL1-UP
Engine Oil	1R-0716		
Engine Oil	2P-4005		
Fuel Primary	9M-2342		
Fuel Secondary	1R-0755		
Hydraulic	1R-0722	139-1536	4T-3134
Hydraulic	1R-0735	139-1537	104-6931
Hydraulic	4I-3950	126-1814	
Air Primary	6I-2509		
Air Secondary	6I-2510		
INTEGRATED TOOLCARRIERS ^a			
IT12 Integrated Toolcarrier			2YC1-UP
Engine Oil	1R-0713		
Fuel Primary	9M-2341		
Fuel Secondary	1R-0710		
Fuel Secondary	1R-0750		
Hydraulic	1R-0719	132-8875	4T-3131
Air Primary	4N-0326		
Air Secondary	4N-0313		
IT12 Integrated Toolcarrier			4NC1-UP
Engine Oil	1R-0713		
Fuel Primary	9M-2341		
Fuel Secondary	1R-0710		
Fuel Secondary	1R-0750		
Hydraulic	1R-0719	132-8875	4T-3131
Power Train	1R-0746	126-1810	
Air Primary	4N-0326		
Air Secondary	4N-0313		
IT12B Integrated Toolcarrier			1KF1-819
Engine Oil	1R-0714		
Fuel Primary	9M-2341		
Fuel Secondary	1R-0751		
Hydraulic	1R-0735	139-1537	104-6931
Power Train	1G-8878	102-2828	156-0214
Air Primary	4I-7575		
Air Secondary	6I-6582		
IT12F Integrated Toolcarrier			1KF820-UP
Engine Oil	1R-0714		
Fuel Primary	9M-2341		
Fuel Secondary	1R-0751		
Hydraulic	1R-0735	139-1537	104-6931
Power Train	1G-8878	102-2828	156-0214
Power Train	9T-9054	9T-7656	
Air Primary	4I-7575		

a - For quantities, refer to parts book.

Filters - Integrated Toolcarriers

FILTER TYPE	PART NUMBER	HIGH EFFICIENCY	FIRE RESISTANT
IT12F Integrated Toolcarrier (cont.)			1KF820-UP
Air Secondary	6I-6582		
IT14B Integrated Toolcarrier			3NJ1-UP
Engine Oil	1R-0714		
Fuel Primary	9M-2341		
Fuel Secondary	1R-0750		
Hydraulic	1R-0735	139-1537	104-6931
Power Train	9T-9054	9T-7656	
Air Primary	7W-3920		
Air Secondary	7C-1062		
IT14F Integrated Toolcarrier			4EL1-UP
Engine Oil	1R-0714		
Fuel Primary	9M-2341		
Fuel Secondary	1R-0751		
Hydraulic	1R-0735	139-1537	104-6931
Power Train	1G-8878	102-2828	156-0214
Power Train	9T-9054	9T-7656	
Air Primary	4I-7575		
Air Secondary	6I-6582		
IT14G Integrated Toolcarrier			1WN1-659
Engine Oil	7W-2326		
Fuel Primary	131-1812		
Fuel Secondary	159-6102		
Hydraulic	1G-8878	102-2828	156-0214
Power Train	1G-8878	102-2828	156-0214
Air Primary	4I-7575		
Air Secondary	122-4550		
IT14G Integrated Toolcarrier			1WN660-UP
Engine Oil	7W-2326		
Fuel Primary	163-4465		
Fuel Secondary	159-6102		
Hydraulic	1G-8878	102-2828	156-0214
Power Train	1G-8878	102-2828	156-0214
Air Primary	110-6326		
Air Secondary	110-6331		
IT14G Integrated Toolcarrier			8ZM1-331
Engine Oil	7W-2326		
Fuel Primary	131-1812		
Fuel Secondary	159-6102		
Power Train	1G-8878	102-2828	156-0214
Air Primary	4I-7575		
Air Secondary	122-4550		
IT14G Integrated Toolcarrier			8ZM332-UP
Engine Oil	7W-2326		
Fuel Primary	163-4465		
Fuel Secondary	159-6102		
Power Train	1G-8878	102-2828	156-0214
Air Primary	110-6326		

FILTER TYPE	PART NUMBER	HIGH EFFICIENCY	FIRE RESISTANT
IT14G Integrated Toolcarrier (cont.)			8ZM332-UP
Air Secondary	110-6331		
IT18 Integrated Toolcarrier			7ZB1-UP
Engine Oil	1R-0714		
Fuel Primary	9M-2341		
Fuel Secondary	1R-0750		
Hydraulic	1R-0722	139-1536	4T-3134
Power Train	1R-0746	126-1810	
Air Primary	7W-5389		
Air Secondary	8N-4901		
IT18 Integrated Toolcarrier			9NB1-UP
Engine Oil	1R-0714		
Fuel Primary	9M-2341		
Fuel Secondary	1R-0750		
Hydraulic	1R-0722	139-1536	4T-3134
Power Train	1R-0746	126-1810	
Air Primary	7W-5389		
Air Secondary	8N-4901		
IT18B Integrated Toolcarrier			1DF1-UP
Engine Oil	1R-0714		
Fuel Primary	9M-2341		
Fuel Secondary	1R-0750		
Hydraulic	1R-0722	139-1536	4T-3134
Power Train	1R-0746	126-1810	
Air Primary	7W-5389		
Air Secondary	8N-4901		
IT18B Integrated Toolcarrier			2NJ340-UP
Engine Oil	1R-0714		
Fuel Primary	9M-2341		
Fuel Secondary	1R-0750		
Hydraulic	1R-0722	139-1536	4T-3134
Power Train	1R-0746	126-1810	
Air Primary	7W-5389		
Air Secondary	8N-4901		
IT18B Integrated Toolcarrier			4ZD1-UP
Engine Oil	1R-0714		
Fuel Primary	9M-2341		
Fuel Secondary	1R-0750		
Hydraulic	1R-0722	139-1536	4T-3134
Power Train	1R-0746	126-1810	
Air Primary	7W-5389		
Air Secondary	8N-4901		
IT18F Integrated Toolcarrier			5EJ1-UP
Engine Oil	1R-0714		
Fuel Primary	9M-2341		
Fuel Secondary	1R-0751		
Hydraulic	1R-0722	139-1536	4T-3134
Power Train	1G-8878	102-2828	156-0214

a - For quantities, refer to parts book.

Filters - Integrated Toolcarriers

FILTER TYPE	PART NUMBER	HIGH EFFICIENCY	FIRE RESISTANT
IT18F Integrated Toolcarrier (cont.)			5EJ1-UP
Air Primary	6I-2499		
Air Secondary	6I-2500		
IT18F Integrated Toolcarrier			6ZF1-UP
Engine Oil	1R-0714		
Fuel Primary	9M-2341		
Fuel Secondary	1R-0751		
Hydraulic	1R-0722	139-1536	4T-3134
Power Train	1G-8878	102-2828	156-0214
Air Primary	6I-2499		
Air Secondary	6I-2500		
IT24F Integrated Toolcarrier			4NN1-UP
Engine Oil	1R-0714		
Engine Oil	1R-0739		
Engine Oil	1W-8845		
Fuel Primary	117-4089		
Fuel Primary	151-2409		
Fuel Primary	9M-2341		
Fuel Secondary	1R-0751		
Hydraulic	1R-0722	139-1536	4T-3134
Power Train	1G-8878	102-2828	156-0214
Air Primary	6I-2499		
Air Secondary	6I-2500		
IT24F Integrated Toolcarrier			6KN1-UP
Engine Oil	1R-0714		
Engine Oil	1R-0739		
Fuel Secondary	1R-0751		
Hydraulic	1R-0722	139-1536	4T-3134
Power Train	1G-8878	102-2828	156-0214
Air Primary	6I-2499		
Air Secondary	6I-2500		
IT28 Integrated Toolcarrier			2KC1-UP
Engine Oil	1R-0714		
Fuel Primary	9M-2341		
Fuel Secondary	1R-0750		
Hydraulic	1R-0722	139-1536	4T-3134
Power Train	1R-0746	126-1810	
Air Primary	7W-5389		
Air Secondary	8N-4901		
IT28 Integrated Toolcarrier			8JB1-UP
Engine Oil	1R-0714		
Fuel Primary	9M-2341		
Fuel Secondary	1R-0750		
Hydraulic	1R-0722	139-1536	4T-3134
Power Train	1R-0746	126-1810	
Air Primary	7W-5389		
Air Secondary	8N-4901		

FILTER TYPE	PART NUMBER	HIGH EFFICIENCY	FIRE RESISTANT
IT28B Integrated Toolcarrier			1HF1-UP
Engine Oil	1R-0714		
Fuel Primary	9M-2341		
Fuel Secondary	1R-0750		
Hydraulic	1R-0722	139-1536	4T-3134
Power Train	1R-0746	126-1810	
Air Primary	7W-5389		
Air Secondary	8N-4901		
IT28B Integrated Toolcarrier			1JK430-UP
Engine Oil	1R-0714		
Fuel Primary	9M-2341		
Fuel Secondary	1R-0750		
Hydraulic	1R-0722	139-1536	4T-3134
Power Train	1R-0746	126-1810	
Air Primary	7W-5389		
Air Secondary	8N-4901		
IT28B Integrated Toolcarrier			5SD1302-UP
Engine Oil	1R-0714		
Fuel Primary	9M-2341		
Fuel Secondary	1R-0750		
Hydraulic	1R-0722	139-1536	4T-3134
Power Train	1R-0746	126-1810	
Air Primary	7W-5389		
Air Secondary	8N-4901		
IT28F Integrated Toolcarrier			1JL1-UP
Engine Oil	1R-0739		
Fuel Primary	9M-2341		
Fuel Secondary	1R-0751		
Hydraulic	1R-0722	139-1536	4T-3134
Power Train	1G-8878	102-2828	156-0214
Air Primary	6I-2499		
Air Secondary	6I-2500		
IT28F Integrated Toolcarrier			3CL1-1199
Engine Oil	1R-0739		
Fuel Primary	9M-2341		
Fuel Secondary	1R-0751		
Hydraulic	1R-0722	139-1536	4T-3134
Power Train	1G-8878	102-2828	156-0214
Air Primary	6I-2499		
Air Secondary	6I-2500		
IT28F Integrated Toolcarrier			3CL1200-UP
Engine Oil	1R-0739		
Fuel Primary	117-4089		
Fuel Secondary	1R-0751		
Hydraulic	1R-0722	139-1536	4T-3134
Power Train	1G-8878	102-2828	156-0214
Air Primary	6I-2499		
Air Secondary	6I-2500		

a - For quantities, refer to parts book.

Filters - Integrated Toolcarriers

FILTER TYPE	PART NUMBER	HIGH EFFICIENCY	FIRE RESISTANT
IT28G Integrated Toolcarrier		8CR1-UP	
Engine Oil	1R-0739		
Fuel Primary	117-4089		
Fuel Primary	151-2409		
Fuel Secondary	1R-0751		
Fuel Secondary	1R-0753		
Hydraulic	126-1818		
Power Train	1G-8878	102-2828	156-0214
Air Primary	6I-2499		
Air Secondary	6I-2500		
IT28G Integrated Toolcarrier		9AR1-UP	
Engine Oil	1R-0739		
Fuel Primary	117-4089		
Fuel Secondary	1R-0751		
Hydraulic	126-1818		
Hydraulic	1G-8878	102-2828	156-0214
Air Primary	6I-2499		
Air Secondary	6I-2500		
IT38F Integrated Toolcarrier		5DR1-270	
Engine Oil	1R-0739		
Fuel Primary	9M-2341		
Fuel Secondary	1R-0751		
Hydraulic	1R-0722	139-1536	4T-3134
Power Train	1G-8878	102-2828	156-0214
Air Primary	6I-2501		
Air Secondary	6I-2502		
IT38F Integrated Toolcarrier		5DR271-UP	
Engine Oil	1R-0739		
Fuel Primary	117-4089		
Fuel Secondary	1R-0751		
Fuel Secondary	1R-0753		
Hydraulic	1R-0722	139-1536	4T-3134
Power Train	1G-8878	102-2828	156-0214
Air Primary	6I-2501		
Air Secondary	6I-2502		
IT38F Integrated Toolcarrier		6FN1-UP	
Engine Oil	1R-0739		
Fuel Primary	117-4089		
Fuel Primary	9M-2341		
Fuel Secondary	1R-0751		
Fuel Secondary	1R-0753		
Hydraulic	1R-0722	139-1536	4T-3134
Power Train	1G-8878	102-2828	156-0214
Air Primary	6I-2501		
Air Secondary	6I-2502		
IT38G Integrated Toolcarrier		1CW1-328	
Engine Oil	1R-0739		
Fuel Primary	117-4089		

FILTER TYPE	PART NUMBER	HIGH EFFICIENCY	FIRE RESISTANT
IT38G Integrated Toolcarrier (cont.)		1CW1-328	
Fuel Secondary	1R-0751		
Fuel Secondary	1R-0753		
Hydraulic	157-3862		
Hydraulic	1R-0722	139-1536	4T-3134
Power Train	1G-8878	102-2828	156-0214
Air Primary	128-2686		
Air Secondary	6I-2502		
IT38G Integrated Toolcarrier		1CW329-UP	
Engine Oil	1R-0739		
Fuel Primary	151-2409		
Fuel Secondary	1R-0751		
Fuel Secondary	1R-0753		
Hydraulic	157-3862		
Hydraulic	1R-0722	139-1536	4T-3134
Power Train	1G-8878	102-2828	156-0214
Air Primary	128-2686		
Air Secondary	6I-2502		
IT38G Integrated Toolcarrier		7BS1-UP	
Engine Oil	1R-0739		
Fuel Primary	117-4089		
Fuel Primary	151-2409		
Fuel Secondary	1R-0751		
Fuel Secondary	1R-0753		
Hydraulic	1R-0722	139-1536	4T-3134
Power Train	1G-8878	102-2828	156-0214
Air Primary	6I-2501		
Air Secondary	6I-2502		
IT62G Integrated Toolcarrier		6PS1-UP	
Engine Oil	1R-0739		
Engine Oil	1W-8845		
Fuel Primary	151-2409		
Fuel Secondary	1R-0751		
Fuel Secondary	1R-0753		
Hydraulic	1G-8878	102-2828	156-0214
Air Primary	128-2686		
Air Secondary	6I-2502		
IT62G Integrated Toolcarrier		AKP1-UP	
Engine Oil	1R-0739		
Engine Oil	1W-8845		
Fuel Primary	151-2409		
Fuel Secondary	1R-0751		
Fuel Secondary	1R-0753		
Hydraulic	1G-8878	102-2828	156-0214
Air Primary	128-2686		
Air Secondary	6I-2502		

a - For quantities, refer to parts book.

Filters - Landfill Compactors, Motor Graders

FILTER TYPE	PART NUMBER	HIGH EFFICIENCY	FIRE RESISTANT
LANDFILL COMPACTORS ^a			
816B Landfill Compactor			
			15Z1-UP
Engine Oil	1R-0739		
Fuel Primary	9M-2341		
Fuel Secondary	1R-0750		
Hydraulic	1R-0722	139-1536	4T-3134
Power Train	1R-0719	132-8875	4T-3131
Air Primary	6I-2501		
Air Secondary	6I-2502		
826G Landfill Compactor			
			7LN1-UP
Engine Oil	1R-0716		
Fuel Primary	9M-2341		
Fuel Secondary	1R-0749		
Hydraulic	1R-0722	139-1536	4T-3134
Power Train	1R-0719	132-8875	4T-3131
Air Primary	6I-0273		
Air Primary	6I-2505		
Air Secondary	6I-0274		
Air Secondary	6I-2506		
836 Landfill Compactor			
			3RL1-UP
Engine Oil	1R-0716		
Fuel Primary	9M-2341		
Fuel Secondary	1R-0749		
Hydraulic	1R-0732	139-1535	4T-3133
Power Train	1R-0719	132-8875	4T-3131
Air Primary	7W-5313		
Air Secondary	1P-8482		
836 Landfill Compactor			
			7FR1-263
Engine Oil	1R-0716		
Fuel Primary	129-0373		
Fuel Secondary	1R-0749		
Hydraulic	1R-0732	139-1535	4T-3133
Power Train	1R-0719	132-8875	4T-3131
Air Primary	7W-5313		
Air Secondary	1P-8482		
836 Landfill Compactor			
			7FR264-UP
Engine Oil	1R-0716		
Fuel Primary	129-0373		
Fuel Secondary	1R-0749		
Hydraulic	1R-0732	139-1535	4T-3133
Power Train	1R-0719	132-8875	4T-3131
Air Primary	6I-2505		
Air Secondary	6I-2506		
836G Landfill Compactor			
			7MZ1-UP
Engine Oil	1R-0716		
Fuel Primary	129-0373		
Fuel Secondary	1R-0749		
Hydraulic	126-1817		

FILTER TYPE	PART NUMBER	HIGH EFFICIENCY	FIRE RESISTANT
836G Landfill Compactor (cont.)			
			7MZ1-UP
Hydraulic	1G-8878	102-2828	156-0214
Power Train	139-1535		
Air Primary	6I-2509		
Air Secondary	6I-2510		
MOTOR GRADERS ^a			
12G Motor Grader			
			3PL1-UP
Engine Oil	1R-0739		
Fuel Primary	9M-2341		
Fuel Secondary	1R-0750		
Power Train	1R-0719	132-8875	4T-3131
Air Primary	6I-2499		
Air Primary	7W-5389		
Air Secondary	6I-2500		
12G Motor Grader			
			3WC1-1066
Engine Oil	1R-0739		
Fuel Primary	9M-2341		
Fuel Secondary	1R-0750		
Power Train	1R-0719	132-8875	4T-3131
Power Train	1R-0773	132-8875	4T-3131
Air Primary	7W-5389		
Air Secondary	2S-1285		
12G Motor Grader			
			3WC1067-UP
Engine Oil	1R-0739		
Fuel Primary	9M-2341		
Fuel Secondary	1R-0750		
Power Train	1R-0719	132-8875	4T-3131
Air Primary	6I-2499		
Air Primary	7W-5389		
Air Secondary	6I-2500		
12H Motor Grader			
			2GS1-UP
Engine Oil	1R-0739		
Fuel Primary	9M-2341		
Fuel Secondary	1R-0750		
Hydraulic	1R-0774	139-1536	4T-3134
Power Train	1R-0773		
Air Primary	6I-0273		
Air Secondary	6I-0274		
12H Motor Grader			
			2LR1-UP
Engine Oil	1R-0739		
Fuel Primary	9M-2341		
Fuel Secondary	1R-0750		
Hydraulic	1R-0774	139-1536	4T-3134
Power Train	1R-0719	132-8875	4T-3131
Power Train	1R-0773		
Air Primary	6I-0273		
Air Secondary	6I-0274		

a - For quantities, refer to parts book.

Filters - Motor Graders

FILTER TYPE	PART NUMBER	HIGH EFFICIENCY	FIRE RESISTANT
12H Motor Grader		2WR1-UP	
Engine Oil	1R-0739		
Fuel Primary	9M-2341		
Fuel Secondary	1R-0750		
Hydraulic	1R-0774	139-1536	4T-3134
Power Train	1R-0719	132-8875	4T-3131
Air Primary	6I-0273		
Air Primary	6I-2499		
Air Secondary	6I-0274		
Air Secondary	6I-2500		
12H Motor Grader		4ER1-UP	
Engine Oil	1R-0739		
Fuel Primary	9M-2341		
Fuel Secondary	1R-0750		
Hydraulic	1R-0774	139-1536	4T-3134
Power Train	132-8875		
Power Train	1R-0773		
Power Train	4T-3131		
Air Primary	6I-2499		
Air Secondary	6I-2500		
12H Motor Grader		4XM1-UP	
Engine Oil	1R-0739		
Fuel Primary	9M-2341		
Fuel Secondary	1R-0750		
Hydraulic	1R-0774	139-1536	4T-3134
Power Train	1R-0719	132-8875	4T-3131
Power Train	1R-0773		
Air Primary	6I-0273		
Air Primary	6I-2499		
Air Secondary	6I-0274		
Air Secondary	6I-2500		
12H Motor Grader		5ZM1-UP	
Engine Oil	1R-0739		
Fuel Primary	9M-2341		
Fuel Secondary	1R-0750		
Hydraulic	1R-0774	139-1536	4T-3134
Power Train	1R-0719	132-8875	4T-3131
Power Train	1R-0773		
Air Primary	6I-2499		
Air Secondary	6I-2500		
12H Motor Grader		8MN1-UP	
Engine Oil	1R-0739		
Engine Oil	1R-0739		
Fuel Primary	9M-2341		
Fuel Secondary	1R-0750		
Hydraulic	1R-0774	139-1536	4T-3134
Power Train	132-8875		
Power Train	1R-0773		

FILTER TYPE	PART NUMBER	HIGH EFFICIENCY	FIRE RESISTANT
12H Motor Grader (cont.)		8MN1-UP	
Power Train	4T-3131		
Air Primary	6I-0273		
Air Primary	6I-2499		
Air Secondary	6I-0274		
Air Secondary	6I-2500		
14H Motor Grader		7WJ1-UP	
Engine Oil	1R-0739		
Fuel Primary	9M-2341		
Fuel Secondary	1R-0750		
Hydraulic	1R-0722	139-1536	4T-3134
Power Train	1R-0719	132-8875	4T-3131
Air Primary	6I-0273		
Air Secondary	6I-0274		
16H NA Motor Grader		6ZJ1-UP	
Engine Oil	1R-0716		
Fuel Primary	9M-2341		
Fuel Secondary	1R-0749		
Hydraulic	1R-0722	139-1536	4T-3134
Power Train	1R-0719	132-8875	4T-3131
Air Primary	6I-0273		
Air Secondary	6I-0274		
24H Motor Grader		7KK1-UP	
Engine Oil	1R-0716		
Fuel Primary	129-0373		
Fuel Secondary	1R-0749		
Hydraulic	1R-0722	139-1536	4T-3134
Power Train	1R-0741	132-8876	4T-3132
Power Train	4I-3950	126-1814	
Air Primary	106-3969		
Air Secondary	106-3973		
120B Motor Grader		32C100-UP	
Engine Oil	1R-0739		
Fuel Secondary	1R-0750		
Power Train	8B-5935		
Air Primary	7W-5317		
Air Secondary	2S-1286		
120G Motor Grader		4HD1-UP	
Engine Oil	1R-0739		
Fuel Primary	9M-2341		
Fuel Secondary	1R-0750		
Hydraulic	1R-0719	132-8875	4T-3131
Air Primary	6I-2499		
Air Primary	7W-5389		
Air Secondary	2S-1285		
Air Secondary	6I-2500		
120H Motor Grader		2AN1-UP	
Engine Oil	1R-0739		
Fuel Primary	117-4089		

a - For quantities, refer to parts book.

Filters - Motor Graders

FILTER TYPE	PART NUMBER	HIGH EFFICIENCY	FIRE RESISTANT
120H Motor Grader (cont.)		2AN1-UP	
Fuel Secondary	1R-0751		
Fuel Secondary	1R-0753		
Hydraulic	1R-0722	139-1536	4T-3134
Power Train	1R-0719	132-8875	4T-3131
Air Primary	6I-2499		
Air Secondary	6I-2500		
120H Motor Grader		4MK1-UP	
Engine Oil	1R-0739		
Fuel Primary	117-4089		
Fuel Secondary	1R-0751		
Fuel Secondary	1R-0753		
Hydraulic	1R-0722	139-1536	4T-3134
Power Train	1R-0719	132-8875	4T-3131
Air Primary	6I-2499		
Air Secondary	6I-2500		
120H Motor Grader		5FM1-UP	
Engine Oil	1R-0739		
Fuel Primary	117-4089		
Fuel Secondary	1R-0751		
Fuel Secondary	1R-0753		
Hydraulic	1R-0722	139-1536	4T-3134
Power Train	132-8875		
Power Train	1R-0773		
Power Train	4T-3131		
Air Primary	6I-2499		
Air Secondary	6I-2500		
120H Motor Grader		6NM1-UP	
Engine Oil	1R-0739		
Fuel Primary	117-4089		
Fuel Secondary	1R-0751		
Fuel Secondary	1R-0753		
Hydraulic	1R-0722	139-1536	4T-3134
Power Train	1R-0719	132-8875	4T-3131
Power Train	1R-0773		
Air Primary	6I-2499		
Air Secondary	6I-2500		
120H Motor Grader		6TM1-UP	
Engine Oil	1R-0739		
Fuel Primary	117-4089		
Fuel Secondary	1R-0751		
Fuel Secondary	1R-0753		
Hydraulic	1R-0722	139-1536	4T-3134
Power Train	1R-0719	132-8875	4T-3131
Power Train	1R-0773		
Air Primary	6I-2499		
Air Secondary	6I-2500		

FILTER TYPE	PART NUMBER	HIGH EFFICIENCY	FIRE RESISTANT
120H Motor Grader		6YN1-UP	
Engine Oil	1R-0739		
Fuel Primary	117-4089		
Fuel Secondary	1R-0751		
Fuel Secondary	1R-0753		
Hydraulic	1R-0722	139-1536	4T-3134
Power Train	132-8875		
Power Train	1R-0773		
Power Train	4T-3131		
Air Primary	6I-2499		
Air Secondary	6I-2500		
120H Motor Grader		9YR1-UP	
Engine Oil	1R-0739		
Fuel Primary	117-4089		
Fuel Secondary	1R-0751		
Fuel Secondary	1R-0753		
Hydraulic	1R-0722	139-1536	4T-3134
Power Train	132-8875		
Power Train	1R-0773		
Power Train	4T-3131		
Air Primary	6I-2499		
Air Secondary	6I-2500		
130G Motor Grader		7GB1224-UP	
Engine Oil	1R-0739		
Fuel Primary	9M-2341		
Fuel Secondary	1R-0750		
Power Train	1R-0719	132-8875	4T-3131
Air Primary	7W-5389		
Air Secondary	2S-1285		
135H Motor Grader		3YK1-UP	
Engine Oil	1R-0739		
Fuel Primary	117-4089		
Fuel Secondary	1R-0751		
Fuel Secondary	1R-0753		
Hydraulic	1R-0722	139-1536	4T-3134
Power Train	1R-0719	132-8875	4T-3131
Power Train	1R-0773		
Air Primary	6I-2499		
Air Secondary	6I-2500		
135H Motor Grader		7MM1-UP	
Engine Oil	1R-0739		
Fuel Primary	117-4089		
Fuel Secondary	1R-0751		
Fuel Secondary	1R-0753		
Hydraulic	1R-0722	139-1536	4T-3134
Power Train	1R-0719	132-8875	4T-3131
Power Train	1R-0773		
Air Primary	6I-2499		
Air Secondary	6I-2500		

a - For quantities, refer to parts book.

Filters - Motor Graders

FILTER TYPE	PART NUMBER	HIGH EFFICIENCY	FIRE RESISTANT
135H Motor Grader		8WN1-UP	
Engine Oil	1R-0739		
Fuel Primary	117-4089		
Fuel Secondary	1R-0751		
Fuel Secondary	1R-0753		
Hydraulic	1R-0722	139-1536	4T-3134
Power Train	132-8875		
Power Train	1R-0773		
Power Train	4T-3131		
Air Primary	6I-2499		
Air Secondary	6I-2500		
135H NA Motor Grader		BDJ1-UP	
Engine Oil	1R-0739		
Fuel Primary	117-4089		
Fuel Secondary	1R-0751		
Fuel Secondary	1R-0753		
Hydraulic	1R-0722	139-1536	4T-3134
Power Train	132-8875		
Power Train	1R-0773		
Power Train	4T-3131		
Air Primary	6I-2499		
Air Secondary	6I-2500		
140B Motor Grader		33C100-UP	
Engine Oil	1R-0739		
Fuel Secondary	1R-0750		
Power Train	8B-5935		
140G Motor Grader		5MD1-UP	
Engine Oil	1R-0739		
Fuel Primary	9M-2341		
Fuel Secondary	1R-0750		
Hydraulic	1R-0719	132-8875	4T-3131
Air Primary	6I-2501		
Air Primary	7W-5317		
Air Secondary	6I-2502		
Air Secondary	9S-9972		
140H Motor Grader		3AS1-UP	
Engine Oil	1R-0739		
Fuel Primary	9M-2341		
Fuel Secondary	1R-0750		
Hydraulic	1R-0774	139-1536	4T-3134
Power Train	132-8875		
Power Train	1R-0773		
Power Train	4T-3131		
Air Primary	6I-0273		
Air Secondary	6I-0274		
140H Motor Grader		5HM1-UP	
Engine Oil	1R-0739		
Fuel Primary	9M-2341		

FILTER TYPE	PART NUMBER	HIGH EFFICIENCY	FIRE RESISTANT
140H Motor Grader (cont.)		5HM1-UP	
Fuel Secondary	1R-0750		
Hydraulic	1R-0774	139-1536	4T-3134
Power Train	132-8875		
Power Train	1R-0773		
Power Train	4T-3131		
Air Primary	6I-0273		
Air Secondary	6I-0274		
140H Motor Grader		8JM1-UP	
Engine Oil	1R-0739		
Fuel Primary	9M-2341		
Fuel Secondary	1R-0750		
Hydraulic	1R-0774	139-1536	4T-3134
Power Train	1R-0719	132-8875	4T-3131
Power Train	1R-0773		
Air Primary	6I-0273		
Air Secondary	6I-0274		
140H Motor Grader		8KM1-UP	
Engine Oil	1R-0739		
Fuel Primary	9M-2341		
Fuel Secondary	1R-0750		
Hydraulic	1R-0774	139-1536	4T-3134
Power Train	1R-0719	132-8875	4T-3131
Power Train	1R-0773		
Air Primary	6I-0273		
Air Secondary	6I-0274		
140H Motor Grader		9TN1-UP	
Engine Oil	1R-0739		
Fuel Primary	9M-2341		
Fuel Secondary	1R-0750		
Hydraulic	1R-0774	139-1536	4T-3134
Power Train	132-8875		
Power Train	1R-0773		
Power Train	4T-3131		
Air Primary	6I-0273		
Air Secondary	6I-0274		
140H Motor Grader		9ZN1-UP	
Engine Oil	1R-0739		
Fuel Primary	9M-2341		
Fuel Secondary	1R-0750		
Hydraulic	1R-0774	139-1536	4T-3134
Power Train	1R-0719	132-8875	4T-3131
Air Primary	6I-0273		
Air Secondary	6I-0274		
140H NA Motor Grader		2ZK1-UP	
Engine Oil	1R-0739		
Fuel Primary	9M-2341		
Fuel Secondary	1R-0750		

a - For quantities, refer to parts book.

Filters - Motor Graders

FILTER TYPE	PART NUMBER	HIGH EFFICIENCY	FIRE RESISTANT
140H NA Motor Grader (cont.)			2ZK1-UP
Hydraulic	1R-0774	139-1536	4T-3134
Power Train	1R-0719	132-8875	4T-3131
Power Train	1R-0773		
Air Primary	6I-0273		
Air Secondary	6I-0274		
143H Motor Grader			1AL1-UP
Engine Oil	1R-0739		
Fuel Primary	9M-2341		
Fuel Secondary	1R-0750		
Hydraulic	1R-0722	139-1536	4T-3134
Power Train	1G-8878	102-2828	156-0214
Power Train	1R-0719	132-8875	4T-3131
Power Train	1R-0773		
Air Primary	6I-0273		
Air Secondary	6I-0274		
160G Motor Grader			4JD1-140
Engine Oil	1R-0739		
Fuel Primary	9M-2341		
Fuel Secondary	1R-0750		
Power Train	1R-0719	132-8875	4T-3131
Air Primary	7W-5317		
Air Secondary	9S-9972		
160G Motor Grader			4JD141-UP
Engine Oil	1R-0739		
Fuel Primary	9M-2341		
Fuel Secondary	1R-0750		
Hydraulic	1R-0719	132-8875	4T-3131
Power Train	1R-0719	132-8875	4T-3131
Air Primary	7W-5317		
Air Secondary	9S-9972		
160H Motor Grader			2FM1-UP
Engine Oil	1R-0739		
Fuel Primary	9M-2341		
Fuel Secondary	1R-0750		
Hydraulic	1R-0722	139-1536	4T-3134
Power Train	132-8875		
Power Train	1R-0773		
Power Train	4T-3131		
Air Primary	6I-0273		
Air Secondary	6I-0274		
160H Motor Grader			2HS1-UP
Engine Oil	1R-0739		
Fuel Primary	9M-2341		
Fuel Secondary	1R-0750		
Hydraulic	1R-0722	139-1536	4T-3134
Power Train	132-8875		
Power Train	1R-0773		

FILTER TYPE	PART NUMBER	HIGH EFFICIENCY	FIRE RESISTANT
160H Motor Grader (cont.)			2HS1-UP
Power Train	4T-3131		
Air Primary	6I-0273		
Air Secondary	6I-0274		
160H Motor Grader			3GM1-UP
Engine Oil	1R-0739		
Fuel Primary	9M-2341		
Fuel Secondary	1R-0750		
Hydraulic	1R-0722	139-1536	4T-3134
Power Train	132-8875		
Power Train	1R-0773		
Power Train	4T-3131		
Air Primary	6I-0273		
Air Secondary	6I-0274		
160H Motor Grader			6WM1-UP
Engine Oil	1R-0739		
Fuel Primary	9M-2341		
Fuel Secondary	1R-0750		
Hydraulic	1R-0722	139-1536	4T-3134
Power Train	1R-0719	132-8875	4T-3131
Power Train	1R-0773		
Air Primary	6I-0273		
Air Secondary	6I-0274		
160H Motor Grader			9EJ1-UP
Engine Oil	1R-0739		
Fuel Primary	9M-2341		
Fuel Secondary	1R-0750		
Hydraulic	1R-0722	139-1536	4T-3134
Power Train	1R-0719	132-8875	4T-3131
Power Train	1R-0773		
Air Primary	6I-0273		
Air Secondary	6I-0274		
160H Motor Grader			9JM1-UP
Engine Oil	1R-0739		
Fuel Primary	9M-2341		
Fuel Secondary	1R-0750		
Hydraulic	1R-0722	139-1536	4T-3134
Power Train	1R-0719	132-8875	4T-3131
Power Train	1R-0773		
Air Primary	6I-0273		
Air Secondary	6I-0274		
163H NA Motor Grader			5AK1-UP
Engine Oil	1R-0739		
Fuel Primary	9M-2341		
Fuel Secondary	1R-0750		
Hydraulic	1R-0722	139-1536	4T-3134
Power Train	1G-8878	102-2828	156-0214
Power Train	1R-0719	132-8875	4T-3131

a - For quantities, refer to parts book.

Filters - Motor Graders, Off-Highway Trucks

FILTER TYPE	PART NUMBER	HIGH EFFICIENCY	FIRE RESISTANT
163H NA Motor Grader (cont.)			5AK1-UP
Power Train	1R-0773		
Air Primary	6I-0273		
Air Secondary	6I-0274		
OFF-HIGHWAY TRUCKS ^a			
769D Off-Highway Truck			5SS1-UP
Engine Oil	1R-0716		
Fuel Primary	129-0373		
Fuel Secondary	1R-0749		
Power Train	1G-8878	102-2828	156-0214
Power Train	4I-3948	126-1813	
Power Train	4T-6788	144-0832	
Hydraulic	130-3212	126-1814	
Air Primary	6I-2505		
Air Secondary	6I-2506		
769D Off-Highway Truck			5TR1-504
Engine Oil	1R-0716		
Fuel Primary	129-0373		
Fuel Secondary	1R-0749		
Hydraulic	1G-8878	102-2828	156-0214
Hydraulic	4T-6788	144-0832	
Power Train	130-3212	126-1814	
Air Primary	6I-2505		
Air Secondary	6I-2506		
769D Off-Highway Truck			5TR505-UP
Engine Oil	1R-0716		
Fuel Primary	129-0373		
Fuel Secondary	1R-0749		
Hydraulic	1R-0719	132-8875	4T-3131
Power Train	1R-0741	132-8876	4T-3132
Air Primary	6I-2505		
Air Secondary	6I-2506		
769D Off-Highway Truck			BBB1-UP
Engine Oil	1R-0716		
Fuel Primary	129-0373		
Fuel Secondary	1R-0749		
Power Train	1G-8878	102-2828	156-0214
Power Train	4I-3948	126-1813	
Power Train	4T-6788	144-0832	
Hydraulic	130-3212	126-1814	
Air Primary	6I-2505		
Air Secondary	6I-2506		
771C Off-Highway Truck			3BJ200-UP
Engine Oil	1R-0716		
Fuel Primary	9M-2341		
Fuel Secondary	1R-0749		
Power Train	1R-0741	132-8876	4T-3132
Hydraulic	1R-0719	132-8875	4T-3131

FILTER TYPE	PART NUMBER	HIGH EFFICIENCY	FIRE RESISTANT
771C Off-Highway Truck (cont.)			3BJ200-UP
Air Primary	6I-2505		
Air Secondary	6I-2506		
771D Off-Highway Truck			6JR1-UP
Engine Oil	1R-0716		
Fuel Primary	129-0373		
Fuel Secondary	1R-0749		
Hydraulic	1R-0719	132-8875	4T-3131
Power Train	1R-0741	132-8876	4T-3132
Air Primary	6I-2505		
Air Secondary	6I-2506		
771D Off-Highway Truck			6YS1-UP
Engine Oil	1R-0716		
Fuel Primary	129-0373		
Fuel Secondary	1R-0749		
Power Train	1G-8878	102-2828	156-0214
Power Train	4I-3948	126-1813	
Power Train	4T-6788	144-0832	
Hydraulic	130-3212	126-1814	
Air Primary	6I-2505		
Air Secondary	6I-2506		
773D Off-Highway Truck			7CS1-UP
Engine Oil	1R-0716		
Fuel Primary	129-0373		
Fuel Secondary	1R-0749		
Power Train	1G-8878	102-2828	156-0214
Power Train	4I-3948	126-1813	
Power Train	4T-6788	144-0832	
Hydraulic	130-3212	126-1814	
Air Primary	6I-2505		
Air Secondary	6I-2506		
773D Off-Highway Truck			7ER1-UP
Engine Oil	1R-0716		
Fuel Primary	129-0373		
Fuel Secondary	1R-0749		
Power Train	1R-0741	132-8876	4T-3132
Air Primary	6I-2505		
Air Secondary	6I-2506		
775B Off-Highway Truck			7XJ200-UP
Engine Oil	1R-0716		
Fuel Primary	9M-2342		
Fuel Secondary	1R-0749		
Power Train	1R-0741	132-8876	4T-3132
Air Primary	6I-2505		
Air Primary	7W-5313		
Air Secondary	1P-8482		
Air Secondary	6I-2506		

a - For quantities, refer to parts book.

Filters - Off-Highway Trucks

FILTER TYPE	PART NUMBER	HIGH EFFICIENCY	FIRE RESISTANT
775D Off-Highway Truck			
		6KR1-123	
Engine Oil	1R-0716		
Fuel Primary	129-0373		
Fuel Secondary	1R-0749		
Power Train	1R-0741	132-8876	4T-3132
Air Primary	6I-2505		
Air Secondary	6I-2506		
777D Off-Highway Truck			
		3PR1-UP	
Engine Oil	2P-4005		
Fuel Primary	9M-2342		
Fuel Secondary	1R-0755		
Power Train	1R-0741	132-8876	4T-3132
Hydraulic	1R-0719	132-8875	4T-3131
Air Primary	106-3969		
Air Secondary	106-3973		
777D Off-Highway Truck			
		AGC1-UP	
Engine Oil	2P-4005		
Fuel Primary	9M-2342		
Fuel Secondary	1R-0755		
Power Train	1R-0741	132-8876	4T-3132
Power Train	4I-3948	126-1813	
Power Train	4T-6788	144-0832	
Hydraulic	1R-0719	132-8875	4T-3131
Air Primary	106-3969		
Air Secondary	106-3973		
777D Off-Highway Truck			
		AGY1-UP	
Engine Oil	2P-4005		
Fuel Primary	9M-2342		
Fuel Secondary	1R-0755		
Power Train	1R-0741	132-8876	4T-3132
Power Train	4I-3948	126-1813	
Power Train	4T-6788	144-0832	
Hydraulic	1R-0719	132-8875	4T-3131
Air Primary	4W-5228		
Air Secondary	1N-4864		
777D HAA Off-Highway Truck			
		2YW1-UP	
Engine Oil	2P-4005		
Fuel Primary	9M-2342		
Fuel Secondary	1R-0755		
Power Train	1R-0741	132-8876	4T-3132
Hydraulic	1R-0719	132-8875	4T-3131
Air Primary	4W-5228		
Air Secondary	1N-4864		
784C Off-Highway Truck			
		2PZ1-UP	
Engine Oil	2P-4005		
Fuel Primary	9M-2342		
Fuel Secondary	1R-0755		
Power Train	1R-0719	132-8875	4T-3131

FILTER TYPE	PART NUMBER	HIGH EFFICIENCY	FIRE RESISTANT
784C Off-Highway Truck (cont.)			
		2PZ1-UP	
Power Train	1R-0741	132-8876	4T-3132
Air Primary	4W-5228		
Air Secondary	1N-4864		
785 Off-Highway Truck			
		8GB1-UP	
Engine Oil	2P-4005		
Fuel Primary	9M-2342		
Fuel Secondary	1R-0755		
Hydraulic	1R-0741	132-8876	4T-3132
Power Train	1R-0719	132-8875	4T-3131
Power Train	1R-0741	132-8876	4T-3132
Air Primary	4W-5228		
Air Secondary	1N-4864		
785B Off-Highway Truck			
		6HK433-UP	
Engine Oil	2P-4005		
Fuel Primary	9M-2342		
Fuel Secondary	1R-0755		
Power Train	1R-0719	132-8875	4T-3131
Power Train	1R-0741	132-8876	4T-3132
Air Primary	4W-5228		
Air Secondary	1N-4864		
785C Off-Highway Truck			
		1HW1-UP	
Engine Oil	2P-4005		
Fuel Primary	9M-2342		
Fuel Secondary	1R-0755		
Power Train	1R-0719	132-8875	4T-3131
Power Train	1R-0741	132-8876	4T-3132
Power Train	1R-0741	132-8876	4T-3132
Air Primary	4W-5228		
Air Secondary	1N-4864		
785C Off-Highway Truck			
		5AZ1-UP	
Engine Oil	2P-4005		
Fuel Primary	9M-2342		
Fuel Secondary	1R-0755		
Power Train	1R-0719	132-8875	4T-3131
Power Train	1R-0741	132-8876	4T-3132
Power Train	1R-0741	132-8876	4T-3132
Air Primary	1W-3637		
Air Secondary	1W-3636		
785C Off-Highway Truck			
		APX1-UP	
Engine Oil	2P-4005		
Fuel Primary	9M-2342		
Fuel Secondary	1R-0755		
Power Train	1R-0719	132-8875	4T-3131
Power Train	1R-0741	132-8876	4T-3132
Air Primary	4W-5228		
Air Secondary	1N-4864		

a - For quantities, refer to parts book.

Filters - Off-Highway Trucks

FILTER TYPE	PART NUMBER	HIGH EFFICIENCY	FIRE RESISTANT
789 Off-Highway Truck			9ZC1-UP
Engine Oil	2P-4005		
Fuel Primary	9M-2342		
Fuel Secondary	1R-0755		
Hydraulic	1R-0722	139-1536	4T-3134
Power Train	1R-0719	132-8875	4T-3131
Power Train	1R-0741	132-8876	4T-3132
Power Train	4T-6915		
Air Primary	1W-3637		
Air Secondary	1W-3636		
789B Off-Highway Truck			7EK1-UP
Engine Oil	2P-4005		
Fuel Primary	9M-2342		
Fuel Secondary	1R-0755		
Hydraulic	1R-0722	139-1536	4T-3134
Power Train	1R-0719	132-8875	4T-3131
Power Train	1R-0741	132-8876	4T-3132
Power Train	4T-6915		
Air Primary	1W-3637		
Air Secondary	1W-3636		
789C Off-Highway Truck			2BW1-UP
Engine Oil	2P-4005		
Fuel Primary	9M-2342		
Fuel Secondary	1R-0755		
Power Train	1R-0719	132-8875	4T-3131
Power Train	1R-0722	139-1536	4T-3134
Power Train	1R-0741	132-8876	4T-3132
Power Train	4T-6915		
Air Primary	1W-3637		
Air Secondary	1W-3636		
793 Off-Highway Truck			3SJ1-UP
Engine Oil	2P-4005		
Fuel Primary	9M-2342		
Fuel Secondary	1R-0755		
Power Train	1R-0719	132-8875	4T-3131
Power Train	1R-0722	139-1536	4T-3134
Power Train	1R-0741	132-8876	4T-3132
Power Train	4T-6915		
Air Primary	9Y-7662		
Air Secondary	9Y-7663		
793B Off-Highway Truck			1HL1-UP
Engine Oil	2P-4005		
Fuel Primary	9M-2342		
Fuel Secondary	1R-0755		
Power Train	108-1153	126-1817	134-3014
Power Train	1R-0719	132-8875	4T-3131
Power Train	1R-0722	139-1536	4T-3134
Power Train	1R-0741	132-8876	4T-3132

FILTER TYPE	PART NUMBER	HIGH EFFICIENCY	FIRE RESISTANT
793B Off-Highway Truck (cont.)			1HL1-UP
Power Train	4T-6915		
Air Primary	9Y-7662		
Air Secondary	9Y-7663		
793C Off-Highway Truck			4AR1-UP
Engine Oil	2P-4005		
Fuel Primary	9M-2342		
Fuel Secondary	1R-0755		
Hydraulic	132-8876		
Power Train	108-1153	126-1817	134-3014
Power Train	1R-0719	132-8875	4T-3131
Power Train	1R-0722	139-1536	4T-3134
Power Train	1R-0741	132-8876	4T-3132
Power Train	4T-6915		
Air Primary	9Y-7662		
Air Secondary	9Y-7663		
793C Off-Highway Truck			4GZ1-UP
Engine Oil	2P-4005		
Fuel Primary	9M-2342		
Fuel Secondary	1R-0755		
Hydraulic	132-8876		
Power Train	108-1153	126-1817	134-3014
Power Train	1R-0719	132-8875	4T-3131
Power Train	1R-0722	139-1536	4T-3134
Power Train	1R-0741	132-8876	4T-3132
Power Train	4T-6915		
Air Primary	9Y-7662		
Air Secondary	9Y-7663		
793C Off-Highway Truck			ATY1-UP
Engine Oil	2P-4005		
Fuel Primary	9M-2342		
Fuel Secondary	1R-0755		
Power Train	108-1153	126-1817	134-3014
Power Train	1R-0719	132-8875	4T-3131
Power Train	1R-0722	139-1536	4T-3134
Power Train	1R-0741	132-8876	4T-3132
Power Train	4T-6915		
Hydraulic	1R-0719	132-8875	4T-3131
Air Primary	9Y-7662		
Air Secondary	9Y-7663		
797 Off-Highway Truck			5YW1-UP
Engine Oil	2P-4005		
Fuel Primary	155-2952		
Fuel Secondary	1R-0755		
Hydraulic	102-2828		
Hydraulic	134-0964	4C-6860	
Hydraulic	159-2967		
Hydraulic	166-6892	167-2009	4T-3133

a - For quantities, refer to parts book.

Filters - Off-Highway Trucks, Scrapers

FILTER TYPE	PART NUMBER	HIGH EFFICIENCY	FIRE RESISTANT
797 Off-Highway Truck (cont.)			5YW1-UP
Hydraulic	1R-0778		
Hydraulic	4T-6788	144-0832	
Power Train	166-6892	167-2009	4T-3133
Power Train	1R-0719	132-8875	4T-3131
Power Train	1R-0778		
Air Primary	1W-3637		
Air Primary	9Y-7662		
Air Secondary	1W-3636		
Air Secondary	9Y-7663		
SCRAPERS ^a			
611 Scraper			6SZ1-UP
Engine Oil	1R-0739		
Fuel Primary	9M-2341		
Fuel Secondary	1R-0750		
Hydraulic	1R-0732	139-1535	4T-3133
Power Train	1R-0719	132-8875	4T-3131
Air Primary	6I-2503		
Air Secondary	6I-2504		
611 Scraper			7WZ1-UP
Engine Oil	1R-0739		
Fuel Primary	9M-2341		
Fuel Secondary	1R-0750		
Hydraulic	1R-0732	139-1535	4T-3133
Power Train	1R-0719	132-8875	4T-3131
Air Primary	6I-2503		
Air Secondary	6I-2504		
613C Series II Scraper			8LJ1-UP
Engine Oil	1R-0739		
Fuel Secondary	1R-0751		
Hydraulic	1R-0741	132-8876	4T-3132
Power Train	1R-0719	132-8875	4T-3131
Air Primary	6I-2503		
Air Primary	7W-5316		
Air Secondary	2S-1287		
Air Secondary	6I-2504		
613C Series II Scraper			93X2780-UP
Engine Oil	1R-0739		
Fuel Primary	117-4089		
Fuel Primary	8N-9803		
Fuel Secondary	1R-0751		
Air Primary	6I-2503		
Air Primary	7W-5316		
Air Secondary	2S-1287		
Air Secondary	6I-2504		
615 Scraper			47Z1-UP
Hydraulic	1R-0732	139-1535	4T-3133
Power Train	7W-8910		

FILTER TYPE	PART NUMBER	HIGH EFFICIENCY	FIRE RESISTANT
615 Scraper (cont.)			47Z1-UP
Power Train	9M-2341		
621B Scraper			2DB1-UP
Engine Oil	1R-0716		
Fuel Primary	9M-2341		
Fuel Secondary	1R-0749		
Hydraulic	1R-0732	139-1535	4T-3133
Power Train	1R-0719	132-8875	4T-3131
Air Primary	7W-5495		
Air Secondary	1P-7360		
621B Scraper			6XB1-UP
Engine Oil	1R-0716		
Fuel Primary	9M-2341		
Fuel Secondary	1R-0749		
Hydraulic	1R-0732	139-1535	4T-3133
Power Train	1R-0719	132-8875	4T-3131
Air Primary	7W-5495		
Air Secondary	1P-7360		
621B Scraper			7KC1-UP
Engine Oil	1R-0716		
Fuel Primary	9M-2341		
Fuel Secondary	1R-0749		
Hydraulic	1R-0732	139-1535	4T-3133
Power Train	1R-0719	132-8875	4T-3131
Air Primary	7W-5495		
Air Secondary	1P-7360		
621B Scraper			8HC1-UP
Engine Oil	1R-0716		
Fuel Primary	9M-2341		
Fuel Secondary	1R-0749		
Hydraulic	1R-0732	139-1535	4T-3133
Power Train	1R-0719	132-8875	4T-3131
Air Primary	7W-5495		
Air Secondary	1P-7360		
621B Scraper			9AC1-UP
Engine Oil	1R-0716		
Fuel Primary	9M-2341		
Fuel Secondary	1R-0749		
Hydraulic	1R-0732	139-1535	4T-3133
Power Train	1R-0719	132-8875	4T-3131
Air Primary	7W-5495		
Air Secondary	1P-7360		
627E PS Scraper			6EB1-UP
Engine Oil	1R-0716		
Engine Oil	1R-0739		
Engine Oil	1R-0716		
Fuel Primary	9M-2341		
Fuel Secondary	1R-0749		

a - For quantities, refer to parts book.

Filters - Scrapers

FILTER TYPE	PART NUMBER	HIGH EFFICIENCY	FIRE RESISTANT
627E PS Scraper (cont.)			6EB1-UP
Fuel Secondary	1R-0750		
Hydraulic	1R-0732	139-1535	4T-3133
Power Train	1R-0719	132-8875	4T-3131
Power Train	1R-0732	139-1535	4T-3133
Air Primary	7W-5495		
Air Secondary	1P-7360		
627E PS Scraper			6FB1-UP
Engine Oil	1R-0716		
Engine Oil	1R-0739		
Engine Oil	1R-0716		
Fuel Primary	9M-2341		
Fuel Secondary	1R-0750		
Power Train	1R-0719	132-8875	4T-3131
Air Primary	7W-5316		
Air Secondary	8N-6883		
627E PS Scraper			6GB1-UP
Engine Oil	1R-0716		
Engine Oil	1R-0739		
Engine Oil	1R-0716		
Fuel Primary	9M-2341		
Fuel Secondary	1R-0750		
Hydraulic	1R-0732	139-1535	4T-3133
Power Train	1R-0719	132-8875	4T-3131
Power Train	1R-0732	139-1535	4T-3133
Air Primary	7W-5495		
Air Secondary	1P-7360		
627E PS Scraper			6HB1-UP
Engine Oil	1R-0716		
Engine Oil	1R-0739		
Engine Oil	1R-0716		
Fuel Primary	9M-2341		
Fuel Secondary	1R-0750		
Power Train	1R-0719	132-8875	4T-3131
Air Primary	7W-5316		
Air Secondary	8N-6883		
627G Scraper			AYK1-UP
Engine Oil	1R-0739		
Fuel Primary	9M-2341		
Fuel Secondary	1R-0750		
Hydraulic	9T-0973	126-1817	134-3014
Power Train	1R-0719	132-8875	4T-3131
Air Primary	6I-2507		
Air Secondary	6I-2508		
637D Scraper			4JB1-UP
Engine Oil	1R-0739		
Fuel Primary	9M-2341		
Fuel Secondary	1R-0750		

FILTER TYPE	PART NUMBER	HIGH EFFICIENCY	FIRE RESISTANT
637D Scraper (cont.)			4JB1-UP
Power Train	1R-0719	132-8875	4T-3131
Air Primary	7W-5313		
Air Primary	7W-5316		
Air Secondary	1P-8482		
Air Secondary	2S-1287		
637E Scraper			1HB1-690
Engine Oil	1R-0739		
Fuel Primary	9M-2341		
Fuel Secondary	1R-0750		
Power Train	1R-0719	132-8875	4T-3131
Air Primary	6I-2507		
Air Primary	7W-5313		
Air Primary	7W-5316		
Air Secondary	1P-8482		
Air Secondary	6I-2508		
Air Secondary	6N-6444		
Air Secondary	8N-6883		
637E Scraper			1LB1-UP
Engine Oil	1R-0739		
Fuel Primary	9M-2341		
Fuel Secondary	1R-0750		
Power Train	1R-0719	132-8875	4T-3131
Air Primary	7W-5313		
Air Primary	7W-5316		
Air Secondary	1P-8482		
Air Secondary	8N-6883		
637E Scraper			7CB1-179
Engine Oil	1R-0739		
Fuel Primary	9M-2341		
Fuel Secondary	1R-0750		
Power Train	1R-0719	132-8875	4T-3131
Air Primary	6I-2507		
Air Primary	7W-5313		
Air Primary	7W-5316		
Air Secondary	1P-8482		
Air Secondary	6I-2508		
Air Secondary	6N-6444		
Air Secondary	8N-6883		
637G Scraper			AWE1-UP
Engine Oil	1R-0739		
Fuel Primary	9M-2341		
Fuel Secondary	1R-0750		
Power Train	1R-0719	132-8875	4T-3131
Air Primary	6I-2507		
Air Secondary	6I-2508		
637G Scraper			AYN1-UP
Engine Oil	1R-0739		

a - For quantities, refer to parts book.

Filters - Scrapers, Skid Steer Loaders

FILTER TYPE	PART NUMBER	HIGH EFFICIENCY	FIRE RESISTANT
637G Scraper (cont.)		AYN1-UP	
Fuel Primary	9M-2341		
Fuel Secondary	1R-0750		
Power Train	1R-0719	132-8875	4T-3131
Air Primary	6I-2507		
Air Secondary	6I-2508		
657E Scraper		6PR1-UP	
Engine Oil	1R-0716		
Fuel Secondary	1R-0749		
Power Train	1R-0719	132-8875	4T-3131
Air Primary	6I-2505		
Air Secondary	6I-2506		
SKID STEER LOADERS ^a			
216 Skid Steer Loader		4NZ1-UP	
Engine Oil	7W-2327		
Fuel Primary	131-1812		
Fuel Primary	163-4465		
Fuel Secondary	159-6102		
Power Train	1G-8878	102-2828	156-0214
Air Primary	134-8726		
Air Secondary	140-2334		
216 Skid Steer Loader		5FZ1-UP	
Engine Oil	7W-2327		
Fuel Primary	163-4465		
Fuel Secondary	159-6102		
Power Train	1G-8878	102-2828	156-0214
Air Primary	134-8726		
Air Secondary	140-2334		
216 Skid Steer Loader		6BZ1-699	
Engine Oil	7W-2327		
Fuel Primary	131-1812		
Fuel Secondary	159-6102		
Power Train	1G-8878	102-2828	156-0214
Air Primary	134-8726		
Air Secondary	140-2334		
226 Skid Steer Loader		4NZ1-UP	
Engine Oil	7W-2327		
Fuel Primary	131-1812		
Fuel Primary	163-4465		
Fuel Secondary	159-6102		
Power Train	1G-8878	102-2828	156-0214
Air Primary	134-8726		
Air Secondary	140-2334		
226 Skid Steer Loader		5FZ1-6699	
Engine Oil	7W-2327		
Fuel Primary	163-4465		
Fuel Secondary	159-6102		
Power Train	1G-8878	102-2828	156-0214

FILTER TYPE	PART NUMBER	HIGH EFFICIENCY	FIRE RESISTANT
226 Skid Steer Loader (cont.)		5FZ1-6699	
Air Primary	134-8726		
Air Secondary	140-2334		
226 Skid Steer Loader		5FZ6700-UP	
Engine Oil	7W-2327		
Fuel Primary	131-1812		
Fuel Secondary	159-6102		
Power Train	1G-8878	102-2828	156-0214
Air Primary	134-8726		
Air Secondary	140-2334		
226 Skid Steer Loader		6BZ1-699	
Engine Oil	7W-2327		
Fuel Primary	131-1812		
Fuel Secondary	159-6102		
Power Train	1G-8878	102-2828	156-0214
Air Primary	134-8726		
Air Secondary	140-2334		
228 Skid Steer Loader		4NZ1-UP	
Engine Oil	7W-2327		
Fuel Primary	131-1812		
Fuel Primary	163-4465		
Fuel Secondary	159-6102		
Power Train	1G-8878	102-2828	156-0214
Air Primary	134-8726		
Air Secondary	140-2334		
228 Skid Steer Loader		5FZ1-6699	
Engine Oil	7W-2327		
Fuel Primary	163-4465		
Fuel Secondary	159-6102		
Power Train	1G-8878	102-2828	156-0214
Air Primary	134-8726		
Air Secondary	140-2334		
228 Skid Steer Loader		5FZ6700-UP	
Engine Oil	7W-2327		
Fuel Primary	131-1812		
Fuel Secondary	159-6102		
Power Train	1G-8878	102-2828	156-0214
Air Primary	134-8726		
Air Secondary	140-2334		
228 Skid Steer Loader		6BZ1-UP	
Engine Oil	7W-2327		
Fuel Primary	131-1812		
Fuel Secondary	159-6102		
Power Train	1G-8878	102-2828	156-0214
Air Primary	134-8726		
Air Secondary	140-2334		
236 Skid Steer Loader		4YZ1-3999	
Engine Oil	7W-2327		

a - For quantities, refer to parts book.

Filters - Skid Steer Loaders

FILTER TYPE	PART NUMBER	HIGH EFFICIENCY	FIRE RESISTANT
236 Skid Steer Loader (cont.)		4YZ1-3999	
Fuel Primary	131-1812		
Fuel Primary	163-4465		
Fuel Secondary	159-6102		
Power Train	1G-8878	102-2828	156-0214
Air Primary	110-6326		
Air Primary	134-8726		
Air Secondary	110-6331		
Air Secondary	140-2334		
236 Skid Steer Loader		4YZ4000-UP	
Engine Oil	7W-2327		
Fuel Primary	131-1812		
Fuel Secondary	159-6102		
Power Train	1G-8878	102-2828	156-0214
Air Primary	110-6326		
Air Primary	134-8726		
Air Secondary	110-6331		
Air Secondary	140-2334		
236 Skid Steer Loader		5SZ1-3999	
Engine Oil	7W-2327		
Fuel Primary	131-1812		
Fuel Primary	163-4465		
Fuel Secondary	159-6102		
Power Train	1G-8878	102-2828	156-0214
Air Primary	110-6326		
Air Secondary	110-6331		
236 Skid Steer Loader		5SZ4000-UP	
Engine Oil	7W-2327		
Fuel Primary	131-1812		
Fuel Secondary	159-6102		
Power Train	1G-8878	102-2828	156-0214
Air Primary	110-6326		
Air Primary	134-8726		
Air Secondary	110-6331		
Air Secondary	140-2334		
236 Skid Steer Loader		6LZ1-999	
Engine Oil	7W-2327		
Fuel Primary	163-4465		
Fuel Secondary	159-6102		
Power Train	1G-8878	102-2828	156-0214
Air Primary	134-8726		
Air Secondary	140-2334		
236 Skid Steer Loader		6LZ1000-UP	
Engine Oil	7W-2327		
Fuel Primary	131-1812		
Fuel Secondary	159-6102		
Power Train	1G-8878	102-2828	156-0214
Air Primary	110-6326		

FILTER TYPE	PART NUMBER	HIGH EFFICIENCY	FIRE RESISTANT
236 Skid Steer Loader (cont.)		6LZ1000-UP	
Air Secondary	110-6331		
236 Skid Steer Loader		CED1-UP	
Engine Oil	7W-2327		
Fuel Primary	131-1812		
Fuel Secondary	159-6102		
Power Train	1G-8878	102-2828	156-0214
Air Primary	110-6326		
Air Secondary	110-6331		
236 Skid Steer Loader		FDG1-UP	
Engine Oil	7W-2327		
Fuel Primary	131-1812		
Fuel Secondary	159-6102		
Power Train	1G-8878	102-2828	156-0214
Air Primary	134-8726		
Air Secondary	140-2334		
246 Skid Steer Loader		4YZ1-3999	
Engine Oil	7W-2327		
Fuel Primary	131-1812		
Fuel Primary	163-4465		
Fuel Secondary	159-6102		
Power Train	1G-8878	102-2828	156-0214
Air Primary	134-8726		
Air Secondary	140-2334		
246 Skid Steer Loader		4YZ4000-UP	
Engine Oil	7W-2327		
Fuel Primary	131-1812		
Fuel Secondary	159-6102		
Power Train	1G-8878	102-2828	156-0214
Air Primary	110-6326		
Air Secondary	110-6331		
246 Skid Steer Loader		5SZ1-3999	
Engine Oil	7W-2327		
Fuel Primary	131-1812		
Fuel Primary	163-4465		
Fuel Secondary	159-6102		
Power Train	1G-8878	102-2828	156-0214
Air Primary	110-6326		
Air Secondary	110-6331		
246 Skid Steer Loader		5SZ4000-UP	
Engine Oil	7W-2327		
Fuel Primary	131-1812		
Fuel Secondary	159-6102		
Power Train	1G-8878	102-2828	156-0214
Air Primary	134-8726		
Air Secondary	140-2334		
246 Skid Steer Loader		6LZ1-999	
Engine Oil	7W-2327		

a - For quantities, refer to parts book.

Filters - Skid Steer Loaders

FILTER TYPE	PART NUMBER	HIGH EFFICIENCY	FIRE RESISTANT
246 Skid Steer Loader (cont.)		6LZ1-999	
Fuel Primary	163-4465		
Fuel Secondary	159-6102		
Power Train	1G-8878	102-2828	156-0214
Air Primary	134-8726		
Air Secondary	140-2334		
246 Skid Steer Loader		6LZ1000-UP	
Engine Oil	7W-2327		
Fuel Primary	131-1812		
Fuel Secondary	159-6102		
Power Train	1G-8878	102-2828	156-0214
Air Primary	110-6326		
Air Secondary	110-6331		
246 Skid Steer Loader		CED1-UP	
Engine Oil	7W-2327		
Fuel Primary	131-1812		
Fuel Secondary	159-6102		
Power Train	1G-8878	102-2828	156-0214
Air Primary	110-6326		
Air Secondary	110-6331		
246 Skid Steer Loader		FDG1-UP	
Engine Oil	7W-2327		
Fuel Primary	131-1812		
Fuel Secondary	159-6102		
Power Train	1G-8878	102-2828	156-0214
Air Primary	134-8726		
Air Secondary	140-2334		
248 Skid Steer Loader		4YZ1-3999	
Engine Oil	7W-2327		
Fuel Primary	131-1812		
Fuel Primary	163-4465		
Fuel Secondary	159-6102		
Power Train	1G-8878	102-2828	156-0214
Air Primary	110-6326		
Air Primary	134-8726		
Air Secondary	110-6331		
Air Secondary	140-2334		
248 Skid Steer Loader		5SZ1-3999	
Engine Oil	7W-2327		
Fuel Primary	131-1812		
Fuel Primary	163-4465		
Fuel Secondary	159-6102		
Power Train	1G-8878	102-2828	156-0214
Air Primary	110-6326		
Air Secondary	110-6331		
248 Skid Steer Loader		6LZ1-999	
Engine Oil	7W-2327		
Fuel Primary	163-4465		

FILTER TYPE	PART NUMBER	HIGH EFFICIENCY	FIRE RESISTANT
248 Skid Steer Loader (cont.)		6LZ1-999	
Fuel Secondary	159-6102		
Power Train	1G-8878	102-2828	156-0214
Air Primary	110-6326		
Air Primary	134-8726		
Air Secondary	110-6331		
Air Secondary	140-2334		
248 Skid Steer Loader		6LZ1000-UP	
Engine Oil	7W-2327		
Fuel Primary	131-1812		
Fuel Secondary	159-6102		
Power Train	1G-8878	102-2828	156-0214
Air Primary	110-6326		
Air Secondary	110-6331		
252 Skid Steer Loader		4YZ4000-UP	
Engine Oil	7W-2327		
Fuel Primary	131-1812		
Fuel Secondary	159-6102		
Power Train	1G-8878	102-2828	156-0214
Air Primary	110-6326		
Air Primary	134-8726		
Air Secondary	110-6331		
Air Secondary	140-2334		
252 Skid Steer Loader		5SZ4000-UP	
Engine Oil	7W-2327		
Fuel Primary	131-1812		
Fuel Secondary	159-6102		
Power Train	1G-8878	102-2828	156-0214
Air Primary	110-6326		
Air Primary	134-8726		
Air Secondary	110-6331		
Air Secondary	140-2334		
252 Skid Steer Loader		CED1-UP	
Engine Oil	7W-2327		
Fuel Primary	131-1812		
Fuel Secondary	159-6102		
Power Train	1G-8878	102-2828	156-0214
Air Primary	110-6326		
Air Secondary	110-6331		
252 Skid Steer Loader		FDG1-UP	
Engine Oil	7W-2327		
Fuel Primary	131-1812		
Fuel Secondary	159-6102		
Power Train	1G-8878	102-2828	156-0214
Air Primary	134-8726		
Air Secondary	140-2334		
262 Skid Steer Loader		4YZ4000-UP	
Engine Oil	7W-2327		

a - For quantities, refer to parts book.

Filters - Skid Steer Loaders, Track Loaders

FILTER TYPE	PART NUMBER	HIGH EFFICIENCY	FIRE RESISTANT
262 Skid Steer Loader (cont.)		4YZ4000-UP	
Fuel Primary	131-1812		
Fuel Secondary	159-6102		
Power Train	1G-8878	102-2828	156-0214
Air Primary	110-6326		
Air Primary	134-8726		
Air Secondary	110-6331		
Air Secondary	140-2334		
262 Skid Steer Loader		5SZ4000-UP	
Engine Oil	7W-2327		
Fuel Primary	131-1812		
Fuel Secondary	159-6102		
Power Train	1G-8878	102-2828	156-0214
Air Primary	110-6326		
Air Primary	134-8726		
Air Secondary	110-6331		
Air Secondary	140-2334		
262 Skid Steer Loader		CED1-UP	
Engine Oil	7W-2327		
Fuel Primary	131-1812		
Fuel Secondary	159-6102		
Power Train	1G-8878	102-2828	156-0214
Air Primary	110-6326		
Air Secondary	110-6331		
262 Skid Steer Loader		FDG1-UP	
Engine Oil	7W-2327		
Fuel Primary	131-1812		
Fuel Secondary	159-6102		
Power Train	1G-8878	102-2828	156-0214
Air Primary	134-8726		
Air Secondary	140-2334		
TRACK LOADERS ^a			
931B Track Loader		4SC1-UP	
Engine Oil	1R-0713		
Fuel Secondary	1R-0710		
Hydraulic	1R-0719	132-8875	4T-3131
Power Train	1R-0746	126-1810	
Air Primary	4N-0326		
Air Secondary	4N-0313		
931B Track Loader		6EC1-UP	
Engine Oil	1R-0713		
Fuel Secondary	1R-0710		
Hydraulic	1R-0719	132-8875	4T-3131
Power Train	1R-0746	126-1810	
Air Primary	4N-0326		
Air Secondary	4N-0313		
931B Track Loader		25Y1-UP	
Engine Oil	1R-0713		

FILTER TYPE	PART NUMBER	HIGH EFFICIENCY	FIRE RESISTANT
931B Track Loader (cont.)		25Y1-UP	
Fuel Secondary	1R-0710		
Hydraulic	1R-0719	132-8875	4T-3131
Air Primary	4N-0326		
Air Secondary	4N-0313		
931B LGP Track Loader		4SC1-UP	
Engine Oil	1R-0713		
Fuel Secondary	1R-0710		
Hydraulic	1R-0719	132-8875	4T-3131
Power Train	1R-0746	126-1810	
Air Primary	4N-0326		
Air Secondary	4N-0313		
931B LGP Track Loader		6EC1-UP	
Engine Oil	1R-0713		
Fuel Secondary	1R-0710		
Hydraulic	1R-0719	132-8875	4T-3131
Power Train	1R-0746	126-1810	
Air Primary	4N-0326		
Air Secondary	4N-0313		
931C Track Loader		2AK1-UP	
Engine Oil	1R-0713		
Fuel Secondary	1R-0750		
Hydraulic	1R-0719	132-8875	4T-3131
Power Train	1R-0746	126-1810	
Air Primary	4N-0326		
Air Secondary	4N-0313		
931C Track Loader		6AJ1-UP	
Engine Oil	1R-0713		
Fuel Secondary	1R-0750		
Hydraulic	1R-0719	132-8875	4T-3131
Power Train	1R-0746	126-1810	
Air Primary	4N-0326		
Air Secondary	4N-0313		
931C Track Loader		7HF1-UP	
Engine Oil	1R-0713		
Fuel Secondary	1R-0750		
Hydraulic	1R-0719	132-8875	4T-3131
Air Primary	4N-0326		
Air Secondary	4N-0313		
931C Track Loader		8AF1-UP	
Engine Oil	1R-0713		
Fuel Secondary	1R-0750		
Hydraulic	1R-0719	132-8875	4T-3131
Air Primary	4N-0326		
Air Secondary	4N-0313		
931C Series II Track Loader		9AG1-UP	
Engine Oil	1R-0713		
Fuel Secondary	1R-0750		

a - For quantities, refer to parts book.

Filters - Track Loaders

FILTER TYPE	PART NUMBER	HIGH EFFICIENCY	FIRE RESISTANT
931C Series II Track Loader (cont.)			9AG1-UP
Hydraulic	1R-0719	132-8875	4T-3131
Air Primary	4N-0326		
Air Secondary	4N-0313		
931C LGP Track Loader			5LG1-UP
Engine Oil	1R-0713		
Fuel Secondary	1R-0750		
Hydraulic	1R-0719	132-8875	4T-3131
Power Train	1R-0746	126-1810	
Air Primary	4N-0326		
Air Secondary	4N-0313		
931C LGP Track Loader			7HF1-UP
Engine Oil	1R-0713		
Fuel Secondary	1R-0750		
Hydraulic	1R-0719	132-8875	4T-3131
Air Primary	4N-0326		
Air Secondary	4N-0313		
931C LGP Track Loader			8AF1-UP
Engine Oil	1R-0713		
Fuel Secondary	1R-0750		
Hydraulic	1R-0719	132-8875	4T-3131
Air Primary	4N-0326		
Air Secondary	4N-0313		
931C LGP Series II Track Loader			2AK1-UP
Engine Oil	1R-0713		
Fuel Secondary	1R-0750		
Hydraulic	1R-0719	132-8875	4T-3131
Power Train	1R-0746	126-1810	
Air Primary	4N-0326		
Air Secondary	4N-0313		
931C LGP Series II Track Loader			6AJ1-UP
Engine Oil	1R-0713		
Fuel Secondary	1R-0750		
Hydraulic	1R-0719	132-8875	4T-3131
Power Train	1R-0746	126-1810	
Air Primary	4N-0326		
Air Secondary	4N-0313		
933 Track Loader			8FL1-UP
Engine Oil	1R-0734		
Fuel Primary	118-5768		
Fuel Secondary	5I-7951		
Hydraulic	1R-0719	132-8875	4T-3131
Power Train	1R-0746	126-1810	
Air Primary	4N-0326		
Air Secondary	4N-0313		
933 Track Loader			9EL1-UP
Engine Oil	1R-0734		
Fuel Primary	118-5768		

FILTER TYPE	PART NUMBER	HIGH EFFICIENCY	FIRE RESISTANT
933 Track Loader (cont.)			9EL1-UP
Fuel Secondary	5I-7951		
Hydraulic	1R-0719	132-8875	4T-3131
Power Train	1R-0746	126-1810	
Air Primary	4N-0326		
Air Secondary	4N-0313		
933 LGP Track Loader			8FL1-UP
Engine Oil	1R-0734		
Fuel Primary	118-5768		
Fuel Secondary	5I-7951		
Hydraulic	1R-0719	132-8875	4T-3131
Power Train	1R-0746	126-1810	
Air Primary	4N-0326		
Air Secondary	4N-0313		
933 LGP Track Loader			9EL1-UP
Engine Oil	1R-0734		
Fuel Primary	118-5768		
Fuel Secondary	5I-7951		
Hydraulic	1R-0719	132-8875	4T-3131
Power Train	1R-0746	126-1810	
Air Primary	4N-0326		
Air Secondary	4N-0313		
933C Track Loader			4MS1-UP
Engine Oil	1R-0734		
Fuel Primary	118-5768		
Fuel Secondary	5I-7951		
Power Train	1G-8878	102-2828	156-0214
Air Primary	4N-0326		
Air Secondary	4N-0313		
933C Track Loader			5JS1-UP
Engine Oil	1R-0734		
Fuel Primary	118-5768		
Fuel Secondary	5I-7951		
Power Train	1G-8878	102-2828	156-0214
Air Primary	4N-0326		
Air Secondary	4N-0313		
933C LGP Track Loader			4MS1-UP
Engine Oil	1R-0734		
Fuel Primary	118-5768		
Fuel Secondary	5I-7951		
Power Train	1G-8878	102-2828	156-0214
Air Primary	4N-0326		
Air Secondary	4N-0313		
933C LGP Track Loader			5JS1-UP
Engine Oil	1R-0734		
Fuel Primary	118-5768		
Fuel Secondary	5I-7951		
Power Train	1G-8878	102-2828	156-0214

a - For quantities, refer to parts book.

Filters - Track Loaders

FILTER TYPE	PART NUMBER	HIGH EFFICIENCY	FIRE RESISTANT
933C LGP Track Loader (cont.)			5JS1-UP
Air Primary	4N-0326		
Air Secondary	4N-0313		
935B Track Loader			3DF1-UP
Engine Oil	1R-0713		
Fuel Secondary	1R-0710		
Hydraulic	1R-0719	132-8875	4T-3131
Power Train	1R-0746	126-1810	
Air Primary	4N-0326		
Air Secondary	4N-0313		
935C Track Loader			8CF1-UP
Engine Oil	1R-0713		
Fuel Secondary	1R-0750		
Hydraulic	1R-0719	132-8875	4T-3131
Power Train	1R-0746	126-1810	
Air Primary	4N-0326		
Air Secondary	4N-0313		
935C Series II Track Loader			5DJ1-UP
Engine Oil	1R-0713		
Fuel Secondary	1R-0750		
Hydraulic	1R-0719	132-8875	4T-3131
Power Train	1R-0746	126-1810	
Air Primary	4N-0326		
Air Secondary	4N-0313		
939 Track Loader			9GL1-UP
Engine Oil	1R-0734		
Fuel Secondary	5I-7951		
Hydraulic	1R-0719	132-8875	4T-3131
Power Train	1R-0746	126-1810	
Air Primary	4N-0326		
Air Secondary	4N-0313		
939C Track Loader			6DS1-UP
Engine Oil	1R-0734		
Fuel Secondary	5I-7951		
Power Train	1G-8878	102-2828	156-0214
Air Primary	4N-0326		
Air Secondary	4N-0313		
943 Track Loader			03Y1-1385
Engine Oil	1R-0714		
Fuel Primary	9M-2341		
Fuel Secondary	1R-0750		
Hydraulic	1R-0722	139-1536	4T-3134
Power Train	132-8875		
Air Primary	7W-5389		
Air Secondary	8N-4901		
943 Track Loader			03Y1386-UP
Engine Oil	1R-0714		
Fuel Primary	9M-2341		

FILTER TYPE	PART NUMBER	HIGH EFFICIENCY	FIRE RESISTANT
943 Track Loader (cont.)			03Y1386-UP
Fuel Secondary	1R-0750		
Hydraulic	1R-0722	139-1536	4T-3134
Power Train	132-8875		
Power Train	132-8876		
Air Primary	7W-5389		
Air Secondary	8N-4901		
943 LGP Track Loader			19Z1-252
Engine Oil	1R-0714		
Fuel Primary	9M-2341		
Fuel Secondary	1R-0750		
Hydraulic	1R-0722	139-1536	4T-3134
Power Train	1R-0741	132-8876	4T-3132
Air Primary	7W-5389		
Air Secondary	8N-4901		
943 LGP Track Loader			19Z253-UP
Engine Oil	1R-0714		
Fuel Primary	9M-2341		
Fuel Secondary	1R-0750		
Hydraulic	1R-0722	139-1536	4T-3134
Power Train	132-8875		
Power Train	132-8876		
Air Primary	7W-5389		
Air Secondary	8N-4901		
953 Track Loader			44Z1-UP
Engine Oil	1R-0714		
Fuel Primary	9M-2341		
Fuel Secondary	1R-0750		
Hydraulic	1R-0722	139-1536	4T-3134
Power Train	1R-0741	132-8876	4T-3132
Air Primary	7W-5317		
Air Secondary	9S-9972		
953 Track Loader			76Y1-UP
Engine Oil	1R-0714		
Fuel Primary	9M-2341		
Fuel Secondary	1R-0750		
Hydraulic	1R-0722	139-1536	4T-3134
Power Train	1R-0741	132-8876	4T-3132
Air Primary	7W-5317		
Air Secondary	9S-9972		
953 Track Loader			77Y1-1092
Engine Oil	1R-0714		
Fuel Primary	9M-2341		
Fuel Secondary	1R-0750		
Hydraulic	1R-0722	139-1536	4T-3134
Power Train	1R-0741	132-8876	4T-3132
Air Primary	7W-5317		
Air Secondary	9S-9972		

a - For quantities, refer to parts book.

Filters - Track Loaders

FILTER TYPE	PART NUMBER	HIGH EFFICIENCY	FIRE RESISTANT
953 Track Loader		77Y1093-UP	
Engine Oil	1R-0714		
Fuel Primary	9M-2341		
Fuel Secondary	1R-0750		
Hydraulic	1R-0722	139-1536	4T-3134
Power Train	132-8876		
Air Primary	7W-5317		
Air Secondary	9S-9972		
953 Track Loader		78Y1-UP	
Engine Oil	1R-0714		
Fuel Primary	9M-2341		
Fuel Secondary	1R-0750		
Hydraulic	1R-0722	139-1536	4T-3134
Power Train	1R-0741	132-8876	4T-3132
Air Primary	7W-5317		
Air Secondary	9S-9972		
953 LGP Track Loader		05Z1-UP	
Engine Oil	1R-0714		
Fuel Primary	9M-2341		
Fuel Secondary	1R-0750		
Hydraulic	1R-0722	139-1536	4T-3134
Power Train	1R-0741	132-8876	4T-3132
Air Primary	7W-5317		
Air Secondary	9S-9972		
953 LGP Track Loader		20Z1-266	
Engine Oil	1R-0714		
Fuel Primary	9M-2341		
Fuel Secondary	1R-0750		
Hydraulic	1R-0722	139-1536	4T-3134
Power Train	1R-0741	132-8876	4T-3132
Air Primary	7W-5317		
Air Secondary	9S-9972		
953 LGP Track Loader		20Z267-UP	
Engine Oil	1R-0714		
Fuel Primary	9M-2341		
Fuel Secondary	1R-0750		
Hydraulic	1R-0722	139-1536	4T-3134
Power Train	132-8876		
Air Primary	7W-5317		
Air Secondary	9S-9972		
953B Track Loader		5MK1-UP	
Engine Oil	1R-0739		
Fuel Primary	9M-2341		
Fuel Secondary	1R-0751		
Hydraulic	1R-0722	139-1536	4T-3134
Power Train	132-8876		
Air Primary	6I-2499		
Air Secondary	6I-2500		

FILTER TYPE	PART NUMBER	HIGH EFFICIENCY	FIRE RESISTANT
953C Track Loader		22N1-942	
Engine Oil	1R-0739		
Fuel Primary	117-4089		
Fuel Secondary	1R-0751		
Hydraulic	1R-0722	139-1536	4T-3134
Power Train	108-1153	126-1817	134-3014
Power Train	4T-6788	144-0832	
Air Primary	6I-2499		
Air Secondary	6I-2500		
953C Track Loader		22N943-UP	
Engine Oil	1R-0739		
Fuel Primary	117-4089		
Fuel Secondary	1R-0751		
Fuel Secondary	1R-0753		
Hydraulic	1R-0722	139-1536	4T-3134
Power Train	108-1153	126-1817	134-3014
Power Train	4T-6788	144-0832	
Air Primary	6I-0273		
Air Secondary	6I-0274		
963 Track Loader		06Z1-UP	
Engine Oil	1R-0739		
Fuel Primary	9M-2341		
Fuel Secondary	1R-0750		
Hydraulic	1R-0722	139-1536	4T-3134
Power Train	1R-0741	132-8876	4T-3132
Air Primary	7W-5495		
Air Secondary	1P-7360		
963 Track Loader		18Z1-UP	
Engine Oil	1R-0739		
Fuel Primary	9M-2341		
Fuel Secondary	1R-0750		
Hydraulic	1R-0722	139-1536	4T-3134
Power Train	132-8876		
Air Primary	7W-5495		
Air Secondary	1P-7360		
963 Track Loader		29S1-UP	
Engine Oil	1R-0739		
Fuel Primary	9M-2341		
Fuel Secondary	1R-0750		
Hydraulic	1R-0722	139-1536	4T-3134
Power Train	1R-0741	132-8876	4T-3132
Air Primary	7W-5495		
Air Secondary	1P-7360		
963 Track Loader		48Z1-UP	
Engine Oil	1R-0739		
Fuel Primary	9M-2341		
Fuel Secondary	1R-0750		
Hydraulic	1R-0722	139-1536	4T-3134

a - For quantities, refer to parts book.

Filters - Track Loaders

FILTER TYPE	PART NUMBER	HIGH EFFICIENCY	FIRE RESISTANT
963 Track Loader (cont.)			48Z1-UP
Power Train	1R-0741	132-8876	4T-3132
Air Primary	7W-5495		
Air Secondary	1P-7360		
963 LGP Track Loader			11Z1-UP
Engine Oil	1R-0739		
Fuel Primary	9M-2341		
Fuel Secondary	1R-0750		
Hydraulic	1R-0722	139-1536	4T-3134
Power Train	1R-0741	132-8876	4T-3132
Air Primary	7W-5495		
Air Secondary	1P-7360		
963 LGP Track Loader			21Z1-UP
Engine Oil	1R-0739		
Fuel Primary	9M-2341		
Fuel Secondary	1R-0750		
Hydraulic	1R-0722	139-1536	4T-3134
Hydraulic	4T-3130		
Power Train	132-8876		
Air Primary	6I-0273		
Air Primary	7W-5495		
Air Secondary	1P-7360		
Air Secondary	6I-0274		
963B Track Loader			9B1L-UP
Engine Oil	1R-0739		
Fuel Primary	117-4089		
Fuel Primary	9M-2341		
Fuel Secondary	1R-0751		
Fuel Secondary	1R-0753		
Hydraulic	1R-0722	139-1536	4T-3134
Power Train	132-8876		
Air Primary	6I-0273		
Air Secondary	6I-0274		
963C Track Loader			2DS1-UP
Engine Oil	1R-0739		
Fuel Primary	117-4089		
Fuel Secondary	1R-0751		
Fuel Secondary	1R-0753		
Hydraulic	1R-0722	139-1536	4T-3134
Power Train	108-1153	126-1817	134-3014
Power Train	4T-6788	144-0832	
Air Primary	6I-0273		
Air Secondary	6I-0274		
973 Track Loader			3Z1-UP
Engine Oil	1R-0739		
Fuel Primary	9M-2341		
Fuel Secondary	1R-0750		
Hydraulic	1R-0722	139-1536	4T-3134

FILTER TYPE	PART NUMBER	HIGH EFFICIENCY	FIRE RESISTANT
973 Track Loader (cont.)			32Z1-UP
Power Train	1R-0741	132-8876	4T-3132
Air Primary	7W-5495		
Air Secondary	1P-7360		
973 Track Loader			66G1-UP
Engine Oil	1R-0739		
Fuel Primary	9M-2341		
Fuel Secondary	1R-0750		
Hydraulic	1R-0722	139-1536	4T-3134
Power Train	132-8876		
Air Primary	7W-5495		
Air Secondary	1P-7360		
973 Track Loader			90L1-UP
Engine Oil	1R-0739		
Fuel Primary	9M-2341		
Fuel Secondary	1R-0750		
Hydraulic	1R-0722	139-1536	4T-3134
Power Train	1R-0741	132-8876	4T-3132
Air Primary	7W-5495		
Air Secondary	1P-7360		
973 Track Loader			91L1-UP
Engine Oil	1R-0739		
Fuel Primary	9M-2341		
Fuel Secondary	1R-0750		
Hydraulic	1R-0722	139-1536	4T-3134
Power Train	1R-0741	132-8876	4T-3132
Air Primary	7W-5495		
Air Secondary	1P-7360		
973 LGP Track Loader			26Z1-UP
Engine Oil	1R-0739		
Fuel Primary	9M-2341		
Fuel Secondary	1R-0750		
Hydraulic	1R-0722	139-1536	4T-3134
Power Train	1R-0741	132-8876	4T-3132
Air Primary	7W-5495		
Air Secondary	1P-7360		
973 LGP Track Loader			86G1-UP
Engine Oil	1R-0739		
Fuel Primary	9M-2341		
Fuel Secondary	1R-0750		
Hydraulic	1R-0722	139-1536	4T-3134
Power Train	132-8876		
Air Primary	6I-0273		
Air Secondary	6I-0274		
973C Track Loader			3RZ1-UP
Engine Oil	1R-0739		
Fuel Primary	9M-2341		
Fuel Secondary	1R-0750		

a - For quantities, refer to parts book.

Filters - Track Loaders, Track-Type Tractors

FILTER TYPE	PART NUMBER	HIGH EFFICIENCY	FIRE RESISTANT
973C Track Loader (cont.)			3RZ1-UP
Hydraulic	1R-0722	139-1536	4T-3134
Power Train	108-1153	126-1817	134-3014
Air Primary	6I-0273		
Air Secondary	6I-0274		
TRACK-TYPE TRACTORS ^a			
D3B Track-Type Tractor			2PC1-UP
Engine Oil	1R-0714		
Fuel Secondary	1R-0750		
Hydraulic	1R-0719	132-8875	4T-3131
Power Train	1R-0746	126-1810	
Air Primary	7W-5317		
Air Secondary	9S-9972		
D3B Track-Type Tractor			3YC1-UP
Engine Oil	1R-0713		
Fuel Secondary	1R-0710		
Fuel Secondary	1R-0750		
Hydraulic	1R-0719	132-8875	4T-3131
Power Train	1R-0746	126-1810	
Air Primary	4N-0326		
Air Secondary	4N-0313		
D3B Track-Type Tractor			5MC1-UP
Engine Oil	1R-0713		
Fuel Secondary	1R-0710		
Fuel Secondary	1R-0750		
Hydraulic	1R-0719	132-8875	4T-3131
Power Train	1R-0746	126-1810	
Air Primary	4N-0326		
Air Secondary	4N-0313		
D3B LGP Track-Type Tractor			3YC1-UP
Engine Oil	1R-0713		
Fuel Secondary	1R-0710		
Fuel Secondary	1R-0750		
Hydraulic	1R-0719	132-8875	4T-3131
Power Train	1R-0746	126-1810	
Air Primary	4N-0326		
Air Secondary	4N-0313		
D3B LGP Track-Type Tractor			5MC1-UP
Engine Oil	1R-0713		
Fuel Secondary	1R-0710		
Fuel Secondary	1R-0750		
Hydraulic	1R-0719	132-8875	4T-3131
Power Train	1R-0746	126-1810	
Air Primary	4N-0326		
Air Secondary	4N-0313		
D3C Track-Type Tractor			1PJ1-UP
Engine Oil	1R-0713		
Fuel Secondary	1R-0750		

FILTER TYPE	PART NUMBER	HIGH EFFICIENCY	FIRE RESISTANT
D3C Track-Type Tractor (cont.)			1PJ1-UP
Hydraulic	1R-0719	132-8875	4T-3131
Power Train	1R-0746	126-1810	
Air Primary	4N-0326		
Air Secondary	4N-0313		
D3C Track-Type Tractor			3RF1-UP
Engine Oil	1R-0713		
Fuel Secondary	1R-0750		
Hydraulic	1R-0719	132-8875	4T-3131
Air Primary	4N-0326		
Air Secondary	4N-0313		
D3C Track-Type Tractor			4HJ1-UP
Engine Oil	1R-0713		
Fuel Secondary	1R-0750		
Hydraulic	1R-0719	132-8875	4T-3131
Power Train	1R-0746	126-1810	
Air Primary	4N-0326		
Air Secondary	4N-0313		
D3C Track-Type Tractor			4KS1-UP
Engine Oil	1R-0734		
Fuel Primary	118-5768		
Fuel Secondary	5I-7951		
Power Train	1G-8878	102-2828	156-0214
Air Primary	4N-0326		
Air Secondary	4N-0313		
D3C Track-Type Tractor			4TS1-UP
Engine Oil	1R-0734		
Fuel Primary	118-5768		
Fuel Secondary	5I-7951		
Power Train	1G-8878	102-2828	156-0214
Air Primary	4N-0326		
Air Secondary	4N-0313		
D3C Track-Type Tractor			5CJ1-UP
Engine Oil	1R-0713		
Fuel Secondary	1R-0750		
Hydraulic	1R-0719	132-8875	4T-3131
Power Train	1R-0746	126-1810	
Air Primary	4N-0326		
Air Secondary	4N-0313		
D3C Track-Type Tractor			5GS1-UP
Engine Oil	1R-0734		
Fuel Primary	118-5768		
Fuel Secondary	5I-7951		
Power Train	1G-8878	102-2828	156-0214
Air Primary	4N-0326		
Air Secondary	4N-0313		
D3C Track-Type Tractor			5KG1-UP
Engine Oil	1R-0713		

a - For quantities, refer to parts book.

Filters - Track-Type Tractors

FILTER TYPE	PART NUMBER	HIGH EFFICIENCY	FIRE RESISTANT
D3C Track-Type Tractor (cont.)			5KG1-UP
Fuel Secondary	1R-0750		
Hydraulic	1R-0719	132-8875	4T-3131
Power Train	1R-0746	126-1810	
Air Primary	4N-0326		
Air Secondary	4N-0313		
D3C Track-Type Tractor			6PF1-UP
Engine Oil	1R-0713		
Fuel Secondary	1R-0750		
Hydraulic	1R-0719	132-8875	4T-3131
Air Primary	4N-0326		
Air Secondary	4N-0313		
D3C Track-Type Tractor			6SL1-UP
Engine Oil	1R-0734		
Fuel Primary	118-5768		
Fuel Secondary	5I-7951		
Hydraulic	1R-0719	132-8875	4T-3131
Power Train	1R-0746	126-1810	
Air Primary	4N-0326		
Air Secondary	4N-0313		
D3C Track-Type Tractor			7JF1-UP
Engine Oil	1R-0714		
Fuel Secondary	1R-0750		
Hydraulic	1R-0719	132-8875	4T-3131
Power Train	1R-0746	126-1810	
Air Primary	7W-5317		
Air Secondary	9S-9972		
D3C Track-Type Tractor			7JG1-UP
Engine Oil	1R-0713		
Fuel Secondary	1R-0750		
Hydraulic	1R-0719	132-8875	4T-3131
Air Primary	4N-0326		
Air Secondary	4N-0313		
D3C Track-Type Tractor			7XL1-UP
Engine Oil	1R-0734		
Fuel Primary	118-5768		
Fuel Secondary	5I-7951		
Hydraulic	1R-0719	132-8875	4T-3131
Power Train	1R-0746	126-1810	
Air Primary	4N-0326		
Air Secondary	4N-0313		
D3C Track-Type Tractor			8DG1-UP
Engine Oil	1R-0713		
Fuel Secondary	1R-0750		
Hydraulic	1R-0719	132-8875	4T-3131
Air Primary	4N-0326		
Air Secondary	4N-0313		

FILTER TYPE	PART NUMBER	HIGH EFFICIENCY	FIRE RESISTANT
D3C Track-Type Tractor			9TS1-UP
Engine Oil	1R-0734		
Fuel Primary	118-5768		
Fuel Secondary	5I-7951		
Power Train	1R-0746	126-1810	
Air Primary	4N-0326		
Air Secondary	4N-0313		
D3C LGP Track-Type Tractor			1PJ1-UP
Engine Oil	1R-0713		
Fuel Secondary	1R-0750		
Hydraulic	1R-0719	132-8875	4T-3131
Power Train	1R-0746	126-1810	
Air Primary	4N-0326		
Air Secondary	4N-0313		
D3C LGP Track-Type Tractor			3RF1-UP
Engine Oil	1R-0713		
Fuel Secondary	1R-0750		
Hydraulic	1R-0719	132-8875	4T-3131
Air Primary	4N-0326		
Air Secondary	4N-0313		
D3C LGP Track-Type Tractor			5KG1-UP
Engine Oil	1R-0713		
Fuel Secondary	1R-0750		
Hydraulic	1R-0719	132-8875	4T-3131
Power Train	1R-0746	126-1810	
Air Primary	4N-0326		
Air Secondary	4N-0313		
D3C LGP Track-Type Tractor			6PF1-UP
Engine Oil	1R-0713		
Fuel Secondary	1R-0750		
Hydraulic	1R-0719	132-8875	4T-3131
Air Primary	4N-0326		
Air Secondary	4N-0313		
D3C LGP Track-Type Tractor			8BF1-UP
Engine Oil	1R-0713		
Fuel Secondary	1R-0750		
Hydraulic	1R-0719	132-8875	4T-3131
Power Train	1R-0746	126-1810	
Air Primary	4N-0326		
Air Secondary	4N-0313		
D3C LGP Series II Track-Type Tractor			4HJ1-UP
Engine Oil	1R-0713		
Fuel Secondary	1R-0750		
Hydraulic	1R-0719	132-8875	4T-3131
Power Train	1R-0746	126-1810	
Air Primary	4N-0326		
Air Secondary	4N-0313		

a - For quantities, refer to parts book.

Filters - Track-Type Tractors

FILTER TYPE	PART NUMBER	HIGH EFFICIENCY	FIRE RESISTANT
D3C LGP Series II Track-Type Tractor			5CJ1-UP
Engine Oil	1R-0713		
Fuel Secondary	1R-0750		
Hydraulic	1R-0719	132-8875	4T-3131
Power Train	1R-0746	126-1810	
Air Primary	4N-0326		
Air Secondary	4N-0313		
D3C LGP Series II Track-Type Tractor			5ZG1-UP
Engine Oil	1R-0713		
Fuel Secondary	1R-0750		
Hydraulic	1R-0719	132-8875	4T-3131
Power Train	1R-0746	126-1810	
Air Primary	4N-0326		
Air Secondary	4N-0313		
D3C LGP Series II Track-Type Tractor			7JG1-UP
Engine Oil	1R-0713		
Fuel Secondary	1R-0750		
Hydraulic	1R-0719	132-8875	4T-3131
Air Primary	4N-0326		
Air Secondary	4N-0313		
D3C LGP Series II Track-Type Tractor			8DG1-UP
Engine Oil	1R-0713		
Fuel Secondary	1R-0750		
Hydraulic	1R-0719	132-8875	4T-3131
Air Primary	4N-0326		
Air Secondary	4N-0313		
D3C LGP XL Series III Track-Type Tractor			4KS1-UP
Engine Oil	1R-0734		
Fuel Primary	118-5768		
Fuel Secondary	5I-7951		
Power Train	1G-8878	102-2828	156-0214
Air Primary	4N-0326		
Air Secondary	4N-0313		
D3C LGP XL Series III Track-Type Tractor			4TS1-UP
Engine Oil	1R-0734		
Fuel Primary	118-5768		
Fuel Secondary	5I-7951		
Power Train	1G-8878	102-2828	156-0214
Air Primary	4N-0326		
Air Secondary	4N-0313		
D3C LGP XL Series III Track-Type Tractor			5GS1-UP
Engine Oil	1R-0734		
Fuel Primary	118-5768		
Fuel Secondary	5I-7951		
Power Train	1G-8878	102-2828	156-0214
Air Primary	4N-0326		
Air Secondary	4N-0313		

FILTER TYPE	PART NUMBER	HIGH EFFICIENCY	FIRE RESISTANT
D3C LGP XL Series III Track-Type Tractor			6SL1-UP
Engine Oil	1R-0734		
Fuel Primary	118-5768		
Fuel Secondary	5I-7951		
Hydraulic	1R-0719	132-8875	4T-3131
Power Train	1R-0746	126-1810	
Air Primary	4N-0326		
Air Secondary	4N-0313		
D3C LGP XL Series III Track-Type Tractor			7XL1-UP
Engine Oil	1R-0734		
Fuel Primary	118-5768		
Fuel Secondary	5I-7951		
Hydraulic	1R-0719	132-8875	4T-3131
Power Train	1R-0746	126-1810	
Air Primary	4N-0326		
Air Secondary	4N-0313		
D3C LGP XL Series III Track-Type Tractor			9TS1-UP
Engine Oil	1R-0734		
Fuel Primary	118-5768		
Fuel Secondary	5I-7951		
Power Train	1R-0746	126-1810	
Air Primary	4N-0326		
Air Secondary	4N-0313		
D4B Track-Type Tractor			1SG1-UP
Engine Oil	1R-0713		
Fuel Secondary	1R-0710		
Hydraulic	1R-0719	132-8875	4T-3131
Power Train	1R-0746	126-1810	
Air Primary	4N-0326		
Air Secondary	4N-0313		
D4B Track-Type Tractor			2XF1-UP
Engine Oil	1R-0713		
Fuel Secondary	1R-0710		
Hydraulic	1R-0719	132-8875	4T-3131
Power Train	1R-0746	126-1810	
Air Primary	4N-0326		
Air Secondary	4N-0313		
D4C Track-Type Tractor			1FW1-UP
Engine Oil	1R-0734		
Fuel Primary	118-5768		
Fuel Secondary	5I-7951		
Hydraulic	1R-0719	132-8875	4T-3131
Power Train	1R-0746	126-1810	
Air Primary	4N-0326		
Air Secondary	4N-0313		
D4C Track-Type Tractor			1RJ1-UP
Engine Oil	1R-0713		
Fuel Secondary	1R-0750		

a - For quantities, refer to parts book.

Filters - Track-Type Tractors

FILTER TYPE	PART NUMBER	HIGH EFFICIENCY	FIRE RESISTANT
D4C Track-Type Tractor (cont.)			1RJ1-UP
Hydraulic	1R-0719	132-8875	4T-3131
Power Train	1R-0746	126-1810	
Air Primary	4N-0326		
Air Secondary	4N-0313		
D4C Track-Type Tractor			2CJ1-UP
Engine Oil	1R-0713		
Fuel Secondary	1R-0750		
Hydraulic	1R-0719	132-8875	4T-3131
Power Train	1R-0746	126-1810	
Air Primary	4N-0326		
Air Secondary	4N-0313		
D4C Track-Type Tractor			4LS1-UP
Engine Oil	1R-0734		
Fuel Primary	118-5768		
Fuel Secondary	5I-7951		
Power Train	1G-8878	102-2828	156-0214
Air Primary	4N-0326		
Air Secondary	4N-0313		
D4C Track-Type Tractor			6BS1-UP
Engine Oil	1R-0734		
Fuel Primary	118-5768		
Fuel Secondary	5I-7951		
Power Train	1G-8878	102-2828	156-0214
Air Primary	4N-0326		
Air Secondary	4N-0313		
D4C Track-Type Tractor			6YL1-UP
Engine Oil	1R-0734		
Fuel Primary	118-5768		
Fuel Secondary	5I-7951		
Hydraulic	1R-0719	132-8875	4T-3131
Power Train	1R-0746	126-1810	
Air Primary	4N-0326		
Air Secondary	4N-0313		
D4C Track-Type Tractor			7KG1-UP
Engine Oil	1R-0713		
Fuel Secondary	1R-0750		
Hydraulic	1R-0719	132-8875	4T-3131
Power Train	1R-0746	126-1810	
Air Primary	4N-0326		
Air Secondary	4N-0313		
D4C Track-Type Tractor			7SL1-UP
Engine Oil	1R-0734		
Fuel Primary	118-5768		
Fuel Secondary	5I-7951		
Hydraulic	1R-0719	132-8875	4T-3131
Power Train	1R-0746	126-1810	
Air Primary	4N-0326		

FILTER TYPE	PART NUMBER	HIGH EFFICIENCY	FIRE RESISTANT
D4C Track-Type Tractor (cont.)			7SL1-UP
Air Secondary	4N-0313		
D4C Track-Type Tractor			8CS1-UP
Engine Oil	1R-0734		
Fuel Primary	118-5768		
Fuel Secondary	5I-7951		
Power Train	1G-8878	102-2828	156-0214
Air Primary	4N-0326		
Air Secondary	4N-0313		
D4C Track-Type Tractor			9BG1-UP
Engine Oil	1R-0713		
Fuel Secondary	1R-0750		
Hydraulic	1R-0719	132-8875	4T-3131
Power Train	1R-0746	126-1810	
Air Primary	4N-0326		
Air Secondary	4N-0313		
D4C LGP Track-Type Tractor			1RJ1-UP
Engine Oil	1R-0713		
Fuel Secondary	1R-0750		
Hydraulic	1R-0719	132-8875	4T-3131
Power Train	1R-0746	126-1810	
Air Primary	4N-0326		
Air Secondary	4N-0313		
D4C LGP Track-Type Tractor			2CJ1-UP
Engine Oil	1R-0713		
Fuel Secondary	1R-0750		
Hydraulic	1R-0719	132-8875	4T-3131
Power Train	1R-0746	126-1810	
Air Primary	4N-0326		
Air Secondary	4N-0313		
D4C LGP Series II Track-Type Tractor			7KG1-UP
Engine Oil	1R-0713		
Fuel Secondary	1R-0750		
Hydraulic	1R-0719	132-8875	4T-3131
Power Train	1R-0746	126-1810	
Air Primary	4N-0326		
Air Secondary	4N-0313		
D4C LGP Series II Track-Type Tractor			9BG1-UP
Engine Oil	1R-0713		
Fuel Secondary	1R-0750		
Hydraulic	1R-0719	132-8875	4T-3131
Power Train	1R-0746	126-1810	
Air Primary	4N-0326		
Air Secondary	4N-0313		
D4C LGP XL Series III Track-Type Tractor			1FW1-UP
Engine Oil	1R-0734		
Fuel Primary	118-5768		
Fuel Secondary	5I-7951		

a - For quantities, refer to parts book.

Filters - Track-Type Tractors

FILTER TYPE	PART NUMBER	HIGH EFFICIENCY	FIRE RESISTANT
D4C LGP XL Series III Track-Type Tractor (cont.)			1FW1-UP
Hydraulic	1R-0719	132-8875	4T-3131
Power Train	1R-0746	126-1810	
Air Primary	4N-0326		
Air Secondary	4N-0313		
D4C LGP XL Series III Track-Type Tractor			4LS1-UP
Engine Oil	1R-0734		
Fuel Primary	118-5768		
Fuel Secondary	5I-7951		
Power Train	1G-8878	102-2828	156-0214
Air Primary	4N-0326		
Air Secondary	4N-0313		
D4C LGP XL Series III Track-Type Tractor			6BS1-UP
Engine Oil	1R-0734		
Fuel Primary	118-5768		
Fuel Secondary	5I-7951		
Power Train	1G-8878	102-2828	156-0214
Air Primary	4N-0326		
Air Secondary	4N-0313		
D4C LGP XL Series III Track-Type Tractor			6YL1-UP
Engine Oil	1R-0734		
Fuel Primary	118-5768		
Fuel Secondary	5I-7951		
Hydraulic	1R-0719	132-8875	4T-3131
Power Train	1R-0746	126-1810	
Air Primary	4N-0326		
Air Secondary	4N-0313		
D4C LGP XL Series III Track-Type Tractor			7SL1-UP
Engine Oil	1R-0734		
Fuel Primary	118-5768		
Fuel Secondary	5I-7951		
Hydraulic	1R-0719	132-8875	4T-3131
Power Train	1R-0746	126-1810	
Air Primary	4N-0326		
Air Secondary	4N-0313		
D4C LGP XL Series III Track-Type Tractor			8CS1-UP
Engine Oil	1R-0734		
Fuel Primary	118-5768		
Fuel Secondary	5I-7951		
Power Train	1G-8878	102-2828	156-0214
Air Primary	4N-0326		
Air Secondary	4N-0313		
D4E Track-Type Tractor			2CB1-UP
Engine Oil	1R-0739		
Fuel Primary	8N-9803		
Fuel Primary	9M-2341		
Fuel Secondary	1R-0750		
Hydraulic	1R-0719	132-8875	4T-3131

FILTER TYPE	PART NUMBER	HIGH EFFICIENCY	FIRE RESISTANT
D4E Track-Type Tractor (cont.)			2CB1-UP
Power Train	1R-0719	132-8875	4T-3131
Air Primary	7W-5317		
Air Primary	7W-5389		
Air Secondary	2S-1286		
Air Secondary	8N-4901		
D4E Track-Type Tractor			7PB1-UP
Engine Oil	1R-0739		
Fuel Primary	9M-2341		
Fuel Secondary	1R-0750		
Hydraulic	1R-0719	132-8875	4T-3131
Power Train	1R-0719	132-8875	4T-3131
Air Primary	7W-5317		
Air Primary	7W-5389		
Air Secondary	2S-1286		
Air Secondary	8N-4901		
D4E Track-Type Tractor			31C100-UP
Engine Oil	1R-0739		
Fuel Primary	9M-2341		
Fuel Secondary	1R-0750		
Hydraulic	1R-0719	132-8875	4T-3131
Power Train	1R-0719	132-8875	4T-3131
Air Primary	7W-5389		
Air Secondary	2S-1285		
D4E Track-Type Tractor			34C100-UP
Engine Oil	1R-0739		
Fuel Secondary	1R-0750		
Hydraulic	1R-0719	132-8875	4T-3131
Power Train	1R-0719	132-8875	4T-3131
Air Primary	7W-5389		
Air Secondary	2S-1285		
D4E Track-Type Tractor			51X1-841
Engine Oil	1R-0739		
Fuel Primary	5S-7645		
Fuel Secondary	1R-0750		
Hydraulic	1R-0719	132-8875	4T-3131
Air Primary	7W-5389		
Air Secondary	2S-1285		
D4E Track-Type Tractor			51X842-UP
Engine Oil	1R-0739		
Fuel Secondary	1R-0750		
Hydraulic	1R-0719	132-8875	4T-3131
Power Train	1R-0719	132-8875	4T-3131
Air Primary	7W-5389		
Air Secondary	2S-1285		
D4E SR Track-Type Tractor			2DJ1-1399
Engine Oil	1R-0739		
Fuel Primary	9M-2341		

a - For quantities, refer to parts book.

Filters - Track-Type Tractors

FILTER TYPE	PART NUMBER	HIGH EFFICIENCY	FIRE RESISTANT
D4E SR Track-Type Tractor (cont.)			2DJ1-1399
Fuel Secondary	1R-0750		
Hydraulic	1R-0719	132-8875	4T-3131
Air Primary	6I-2499		
Air Secondary	6I-2500		
D4E SR Track-Type Tractor			2DJ1400-UP
Engine Oil	1R-0739		
Fuel Primary	9M-2341		
Fuel Secondary	1R-0750		
Hydraulic	1R-0719	132-8875	4T-3131
Hydraulic	9T-0973	126-1817	134-3014
Air Primary	6I-2499		
Air Secondary	6I-2500		
D4H Track-Type Tractor			2AC1-3999
Engine Oil	1R-0714		
Fuel Secondary	1R-0750		
Hydraulic	1R-0719	132-8875	4T-3131
Hydraulic	1R-0746	126-1810	
Power Train	1R-0719	132-8875	4T-3131
Air Primary	7W-5389		
Air Secondary	8N-4901		
D4H Track-Type Tractor			2AC4000-UP
Engine Oil	1R-0714		
Fuel Primary	9M-2341		
Fuel Secondary	1R-0750		
Hydraulic	1R-0719	132-8875	4T-3131
Power Train	1R-0719	132-8875	4T-3131
Air Primary	7W-5389		
Air Secondary	8N-4901		
D4H Track-Type Tractor			3AC1-3999
Engine Oil	1R-0714		
Fuel Secondary	1R-0750		
Hydraulic	1R-0719	132-8875	4T-3131
Hydraulic	1R-0746	126-1810	
Power Train	1R-0719	132-8875	4T-3131
Air Primary	7W-5389		
Air Secondary	8N-4901		
D4H Track-Type Tractor			3AC4000-UP
Engine Oil	1R-0714		
Fuel Primary	9M-2341		
Fuel Secondary	1R-0750		
Hydraulic	1R-0719	132-8875	4T-3131
Power Train	1R-0719	132-8875	4T-3131
Air Primary	7W-5389		
Air Secondary	8N-4901		
D4H Track-Type Tractor			8PB1-3999
Engine Oil	1R-0714		
Fuel Secondary	1R-0750		

FILTER TYPE	PART NUMBER	HIGH EFFICIENCY	FIRE RESISTANT
D4H Track-Type Tractor (cont.)			8PB1-3999
Hydraulic	1R-0719	132-8875	4T-3131
Hydraulic	1R-0746	126-1810	
Power Train	1R-0719	132-8875	4T-3131
Air Primary	7W-5389		
Air Secondary	8N-4901		
D4H Track-Type Tractor			8PB4000-UP
Engine Oil	1R-0714		
Fuel Primary	9M-2341		
Fuel Secondary	1R-0750		
Hydraulic	1R-0719	132-8875	4T-3131
Hydraulic	1R-0746	126-1810	
Power Train	1R-0719	132-8875	4T-3131
Air Primary	7W-5389		
Air Secondary	8N-4901		
D4H Track-Type Tractor			9DB1-3999
Engine Oil	1R-0714		
Fuel Secondary	1R-0750		
Hydraulic	1R-0719	132-8875	4T-3131
Hydraulic	1R-0746	126-1810	
Power Train	1R-0719	132-8875	4T-3131
Air Primary	7W-5389		
Air Secondary	8N-4901		
D4H Track-Type Tractor			9DB4000-UP
Engine Oil	1R-0714		
Fuel Primary	9M-2341		
Fuel Secondary	1R-0750		
Hydraulic	1R-0719	132-8875	4T-3131
Hydraulic	1R-0746	126-1810	
Power Train	1R-0719	132-8875	4T-3131
Air Primary	7W-5389		
Air Secondary	8N-4901		
D4H LGP Track-Type Tractor			2AC1-3999
Engine Oil	1R-0714		
Fuel Secondary	1R-0750		
Hydraulic	1R-0719	132-8875	4T-3131
Hydraulic	1R-0746	126-1810	
Power Train	1R-0719	132-8875	4T-3131
Air Primary	7W-5389		
Air Secondary	8N-4901		
D4H LGP Track-Type Tractor			3AC1-3999
Engine Oil	1R-0714		
Fuel Secondary	1R-0750		
Hydraulic	1R-0719	132-8875	4T-3131
Hydraulic	1R-0746	126-1810	
Power Train	1R-0719	132-8875	4T-3131
Air Primary	7W-5389		
Air Secondary	8N-4901		

a - For quantities, refer to parts book.

Filters - Track-Type Tractors

FILTER TYPE	PART NUMBER	HIGH EFFICIENCY	FIRE RESISTANT
D4H LGP Track-Type Tractor		4NK1-UP	
Engine Oil	1R-0739		
Fuel Secondary	1R-0750		
Hydraulic	132-8875		
Hydraulic	1R-0719	132-8875	4T-3131
Hydraulic	1R-0746	126-1810	
Power Train	1R-0719	132-8875	4T-3131
Air Primary	6I-2499		
Air Primary	7W-5389		
Air Secondary	6I-2500		
Air Secondary	8N-4901		
D4H LGP Track-Type Tractor		8PB1-3999	
Engine Oil	1R-0714		
Fuel Secondary	1R-0750		
Hydraulic	1R-0719	132-8875	4T-3131
Hydraulic	1R-0746	126-1810	
Power Train	1R-0719	132-8875	4T-3131
Air Primary	7W-5389		
Air Secondary	8N-4901		
D4H LGP Track-Type Tractor		9DB1-3999	
Engine Oil	1R-0714		
Fuel Secondary	1R-0750		
Hydraulic	1R-0719	132-8875	4T-3131
Hydraulic	1R-0746	126-1810	
Power Train	1R-0719	132-8875	4T-3131
Air Primary	7W-5389		
Air Secondary	8N-4901		
D4H LGP Series II Track-Type Tractor		2AC4000-UP	
Engine Oil	1R-0714		
Fuel Primary	9M-2341		
Fuel Secondary	1R-0750		
Hydraulic	1R-0719	132-8875	4T-3131
Power Train	1R-0719	132-8875	4T-3131
Air Primary	7W-5389		
Air Secondary	8N-4901		
D4H LGP Series II Track-Type Tractor		3AC4000-UP	
Engine Oil	1R-0714		
Fuel Primary	9M-2341		
Fuel Secondary	1R-0750		
Hydraulic	1R-0719	132-8875	4T-3131
Power Train	1R-0719	132-8875	4T-3131
Air Primary	7W-5389		
Air Secondary	8N-4901		
D4H LGP Series II Track-Type Tractor		8PB4000-UP	
Engine Oil	1R-0714		
Fuel Primary	9M-2341		
Fuel Secondary	1R-0750		
Hydraulic	1R-0719	132-8875	4T-3131

FILTER TYPE	PART NUMBER	HIGH EFFICIENCY	FIRE RESISTANT
D4H LGP Series II Track-Type Tractor (cont.)		8PB4000-UP	
Hydraulic	1R-0746	126-1810	
Power Train	1R-0719	132-8875	4T-3131
Air Primary	7W-5389		
Air Secondary	8N-4901		
D4H LGP Series II Track-Type Tractor		9DB4000-UP	
Engine Oil	1R-0714		
Fuel Primary	9M-2341		
Fuel Secondary	1R-0750		
Hydraulic	1R-0719	132-8875	4T-3131
Hydraulic	1R-0746	126-1810	
Power Train	1R-0719	132-8875	4T-3131
Air Primary	7W-5389		
Air Secondary	8N-4901		
D4H LGP Series III Track-Type Tractor		8PJ1-UP	
Engine Oil	1R-0739		
Fuel Primary	9M-2341		
Fuel Secondary	1R-0750		
Hydraulic	1R-0719	132-8875	4T-3131
Hydraulic	1R-0746	126-1810	
Power Train	132-8875		
Air Primary	6I-2499		
Air Primary	7W-5389		
Air Secondary	6I-2500		
Air Secondary	8N-4901		
D4H LGP Series III Track-Type Tractor		9GJ1-UP	
Engine Oil	1R-0739		
Fuel Primary	9M-2341		
Fuel Secondary	1R-0750		
Hydraulic	1R-0719	132-8875	4T-3131
Hydraulic	1R-0746	126-1810	
Power Train	132-8875		
Air Primary	6I-2499		
Air Primary	7W-5389		
Air Secondary	6I-2500		
Air Secondary	8N-4901		
D4H XL Track-Type Tractor		8PJ1-UP	
Engine Oil	1R-0739		
Fuel Primary	9M-2341		
Fuel Secondary	1R-0750		
Hydraulic	1R-0719	132-8875	4T-3131
Hydraulic	1R-0746	126-1810	
Power Train	132-8875		
Air Primary	6I-2499		
Air Primary	7W-5389		
Air Secondary	6I-2500		
Air Secondary	8N-4901		

a - For quantities, refer to parts book.

Filters - Track-Type Tractors

FILTER TYPE	PART NUMBER	HIGH EFFICIENCY	FIRE RESISTANT
D4H XL Track-Type Tractor			9GJ1-UP
Engine Oil	1R-0739		
Fuel Primary	9M-2341		
Fuel Secondary	1R-0750		
Hydraulic	1R-0719	132-8875	4T-3131
Hydraulic	1R-0746	126-1810	
Power Train	132-8875		
Air Primary	6I-2499		
Air Primary	7W-5389		
Air Secondary	6I-2500		
Air Secondary	8N-4901		
D5B Track-Type Tractor			5LD1-UP
Engine Oil	1R-0739		
Fuel Primary	9M-2341		
Fuel Secondary	1R-0750		
Hydraulic	1R-0728	139-1532	4T-3130
Power Train	1R-0719	132-8875	4T-3131
Air Primary	7W-5317		
Air Secondary	2S-1286		
D5B Track-Type Tractor			8HD1-620
Engine Oil	1R-0739		
Fuel Primary	9M-2341		
Fuel Secondary	1R-0750		
Hydraulic	1R-0728	139-1532	4T-3130
Power Train	1R-0719	132-8875	4T-3131
Air Primary	7W-5317		
Air Secondary	2S-1286		
D5B Track-Type Tractor			8MB1-UP
Engine Oil	1R-0739		
Fuel Primary	8N-9803		
Fuel Secondary	1R-0750		
Hydraulic	1R-0728	139-1532	4T-3130
Hydraulic	1R-0746	126-1810	
Power Train	1R-0719	132-8875	4T-3131
Air Primary	7W-5317		
Air Secondary	2S-1286		
D5B Track-Type Tractor			47X1-UP
Engine Oil	1R-0739		
Fuel Primary	5S-7645		
Fuel Secondary	1R-0750		
Hydraulic	1R-0728	139-1532	4T-3130
Power Train	1R-0719	132-8875	4T-3131
Air Primary	7W-5317		
Air Secondary	2S-1286		
D5B Track-Type Tractor			48X1-UP
Engine Oil	1R-0739		
Fuel Primary	5S-7645		
Fuel Secondary	1R-0750		

FILTER TYPE	PART NUMBER	HIGH EFFICIENCY	FIRE RESISTANT
D5B Track-Type Tractor (cont.)			48X1-UP
Hydraulic	1R-0728	139-1532	4T-3130
Power Train	1R-0719	132-8875	4T-3131
Air Primary	7W-5317		
Air Secondary	2S-1286		
D5C Track-Type Tractor			3MK1-UP
Engine Oil	1R-0713		
Fuel Secondary	1R-0750		
Hydraulic	1R-0719	132-8875	4T-3131
Power Train	1R-0746	126-1810	
Air Primary	4N-0326		
Air Secondary	4N-0313		
D5C Track-Type Tractor			5HS1-UP
Engine Oil	1R-0734		
Fuel Secondary	5I-7951		
Power Train	1G-8878	102-2828	156-0214
Air Primary	4N-0326		
Air Secondary	4N-0313		
D5C Track-Type Tractor			6CS1-UP
Engine Oil	1R-0734		
Fuel Secondary	5I-7951		
Power Train	1G-8878	102-2828	156-0214
Air Primary	4N-0326		
Air Secondary	4N-0313		
D5C Track-Type Tractor			6PJ1-UP
Engine Oil	1R-0713		
Fuel Secondary	1R-0750		
Hydraulic	1R-0719	132-8875	4T-3131
Power Train	1R-0746	126-1810	
Air Primary	4N-0326		
Air Secondary	4N-0313		
D5C Track-Type Tractor			6ZL1-UP
Engine Oil	1R-0734		
Fuel Secondary	5I-7951		
Hydraulic	1R-0719	132-8875	4T-3131
Power Train	1R-0746	126-1810	
Air Primary	4N-0326		
Air Secondary	4N-0313		
D5C Track-Type Tractor			7PS1-UP
Engine Oil	1R-0734		
Fuel Secondary	5I-7951		
Power Train	1G-8878	102-2828	156-0214
Air Primary	4N-0326		
Air Secondary	4N-0313		
D5C Track-Type Tractor			8ZS1-UP
Engine Oil	1R-0734		
Fuel Secondary	5I-7951		
Hydraulic	1R-0719	132-8875	4T-3131

a - For quantities, refer to parts book.

Filters - Track-Type Tractors

FILTER TYPE	PART NUMBER	HIGH EFFICIENCY	FIRE RESISTANT
D5C Track-Type Tractor (cont.)			8ZS1-UP
Power Train	1R-0746	126-1810	
Air Primary	4N-0326		
Air Secondary	4N-0313		
D5C Track-Type Tractor			9DL1-UP
Engine Oil	1R-0734		
Fuel Secondary	5I-7951		
Hydraulic	1R-0719	132-8875	4T-3131
Power Train	1R-0746	126-1810	
Air Primary	4N-0326		
Air Secondary	4N-0313		
D5C Series III Track-Type Tractor			9DL2550-2569
Engine Oil	1R-0734		
Fuel Secondary	5I-7951		
Hydraulic	1R-0719	132-8875	4T-3131
Power Train	1R-0746	126-1810	
Air Primary	4N-0326		
Air Secondary	4N-0313		
D5C LGP Track-Type Tractor			3MK1-UP
Engine Oil	1R-0713		
Fuel Secondary	1R-0750		
Hydraulic	1R-0719	132-8875	4T-3131
Power Train	1R-0746	126-1810	
Air Primary	4N-0326		
Air Secondary	4N-0313		
D5C LGP Track-Type Tractor			6PJ1-UP
Engine Oil	1R-0713		
Fuel Secondary	1R-0750		
Hydraulic	1R-0719	132-8875	4T-3131
Power Train	1R-0746	126-1810	
Air Primary	4N-0326		
Air Secondary	4N-0313		
D5C LGP XL Series III Track-Type Tractor			5HS1-UP
Engine Oil	1R-0734		
Fuel Secondary	5I-7951		
Power Train	1G-8878	102-2828	156-0214
Air Primary	4N-0326		
Air Secondary	4N-0313		
D5C LGP XL Series III Track-Type Tractor			6CS1-UP
Engine Oil	1R-0734		
Fuel Secondary	5I-7951		
Power Train	1G-8878	102-2828	156-0214
Air Primary	4N-0326		
Air Secondary	4N-0313		
D5C LGP XL Series III Track-Type Tractor			6ZL1-UP
Engine Oil	1R-0734		
Fuel Secondary	5I-7951		
Hydraulic	1R-0719	132-8875	4T-3131

FILTER TYPE	PART NUMBER	HIGH EFFICIENCY	FIRE RESISTANT
D5C LGP XL Series III Track-Type Tractor (cont.)			6ZL1-UP
Power Train	1R-0746	126-1810	
Air Primary	4N-0326		
Air Secondary	4N-0313		
D5C LGP XL Series III Track-Type Tractor			7PS1-UP
Engine Oil	1R-0734		
Fuel Secondary	5I-7951		
Power Train	1G-8878	102-2828	156-0214
Air Primary	4N-0326		
Air Secondary	4N-0313		
D5C LGP XL Series III Track-Type Tractor			8ZS1-UP
Engine Oil	1R-0734		
Fuel Secondary	5I-7951		
Hydraulic	1R-0719	132-8875	4T-3131
Power Train	1R-0746	126-1810	
Air Primary	4N-0326		
Air Secondary	4N-0313		
D5C LGP XL Series III Track-Type Tractor			9DL1-UP
Engine Oil	1R-0734		
Fuel Secondary	5I-7951		
Hydraulic	1R-0719	132-8875	4T-3131
Power Train	1R-0746	126-1810	
Air Primary	4N-0326		
Air Secondary	4N-0313		
D5E Track-Type Tractor			9RG1-UP
Engine Oil	1R-0739		
Fuel Primary	9M-2341		
Fuel Secondary	1R-0750		
Hydraulic	1R-0728	139-1532	4T-3130
Power Train	1R-0719	132-8875	4T-3131
Air Primary	6I-2501		
Air Primary	7W-5317		
Air Secondary	2S-1286		
Air Secondary	6I-2502		
D5H Track-Type Tractor			1DD1-3999
Engine Oil	1R-0739		
Fuel Primary	9M-2341		
Fuel Secondary	1R-0750		
Hydraulic	4T-6915		
Hydraulic	1R-0746	126-1810	
Power Train	1R-0719	132-8875	4T-3131
Air Primary	7W-5317		
Air Secondary	9S-9972		
D5H Track-Type Tractor			1DD4000-UP
Engine Oil	1R-0739		
Fuel Primary	9M-2341		
Fuel Secondary	1R-0750		
Hydraulic	4T-6915		

a - For quantities, refer to parts book.

Filters - Track-Type Tractors

FILTER TYPE	PART NUMBER	HIGH EFFICIENCY	FIRE RESISTANT
D5H Track-Type Tractor (cont.)			1DD4000-UP
Hydraulic	1R-0746	126-1810	
Power Train	1R-0719	132-8875	4T-3131
Air Primary	6I-2501		
Air Secondary	6I-2502		
D5H Track-Type Tractor			1YD1-4026
Fuel Primary	9M-2341		
Fuel Secondary	1R-0750		
Hydraulic	1R-0735	139-1537	104-6931
Hydraulic	1R-0746	126-1810	
Power Train	1R-0719	132-8875	4T-3131
Air Primary	7W-5317		
Air Secondary	9S-9972		
D5H Track-Type Tractor			1YD4027-UP
Fuel Primary	9M-2341		
Fuel Secondary	1R-0750		
Hydraulic	1R-0735	139-1537	104-6931
Hydraulic	1R-0746	126-1810	
Hydraulic	4T-6915		
Power Train	1R-0719	132-8875	4T-3131
Air Primary	7W-5317		
Air Secondary	9S-9972		
D5H Track-Type Tractor			2SD1-4078
Fuel Primary	9M-2341		
Fuel Secondary	1R-0750		
Hydraulic	1R-0735	139-1537	104-6931
Hydraulic	1R-0746	126-1810	
Power Train	1R-0719	132-8875	4T-3131
Air Primary	7W-5317		
Air Secondary	9S-9972		
D5H Track-Type Tractor			2SD4079-UP
Fuel Primary	9M-2341		
Fuel Secondary	1R-0750		
Hydraulic	1R-0735	139-1537	104-6931
Hydraulic	1R-0746	126-1810	
Hydraulic	4T-6915		
Power Train	1R-0719	132-8875	4T-3131
Air Primary	7W-5317		
Air Secondary	9S-9972		
D5H Track-Type Tractor			3MD1-4025
Fuel Primary	9M-2341		
Fuel Secondary	1R-0750		
Hydraulic	1R-0735	139-1537	104-6931
Hydraulic	1R-0746	126-1810	
Power Train	1R-0719	132-8875	4T-3131
Air Primary	7W-5317		
Air Secondary	9S-9972		

FILTER TYPE	PART NUMBER	HIGH EFFICIENCY	FIRE RESISTANT
D5H Track-Type Tractor			3MD4026-UP
Fuel Primary	9M-2341		
Fuel Secondary	1R-0750		
Hydraulic	1R-0735	139-1537	104-6931
Hydraulic	1R-0746	126-1810	
Hydraulic	4T-6915		
Power Train	1R-0719	132-8875	4T-3131
Air Primary	7W-5317		
Air Secondary	9S-9972		
D5H Track-Type Tractor			4KD1-4069
Fuel Primary	9M-2341		
Fuel Secondary	1R-0750		
Hydraulic	1R-0735	139-1537	104-6931
Hydraulic	1R-0746	126-1810	
Power Train	1R-0719	132-8875	4T-3131
Air Primary	7W-5317		
Air Secondary	9S-9972		
D5H Track-Type Tractor			4KD4070-UP
Fuel Primary	9M-2341		
Fuel Secondary	1R-0750		
Hydraulic	1R-0735	139-1537	104-6931
Hydraulic	1R-0746	126-1810	
Hydraulic	4T-6915		
Power Train	1R-0719	132-8875	4T-3131
Air Primary	7W-5317		
Air Secondary	9S-9972		
D5H Track-Type Tractor			7NC1-3999
Engine Oil	1R-0739		
Fuel Primary	9M-2341		
Fuel Secondary	1R-0750		
Hydraulic	4T-6915		
Hydraulic	1R-0746	126-1810	
Power Train	1R-0719	132-8875	4T-3131
Air Primary	7W-5317		
Air Secondary	9S-9972		
D5H Track-Type Tractor			7NC4000-UP
Engine Oil	1R-0739		
Fuel Primary	9M-2341		
Fuel Secondary	1R-0750		
Hydraulic	4T-6915		
Power Train	1R-0719	132-8875	4T-3131
Air Primary	6I-2501		
Air Secondary	6I-2502		
D5H Track-Type Tractor			8RC1-3999
Engine Oil	1R-0739		
Fuel Primary	9M-2341		
Fuel Secondary	1R-0750		
Hydraulic	4T-6915		

a - For quantities, refer to parts book.

Filters - Track-Type Tractors

FILTER TYPE	PART NUMBER	HIGH EFFICIENCY	FIRE RESISTANT
D5H Track-Type Tractor (cont.)		8RC1-3999	
Hydraulic	1R-0746	126-1810	
Power Train	1R-0719	132-8875	4T-3131
Air Primary	7W-5317		
Air Secondary	9S-9972		
D5H Track-Type Tractor		8RC4000-UP	
Engine Oil	1R-0739		
Fuel Primary	9M-2341		
Fuel Secondary	1R-0750		
Hydraulic	4T-6915		
Hydraulic	1R-0746	126-1810	
Power Train	1R-0719	132-8875	4T-3131
Air Primary	6I-2501		
Air Secondary	6I-2502		
D5H Track-Type Tractor		8SC1-UP	
Engine Oil	1R-0739		
Fuel Primary	9M-2341		
Fuel Secondary	1R-0750		
Hydraulic	4T-6915		
Hydraulic	1R-0746	126-1810	
Air Primary	7W-5317		
Air Secondary	9S-9972		
D5H Track-Type Tractor		9HC1-3999	
Engine Oil	1R-0739		
Fuel Primary	9M-2341		
Fuel Secondary	1R-0750		
Hydraulic	4T-6915		
Hydraulic	1R-0746	126-1810	
Power Train	1R-0719	132-8875	4T-3131
Air Primary	7W-5317		
Air Secondary	9S-9972		
D5H Track-Type Tractor		9HC4000-UP	
Engine Oil	1R-0739		
Fuel Primary	9M-2341		
Fuel Secondary	1R-0750		
Hydraulic	4T-6915		
Power Train	1R-0719	132-8875	4T-3131
Air Primary	6I-2501		
Air Secondary	6I-2502		
D5H LGP Track-Type Tractor		1DD1-3999	
Engine Oil	1R-0739		
Fuel Primary	9M-2341		
Fuel Secondary	1R-0750		
Hydraulic	4T-6915		
Hydraulic	1R-0746	126-1810	
Power Train	1R-0719	132-8875	4T-3131
Air Primary	7W-5317		
Air Secondary	9S-9972		

FILTER TYPE	PART NUMBER	HIGH EFFICIENCY	FIRE RESISTANT
D5H LGP Track-Type Tractor		1YD1-UP	
Fuel Primary	9M-2341		
Fuel Secondary	1R-0750		
Hydraulic	1R-0735	139-1537	104-6931
Hydraulic	1R-0746	126-1810	
Power Train	1R-0719	132-8875	4T-3131
Air Primary	7W-5317		
Air Secondary	9S-9972		
D5H LGP Track-Type Tractor		2SD1-UP	
Fuel Primary	9M-2341		
Fuel Secondary	1R-0750		
Hydraulic	1R-0735	139-1537	104-6931
Hydraulic	1R-0746	126-1810	
Power Train	1R-0719	132-8875	4T-3131
Air Primary	7W-5317		
Air Secondary	9S-9972		
D5H LGP Track-Type Tractor		3MD1-UP	
Fuel Primary	9M-2341		
Fuel Secondary	1R-0750		
Hydraulic	1R-0735	139-1537	104-6931
Hydraulic	1R-0746		
Power Train	1R-0719	132-8875	4T-3131
Air Primary	7W-5317		
Air Secondary	9S-9972		
D5H LGP Track-Type Tractor		4KD1-UP	
Fuel Primary	9M-2341		
Fuel Secondary	1R-0750		
Hydraulic	1R-0735	139-1537	104-6931
Hydraulic	1R-0746	126-1810	
Power Train	1R-0719	132-8875	4T-3131
Air Primary	7W-5317		
Air Secondary	9S-9972		
D5H LGP Track-Type Tractor		7NC1-3999	
Engine Oil	1R-0739		
Fuel Primary	9M-2341		
Fuel Secondary	1R-0750		
Hydraulic	4T-6915		
Hydraulic	1R-0746	126-1810	
Power Train	1R-0719	132-8875	4T-3131
Air Primary	7W-5317		
Air Secondary	9S-9972		
D5H LGP Track-Type Tractor		8RC1-3999	
Engine Oil	1R-0739		
Fuel Primary	9M-2341		
Fuel Secondary	1R-0750		
Hydraulic	4T-6915		
Hydraulic	1R-0746	126-1810	
Power Train	1R-0719	132-8875	4T-3131

a - For quantities, refer to parts book.

Filters - Track-Type Tractors

FILTER TYPE	PART NUMBER	HIGH EFFICIENCY	FIRE RESISTANT
D5H LGP Track-Type Tractor (cont.)			8RC1-3999
Air Primary	7W-5317		
Air Secondary	9S-9972		
D5H LGP Track-Type Tractor			8SC1-UP
Engine Oil	1R-0739		
Fuel Primary	9M-2341		
Fuel Secondary	1R-0750		
Hydraulic	4T-6915		
Hydraulic	1R-0746	126-1810	
Air Primary	7W-5317		
Air Secondary	9S-9972		
D5H LGP Track-Type Tractor			9HC1-3999
Engine Oil	1R-0739		
Fuel Primary	9M-2341		
Fuel Secondary	1R-0750		
Hydraulic	4T-6915		
Hydraulic	1R-0746	126-1810	
Power Train	1R-0719	132-8875	4T-3131
Air Primary	7W-5317		
Air Secondary	9S-9972		
D5H LGP Series II Track-Type Tractor			1DD4000-UP
Engine Oil	1R-0739		
Fuel Primary	9M-2341		
Fuel Secondary	1R-0750		
Hydraulic	4T-6915		
Hydraulic	1R-0746	126-1810	
Power Train	1R-0719	132-8875	4T-3131
Air Primary	6I-2501		
Air Primary	7W-5317		
Air Secondary	6I-2502		
Air Secondary	9S-9972		
D5H LGP Series II Track-Type Tractor			1YD4027-UP
Fuel Primary	9M-2341		
Fuel Secondary	1R-0750		
Hydraulic	1R-0735	139-1537	104-6931
Hydraulic	1R-0746	126-1810	
Hydraulic	4T-6915		
Power Train	1R-0719	132-8875	4T-3131
Air Primary	7W-5317		
Air Secondary	9S-9972		
D5H LGP Series II Track-Type Tractor			2SD4079-UP
Fuel Primary	9M-2341		
Fuel Secondary	1R-0750		
Hydraulic	1R-0735	139-1537	104-6931
Hydraulic	1R-0746	126-1810	
Hydraulic	4T-6915		
Power Train	1R-0719	132-8875	4T-3131
Air Primary	7W-5317		

FILTER TYPE	PART NUMBER	HIGH EFFICIENCY	FIRE RESISTANT
D5H LGP Series II Track-Type Tractor (cont.)			2SD4079-UP
Air Secondary	9S-9972		
D5H LGP Series II Track-Type Tractor			3MD4026-UP
Fuel Primary	9M-2341		
Fuel Secondary	1R-0750		
Hydraulic	1R-0735	139-1537	104-6931
Hydraulic	1R-0746	126-1810	
Hydraulic	4T-6915		
Power Train	1R-0719	132-8875	4T-3131
Air Primary	7W-5317		
Air Secondary	9S-9972		
D5H LGP Series II Track-Type Tractor			4KD4070-UP
Fuel Primary	9M-2341		
Fuel Secondary	1R-0750		
Hydraulic	1R-0735	139-1537	104-6931
Hydraulic	1R-0746	126-1810	
Hydraulic	4T-6915		
Power Train	1R-0719	132-8875	4T-3131
Air Primary	7W-5317		
Air Secondary	9S-9972		
D5H LGP Series II Track-Type Tractor			7NC4000-UP
Engine Oil	1R-0739		
Fuel Primary	9M-2341		
Fuel Secondary	1R-0750		
Hydraulic	4T-6915		
Power Train	1R-0719	132-8875	4T-3131
Air Primary	6I-2501		
Air Secondary	6I-2502		
D5H LGP Series II Track-Type Tractor			8RC4000-UP
Engine Oil	1R-0739		
Fuel Primary	9M-2341		
Fuel Secondary	1R-0750		
Hydraulic	4T-6915		
Hydraulic	1R-0746	126-1810	
Power Train	1R-0719	132-8875	4T-3131
Air Primary	6I-2501		
Air Secondary	6I-2502		
D5H LGP Series II Track-Type Tractor			9HC4000-UP
Engine Oil	1R-0739		
Fuel Primary	9M-2341		
Fuel Secondary	1R-0750		
Hydraulic	4T-6915		
Power Train	1R-0719	132-8875	4T-3131
Air Primary	6I-2501		
Air Secondary	6I-2502		
D5H XL Track-Type Tractor			8RJ1-UP
Engine Oil	1R-0739		
Fuel Primary	9M-2341		

a - For quantities, refer to parts book.

Filters - Track-Type Tractors

FILTER TYPE	PART NUMBER	HIGH EFFICIENCY	FIRE RESISTANT
D5H XL Track-Type Tractor (cont.)			8RJ1-UP
Fuel Secondary	1R-0750		
Hydraulic	4T-6915		
Hydraulic	1R-0746	126-1810	
Power Train	1R-0719	132-8875	4T-3131
Air Primary	6I-2501		
Air Secondary	6I-2502		
D5M Track-Type Tractor			3CR1-UP
Engine Oil	1R-0739		
Fuel Primary	117-4089		
Fuel Secondary	1R-0751		
Fuel Secondary	1R-0753		
Hydraulic	1R-0719	132-8875	4T-3131
Power Train	132-8875		
Power Train	132-8876		
Air Primary	6I-2499		
Air Secondary	6I-2500		
D5M Track-Type Tractor			3DR1-UP
Engine Oil	1R-0739		
Fuel Primary	117-4089		
Fuel Secondary	1R-0751		
Fuel Secondary	1R-0753		
Hydraulic	1R-0719	132-8875	4T-3131
Power Train	132-8875		
Power Train	132-8876		
Air Primary	6I-2499		
Air Secondary	6I-2500		
D5M Track-Type Tractor			4BR1-UP
Engine Oil	1R-0739		
Fuel Primary	117-4089		
Fuel Secondary	1R-0751		
Fuel Secondary	1R-0753		
Hydraulic	1R-0719	132-8875	4T-3131
Power Train	132-8875		
Power Train	132-8876		
Air Primary	6I-2499		
Air Secondary	6I-2500		
D5M Track-Type Tractor			6GN1-UP
Engine Oil	1R-0739		
Fuel Primary	117-4089		
Fuel Secondary	1R-0751		
Fuel Secondary	1R-0753		
Hydraulic	1R-0719	132-8875	4T-3131
Power Train	132-8875		
Power Train	132-8876		
Air Primary	6I-2499		
Air Secondary	6I-2500		

FILTER TYPE	PART NUMBER	HIGH EFFICIENCY	FIRE RESISTANT
D5M LGP Track-Type Tractor			3CR1-UP
Engine Oil	1R-0739		
Fuel Primary	117-4089		
Fuel Secondary	1R-0751		
Fuel Secondary	1R-0753		
Hydraulic	1R-0719	132-8875	4T-3131
Power Train	132-8875		
Power Train	132-8876		
Air Primary	6I-2499		
Air Secondary	6I-2500		
D5M LGP Track-Type Tractor			3DR1-UP
Engine Oil	1R-0739		
Fuel Primary	117-4089		
Fuel Secondary	1R-0751		
Fuel Secondary	1R-0753		
Hydraulic	1R-0719	132-8875	4T-3131
Power Train	132-8875		
Power Train	132-8876		
Air Primary	6I-2499		
Air Secondary	6I-2500		
D5M LGP Track-Type Tractor			4BR1-UP
Engine Oil	1R-0739		
Fuel Primary	117-4089		
Fuel Secondary	1R-0751		
Fuel Secondary	1R-0753		
Hydraulic	1R-0719	132-8875	4T-3131
Power Train	132-8875		
Power Train	132-8876		
Air Primary	6I-2499		
Air Secondary	6I-2500		
D5M LGP Track-Type Tractor			4JS1-UP
Engine Oil	1R-0739		
Fuel Primary	117-4089		
Fuel Secondary	1R-0751		
Hydraulic	1R-0719	132-8875	4T-3131
Hydraulic	144-6691	126-1815	121-9868
Power Train	132-8875		
Air Primary	6I-2499		
Air Secondary	6I-2500		
D5M LGP Track-Type Tractor			5ES1-UP
Engine Oil	1R-0739		
Fuel Primary	117-4089		
Fuel Secondary	1R-0751		
Hydraulic	1R-0719	132-8875	4T-3131
Power Train	132-8875		
Power Train	132-8876		
Air Primary	6I-2499		
Air Secondary	6I-2500		

a - For quantities, refer to parts book.

Filters - Track-Type Tractors

FILTER TYPE	PART NUMBER	HIGH EFFICIENCY	FIRE RESISTANT
D5M LGP Track-Type Tractor			5FS1-UP
Engine Oil	1R-0739		
Fuel Primary	117-4089		
Fuel Secondary	1R-0751		
Hydraulic	1R-0719	132-8875	4T-3131
Hydraulic	144-6691	126-1815	121-9868
Power Train	132-8875		
Air Primary	6I-2499		
Air Secondary	6I-2500		
D5M LGP Track-Type Tractor			6AS1-UP
Engine Oil	1R-0739		
Fuel Primary	117-4089		
Fuel Secondary	1R-0751		
Hydraulic	1R-0719	132-8875	4T-3131
Power Train	132-8875		
Power Train	132-8876		
Air Primary	6I-2499		
Air Secondary	6I-2500		
D5M LGP Track-Type Tractor			6GN1-UP
Engine Oil	1R-0739		
Fuel Primary	117-4089		
Fuel Secondary	1R-0751		
Fuel Secondary	1R-0753		
Hydraulic	1R-0719	132-8875	4T-3131
Power Train	132-8875		
Power Train	132-8876		
Air Primary	6I-2499		
Air Secondary	6I-2500		
D5M XL Track-Type Tractor			4JS1-UP
Engine Oil	1R-0739		
Fuel Primary	117-4089		
Fuel Secondary	1R-0751		
Hydraulic	1R-0719	132-8875	4T-3131
Hydraulic	144-6691	126-1815	121-9868
Power Train	132-8875		
Air Primary	6I-2499		
Air Secondary	6I-2500		
D5M XL Track-Type Tractor			5ES1-UP
Engine Oil	1R-0739		
Fuel Primary	117-4089		
Fuel Secondary	1R-0751		
Hydraulic	1R-0719	132-8875	4T-3131
Power Train	132-8875		
Power Train	132-8876		
Air Primary	6I-2499		
Air Secondary	6I-2500		
D5M XL Track-Type Tractor			5FS1-UP
Engine Oil	1R-0739		

FILTER TYPE	PART NUMBER	HIGH EFFICIENCY	FIRE RESISTANT
D5M XL Track-Type Tractor (cont.)			5FS1-UP
Fuel Primary	117-4089		
Fuel Secondary	1R-0751		
Hydraulic	1R-0719	132-8875	4T-3131
Hydraulic	144-6691	126-1815	121-9868
Power Train	132-8875		
Air Primary	6I-2499		
Air Secondary	6I-2500		
D5M XL Track-Type Tractor			6AS1-UP
Engine Oil	1R-0739		
Fuel Primary	117-4089		
Fuel Secondary	1R-0751		
Hydraulic	1R-0719	132-8875	4T-3131
Power Train	132-8875		
Power Train	132-8876		
Air Primary	6I-2499		
Air Secondary	6I-2500		
D6D Track-Type Tractor			5YB800-UP
Fuel Primary	9M-2341		
Fuel Secondary	1R-0750		
Power Train	1R-0741	132-8876	4T-3132
D6D Track-Type Tractor			6HC1-UP
Engine Oil	1R-0739		
Fuel Primary	9M-2341		
Fuel Secondary	1R-0750		
Hydraulic	1R-0728	139-1532	4T-3130
Hydraulic	1R-0746	126-1810	
Power Train	1R-0741	132-8876	4T-3132
Air Primary	7W-5495		
Air Secondary	1P-7360		
D6D Track-Type Tractor			7YK1-UP
Engine Oil	1R-0739		
Fuel Primary	9M-2341		
Fuel Secondary	1R-0750		
Hydraulic	1R-0728	139-1532	4T-3130
Power Train	1R-0741	132-8876	4T-3132
Air Primary	7W-5495		
Air Secondary	1P-7360		
D6D Track-Type Tractor			9FK1-UP
Engine Oil	1R-0739		
Fuel Primary	9M-2341		
Fuel Secondary	1R-0750		
Hydraulic	1R-0728	139-1532	4T-3130
Power Train	1R-0741	132-8876	4T-3132
Air Primary	7W-5495		
Air Secondary	1P-7360		
D6D Track-Type Tractor			19B400-UP
Engine Oil	1R-0739		

a - For quantities, refer to parts book.

Filters - Track-Type Tractors

FILTER TYPE	PART NUMBER	HIGH EFFICIENCY	FIRE RESISTANT
D6D Track-Type Tractor (cont.)			19B400-UP
Fuel Primary	8N-9803		
Fuel Primary	9M-2341		
Fuel Secondary	1R-0750		
Hydraulic	1R-0719	132-8875	4T-3131
Power Train	1R-0741	132-8876	4T-3132
Air Primary	7W-5317		
Air Secondary	2S-1286		
D6D Track-Type Tractor			30X1-UP
Engine Oil	1R-0739		
Fuel Primary	5S-7645		
Fuel Secondary	1R-0750		
Hydraulic	1R-0728	139-1532	4T-3130
Power Train	1R-0741	132-8876	4T-3132
Air Primary	7W-5495		
Air Secondary	1P-7360		
D6D Track-Type Tractor			33X410-UP
Engine Oil	1R-0739		
Fuel Primary	5S-7645		
Fuel Secondary	1R-0750		
Hydraulic	1R-0728	139-1532	4T-3130
Power Train	1R-0741	132-8876	4T-3132
Air Primary	7W-5495		
Air Secondary	1P-7360		
D6D Track-Type Tractor			36C100-UP
Engine Oil	1R-0739		
Fuel Secondary	1R-0750		
Hydraulic	1R-0728	139-1532	4T-3130
Power Train	1R-0741	132-8876	4T-3132
Air Primary	7W-5495		
Air Secondary	1P-7360		
D6D Track-Type Tractor			37C200-UP
Engine Oil	1R-0739		
Fuel Secondary	1R-0750		
Hydraulic	1R-0728	139-1532	4T-3130
Power Train	1R-0741	132-8876	4T-3132
Air Primary	7W-5495		
Air Secondary	1P-7360		
D6D Track-Type Tractor			38C100-UP
Engine Oil	1R-0739		
Fuel Primary	9M-2341		
Fuel Secondary	1R-0750		
Hydraulic	1R-0719	132-8875	4T-3131
Power Train	1R-0741	132-8876	4T-3132
Air Primary	7W-5317		
Air Secondary	2S-1286		
Air Secondary	9S-9972		

FILTER TYPE	PART NUMBER	HIGH EFFICIENCY	FIRE RESISTANT
D6D LGP Track-Type Tractor			33X1-UP
Engine Oil	1R-0739		
Fuel Primary	5S-7645		
Fuel Secondary	1R-0750		
Hydraulic	1R-0728	139-1532	4T-3130
Air Primary	7W-5495		
Air Secondary	1P-7360		
D6D SR Track-Type Tractor			7XF1-UP
Engine Oil	1R-0739		
Fuel Primary	9M-2341		
Fuel Secondary	1R-0750		
Hydraulic	1R-0728	139-1532	4T-3130
Power Train	1R-0741	132-8876	4T-3132
Air Primary	7W-5317		
Air Secondary	2S-1286		
D6E Track-Type Tractor			2MJ1-UP
Engine Oil	1R-0739		
Fuel Primary	9M-2341		
Fuel Secondary	1R-0750		
Hydraulic	1R-0728	139-1532	4T-3130
Power Train	1R-0741	132-8876	4T-3132
Air Primary	7W-5495		
Air Secondary	1P-7360		
D6E Track-Type Tractor			8FJ1-UP
Engine Oil	1R-0739		
Fuel Primary	9M-2341		
Fuel Secondary	1R-0750		
Hydraulic	1R-0728	139-1532	4T-3130
Power Train	1R-0741	132-8876	4T-3132
Air Primary	7W-5317		
Air Secondary	2S-1286		
D6F SR Track-Type Tractor			5FR1-UP
Engine Oil	1R-0739		
Fuel Primary	9M-2341		
Fuel Secondary	1R-0750		
Hydraulic	9T-0973	126-1817	134-3014
Power Train	1R-0741	132-8876	4T-3132
Air Primary	6I-0273		
Air Secondary	6I-0274		
D6G Track-Type Tractor			2MJ2654-UP
Engine Oil	1R-0739		
Fuel Primary	9M-2341		
Fuel Secondary	1R-0750		
Hydraulic	9T-0973	126-1817	134-3014
Power Train	1R-0741	132-8876	4T-3132
Air Primary	6I-0273		
Air Secondary	6I-0274		

a - For quantities, refer to parts book.

Filters - Track-Type Tractors

FILTER TYPE	PART NUMBER	HIGH EFFICIENCY	FIRE RESISTANT
D6G Track-Type Tractor			3SR1-UP
Engine Oil	1R-0739		
Fuel Primary	9M-2341		
Fuel Secondary	1R-0750		
Hydraulic	9T-0973	126-1817	134-3014
Power Train	132-8876		
Power Train	1R-0741	132-8876	4T-3132
Air Primary	6I-0273		
Air Secondary	6I-0274		
D6H Track-Type Tractor			1FJ1-3999
Engine Oil	1R-0739		
Fuel Primary	9M-2341		
Fuel Secondary	1R-0750		
Hydraulic	4T-6788	144-0832	
Hydraulic	9T-8578	144-0832	
Hydraulic	1R-0746	126-1810	
Power Train	1R-0741	132-8876	4T-3132
Air Primary	7W-5317		
Air Secondary	9S-9972		
D6H Track-Type Tractor			1KD1-4073
Engine Oil	1R-0739		
Fuel Primary	9M-2341		
Fuel Secondary	1R-0750		
Hydraulic	1R-0746	126-1810	
Hydraulic	4T-6788	144-0832	
Hydraulic	9T-6636	126-1816	
Power Train	1R-0741	132-8876	4T-3132
Air Primary	7W-5317		
Air Secondary	9S-9972		
D6H Track-Type Tractor			1KD4074-UP
Engine Oil	1R-0739		
Fuel Primary	9M-2341		
Fuel Secondary	1R-0750		
Hydraulic	1R-0735	139-1537	104-6931
Hydraulic	1R-0746	126-1810	
Hydraulic	9T-8578	144-0832	
Power Train	1R-0741	132-8876	4T-3132
Air Primary	7W-5317		
Air Secondary	9S-9972		
D6H Track-Type Tractor			2KD1-4032
Engine Oil	1R-0739		
Fuel Primary	9M-2341		
Fuel Secondary	1R-0750		
Hydraulic	1R-0746	126-1810	
Hydraulic	4T-6788	144-0832	
Hydraulic	9T-6636	126-1816	
Power Train	1R-0741	132-8876	4T-3132
Air Primary	7W-5317		

FILTER TYPE	PART NUMBER	HIGH EFFICIENCY	FIRE RESISTANT
D6H Track-Type Tractor (cont.)			2KD1-4032
Air Secondary	9S-9972		
D6H Track-Type Tractor			2KD4033-UP
Engine Oil	1R-0739		
Fuel Primary	9M-2341		
Fuel Secondary	1R-0750		
Hydraulic	1R-0735	139-1537	104-6931
Hydraulic	1R-0746	126-1810	
Hydraulic	9T-8578	144-0832	
Power Train	1R-0741	132-8876	4T-3132
Air Primary	7W-5317		
Air Secondary	9S-9972		
D6H Track-Type Tractor			2TG1-3999
Engine Oil	1R-0739		
Fuel Primary	9M-2341		
Fuel Secondary	1R-0750		
Hydraulic	1R-0746	126-1810	
Hydraulic	4T-6788	144-0832	
Hydraulic	9T-6636	126-1816	
Hydraulic	9T-8578	144-0832	
Power Train	1R-0741	132-8876	4T-3132
Air Primary	7W-5317		
Air Secondary	9S-9972		
D6H Track-Type Tractor			2TG4000-UP
Engine Oil	1R-0739		
Fuel Primary	9M-2341		
Fuel Secondary	1R-0750		
Hydraulic	1R-0735	139-1537	104-6931
Hydraulic	1R-0746	126-1810	
Hydraulic	9T-8578	144-0832	
Power Train	1R-0741	132-8876	4T-3132
Air Primary	6I-2501		
Air Secondary	6I-2502		
D6H Track-Type Tractor			3ED1-4082
Engine Oil	1R-0739		
Fuel Primary	9M-2341		
Fuel Secondary	1R-0750		
Hydraulic	1R-0746	126-1810	
Hydraulic	4T-6788	144-0832	
Hydraulic	9T-6636	126-1816	
Power Train	1R-0741	132-8876	4T-3132
Air Primary	7W-5317		
Air Secondary	9S-9972		
D6H Track-Type Tractor			3ED4083-UP
Engine Oil	1R-0739		
Fuel Primary	9M-2341		
Fuel Secondary	1R-0750		
Hydraulic	1R-0735	139-1537	104-6931

a - For quantities, refer to parts book.

Filters - Track-Type Tractors

FILTER TYPE	PART NUMBER	HIGH EFFICIENCY	FIRE RESISTANT
D6H Track-Type Tractor (cont.)		3ED4083-UP	
Hydraulic	1R-0746	126-1810	
Hydraulic	9T-8578	144-0832	
Power Train	1R-0741	132-8876	4T-3132
Air Primary	7W-5317		
Air Secondary	9S-9972		
D6H Track-Type Tractor		3YG1-3999	
Engine Oil	1R-0739		
Fuel Primary	9M-2341		
Fuel Secondary	1R-0750		
Hydraulic	1R-0735	139-1537	104-6931
Hydraulic	1R-0746	126-1810	
Hydraulic	4T-6788	144-0832	
Power Train	1R-0741	132-8876	4T-3132
Air Primary	7W-5317		
Air Secondary	9S-9972		
D6H Track-Type Tractor		3YG4000-UP	
Engine Oil	1R-0739		
Fuel Primary	9M-2341		
Fuel Secondary	1R-0750		
Hydraulic	1R-0735	139-1537	104-6931
Hydraulic	1R-0746	126-1810	
Hydraulic	4T-6788	144-0832	
Power Train	1R-0741	132-8876	4T-3132
Air Primary	6I-2501		
Air Secondary	6I-2502		
D6H Track-Type Tractor		3ZF1-3999	
Engine Oil	1R-0739		
Fuel Primary	9M-2341		
Fuel Secondary	1R-0750		
Hydraulic	1R-0735	139-1537	104-6931
Hydraulic	1R-0746	126-1810	
Hydraulic	4T-6788	144-0832	
Power Train	132-8876		
Power Train	1R-0741	132-8876	4T-3132
Air Primary	7W-5317		
Air Secondary	9S-9972		
D6H Track-Type Tractor		3ZF4000-UP	
Engine Oil	1R-0739		
Fuel Primary	9M-2341		
Fuel Secondary	1R-0750		
Hydraulic	1R-0735	139-1537	104-6931
Hydraulic	1R-0746	126-1810	
Hydraulic	4T-6788	144-0832	
Power Train	1R-0741	132-8876	4T-3132
Air Primary	6I-2501		
Air Secondary	6I-2502		

FILTER TYPE	PART NUMBER	HIGH EFFICIENCY	FIRE RESISTANT
D6H Track-Type Tractor		4GG1-UP	
Engine Oil	1R-0739		
Fuel Primary	9M-2341		
Fuel Secondary	1R-0750		
Hydraulic	1R-0735	139-1537	104-6931
Hydraulic	1R-0746	126-1810	
Hydraulic	4T-6788	144-0832	
Power Train	1R-0741	132-8876	4T-3132
Air Primary	7W-5317		
Air Secondary	9S-9972		
D6H Track-Type Tractor		4LG1-3999	
Engine Oil	1R-0739		
Fuel Primary	9M-2341		
Fuel Secondary	1R-0750		
Hydraulic	1R-0746	126-1810	
Hydraulic	4T-6788	144-0832	
Hydraulic	9T-6636	126-1816	
Hydraulic	9T-8578	144-0832	
Power Train	1R-0741	132-8876	4T-3132
Air Primary	7W-5317		
Air Secondary	9S-9972		
D6H Track-Type Tractor		4LG4000-UP	
Engine Oil	1R-0739		
Fuel Primary	9M-2341		
Fuel Secondary	1R-0750		
Hydraulic	1R-0735	139-1537	104-6931
Hydraulic	1R-0746	126-1810	
Hydraulic	9T-8578	144-0832	
Power Train	1R-0741	132-8876	4T-3132
Air Primary	6I-2501		
Air Secondary	6I-2502		
D6H Track-Type Tractor		4RC4000-UP	
Engine Oil	1R-0739		
Fuel Primary	9M-2341		
Fuel Secondary	1R-0750		
Hydraulic	1R-0735	139-1537	104-6931
Hydraulic	1R-0746	126-1810	
Hydraulic	9T-8578	144-0832	
Power Train	1R-0741	132-8876	4T-3132
Air Primary	6I-2501		
Air Secondary	6I-2502		
D6H Track-Type Tractor		4YF1-UP	
Engine Oil	1R-0739		
Fuel Primary	9M-2341		
Fuel Secondary	1R-0750		
Hydraulic	1R-0735	139-1537	104-6931
Hydraulic	1R-0746	126-1810	
Hydraulic	4T-6788	144-0832	

a - For quantities, refer to parts book.

Filters - Track-Type Tractors

FILTER TYPE	PART NUMBER	HIGH EFFICIENCY	FIRE RESISTANT
D6H Track-Type Tractor (cont.)			4YF1-UP
Power Train	1R-0741	132-8876	4T-3132
Air Primary	7W-5317		
Air Secondary	9S-9972		
D6H Track-Type Tractor			5HF1-3999
Engine Oil	1R-0739		
Fuel Primary	9M-2341		
Fuel Secondary	1R-0750		
Hydraulic	1R-0735	139-1537	104-6931
Hydraulic	1R-0746	126-1810	
Hydraulic	4T-6788	144-0832	
Power Train	1R-0741	132-8876	4T-3132
Air Primary	7W-5317		
Air Secondary	9S-9972		
D6H Track-Type Tractor			5HF4000-UP
Engine Oil	1R-0739		
Fuel Primary	9M-2341		
Fuel Secondary	1R-0750		
Hydraulic	1R-0735	139-1537	104-6931
Hydraulic	4T-6788	144-0832	
Hydraulic	1R-0746	126-1810	
Power Train	1R-0741	132-8876	4T-3132
Air Primary	6I-2501		
Air Secondary	6I-2502		
D6H Track-Type Tractor			6CF1-3999
Engine Oil	1R-0739		
Fuel Primary	9M-2341		
Fuel Secondary	1R-0750		
Hydraulic	1R-0735	139-1537	104-6931
Hydraulic	1R-0746	126-1810	
Hydraulic	4T-6788	144-0832	
Power Train	1R-0741	132-8876	4T-3132
Air Primary	7W-5317		
Air Secondary	9S-9972		
D6H Track-Type Tractor			6CF4000-UP
Engine Oil	1R-0739		
Fuel Primary	9M-2341		
Fuel Secondary	1R-0750		
Hydraulic	1R-0735	139-1537	104-6931
Hydraulic	4T-6788	144-0832	
Hydraulic	1R-0746	126-1810	
Power Train	1R-0741	132-8876	4T-3132
Air Primary	6I-2501		
Air Secondary	6I-2502		
D6H Track-Type Tractor			6FC4000-UP
Engine Oil	1R-0739		
Fuel Primary	9M-2341		
Fuel Secondary	1R-0750		

FILTER TYPE	PART NUMBER	HIGH EFFICIENCY	FIRE RESISTANT
D6H Track-Type Tractor (cont.)			6FC4000-UP
Hydraulic	1R-0735	139-1537	104-6931
Hydraulic	1R-0746	126-1810	
Hydraulic	9T-6636	126-1816	
Hydraulic	9T-8578	144-0832	
Power Train	1R-0741	132-8876	4T-3132
Air Primary	6I-2501		
Air Secondary	6I-2502		
D6H Track-Type Tractor			8FC4092-UP
Engine Oil	1R-0739		
Fuel Primary	9M-2341		
Fuel Secondary	1R-0750		
Hydraulic	1R-0735	139-1537	104-6931
Hydraulic	1R-0746	126-1810	
Hydraulic	9T-8578	144-0832	
Power Train	1R-0741	132-8876	4T-3132
Air Primary	7W-5317		
Air Secondary	9S-9972		
D6H Track-Type Tractor			8KB1-UP
Engine Oil	1R-0739		
Fuel Primary	9M-2341		
Fuel Secondary	1R-0750		
Hydraulic	1R-0746	126-1810	
Hydraulic	4T-6788	144-0832	
Hydraulic	9T-6636	126-1816	
Power Train	1R-0741	132-8876	4T-3132
Air Primary	7W-5317		
Air Secondary	9S-9972		
D6H Track-Type Tractor			4RC1-3999
Engine Oil	1R-0739		
Fuel Primary	9M-2341		
Fuel Secondary	1R-0750		
Hydraulic	1R-0735	139-1537	104-6931
Hydraulic	1R-0746	126-1810	
Hydraulic	4T-6788	144-0832	
Hydraulic	9T-6636	126-1816	
Hydraulic	9T-8578	144-0832	
Power Train	1R-0741	132-8876	4T-3132
Air Primary	7W-5317		
Air Secondary	9S-9972		
D6H Track-Type Tractor			6FC1-3999
Engine Oil	1R-0739		
Fuel Primary	9M-2341		
Fuel Secondary	1R-0750		
Hydraulic	1R-0735	139-1537	104-6931
Hydraulic	1R-0746	126-1810	
Hydraulic	4T-6788	144-0832	
Hydraulic	9T-6636	126-1816	

a - For quantities, refer to parts book.

Filters - Track-Type Tractors

FILTER TYPE	PART NUMBER	HIGH EFFICIENCY	FIRE RESISTANT
D6H Track-Type Tractor (cont.)			6FC1-3999
Hydraulic	9T-8578	144-0832	
Power Train	1R-0741	132-8876	4T-3132
Air Primary	7W-5317		
Air Secondary	9S-9972		
D6H Track-Type Tractor			7PC1-UP
Engine Oil	1R-0739		
Fuel Primary	9M-2341		
Fuel Secondary	1R-0750		
Hydraulic	1R-0746	126-1810	
Hydraulic	4T-6788	144-0832	
Hydraulic	9T-6636	126-1816	
Power Train	1R-0741	132-8876	4T-3132
Air Primary	7W-5317		
Air Secondary	9S-9972		
D6H Track-Type Tractor			8FC1-UP
Engine Oil	1R-0739		
Fuel Primary	9M-2341		
Fuel Secondary	1R-0750		
Hydraulic	1R-0746	126-1810	
Hydraulic	4T-6788	144-0832	
Hydraulic	9T-6636	126-1816	
Power Train	1R-0741	132-8876	4T-3132
Air Primary	7W-5317		
Air Secondary	9S-9972		
D6H Track-Type Tractor			8YC1-UP
Engine Oil	1R-0739		
Fuel Primary	9M-2341		
Fuel Secondary	1R-0750		
Hydraulic	1R-0746	126-1810	
Hydraulic	4T-6788	144-0832	
Hydraulic	9T-6636	126-1816	
Power Train	1R-0741	132-8876	4T-3132
Air Primary	7W-5317		
Air Secondary	9S-9972		
D6H Series II Track-Type Tractor			1FJ4000-UP
Engine Oil	1R-0739		
Fuel Primary	9M-2341		
Fuel Secondary	1R-0750		
Hydraulic	1R-0735	139-1537	104-6931
Hydraulic	9T-8578	144-0832	
Hydraulic	1R-0746	126-1810	
Power Train	1R-0741	132-8876	4T-3132
Air Primary	6I-2501		
Air Secondary	6I-2502		
D6H Series II Track-Type Tractor			2DK1-UP
Engine Oil	1R-0739		
Fuel Primary	9M-2341		

FILTER TYPE	PART NUMBER	HIGH EFFICIENCY	FIRE RESISTANT
D6H Series II Track-Type Tractor (cont.)			2DK1-UP
Fuel Secondary	1R-0750		
Hydraulic	1R-0735	139-1537	104-6931
Hydraulic	1R-0746	126-1810	
Hydraulic	4T-6788	144-0832	
Power Train	1R-0741	132-8876	4T-3132
Air Primary	7W-5317		
Air Secondary	9S-9972		
D6H Series II Track-Type Tractor			7ZK1-UP
Engine Oil	1R-0739		
Fuel Primary	9M-2341		
Fuel Secondary	1R-0750		
Hydraulic	1R-0735	139-1537	104-6931
Hydraulic	1R-0746	126-1810	
Hydraulic	9T-8578	144-0832	
Power Train	1R-0741	132-8876	4T-3132
Air Primary	7W-5317		
Air Secondary	9S-9972		
D6H Series II Track-Type Tractor			9RK1-UP
Engine Oil	1R-0739		
Fuel Primary	9M-2341		
Fuel Secondary	1R-0750		
Hydraulic	1R-0735	139-1537	104-6931
Hydraulic	1R-0746	126-1810	
Hydraulic	9T-8578	144-0832	
Power Train	1R-0741	132-8876	4T-3132
Air Primary	7W-5317		
Air Secondary	9S-9972		
D6H LGP Track-Type Tractor			1KD1-UP
Engine Oil	1R-0739		
Fuel Primary	9M-2341		
Fuel Secondary	1R-0750		
Hydraulic	1R-0746	126-1810	
Hydraulic	4T-6788	144-0832	
Hydraulic	9T-6636	126-1816	
Power Train	1R-0741	132-8876	4T-3132
Air Primary	7W-5317		
Air Secondary	9S-9972		
D6H LGP Track-Type Tractor			2KD1-UP
Engine Oil	1R-0739		
Fuel Primary	9M-2341		
Fuel Secondary	1R-0750		
Hydraulic	1R-0746	126-1810	
Hydraulic	4T-6788	144-0832	
Hydraulic	9T-6636	126-1816	
Power Train	1R-0741	132-8876	4T-3132
Air Primary	7W-5317		
Air Secondary	9S-9972		

a - For quantities, refer to parts book.

Filters - Track-Type Tractors

FILTER TYPE	PART NUMBER	HIGH EFFICIENCY	FIRE RESISTANT
D6H LGP Track-Type Tractor			2TG1-3999
Engine Oil	1R-0739		
Fuel Primary	9M-2341		
Fuel Secondary	1R-0750		
Hydraulic	1R-0746	126-1810	
Hydraulic	4T-6788	144-0832	
Hydraulic	9T-6636	126-1816	
Hydraulic	9T-8578	144-0832	
Power Train	1R-0741	132-8876	4T-3132
Air Primary	7W-5317		
Air Secondary	9S-9972		
D6H LGP Track-Type Tractor			3ED1-UP
Engine Oil	1R-0739		
Fuel Primary	9M-2341		
Fuel Secondary	1R-0750		
Hydraulic	1R-0746	126-1810	
Hydraulic	4T-6788	144-0832	
Hydraulic	9T-6636	126-1816	
Power Train	1R-0741	132-8876	4T-3132
Air Primary	7W-5317		
Air Secondary	9S-9972		
D6H LGP Track-Type Tractor			3YG1-3999
Engine Oil	1R-0739		
Fuel Primary	9M-2341		
Fuel Secondary	1R-0750		
Hydraulic	1R-0735	139-1537	104-6931
Hydraulic	1R-0746	126-1810	
Hydraulic	4T-6788	144-0832	
Power Train	1R-0741	132-8876	4T-3132
Air Primary	7W-5317		
Air Secondary	9S-9972		
D6H LGP Track-Type Tractor			3ZF1-3999
Engine Oil	1R-0739		
Fuel Primary	9M-2341		
Fuel Secondary	1R-0750		
Hydraulic	1R-0735	139-1537	104-6931
Hydraulic	1R-0746	126-1810	
Hydraulic	4T-6788	144-0832	
Power Train	132-8876		
Power Train	1R-0741	132-8876	4T-3132
Air Primary	7W-5317		
Air Secondary	9S-9972		
D6H LGP Track-Type Tractor			4LG1-3999
Engine Oil	1R-0739		
Fuel Primary	9M-2341		
Fuel Secondary	1R-0750		
Hydraulic	1R-0746	126-1810	
Hydraulic	4T-6788	144-0832	

FILTER TYPE	PART NUMBER	HIGH EFFICIENCY	FIRE RESISTANT
D6H LGP Track-Type Tractor (cont.)			4LG1-3999
Hydraulic	9T-6636	126-1816	
Hydraulic	9T-8578	144-0832	
Power Train	1R-0741	132-8876	4T-3132
Air Primary	7W-5317		
Air Secondary	9S-9972		
D6H LGP Track-Type Tractor			4RC1-3999
Engine Oil	1R-0739		
Fuel Primary	9M-2341		
Fuel Secondary	1R-0750		
Hydraulic	1R-0735	139-1537	104-6931
Hydraulic	1R-0746	126-1810	
Hydraulic	4T-6788	144-0832	
Hydraulic	9T-6636	126-1816	
Hydraulic	9T-8578	144-0832	
Power Train	1R-0741	132-8876	4T-3132
Air Primary	7W-5317		
Air Secondary	9S-9972		
D6H LGP Track-Type Tractor			6FC1-3999
Engine Oil	1R-0739		
Fuel Primary	9M-2341		
Fuel Secondary	1R-0750		
Hydraulic	1R-0735	139-1537	104-6931
Hydraulic	1R-0746	126-1810	
Hydraulic	4T-6788	144-0832	
Hydraulic	9T-6636	126-1816	
Hydraulic	9T-8578	144-0832	
Power Train	1R-0741	132-8876	4T-3132
Air Primary	7W-5317		
Air Secondary	9S-9972		
D6H LGP Track-Type Tractor			7PC1-UP
Engine Oil	1R-0739		
Fuel Primary	9M-2341		
Fuel Secondary	1R-0750		
Hydraulic	1R-0746	126-1810	
Hydraulic	4T-6788	144-0832	
Hydraulic	9T-6636	126-1816	
Power Train	1R-0741	132-8876	4T-3132
Air Primary	7W-5317		
Air Secondary	9S-9972		
D6H LGP Track-Type Tractor			8FC1-UP
Engine Oil	1R-0739		
Fuel Primary	9M-2341		
Fuel Secondary	1R-0750		
Hydraulic	1R-0746	126-1810	
Hydraulic	4T-6788	144-0832	
Hydraulic	9T-6636	126-1816	
Power Train	1R-0741	132-8876	4T-3132

a - For quantities, refer to parts book.

Filters - Track-Type Tractors

FILTER TYPE	PART NUMBER	HIGH EFFICIENCY	FIRE RESISTANT
D6H LGP Track-Type Tractor (cont.)			8FC1-UP
Air Primary	7W-5317		
Air Secondary	9S-9972		
D6H LGP Track-Type Tractor			8YC1-UP
Engine Oil	1R-0739		
Fuel Primary	9M-2341		
Fuel Secondary	1R-0750		
Hydraulic	1R-0746	126-1810	
Hydraulic	4T-6788	144-0832	
Hydraulic	9T-6636	126-1816	
Power Train	1R-0741	132-8876	4T-3132
Air Primary	7W-5317		
Air Secondary	9S-9972		
D6H LGP Series II Track-Type Tractor			1KD4074-UP
Engine Oil	1R-0739		
Fuel Primary	9M-2341		
Fuel Secondary	1R-0750		
Hydraulic	1R-0735	139-1537	104-6931
Hydraulic	1R-0746	126-1810	
Hydraulic	9T-8578	144-0832	
Power Train	1R-0741	132-8876	4T-3132
Air Primary	7W-5317		
Air Secondary	9S-9972		
D6H LGP Series II Track-Type Tractor			2KD4033-UP
Engine Oil	1R-0739		
Fuel Primary	9M-2341		
Fuel Secondary	1R-0750		
Hydraulic	1R-0735	139-1537	104-6931
Hydraulic	1R-0746	126-1810	
Hydraulic	9T-8578	144-0832	
Power Train	1R-0741	132-8876	4T-3132
Air Primary	7W-5317		
Air Secondary	9S-9972		
D6H LGP Series II Track-Type Tractor			2TG4000-UP
Engine Oil	1R-0739		
Fuel Primary	9M-2341		
Fuel Secondary	1R-0750		
Hydraulic	1R-0735	139-1537	104-6931
Hydraulic	1R-0746	126-1810	
Hydraulic	9T-8578	144-0832	
Power Train	1R-0741	132-8876	4T-3132
Air Primary	6I-2501		
Air Secondary	6I-2502		
D6H LGP Series II Track-Type Tractor			2TL1-UP
Engine Oil	1R-0739		
Fuel Primary	9M-2341		
Fuel Secondary	1R-0750		
Hydraulic	1R-0735	139-1537	104-6931

FILTER TYPE	PART NUMBER	HIGH EFFICIENCY	FIRE RESISTANT
D6H LGP Series II Track-Type Tractor (cont.)			2TL1-UP
Hydraulic	1R-0746	126-1810	
Hydraulic	4T-6788	144-0832	
Power Train	1R-0741	132-8876	4T-3132
Air Primary	7W-5317		
Air Secondary	9S-9972		
D6H LGP Series II Track-Type Tractor			3YG4000-UP
Engine Oil	1R-0739		
Fuel Primary	9M-2341		
Fuel Secondary	1R-0750		
Hydraulic	1R-0735	139-1537	104-6931
Hydraulic	1R-0746	126-1810	
Hydraulic	4T-6788	144-0832	
Power Train	1R-0741	132-8876	4T-3132
Air Primary	6I-2501		
Air Secondary	6I-2502		
D6H LGP Series II Track-Type Tractor			3ZF4000-UP
Engine Oil	1R-0739		
Fuel Primary	9M-2341		
Fuel Secondary	1R-0750		
Hydraulic	1R-0735	139-1537	104-6931
Hydraulic	1R-0746	126-1810	
Hydraulic	4T-6788	144-0832	
Power Train	1R-0741	132-8876	4T-3132
Air Primary	6I-2501		
Air Secondary	6I-2502		
D6H LGP Series II Track-Type Tractor			4GG5500-UP
Engine Oil	1R-0739		
Fuel Primary	9M-2341		
Fuel Secondary	1R-0750		
Hydraulic	1R-0735	139-1537	104-6931
Hydraulic	1R-0746	126-1810	
Hydraulic	4T-6788	144-0832	
Power Train	1R-0741	132-8876	4T-3132
Air Primary	7W-5317		
Air Secondary	9S-9972		
D6H LGP Series II Track-Type Tractor			4LG4000-UP
Engine Oil	1R-0739		
Fuel Primary	9M-2341		
Fuel Secondary	1R-0750		
Hydraulic	1R-0735	139-1537	104-6931
Hydraulic	1R-0746	126-1810	
Hydraulic	9T-8578	144-0832	
Power Train	1R-0741	132-8876	4T-3132
Air Primary	6I-2501		
Air Secondary	6I-2502		
D6H LGP Series II Track-Type Tractor			4RC4000-UP
Engine Oil	1R-0739		

a - For quantities, refer to parts book.

Filters - Track-Type Tractors

FILTER TYPE	PART NUMBER	HIGH EFFICIENCY	FIRE RESISTANT
D6H LGP Series II Track-Type Tractor (cont.)		4RC4000-UP	
Fuel Primary	9M-2341		
Fuel Secondary	1R-0750		
Hydraulic	1R-0735	139-1537	104-6931
Hydraulic	1R-0746	126-1810	
Hydraulic	9T-8578	144-0832	
Power Train	1R-0741	132-8876	4T-3132
Air Primary	6I-2501		
Air Secondary	6I-2502		
D6H LGP Series II Track-Type Tractor		4YF5500-UP	
Engine Oil	1R-0739		
Fuel Primary	9M-2341		
Fuel Secondary	1R-0750		
Hydraulic	1R-0735	139-1537	104-6931
Hydraulic	1R-0746	126-1810	
Hydraulic	4T-6788	144-0832	
Power Train	1R-0741	132-8876	4T-3132
Air Primary	7W-5317		
Air Secondary	9S-9972		
D6H LGP Series II Track-Type Tractor		5HF4000-UP	
Engine Oil	1R-0739		
Fuel Primary	9M-2341		
Fuel Secondary	1R-0750		
Hydraulic	1R-0735	139-1537	104-6931
Hydraulic	4T-6788	144-0832	
Hydraulic	1R-0746	126-1810	
Power Train	1R-0741	132-8876	4T-3132
Air Primary	6I-2501		
Air Secondary	6I-2502		
D6H LGP Series II Track-Type Tractor		6CF4000-UP	
Engine Oil	1R-0739		
Fuel Primary	9M-2341		
Fuel Secondary	1R-0750		
Hydraulic	1R-0735	139-1537	104-6931
Hydraulic	4T-6788	144-0832	
Hydraulic	1R-0746	126-1810	
Power Train	1R-0741	132-8876	4T-3132
Air Primary	6I-2501		
Air Secondary	6I-2502		
D6H LGP Series II Track-Type Tractor		6FC4000-UP	
Engine Oil	1R-0739		
Fuel Primary	9M-2341		
Fuel Secondary	1R-0750		
Hydraulic	1R-0735	139-1537	104-6931
Hydraulic	1R-0746	126-1810	
Hydraulic	9T-6636	126-1816	
Hydraulic	9T-8578	144-0832	
Power Train	1R-0741	132-8876	4T-3132

FILTER TYPE	PART NUMBER	HIGH EFFICIENCY	FIRE RESISTANT
D6H LGP Series II Track-Type Tractor (cont.)		6FC4000-UP	
Air Primary	6I-2501		
Air Secondary	6I-2502		
D6H LS Series II Track-Type Tractor		2DK5500-UP	
Engine Oil	1R-0739		
Fuel Primary	9M-2341		
Fuel Secondary	1R-0750		
Hydraulic	1R-0735	139-1537	104-6931
Hydraulic	1R-0746	126-1810	
Hydraulic	4T-6788	144-0832	
Power Train	1R-0741	132-8876	4T-3132
Air Primary	7W-5317		
Air Secondary	9S-9972		
D6H LGP Series II Track-Type Tractor		8FC5500-UP	
Engine Oil	1R-0739		
Fuel Primary	9M-2341		
Fuel Secondary	1R-0750		
Hydraulic	1R-0735	139-1537	104-6931
Hydraulic	1R-0746	126-1810	
Hydraulic	9T-8578	144-0832	
Power Train	1R-0741	132-8876	4T-3132
Air Primary	7W-5317		
Air Secondary	9S-9972		
D6H LGP Series II Track-Type Tractor		8SK1-UP	
Engine Oil	1R-0739		
Fuel Primary	9M-2341		
Fuel Secondary	1R-0750		
Hydraulic	1R-0735	139-1537	104-6931
Hydraulic	1R-0746	126-1810	
Hydraulic	4T-6788	144-0832	
Power Train	1R-0741	132-8876	4T-3132
Air Primary	7W-5317		
Air Secondary	9S-9972		
D6H XL Track-Type Tractor		9KJ1-UP	
Engine Oil	1R-0739		
Fuel Primary	9M-2341		
Fuel Secondary	1R-0750		
Hydraulic	1R-0735	139-1537	104-6931
Hydraulic	4T-6788	144-0832	
Hydraulic	1R-0746	126-1810	
Power Train	1R-0741	132-8876	4T-3132
Air Primary	6I-2501		
Air Secondary	6I-2502		
D6H XL Series II Track-Type Tractor		8KK1-UP	
Engine Oil	1R-0739		
Fuel Primary	9M-2341		
Fuel Secondary	1R-0750		
Hydraulic	1R-0735	139-1537	104-6931

a - For quantities, refer to parts book.

Filters - Track-Type Tractors

FILTER TYPE	PART NUMBER	HIGH EFFICIENCY	FIRE RESISTANT
D6H XL Series II Track-Type Tractor (cont.)			8KK1-UP
Hydraulic	9T-8578	144-0832	
Hydraulic	1R-0746	126-1810	
Power Train	1R-0741	132-8876	4T-3132
Power Train	4S-8598		
Air Primary	6I-2501		
Air Primary	7W-5317		
Air Secondary	6I-2502		
Air Secondary	9S-9972		
D6H XL Series II Track-Type Tractor			8ZJ1-UP
Engine Oil	1R-0739		
Fuel Primary	9M-2341		
Fuel Secondary	1R-0750		
Hydraulic	1R-0735	139-1537	104-6931
Hydraulic	9T-8578	144-0832	
Hydraulic	1R-0746	126-1810	
Power Train	1R-0741	132-8876	4T-3132
Air Primary	6I-2501		
Air Secondary	6I-2502		
D6H XL Series II Track-Type Tractor			9LK1-UP
Engine Oil	1R-0739		
Fuel Primary	9M-2341		
Fuel Secondary	1R-0750		
Hydraulic	1R-0735	139-1537	104-6931
Hydraulic	4T-6788	144-0832	
Hydraulic	1R-0746	126-1810	
Power Train	1R-0741	132-8876	4T-3132
Air Primary	6I-2501		
Air Secondary	6I-2502		
D6H XR Series II Track-Type Tractor			1YL1-UP
Engine Oil	1R-0739		
Fuel Primary	9M-2341		
Fuel Secondary	1R-0750		
Hydraulic	1R-0735	139-1537	104-6931
Hydraulic	4T-6788	144-0832	
Hydraulic	1R-0746	126-1810	
Power Train	1R-0741	132-8876	4T-3132
Air Primary	6I-2501		
Air Secondary	6I-2502		
D6H XR Series II Track-Type Tractor			2BL1-UP
Engine Oil	1R-0739		
Fuel Primary	9M-2341		
Fuel Secondary	1R-0750		
Hydraulic	1R-0735	139-1537	104-6931
Hydraulic	9T-8578	144-0832	
Hydraulic	1R-0746	126-1810	
Power Train	1R-0741	132-8876	4T-3132
Power Train	4S-8598		

FILTER TYPE	PART NUMBER	HIGH EFFICIENCY	FIRE RESISTANT
D6H XR Series II Track-Type Tractor (cont.)			2BL1-UP
Air Primary	7W-5317		
Air Secondary	9S-9972		
D6H XR Series II Track-Type Tractor			5KK1-UP
Engine Oil	1R-0739		
Fuel Primary	9M-2341		
Fuel Secondary	1R-0750		
Hydraulic	1R-0735	139-1537	104-6931
Hydraulic	9T-8578	144-0832	
Hydraulic	1R-0746	126-1810	
Power Train	1R-0741	132-8876	4T-3132
Power Train	4S-8598		
Air Primary	6I-2501		
Air Secondary	6I-2502		
D6H XR Series II Track-Type Tractor			6CK1-UP
Engine Oil	1R-0739		
Fuel Primary	9M-2341		
Fuel Secondary	1R-0750		
Hydraulic	1R-0735	139-1537	104-6931
Hydraulic	4T-6788	144-0832	
Hydraulic	1R-0746	126-1810	
Power Train	1R-0741	132-8876	4T-3132
Power Train	4S-8598		
Air Primary	6I-2501		
Air Secondary	6I-2502		
D6M Track-Type Tractor			5WR1-UP
Engine Oil	1R-0739		
Fuel Primary	117-4089		
Fuel Secondary	1R-0751		
Hydraulic	1R-0735	139-1537	104-6931
Hydraulic	4T-6915		
Power Train	132-8875		
Air Primary	6I-2501		
Air Secondary	6I-2502		
D6M LGP Track-Type Tractor			2YS1-UP
Engine Oil	1R-0739		
Fuel Primary	117-4089		
Fuel Secondary	1R-0751		
Hydraulic	1R-0735	139-1537	104-6931
Hydraulic	4T-6915		
Hydraulic	144-6691	126-1815	121-9868
Power Train	132-8875		
Air Primary	6I-2501		
Air Secondary	6I-2502		
D6M LGP Track-Type Tractor			4GS1-UP
Engine Oil	1R-0739		
Fuel Primary	117-4089		
Fuel Secondary	1R-0751		

a - For quantities, refer to parts book.

Filters - Track-Type Tractors

FILTER TYPE	PART NUMBER	HIGH EFFICIENCY	FIRE RESISTANT
D6M LGP Track-Type Tractor (cont.)			4GS1-UP
Hydraulic	1R-0735	139-1537	104-6931
Hydraulic	4T-6915		
Hydraulic	144-6691	126-1815	121-9868
Power Train	132-8875		
Air Primary	6I-2501		
Air Secondary	6I-2502		
D6M LGP Track-Type Tractor			4HS1-UP
Engine Oil	1R-0739		
Fuel Primary	117-4089		
Fuel Secondary	1R-0751		
Hydraulic	1R-0735	139-1537	104-6931
Hydraulic	4T-6915		
Hydraulic	144-6691	126-1815	121-9868
Power Train	132-8875		
Air Primary	6I-2501		
Air Secondary	6I-2502		
D6M LGP Track-Type Tractor			5NR1-UP
Engine Oil	1R-0739		
Fuel Primary	117-4089		
Fuel Secondary	1R-0751		
Hydraulic	1R-0735	139-1537	104-6931
Hydraulic	4T-6915		
Hydraulic	144-6691	126-1815	121-9868
Power Train	132-8875		
Air Primary	6I-2501		
Air Secondary	6I-2502		
Power Train	132-8876		
Air Primary	6I-2501		
Air Secondary	6I-2502		
D6M LGP Track-Type Tractor			9ZM1-UP
Engine Oil	1R-0739		
Fuel Primary	117-4089		
Fuel Secondary	1R-0751		
Fuel Secondary	1R-0753		
Hydraulic	1R-0735	139-1537	104-6931
Hydraulic	4T-6915		
Power Train	132-8875		
Power Train	132-8876		
Air Primary	6I-2501		
Air Secondary	6I-2502		
D6M XL Track-Type Tractor			2YS1-UP
Engine Oil	1R-0739		
Fuel Primary	117-4089		
Fuel Secondary	1R-0751		
Hydraulic	1R-0735	139-1537	104-6931
Hydraulic	4T-6915		
Hydraulic	144-6691	126-1815	121-9868

FILTER TYPE	PART NUMBER	HIGH EFFICIENCY	FIRE RESISTANT
D6M XL Track-Type Tractor (cont.)			2YS1-UP
Power Train	132-8875		
Air Primary	6I-2501		
Air Secondary	6I-2502		
D6M XL Track-Type Tractor			4GS1-UP
Engine Oil	1R-0739		
Fuel Primary	117-4089		
Fuel Secondary	1R-0751		
Hydraulic	1R-0735	139-1537	104-6931
Hydraulic	4T-6915		
Hydraulic	144-6691	126-1815	121-9868
Power Train	132-8875		
Air Primary	6I-2501		
Air Secondary	6I-2502		
D6M XL Track-Type Tractor			4HS1-UP
Engine Oil	1R-0739		
Fuel Primary	117-4089		
Fuel Secondary	1R-0751		
Hydraulic	1R-0735	139-1537	104-6931
Hydraulic	4T-6915		
Hydraulic	144-6691	126-1815	121-9868
Power Train	132-8875		
Air Primary	6I-2501		
Air Secondary	6I-2502		
D6M XL Track-Type Tractor			5NR1-UP
Engine Oil	1R-0739		
Fuel Primary	117-4089		
Fuel Secondary	1R-0751		
Hydraulic	1R-0735	139-1537	104-6931
Hydraulic	4T-6915		
Hydraulic	144-6691	126-1815	121-9868
Power Train	132-8875		
Air Primary	6I-2501		
Air Secondary	6I-2502		
D6R Track-Type Tractor			1RW1-UP
Engine Oil	1R-0739		
Fuel Primary	9M-2341		
Fuel Secondary	1R-0750		
Hydraulic	1R-0735	139-1537	104-6931
Hydraulic	4T-6788	144-0832	
Power Train	132-8876		
Air Primary	6I-2501		
Air Secondary	6I-2502		
D6R Track-Type Tractor			2HM1-UP
Engine Oil	1R-0739		
Fuel Primary	9M-2341		
Fuel Secondary	1R-0750		
Hydraulic	1R-0735	139-1537	104-6931

a - For quantities, refer to parts book.

Filters - Track-Type Tractors

FILTER TYPE	PART NUMBER	HIGH EFFICIENCY	FIRE RESISTANT
D6R Track-Type Tractor (cont.)			2HM1-UP
Hydraulic	4T-6788	144-0832	
Power Train	132-8876		
Air Primary	6I-2501		
Air Secondary	6I-2502		
D6R Track-Type Tractor			2YN1-UP
Engine Oil	1R-0739		
Fuel Primary	9M-2341		
Fuel Secondary	1R-0750		
Hydraulic	1R-0735	139-1537	104-6931
Hydraulic	4T-6788	144-0832	
Power Train	132-8876		
Air Primary	6I-2501		
Air Secondary	6I-2502		
D6R Track-Type Tractor			3ZN1-UP
Engine Oil	1R-0739		
Fuel Primary	9M-2341		
Fuel Secondary	1R-0750		
Hydraulic	1R-0735	139-1537	104-6931
Hydraulic	4T-6788	144-0832	
Power Train	132-8876		
Air Primary	6I-2501		
Air Secondary	6I-2502		
D6R Track-Type Tractor			4FM1-UP
Engine Oil	1R-0739		
Fuel Primary	9M-2341		
Fuel Secondary	1R-0750		
Hydraulic	1R-0735	139-1537	104-6931
Hydraulic	4T-6788	144-0832	
Power Train	132-8876		
Air Primary	6I-2501		
Air Secondary	6I-2502		
D6R Track-Type Tractor			4JR1-UP
Engine Oil	1R-0739		
Fuel Primary	9M-2341		
Fuel Secondary	1R-0750		
Hydraulic	1R-0735	139-1537	104-6931
Hydraulic	4T-6788	144-0832	
Power Train	132-8876		
Air Primary	6I-2501		
Air Secondary	6I-2502		
D6R Track-Type Tractor			4TR1-UP
Engine Oil	1R-0739		
Fuel Primary	9M-2341		
Fuel Secondary	1R-0750		
Hydraulic	1R-0735	139-1537	104-6931
Hydraulic	4T-6788	144-0832	
Power Train	132-8876		

FILTER TYPE	PART NUMBER	HIGH EFFICIENCY	FIRE RESISTANT
D6R Track-Type Tractor (cont.)			4TR1-UP
Air Primary	6I-2501		
Air Secondary	6I-2502		
D6R Track-Type Tractor			4WR1-UP
Engine Oil	1R-0739		
Fuel Primary	9M-2341		
Fuel Secondary	1R-0750		
Hydraulic	1R-0735	139-1537	104-6931
Hydraulic	4T-6788	144-0832	
Power Train	132-8876		
Air Primary	6I-2501		
Air Secondary	6I-2502		
D6R Track-Type Tractor			5LN1-UP
Engine Oil	1R-0739		
Fuel Primary	9M-2341		
Fuel Secondary	1R-0750		
Hydraulic	1R-0735	139-1537	104-6931
Hydraulic	4T-6788	144-0832	
Power Train	132-8876		
Air Primary	6I-2501		
Air Secondary	6I-2502		
D6R Track-Type Tractor			5PR1-UP
Engine Oil	1R-0739		
Fuel Primary	9M-2341		
Fuel Secondary	1R-0750		
Hydraulic	1R-0735	139-1537	104-6931
Hydraulic	4T-6788	144-0832	
Power Train	132-8876		
Air Primary	6I-2501		
Air Secondary	6I-2502		
D6R Track-Type Tractor			6FR1-UP
Engine Oil	1R-0739		
Fuel Primary	9M-2341		
Fuel Secondary	1R-0750		
Hydraulic	1R-0735	139-1537	104-6931
Hydraulic	4T-6788	144-0832	
Power Train	132-8876		
Air Primary	6I-2501		
Air Secondary	6I-2502		
D6R Track-Type Tractor			6MR1-UP
Engine Oil	1R-0739		
Fuel Primary	9M-2341		
Fuel Secondary	1R-0750		
Hydraulic	1R-0735	139-1537	104-6931
Hydraulic	4T-6788	144-0832	
Power Train	132-8876		
Air Primary	6I-2501		
Air Secondary	6I-2502		

a - For quantities, refer to parts book.

Filters - Track-Type Tractors

FILTER TYPE	PART NUMBER	HIGH EFFICIENCY	FIRE RESISTANT
D6R Track-Type Tractor			7DR1-UP
Engine Oil	1R-0739		
Fuel Primary	9M-2341		
Fuel Secondary	1R-0750		
Hydraulic	1R-0735	139-1537	104-6931
Hydraulic	4T-6788	144-0832	
Power Train	132-8876		
Air Primary	6I-2501		
Air Secondary	6I-2502		
D6R Track-Type Tractor			7GR1-UP
Engine Oil	1R-0739		
Fuel Primary	9M-2341		
Fuel Secondary	1R-0750		
Hydraulic	1R-0735	139-1537	104-6931
Hydraulic	4T-6788	144-0832	
Power Train	132-8876		
Air Primary	6I-2501		
Air Secondary	6I-2502		
D6R Track-Type Tractor			7KN1-UP
Engine Oil	1R-0739		
Fuel Primary	9M-2341		
Fuel Secondary	1R-0750		
Hydraulic	1R-0735	139-1537	104-6931
Hydraulic	4T-6788	144-0832	
Power Train	132-8876		
Air Primary	6I-2501		
Air Secondary	6I-2502		
D6R Track-Type Tractor			8LN1-UP
Engine Oil	1R-0739		
Fuel Primary	9M-2341		
Fuel Secondary	1R-0750		
Hydraulic	1R-0735	139-1537	104-6931
Hydraulic	4T-6788	144-0832	
Power Train	132-8876		
Air Primary	6I-2501		
Air Secondary	6I-2502		
D6R Track-Type Tractor			9BM1-UP
Engine Oil	1R-0739		
Fuel Primary	9M-2341		
Fuel Secondary	1R-0750		
Hydraulic	1R-0735	139-1537	104-6931
Hydraulic	4T-6788	144-0832	
Power Train	132-8876		
Air Primary	6I-2501		
Air Secondary	6I-2502		
D6R Track-Type Tractor			9MN1-UP
Engine Oil	1R-0739		
Fuel Primary	9M-2341		

FILTER TYPE	PART NUMBER	HIGH EFFICIENCY	FIRE RESISTANT
D6R Track-Type Tractor (cont.)			9MN1-UP
Fuel Secondary	1R-0750		
Hydraulic	1R-0735	139-1537	104-6931
Hydraulic	4T-6788	144-0832	
Power Train	132-8876		
Air Primary	6I-2501		
Air Secondary	6I-2502		
D6R Track-Type Tractor			9PN1-UP
Engine Oil	1R-0739		
Fuel Primary	9M-2341		
Fuel Secondary	1R-0750		
Hydraulic	1R-0735	139-1537	104-6931
Hydraulic	4T-6788	144-0832	
Power Train	132-8876		
Air Primary	6I-2501		
Air Secondary	6I-2502		
D6R Track-Type Tractor			9ZS1-UP
Engine Oil	1R-0739		
Fuel Primary	9M-2341		
Fuel Secondary	1R-0750		
Hydraulic	1R-0735	139-1537	104-6931
Hydraulic	4T-6788	144-0832	
Power Train	132-8876		
Air Primary	6I-2501		
Air Secondary	6I-2502		
D6R LGP Track-Type Tractor			4HN1-UP
Engine Oil	1R-0739		
Fuel Primary	9M-2341		
Fuel Secondary	1R-0750		
Hydraulic	1R-0735	139-1537	104-6931
Hydraulic	4T-6788	144-0832	
Power Train	132-8876		
Air Primary	6I-2501		
Air Secondary	6I-2502		
D6R LGP Track-Type Tractor			6HR1-UP
Engine Oil	1R-0739		
Fuel Primary	9M-2341		
Fuel Secondary	1R-0750		
Hydraulic	1R-0735	139-1537	104-6931
Hydraulic	4T-6788	144-0832	
Power Train	132-8876		
Air Primary	6I-2501		
Air Secondary	6I-2502		
D6R LGP Track-Type Tractor			7AR1-UP
Engine Oil	1R-0739		
Fuel Primary	9M-2341		
Fuel Secondary	1R-0750		
Hydraulic	1R-0735	139-1537	104-6931

a - For quantities, refer to parts book.

Filters - Track-Type Tractors

FILTER TYPE	PART NUMBER	HIGH EFFICIENCY	FIRE RESISTANT
D6R LGP Track-Type Tractor (cont.)			7AR1-UP
Hydraulic	4T-6788	144-0832	
Power Train	132-8876		
Air Primary	6I-2501		
Air Secondary	6I-2502		
D6R LGP Track-Type Tractor			8TM1-UP
Engine Oil	1R-0739		
Fuel Primary	9M-2341		
Fuel Secondary	1R-0750		
Hydraulic	1R-0735	139-1537	104-6931
Hydraulic	4T-6788	144-0832	
Power Train	132-8876		
Air Primary	6I-2501		
Air Secondary	6I-2502		
D6R XL Track-Type Tractor			4MN1-UP
Engine Oil	1R-0739		
Fuel Primary	9M-2341		
Fuel Secondary	1R-0750		
Hydraulic	1R-0735	139-1537	104-6931
Hydraulic	4T-6788	144-0832	
Power Train	132-8876		
Air Primary	6I-2501		
Air Secondary	6I-2502		
D6R XL Track-Type Tractor			4WR1-UP
Engine Oil	1R-0739		
Fuel Primary	9M-2341		
Fuel Secondary	1R-0750		
Hydraulic	1R-0735	139-1537	104-6931
Hydraulic	4T-6788	144-0832	
Power Train	132-8876		
Air Primary	6I-2501		
Air Secondary	6I-2502		
D6R XL Track-Type Tractor			6FR1-UP
Engine Oil	1R-0739		
Fuel Primary	9M-2341		
Fuel Secondary	1R-0750		
Hydraulic	1R-0735	139-1537	104-6931
Hydraulic	4T-6788	144-0832	
Power Train	132-8876		
Air Primary	6I-2501		
Air Secondary	6I-2502		
D6R XR Track-Type Tractor			6HR1-UP
Engine Oil	1R-0739		
Fuel Primary	9M-2341		
Fuel Secondary	1R-0750		
Hydraulic	1R-0735	139-1537	104-6931
Hydraulic	4T-6788	144-0832	
Power Train	132-8876		

FILTER TYPE	PART NUMBER	HIGH EFFICIENCY	FIRE RESISTANT
D6R XR Track-Type Tractor (cont.)			6HR1-UP
Air Primary	6I-2501		
Air Secondary	6I-2502		
D6R XR Track-Type Tractor			7AR1-UP
Engine Oil	1R-0739		
Fuel Primary	9M-2341		
Fuel Secondary	1R-0750		
Hydraulic	1R-0735	139-1537	104-6931
Hydraulic	4T-6788	144-0832	
Power Train	132-8876		
Air Primary	6I-2501		
Air Secondary	6I-2502		
D6R XR Track-Type Tractor			6JN1-UP
Engine Oil	1R-0739		
Fuel Primary	9M-2341		
Fuel Secondary	1R-0750		
Hydraulic	1R-0735	139-1537	104-6931
Hydraulic	4T-6788	144-0832	
Power Train	132-8876		
Air Primary	6I-2501		
Air Secondary	6I-2502		
D6R XR Track-Type Tractor			8XN1-UP
Engine Oil	1R-0739		
Fuel Primary	9M-2341		
Fuel Secondary	1R-0750		
Hydraulic	1R-0735	139-1537	104-6931
Hydraulic	4T-6788	144-0832	
Power Train	132-8876		
Air Primary	6I-2501		
Air Secondary	6I-2502		
D6R XW Track-Type Tractor			DMP1-UP
Engine Oil	1R-0739		
Fuel Secondary	1R-0750		
Hydraulic	1R-0735	139-1537	104-6931
Hydraulic	4T-6788	144-0832	
Power Train	132-8876		
Air Primary	6I-2501		
Air Secondary	6I-2502		
D7G Track-Type Tractor			35N1-UP
Engine Oil	1R-0739		
Fuel Primary	8N-9803		
Fuel Secondary	1R-0750		
Hydraulic	1R-0722	139-1536	4T-3134
Power Train	1R-0741	132-8876	4T-3132
Air Primary	7W-5317		
Air Secondary	2S-1286		
D7G Track-Type Tractor			3GF1-UP
Engine Oil	1R-0739		

a - For quantities, refer to parts book.

Filters - Track-Type Tractors

FILTER TYPE	PART NUMBER	HIGH EFFICIENCY	FIRE RESISTANT
D7G Track-Type Tractor (cont.)			3GF1-UP
Fuel Primary	9M-2341		
Fuel Secondary	1R-0750		
Hydraulic	1R-0722	139-1536	4T-3134
Hydraulic	1R-0746	126-1810	
Power Train	1R-0741	132-8876	4T-3132
Air Primary	7W-5317		
Air Secondary	9S-9972		
D7G Track-Type Tractor			3ZD1-UP
Engine Oil	1R-0739		
Fuel Primary	9M-2341		
Fuel Secondary	1R-0750		
Hydraulic	1R-0722	139-1536	4T-3134
Hydraulic	1R-0746	126-1810	
Power Train	1R-0741	132-8876	4T-3132
Air Primary	7W-5317		
Air Secondary	9S-9972		
D7G Track-Type Tractor			44W441-UP
Engine Oil	1R-0739		
Fuel Primary	9M-2341		
Fuel Secondary	1R-0750		
Hydraulic	1R-0722	139-1536	4T-3134
Power Train	1R-0741	132-8876	4T-3132
Air Primary	7W-5317		
Air Secondary	9S-9972		
D7G Track-Type Tractor			45W407-UP
Engine Oil	1R-0739		
Fuel Primary	9M-2341		
Fuel Secondary	1R-0750		
Hydraulic	1R-0722	139-1536	4T-3134
Air Primary	7W-5317		
Air Secondary	9S-9972		
D7G LGP Track-Type Tractor			44W1-547
Engine Oil	1R-0739		
Fuel Primary	8N-9803		
Fuel Secondary	1R-0750		
Power Train	1R-0741	132-8876	4T-3132
Air Primary	7W-5317		
Air Secondary	9S-9972		
D7G LGP Track-Type Tractor			44W548-UP
Engine Oil	1R-0739		
Fuel Primary	9M-2341		
Fuel Secondary	1R-0750		
Hydraulic	1R-0722	139-1536	4T-3134
Power Train	1R-0741	132-8876	4T-3132
Air Primary	7W-5317		
Air Secondary	9S-9972		

FILTER TYPE	PART NUMBER	HIGH EFFICIENCY	FIRE RESISTANT
D7G LGP Track-Type Tractor			45W1-UP
Engine Oil	1R-0739		
Fuel Primary	8N-9803		
Fuel Secondary	1R-0750		
Power Train	1R-0741	132-8876	4T-3132
Air Primary	7W-5317		
Air Secondary	9S-9972		
D7H Track-Type Tractor			2RG1-UP
Engine Oil	1R-0739		
Fuel Primary	9M-2341		
Fuel Secondary	1R-0750		
Hydraulic	1R-0741	132-8876	4T-3132
Hydraulic	4T-6788	144-0832	
Hydraulic	1R-0746	126-1810	
Power Train	1R-0741	132-8876	4T-3132
Air Primary	7W-5317		
Air Secondary	9S-9972		
D7H Track-Type Tractor			2SB1-UP
Engine Oil	1R-0739		
Fuel Primary	9M-2341		
Fuel Secondary	1R-0750		
Hydraulic	1R-0735	139-1537	104-6931
Hydraulic	1R-0746	126-1810	
Power Train	1R-0741	132-8876	4T-3132
Air Primary	7W-5317		
Air Secondary	9S-9972		
D7H Track-Type Tractor			3XG1-UP
Engine Oil	1R-0739		
Fuel Primary	9M-2341		
Fuel Secondary	1R-0750		
Hydraulic	1R-0741	132-8876	4T-3132
Hydraulic	4T-6788	144-0832	
Hydraulic	1R-0746	126-1810	
Power Train	1R-0741	132-8876	4T-3132
Air Primary	7W-5317		
Air Secondary	9S-9972		
D7H Track-Type Tractor			4AB1-UP
Engine Oil	1R-0739		
Fuel Primary	9M-2341		
Fuel Secondary	1R-0750		
Hydraulic	1R-0735	139-1537	104-6931
Hydraulic	1R-0746	126-1810	
Power Train	1R-0741	132-8876	4T-3132
Air Primary	7W-5317		
Air Secondary	9S-9972		
D7H Track-Type Tractor			4FG1-3999
Engine Oil	1R-0739		
Fuel Primary	9M-2341		

a - For quantities, refer to parts book.

Filters - Track-Type Tractors

FILTER TYPE	PART NUMBER	HIGH EFFICIENCY	FIRE RESISTANT
D7H Track-Type Tractor (cont.)		4FG1-3999	
Fuel Secondary	1R-0750		
Hydraulic	1R-0741	132-8876	4T-3132
Hydraulic	4T-6788	144-0832	
Hydraulic	1R-0746	126-1810	
Power Train	1R-0741	132-8876	4T-3132
Air Primary	7W-5317		
Air Secondary	9S-9972		
D7H Track-Type Tractor		4FG4000-UP	
Engine Oil	1R-0739		
Fuel Primary	9M-2341		
Fuel Secondary	1R-0750		
Hydraulic	1R-0741	132-8876	4T-3132
Hydraulic	4T-6788	144-0832	
Hydraulic	1R-0746	126-1810	
Power Train	132-8876		
Power Train	1R-0741	132-8876	4T-3132
Air Primary	6I-0273		
Air Primary	6I-2501		
Air Secondary	6I-0274		
Air Secondary	6I-2502		
D7H Track-Type Tractor		5BF1-3999	
Engine Oil	1R-0739		
Fuel Primary	9M-2341		
Fuel Secondary	1R-0750		
Hydraulic	1R-0741	132-8876	4T-3132
Hydraulic	4T-6788	144-0832	
Hydraulic	1R-0746	126-1810	
Power Train	1R-0741	132-8876	4T-3132
Air Primary	7W-5317		
Air Secondary	9S-9972		
D7H Track-Type Tractor		5BF4000-UP	
Engine Oil	1R-0739		
Fuel Primary	9M-2341		
Fuel Secondary	1R-0750		
Hydraulic	1R-0741	132-8876	4T-3132
Hydraulic	4T-6788	144-0832	
Hydraulic	1R-0746	126-1810	
Power Train	1R-0741	132-8876	4T-3132
Air Primary	6I-0273		
Air Primary	6I-2501		
Air Secondary	6I-0274		
Air Secondary	6I-2502		
D7H Track-Type Tractor		5WB1-UP	
Engine Oil	1R-0739		
Fuel Primary	9M-2341		
Fuel Secondary	1R-0750		
Hydraulic	1R-0735	139-1537	104-6931

FILTER TYPE	PART NUMBER	HIGH EFFICIENCY	FIRE RESISTANT
D7H Track-Type Tractor (cont.)		5WB1-UP	
Hydraulic	1R-0746	126-1810	
Power Train	1R-0741	132-8876	4T-3132
Air Primary	7W-5317		
Air Secondary	9S-9972		
D7H Track-Type Tractor		77Z1-UP	
Engine Oil	1R-0739		
Fuel Primary	9M-2341		
Fuel Secondary	1R-0750		
Hydraulic	1R-0735	139-1537	104-6931
Hydraulic	1R-0746	126-1810	
Power Train	1R-0741	132-8876	4T-3132
Air Primary	7W-5317		
Air Secondary	9S-9972		
D7H Track-Type Tractor		79Z1-3999	
Engine Oil	1R-0739		
Fuel Primary	9M-2341		
Fuel Secondary	1R-0750		
Hydraulic	1R-0722	139-1536	4T-3134
Hydraulic	1R-0735	139-1537	104-6931
Hydraulic	1R-0746	126-1810	
Power Train	1R-0741	132-8876	4T-3132
Air Primary	7W-5317		
Air Secondary	9S-9972		
D7H Track-Type Tractor		79Z4000-UP	
Engine Oil	1R-0739		
Fuel Primary	9M-2341		
Fuel Secondary	1R-0750		
Hydraulic	1R-0722	139-1536	4T-3134
Hydraulic	1R-0746	126-1810	
Power Train	1R-0741	132-8876	4T-3132
Air Primary	6I-0273		
Air Primary	6I-2501		
Air Secondary	6I-0274		
Air Secondary	6I-2502		
D7H Track-Type Tractor		80Z1-3999	
Engine Oil	1R-0739		
Fuel Primary	9M-2341		
Fuel Secondary	1R-0750		
Hydraulic	1R-0722	139-1536	4T-3134
Hydraulic	1R-0735	139-1537	104-6931
Hydraulic	1R-0746	126-1810	
Power Train	1R-0741	132-8876	4T-3132
Air Primary	7W-5317		
Air Secondary	9S-9972		
D7H Track-Type Tractor		80Z4000-UP	
Engine Oil	1R-0739		
Fuel Primary	9M-2341		

a - For quantities, refer to parts book.

Filters - Track-Type Tractors

FILTER TYPE	PART NUMBER	HIGH EFFICIENCY	FIRE RESISTANT
D7H Track-Type Tractor (cont.)		80Z4000-UP	
Fuel Secondary	1R-0750		
Hydraulic	1R-0722	139-1536	4T-3134
Hydraulic	1R-0746	126-1810	
Power Train	1R-0741	132-8876	4T-3132
Air Primary	6I-0273		
Air Primary	6I-2501		
Air Secondary	6I-0274		
Air Secondary	6I-2502		
D7H Track-Type Tractor		82Z4000-UP	
Engine Oil	1R-0739		
Fuel Primary	9M-2341		
Fuel Secondary	1R-0750		
Hydraulic	1R-0735	139-1537	104-6931
Hydraulic	1R-0746	126-1810	
Power Train	1R-0741	132-8876	4T-3132
Air Primary	7W-5317		
Air Secondary	9S-9972		
D7H LGP Track-Type Tractor		2RG1-UP	
Engine Oil	1R-0739		
Fuel Primary	9M-2341		
Fuel Secondary	1R-0750		
Hydraulic	1R-0741	132-8876	4T-3132
Hydraulic	4T-6788	144-0832	
Hydraulic	1R-0746	126-1810	
Power Train	1R-0741	132-8876	4T-3132
Air Primary	7W-5317		
Air Secondary	9S-9972		
D7H LGP Track-Type Tractor		2SB1-UP	
Engine Oil	1R-0739		
Fuel Primary	9M-2341		
Fuel Secondary	1R-0750		
Hydraulic	1R-0735	139-1537	104-6931
Hydraulic	1R-0746	126-1810	
Power Train	1R-0741	132-8876	4T-3132
Air Primary	7W-5317		
Air Secondary	9S-9972		
D7H LGP Track-Type Tractor		3XG1-UP	
Engine Oil	1R-0739		
Fuel Primary	9M-2341		
Fuel Secondary	1R-0750		
Hydraulic	1R-0741	132-8876	4T-3132
Hydraulic	4T-6788	144-0832	
Hydraulic	1R-0746	126-1810	
Power Train	1R-0741	132-8876	4T-3132
Air Primary	7W-5317		
Air Secondary	9S-9972		

FILTER TYPE	PART NUMBER	HIGH EFFICIENCY	FIRE RESISTANT
D7H LGP Track-Type Tractor		4FG1-3999	
Engine Oil	1R-0739		
Fuel Primary	9M-2341		
Fuel Secondary	1R-0750		
Hydraulic	1R-0741	132-8876	4T-3132
Hydraulic	4T-6788	144-0832	
Hydraulic	1R-0746	126-1810	
Power Train	1R-0741	132-8876	4T-3132
Air Primary	7W-5317		
Air Secondary	9S-9972		
D7H LGP Track-Type Tractor		5BF1-3999	
Engine Oil	1R-0739		
Fuel Primary	9M-2341		
Fuel Secondary	1R-0750		
Hydraulic	1R-0741	132-8876	4T-3132
Hydraulic	4T-6788	144-0832	
Hydraulic	1R-0746	126-1810	
Power Train	1R-0741	132-8876	4T-3132
Air Primary	7W-5317		
Air Secondary	9S-9972		
D7H LGP Track-Type Tractor		79Z1-3999	
Engine Oil	1R-0739		
Fuel Primary	9M-2341		
Fuel Secondary	1R-0750		
Hydraulic	1R-0722	139-1536	4T-3134
Hydraulic	1R-0735	139-1537	104-6931
Hydraulic	1R-0746		
Power Train	1R-0741	132-8876	4T-3132
Air Primary	7W-5317		
Air Secondary	9S-9972		
D7H LGP Track-Type Tractor		80Z1-3999	
Engine Oil	1R-0739		
Fuel Primary	9M-2341		
Fuel Secondary	1R-0750		
Hydraulic	1R-0722	139-1536	4T-3134
Hydraulic	1R-0735	139-1537	104-6931
Hydraulic	1R-0746	126-1810 126-1810	
Power Train	1R-0741	132-8876	4T-3132
Air Primary	7W-5317		
Air Secondary	9S-9972		
D7H LGP Track-Type Tractor		82Z1-UP	
Engine Oil	1R-0739		
Fuel Primary	9M-2341		
Fuel Secondary	1R-0750		
Hydraulic	1R-0735	139-1537	104-6931
Hydraulic	1R-0746		
Power Train	1R-0741	132-8876	4T-3132
Air Primary	7W-5317		

a - For quantities, refer to parts book.

Filters - Track-Type Tractors

FILTER TYPE	PART NUMBER	HIGH EFFICIENCY	FIRE RESISTANT
D7H LGP Track-Type Tractor (cont.)		82Z1-UP	
Air Secondary	9S-9972		
D7H LGP Series II Track-Type Tractor		2RG4000-UP	
Engine Oil	1R-0739		
Fuel Primary	9M-2341		
Fuel Secondary	1R-0750		
Hydraulic	1R-0741	132-8876	4T-3132
Hydraulic	4T-6788	144-0832	
Hydraulic	1R-0746	126-1810	
Power Train	1R-0741	132-8876	4T-3132
Air Primary	7W-5317		
Air Secondary	9S-9972		
D7H LGP Series II Track-Type Tractor		2SB4000-UP	
Engine Oil	1R-0739		
Fuel Primary	9M-2341		
Fuel Secondary	1R-0750		
Hydraulic	1R-0735	139-1537	104-6931
Hydraulic	1R-0746	126-1810	
Power Train	1R-0741	132-8876	4T-3132
Air Primary	7W-5317		
Air Secondary	9S-9972		
D7H LGP Series II Track-Type Tractor		3XG4000-UP	
Engine Oil	1R-0739		
Fuel Primary	9M-2341		
Fuel Secondary	1R-0750		
Hydraulic	1R-0741	132-8876	4T-3132
Hydraulic	4T-6788	144-0832	
Hydraulic	1R-0746	126-1810	
Power Train	1R-0741	132-8876	4T-3132
Air Primary	7W-5317		
Air Secondary	9S-9972		
D7H LGP Series II Track-Type Tractor		4AB4000-UP	
Engine Oil	1R-0739		
Fuel Primary	9M-2341		
Fuel Secondary	1R-0750		
Hydraulic	1R-0735	139-1537	104-6931
Hydraulic	1R-0746	126-1810	
Power Train	1R-0741	132-8876	4T-3132
Air Primary	7W-5317		
Air Secondary	9S-9972		
D7H LGP Series II Track-Type Tractor		4FG4000-UP	
Engine Oil	1R-0739		
Fuel Primary	9M-2341		
Fuel Secondary	1R-0750		
Hydraulic	1R-0741	132-8876	4T-3132
Hydraulic	4T-6788	144-0832	
Hydraulic	1R-0746	126-1810	
Power Train	132-8876		

FILTER TYPE	PART NUMBER	HIGH EFFICIENCY	FIRE RESISTANT
D7H LGP Series II Track-Type Tractor (cont.)		4FG4000-UP	
Power Train	1R-0741	132-8876	4T-3132
Air Primary	6I-0273		
Air Primary	6I-2501		
Air Secondary	6I-0274		
Air Secondary	6I-2502		
D7H LGP Series II Track-Type Tractor		5BF4000-UP	
Engine Oil	1R-0739		
Fuel Primary	9M-2341		
Fuel Secondary	1R-0750		
Hydraulic	1R-0741	132-8876	4T-3132
Hydraulic	4T-6788	144-0832	
Hydraulic	1R-0746	126-1810	
Power Train	1R-0741	132-8876	4T-3132
Air Primary	6I-0273		
Air Primary	6I-2501		
Air Secondary	6I-0274		
Air Secondary	6I-2502		
D7H LGP Series II Track-Type Tractor		5WB4000-UP	
Engine Oil	1R-0739		
Fuel Primary	9M-2341		
Fuel Secondary	1R-0750		
Hydraulic	1R-0735	139-1537	104-6931
Hydraulic	1R-0746	126-1810	
Power Train	1R-0741	132-8876	4T-3132
Air Primary	7W-5317		
Air Secondary	9S-9972		
D7H LGP Series II Track-Type Tractor		79Z4000-UP	
Engine Oil	1R-0739		
Fuel Primary	9M-2341		
Fuel Secondary	1R-0750		
Hydraulic	1R-0722	139-1536	4T-3134
Hydraulic	1R-0746	126-1810	
Power Train	1R-0741	132-8876	4T-3132
Air Primary	6I-0273		
Air Primary	6I-2501		
Air Secondary	6I-0274		
Air Secondary	6I-2502		
D7H LGP Series II Track-Type Tractor		80Z4000-UP	
Engine Oil	1R-0739		
Fuel Primary	9M-2341		
Fuel Secondary	1R-0750		
Hydraulic	1R-0722	139-1536	4T-3134
Hydraulic	1R-0746	126-1810	
Power Train	1R-0741	132-8876	4T-3132
Air Primary	6I-0273		
Air Primary	6I-2501		
Air Secondary	6I-0274		

a - For quantities, refer to parts book.

Filters - Track-Type Tractors

FILTER TYPE	PART NUMBER	HIGH EFFICIENCY	FIRE RESISTANT
D7H LGP Series II Track-Type Tractor (cont.)		80Z4000-UP	
Air Secondary	6I-2502		
D7H LGP Series II Track-Type Tractor		82Z4000-UP	
Engine Oil	1R-0739		
Fuel Primary	9M-2341		
Fuel Secondary	1R-0750		
Hydraulic	1R-0735	139-1537	104-6931
Hydraulic	1R-0746	126-1810	
Power Train	1R-0741	132-8876	4T-3132
Air Primary	7W-5317		
Air Secondary	9S-9972		
D7R Track-Type Tractor		2EN1-UP	
Engine Oil	1R-0739		
Fuel Primary	9M-2341		
Fuel Secondary	1R-0750		
Hydraulic	1R-0741	132-8876	4T-3132
Hydraulic	4T-6788	144-0832	
Hydraulic	1R-0746	126-1810	
Power Train	132-8876		
Air Primary	6I-0273		
Air Secondary	6I-0274		
D7R Track-Type Tractor		2HR1-UP	
Engine Oil	1R-0739		
Fuel Primary	9M-2341		
Fuel Secondary	1R-0750		
Hydraulic	1R-0741	132-8876	4T-3132
Hydraulic	1R-0746	126-1810	
Power Train	132-8876		
Air Primary	6I-0273		
Air Secondary	6I-0274		
D7R Track-Type Tractor		3ZR1-UP	
Engine Oil	1R-0739		
Fuel Primary	9M-2341		
Fuel Secondary	1R-0750		
Hydraulic	1R-0741	132-8876	4T-3132
Hydraulic	1R-0746	126-1810	
Power Train	132-8876		
Air Primary	6I-0273		
Air Secondary	6I-0274		
D7R Track-Type Tractor		4SR1-UP	
Engine Oil	1R-0739		
Fuel Primary	9M-2341		
Fuel Secondary	1R-0750		
Hydraulic	1R-0741	132-8876	4T-3132
Hydraulic	1R-0746	126-1810	
Power Train	132-8876		
Air Primary	6I-0273		
Air Secondary	6I-0274		

FILTER TYPE	PART NUMBER	HIGH EFFICIENCY	FIRE RESISTANT
D7R Track-Type Tractor		5KZ1-UP	
Engine Oil	1R-0739		
Fuel Primary	9M-2341		
Fuel Secondary	1R-0750		
Hydraulic	1R-0741	132-8876	4T-3132
Hydraulic	4T-6788	144-0832	
Power Train	132-8876		
Air Primary	6I-0273		
Air Secondary	6I-0274		
D7R Track-Type Tractor		5MR1-UP	
Fuel Primary	9M-2341		
Fuel Secondary	1R-0750		
Hydraulic	1R-0741	132-8876	4T-3132
Hydraulic	4T-6788	144-0832	
Power Train	132-8876		
Air Primary	6I-0273		
Air Secondary	6I-0274		
D7R Track-Type Tractor		9HM1-UP	
Engine Oil	1R-0739		
Fuel Primary	9M-2341		
Fuel Secondary	1R-0750		
Hydraulic	1R-0741	132-8876	4T-3132
Hydraulic	1R-0746	126-1810	
Power Train	132-8876		
Air Primary	6I-0273		
Air Secondary	6I-0274		
D7R LGP Track-Type Tractor		3DN1-UP	
Engine Oil	1R-0739		
Fuel Primary	9M-2341		
Fuel Secondary	1R-0750		
Hydraulic	1R-0741	132-8876	4T-3132
Hydraulic	4T-6788	144-0832	
Hydraulic	1R-0746	126-1810	
Power Train	132-8876		
Air Primary	6I-0273		
Air Secondary	6I-0274		
D8L Track-Type Tractor		4FB1-UP	
Engine Oil	1R-0716		
Fuel Primary	9M-2341		
Fuel Secondary	1R-0749		
Hydraulic	4T-6915		
Hydraulic	1R-0732	139-1535	4T-3133
Power Train	1R-0719	132-8875	4T-3131
Air Primary	7W-5313		
Air Secondary	6N-6444		
D8L Track-Type Tractor		53Y1-UP	
Engine Oil	1R-0716		
Fuel Primary	9M-2341		

a - For quantities, refer to parts book.

Filters - Track-Type Tractors

FILTER TYPE	PART NUMBER	HIGH EFFICIENCY	FIRE RESISTANT
D8L Track-Type Tractor (cont.)			53Y1-UP
Fuel Secondary	1R-0749		
Hydraulic	1R-0732	139-1535	4T-3133
Hydraulic	1R-0746	126-1810	
Power Train	1R-0719	132-8875	4T-3131
Air Primary	7W-5313		
Air Secondary	6N-6444		
D8L Track-Type Tractor			7JC1-UP
Engine Oil	1R-0716		
Fuel Primary	9M-2341		
Fuel Secondary	1R-0749		
Hydraulic	1R-0732	139-1535	4T-3133
Power Train	1R-0719	132-8875	4T-3131
Air Primary	1P-8483		
Air Secondary	6N-6444		
D8L Track-Type Tractor			7YB1-1572
Engine Oil	1R-0716		
Fuel Primary	9M-2341		
Power Train	132-8875		
Air Primary	1P-8483		
Air Secondary	6N-6444		
D8L Track-Type Tractor			7YB1573-UP
Fuel Primary	9M-2341		
Power Train	132-8875		
Power Train	4T-3131		
Air Primary	1P-8483		
Air Secondary	6N-6444		
D8N Track-Type Tractor			1XJ1-UP
Engine Oil	1R-0716		
Fuel Primary	9M-2341		
Fuel Secondary	1R-0749		
Hydraulic	1R-0741	132-8876	4T-3132
Hydraulic	4T-6788	144-0832	
Power Train	1R-0741	132-8876	4T-3132
Air Primary	6I-0273		
Air Primary	7W-5495		
Air Secondary	1P-7360		
Air Secondary	6I-0274		
D8N Track-Type Tractor			5TJ1-UP
Engine Oil	1R-0716		
Fuel Primary	9M-2341		
Fuel Secondary	1R-0749		
Hydraulic	4T-3131		
Air Primary	6I-0273		
Air Primary	7W-5495		
Air Secondary	1P-7360		
D8N Track-Type Tractor			7TK1-UP
Engine Oil	1R-0716		

FILTER TYPE	PART NUMBER	HIGH EFFICIENCY	FIRE RESISTANT
D8N Track-Type Tractor (cont.)			7TK1-UP
Fuel Primary	9M-2341		
Hydraulic	1R-0735	139-1537	104-6931
Power Train	4T-3131		
Air Primary	6I-0273		
Air Secondary	6I-0274		
D8N Track-Type Tractor			9TC1-UP
Engine Oil	1R-0716		
Fuel Primary	9M-2341		
Hydraulic	1R-0741	132-8876	4T-3132
Hydraulic	4T-6788	144-0832	
Hydraulic	1R-0746	126-1810	
Power Train	1R-0741	132-8876	4T-3132
Air Primary	6I-0273		
Air Primary	7W-5495		
Air Secondary	1P-7360		
Air Secondary	6I-0274		
D8R Track-Type Tractor			7XM1-UP
Engine Oil	1R-0716		
Fuel Primary	9M-2341		
Fuel Secondary	1R-0749		
Hydraulic	139-1537		
Hydraulic	1R-0746	126-1810	
Power Train	132-8876		
Power Train	4T-3131		
Power Train	4T-3132		
Air Primary	6I-2505		
Air Secondary	6I-2506		
D8R Track-Type Tractor			9EM1-UP
Engine Oil	1R-0716		
Fuel Primary	9M-2341		
Fuel Secondary	1R-0749		
Hydraulic	104-6931		
Hydraulic	139-1537		
Hydraulic	1R-0735	139-1537	104-6931
Hydraulic	4T-3131		
Power Train	4T-3132		
Air Primary	6I-2505		
Air Secondary	6I-2506		
D8R Track-Type Tractor			AKA1-UP
Engine Oil	1R-0716		
Fuel Primary	1R-0769		
Fuel Secondary	1R-0749		
Hydraulic	1R-0735	139-1537	104-6931
Power Train	132-8876		
Power Train	1R-0778		
Air Primary	6I-2505		
Air Secondary	6I-2506		

a - For quantities, refer to parts book.

Filters - Track-Type Tractors

FILTER TYPE	PART NUMBER	HIGH EFFICIENCY	FIRE RESISTANT
D8R Series II Track-Type Tractor			6YZ1-UP
Engine Oil	1R-0716		
Fuel Primary	1R-0769		
Fuel Secondary	1R-0749		
Hydraulic	104-6931		
Hydraulic	139-1537		
Power Train	102-2828		
Power Train	1R-0778		
Power Train	4T-3132		
Air Primary	6I-2505		
Air Secondary	6I-2506		
D9N Track-Type Tractor			1JD1-UP
Engine Oil	1R-0716		
Fuel Primary	9M-2341		
Power Train	1R-0719	132-8875	4T-3131
Air Primary	7W-5313		
Air Secondary	6N-6444		
D9N Track-Type Tractor			6XJ1-UP
Engine Oil	1R-0716		
Fuel Primary	9M-2341		
Fuel Secondary	1R-0749		
Air Primary	6I-2507		
Air Secondary	6I-2508		
D9R Track-Type Tractor			7TL1-556
Engine Oil	1R-0716		
Fuel Primary	9M-2341		
Fuel Secondary	1R-0749		
Hydraulic	1R-0722	139-1536	4T-3134
Hydraulic	1R-0735	139-1537	104-6931
Power Train	1R-0719	132-8875	4T-3131
Air Primary	6I-2507		
Air Secondary	6I-2508		
D9R Track-Type Tractor			7TL557-851
Engine Oil	1R-0716		
Fuel Primary	129-0373		
Fuel Primary	9M-2341		
Fuel Secondary	1R-0749		
Hydraulic	1R-0722	139-1536	4T-3134
Hydraulic	1R-0735	139-1537	104-6931
Power Train	1R-0719	132-8875	4T-3131
Air Primary	6I-2507		
Air Secondary	6I-2508		
D9R Track-Type Tractor			7TL852-UP
Engine Oil	1R-0716		
Fuel Primary	129-0373		
Fuel Secondary	1R-0749		
Hydraulic	1R-0722	139-1536	4T-3134
Hydraulic	1R-0735	139-1537	104-6931

FILTER TYPE	PART NUMBER	HIGH EFFICIENCY	FIRE RESISTANT
D9R Track-Type Tractor (cont.)			7TL852-UP
Power Train	1R-0719	132-8875	4T-3131
Air Primary	6I-2507		
Air Secondary	6I-2508		
D9R Track-Type Tractor			8BL1-830
Engine Oil	1R-0716		
Fuel Primary	9M-2341		
Fuel Secondary	1R-0749		
Hydraulic	1R-0722	139-1536	4T-3134
Hydraulic	1R-0735	139-1537	104-6931
Hydraulic	1R-0746	126-1810	
Power Train	1R-0719	132-8875	4T-3131
Air Primary	6I-2507		
Air Secondary	6I-2508		
D9R Track-Type Tractor			8BL830-1052
Engine Oil	1R-0716		
Fuel Primary	129-0373		
Fuel Primary	9M-2341		
Fuel Secondary	1R-0749		
Hydraulic	1R-0722	139-1536	4T-3134
Hydraulic	1R-0735	139-1537	104-6931
Hydraulic	1R-0746	126-1810	
Power Train	1R-0719	132-8875	4T-3131
Air Primary	6I-2507		
Air Secondary	6I-2508		
D9R Track-Type Tractor			8BL1053-UP
Engine Oil	1R-0716		
Fuel Primary	129-0373		
Fuel Secondary	1R-0749		
Hydraulic	104-6931		
Hydraulic	1R-0722	139-1536	4T-3134
Hydraulic	1R-0735	139-1537	104-6931
Hydraulic	1R-0746	126-1810	
Power Train	1R-0719	132-8875	4T-3131
Air Primary	6I-2507		
Air Secondary	6I-2508		
D9R Track-Type Tractor			ABK1-UP
Engine Oil	1R-0716		
Fuel Primary	1R-0769		
Fuel Secondary	1R-0749		
Hydraulic	104-6931		
Hydraulic	1R-0722	139-1536	4T-3134
Hydraulic	1R-0735	139-1537	104-6931
Power Train	1R-0719	132-8875	4T-3131
Air Primary	132-7166		
Air Primary	165-1689		
Air Primary	6I-2507		
Air Secondary	6I-2508		

a - For quantities, refer to parts book.

Filters - Track-Type Tractors

FILTER TYPE	PART NUMBER	HIGH EFFICIENCY	FIRE RESISTANT
D9R Track-Type Tractor			ACL1-UP
Engine Oil	1R-0716		
Fuel Primary	1R-0769		
Fuel Secondary	1R-0749		
Hydraulic	1R-0722	139-1536	4T-3134
Hydraulic	1R-0735	139-1537	104-6931
Power Train	1R-0719	132-8875	4T-3131
Air Primary	132-7166		
Air Primary	165-1689		
Air Primary	6I-2507		
Air Secondary	6I-2508		
D10N Track-Type Tractor			2YD1-UP
Engine Oil	1R-0716		
Fuel Primary	9M-2342		
Fuel Secondary	1R-0749		
Hydraulic	1R-0735	139-1537	104-6931
Hydraulic	1R-0732	139-1535	4T-3133
Hydraulic	1R-0746	126-1810	
Power Train	1R-0719	132-8875	4T-3131
Air Primary	7W-9853		
Air Secondary	7W-9567		
D10N Track-Type Tractor			3SK1-UP
Engine Oil	1R-0716		
Fuel Primary	9M-2342		
Fuel Secondary	1R-0749		
Hydraulic	1R-0735	139-1537	104-6931
Hydraulic	1R-0746	126-1810	
Power Train	1R-0719	132-8875	4T-3131
Air Primary	106-3969		
Air Primary	7W-9853		
Air Secondary	106-3973		
Air Secondary	7W-9567		
D10R Track-Type Tractor			3KR1-UP
Engine Oil	1R-0716		
Fuel Primary	129-0373		
Fuel Primary	1R-0769		
Fuel Secondary	1R-0749		
Hydraulic	1R-0735	139-1537	104-6931
Hydraulic	4T-3130		
Hydraulic	1R-0746	126-1810	
Power Train	132-8875		
Power Train	132-8876		
Air Primary	106-3969		
Air Secondary	106-3973		
D11N Track-Type Tractor			4HK1-UP
Engine Oil	2P-4005		
Fuel Primary	9M-2342		
Fuel Secondary	1R-0755		

FILTER TYPE	PART NUMBER	HIGH EFFICIENCY	FIRE RESISTANT
D11N Track-Type Tractor (cont.)			4HK1-UP
Hydraulic	1R-0732	139-1535	4T-3133
Power Train	1R-0741	132-8876	4T-3132
Air Primary	123-6855		
Air Primary	6I-2505		
Air Secondary	123-6856		
Air Secondary	6I-2506		
D11N Track-Type Tractor			74Z1-UP
Engine Oil	2P-4005		
Fuel Primary	9M-2342		
Fuel Secondary	1R-0755		
Hydraulic	1R-0732	139-1535	4T-3133
Power Train	1R-0741	132-8876	4T-3132
Air Primary	6I-2505		
Air Primary	7W-5313		
Air Secondary	1P-8482		
Air Secondary	6I-2506		
D11R Track-Type Tractor			7PZ1-UP
Engine Oil	2P-4005		
Fuel Primary	9M-2342		
Fuel Secondary	1R-0755		
Hydraulic	132-8875		
Hydraulic	134-0964	4C-6860	
Hydraulic	139-1535		
Power Train	132-8876		
Air Primary	123-6855		
Air Secondary	123-6856		
D11R Track-Type Tractor			8ZR1-UP
Engine Oil	2P-4005		
Fuel Primary	9M-2342		
Fuel Secondary	1R-0755		
Hydraulic	1R-0732	139-1535	4T-3133
Power Train	132-8876		
Air Primary	123-6855		
Air Secondary	123-6856		
D11R Track-Type Tractor			9TR1-UP
Engine Oil	2P-4005		
Fuel Primary	9M-2342		
Fuel Secondary	1R-0755		
Hydraulic	1R-0732	139-1535	4T-3133
Power Train	132-8876		
Air Primary	123-6855		
Air Secondary	123-6856		
D11R Track-Type Tractor			9XR1-UP
Engine Oil	2P-4005		
Fuel Primary	9M-2342		
Fuel Secondary	1R-0755		
Hydraulic	132-8875		

a - For quantities, refer to parts book.

Filters - Track-Type Tractors, Wheel Loaders

FILTER TYPE	PART NUMBER	HIGH EFFICIENCY	FIRE RESISTANT
D11R Track-Type Tractor (cont.)			9XR1-UP
Hydraulic	134-0964	4C-6860	
Hydraulic	139-1535		
Power Train	132-8876		
Air Primary	123-6855		
Air Secondary	123-6856		
D11R Track-Type Tractor			AAF1-UP
Engine Oil	2P-4005		
Fuel Primary	9M-2342		
Fuel Secondary	1R-0755		
Hydraulic	132-8875		
Hydraulic	134-0964	4C-6860	
Hydraulic	139-1535		
Power Train	132-8876		
Air Primary	123-6855		
Air Secondary	123-6856		
WHEEL LOADERS ^a			
902 Wheel Loader			7ES1-UP
Engine Oil	150-4140		
Engine Oil	1R-0734		
Fuel Secondary	156-1200		
Power Train	1G-8878	102-2828	156-0214
Air Primary	134-8726		
Air Secondary	140-2334		
906 Wheel Loader			6ZS1-UP
Engine Oil	1R-0734		
Fuel Primary	138-3100		
Fuel Secondary	159-6102		
Power Train	1G-8878	102-2828	156-0214
Air Primary	134-8726		
Air Secondary	140-2334		
908 Wheel Loader			8BS1-UP
Engine Oil	7W-2326		
Fuel Primary	151-2409		
Fuel Secondary	159-6102		
Power Train	1G-8878	102-2828	156-0214
Air Primary	110-6326		
Air Secondary	110-6331		
910E Wheel Loader			1SF1-1103
Engine Oil	1R-0714		
Fuel Primary	9M-2341		
Fuel Secondary	1R-0750		
Hydraulic	1R-0735	139-1537	104-6931
Power Train	9T-9054	9T-7656	
Air Primary	7W-3920		
Air Secondary	7C-1062		
910F Wheel Loader			1SF1104-UP
Engine Oil	1R-0714		

FILTER TYPE	PART NUMBER	HIGH EFFICIENCY	FIRE RESISTANT
910F Wheel Loader (cont.)			1SF1104-UP
Fuel Primary	9M-2341		
Fuel Secondary	1R-0751		
Hydraulic	1R-0735	139-1537	104-6931
Power Train	1G-8878	102-2828	156-0214
Power Train	9T-9054	9T-7656	
Air Primary	4I-7575		
Air Secondary	6I-6582		
910G Wheel Loader			AKR1-UP
Fuel Primary	151-2409		
Power Train	1G-8878	102-2828	156-0214
Air Primary	131-8902		
914G Wheel Loader			7ZM1-UP
Engine Oil	7W-2326		
Fuel Primary	131-1812		
Fuel Secondary	159-6102		
Hydraulic	1G-8878	102-2828	156-0214
Power Train	1G-8878	102-2828	156-0214
Air Primary	110-6326		
Air Primary	4I-7575		
Air Secondary	110-6331		
Air Secondary	122-4550		
914G Wheel Loader			9WM1-UP
Engine Oil	7W-2326		
Fuel Primary	131-1812		
Fuel Secondary	159-6102		
Hydraulic	1G-8878	102-2828	156-0214
Power Train	1G-8878	102-2828	156-0214
Air Primary	110-6326		
Air Primary	4I-7575		
Air Secondary	110-6331		
Air Secondary	122-4550		
916 Wheel Loader			2XB1-UP
Engine Oil	1R-0714		
Fuel Primary	9M-2341		
Fuel Secondary	1R-0750		
Hydraulic	1R-0722	139-1536	4T-3134
Power Train	1R-0746	126-1810	
Air Primary	7W-5389		
Air Secondary	8N-4901		
916 Wheel Loader			5KC1-UP
Engine Oil	1R-0714		
Fuel Primary	9M-2341		
Fuel Secondary	1R-0750		
Hydraulic	1R-0722	139-1536	4T-3134
Power Train	1R-0746	126-1810	
Air Primary	7W-5389		
Air Secondary	8N-4901		

a - For quantities, refer to parts book.

Filters - Wheel Loaders

FILTER TYPE	PART NUMBER	HIGH EFFICIENCY	FIRE RESISTANT
916 Wheel Loader		9WB2005-UP	
Engine Oil	1R-0714		
Fuel Primary	9M-2341		
Fuel Secondary	1R-0750		
Hydraulic	1R-0722	139-1536	4T-3134
Power Train	1R-0746	126-1810	
Air Primary	7W-5389		
Air Secondary	8N-4901		
918F Wheel Loader		2CK1-UP	
Engine Oil	1R-0714		
Fuel Primary	9M-2341		
Fuel Secondary	1R-0750		
Hydraulic	1R-0722	139-1536	4T-3134
Power Train	1G-8878	102-2828	156-0214
Air Primary	6I-2499		
Air Secondary	6I-2500		
918F Wheel Loader		3TJ1-UP	
Engine Oil	1R-0714		
Fuel Primary	9M-2341		
Fuel Secondary	1R-0751		
Hydraulic	1R-0722	139-1536	4T-3134
Power Train	1G-8878	102-2828	156-0214
Air Primary	6I-2499		
Air Secondary	6I-2500		
918F Wheel Loader		5DL1-UP	
Engine Oil	1R-0714		
Fuel Primary	9M-2341		
Fuel Secondary	1R-0750		
Hydraulic	1R-0722	139-1536	4T-3134
Power Train	1G-8878	102-2828	156-0214
Air Primary	6I-2499		
Air Secondary	6I-2500		
924F Wheel Loader		4YN1-UP	
Engine Oil	1R-0714		
Engine Oil	1R-0739		
Engine Oil	1W-8845		
Fuel Primary	117-4089		
Fuel Primary	151-2409		
Fuel Primary	9M-2341		
Fuel Secondary	1R-0751		
Hydraulic	1R-0722	139-1536	4T-3134
Power Train	1G-8878	102-2828	156-0214
Air Primary	6I-2499		
Air Secondary	6I-2500		
924F Wheel Loader		5NN1-UP	
Engine Oil	1R-0714		
Engine Oil	1R-0739		
Engine Oil	1W-8845		

FILTER TYPE	PART NUMBER	HIGH EFFICIENCY	FIRE RESISTANT
924F Wheel Loader (cont.)		5NN1-UP	
Fuel Primary	117-4089		
Fuel Primary	151-2409		
Fuel Primary	9M-2341		
Fuel Secondary	1R-0751		
Hydraulic	1R-0722	139-1536	4T-3134
Power Train	1G-8878	102-2828	156-0214
Air Primary	6I-2499		
Air Secondary	6I-2500		
924F Wheel Loader		6MN1-UP	
Engine Oil	1R-0714		
Fuel Secondary	1R-0751		
Hydraulic	1R-0722	139-1536	4T-3134
Power Train	1G-8878	102-2828	156-0214
Air Primary	6I-2499		
Air Secondary	6I-2500		
924F Wheel Loader		7PN1-UP	
Engine Oil	1R-0714		
Fuel Primary	9M-2341		
Fuel Secondary	1R-0751		
Hydraulic	1R-0722	139-1536	4T-3134
Power Train	1G-8878	102-2828	156-0214
Air Primary	6I-2499		
Air Secondary	6I-2500		
924G Wheel Loader		3DZ1-UP	
Engine Oil	7W-2327		
Fuel Primary	163-4465		
Fuel Secondary	145-4501		
Hydraulic	126-1818		
Power Train	1G-8878	102-2828	156-0214
Air Primary	152-7217		
Air Secondary	152-7219		
924G Wheel Loader		3PZ1-UP	
Engine Oil	7W-2327		
Fuel Primary	163-4465		
Fuel Secondary	145-4501		
Hydraulic	126-1818		
Power Train	1G-8878	102-2828	156-0214
Air Primary	152-7217		
Air Secondary	152-7219		
924G Wheel Loader		6YW1-UP	
Engine Oil	7W-2327		
Fuel Primary	163-4465		
Fuel Secondary	145-4501		
Hydraulic	126-1818		
Power Train	1G-8878	102-2828	156-0214
Air Primary	152-7217		
Air Secondary	152-7219		

a - For quantities, refer to parts book.

Filters - Wheel Loaders

FILTER TYPE	PART NUMBER	HIGH EFFICIENCY	FIRE RESISTANT
924G Wheel Loader		9SW1-UP	
Engine Oil	7W-2327		
Fuel Primary	163-4465		
Fuel Secondary	145-4501		
Hydraulic	126-1818		
Power Train	1G-8878	102-2828	156-0214
Air Primary	152-7217		
Air Secondary	152-7219		
924G Wheel Loader		AAB1-UP	
Engine Oil	7W-2327		
Fuel Primary	163-4465		
Fuel Secondary	145-4501		
Hydraulic	126-1818		
Power Train	1G-8878	102-2828	156-0214
Air Primary	152-7217		
Air Secondary	152-7219		
924G Wheel Loader		AAN1-UP	
Engine Oil	7W-2327		
Fuel Primary	163-4465		
Fuel Secondary	145-4501		
Hydraulic	126-1818		
Power Train	1G-8878	102-2828	156-0214
Air Primary	152-7217		
Air Secondary	152-7219		
924GZ Wheel Loader		3DZ1-UP	
Engine Oil	7W-2327		
Fuel Primary	163-4465		
Fuel Secondary	145-4501		
Hydraulic	126-1818		
Power Train	1G-8878	102-2828	156-0214
Air Primary	152-7217		
Air Secondary	152-7219		
924GZ Wheel Loader		3PZ1-UP	
Engine Oil	7W-2327		
Fuel Primary	163-4465		
Fuel Secondary	145-4501		
Hydraulic	126-1818		
Power Train	1G-8878	102-2828	156-0214
Air Primary	152-7217		
Air Secondary	152-7219		
924GZ Wheel Loader		6YW1-UP	
Engine Oil	7W-2327		
Fuel Primary	163-4465		
Fuel Secondary	145-4501		
Hydraulic	126-1818		
Power Train	1G-8878	102-2828	156-0214
Air Primary	152-7217		
Air Secondary	152-7219		

FILTER TYPE	PART NUMBER	HIGH EFFICIENCY	FIRE RESISTANT
924GZ Wheel Loader		9SW1-UP	
Engine Oil	7W-2327		
Fuel Primary	163-4465		
Fuel Secondary	145-4501		
Hydraulic	126-1818		
Power Train	1G-8878	102-2828	156-0214
Air Primary	152-7217		
Air Secondary	152-7219		
924GZ Wheel Loader		AAB1-UP	
Engine Oil	7W-2327		
Fuel Primary	163-4465		
Fuel Secondary	145-4501		
Hydraulic	126-1818		
Power Train	1G-8878	102-2828	156-0214
Air Primary	152-7217		
Air Secondary	152-7219		
924GZ Wheel Loader		AAN1-UP	
Engine Oil	7W-2327		
Fuel Primary	163-4465		
Fuel Secondary	145-4501		
Hydraulic	126-1818		
Power Train	1G-8878	102-2828	156-0214
Air Primary	152-7217		
Air Secondary	152-7219		
926 Wheel Loader		8NB1-UP	
Engine Oil	1R-0714		
Fuel Primary	9M-2341		
Fuel Secondary	1R-0750		
Hydraulic	1R-0722	139-1536	4T-3134
Power Train	1R-0746	126-1810	
Air Primary	7W-5389		
Air Secondary	8N-4901		
926 Wheel Loader		94Z1-2208	
Engine Oil	1R-0714		
Fuel Primary	9M-2341		
Fuel Secondary	1R-0750		
Hydraulic	1R-0722	139-1536	4T-3134
Power Train	1R-0746	126-1810	
Air Primary	7W-5389		
Air Secondary	8N-4901		
926E Wheel Loader		4NB3612-UP	
Engine Oil	1R-0714		
Fuel Primary	9M-2341		
Fuel Secondary	1R-0750		
Hydraulic	1R-0722	139-1536	4T-3134
Power Train	1R-0746	126-1810	
Air Primary	7W-5389		
Air Secondary	8N-4901		

a - For quantities, refer to parts book.

Filters - Wheel Loaders

FILTER TYPE	PART NUMBER	HIGH EFFICIENCY	FIRE RESISTANT
926E Wheel Loader		8NB1543-2451	
Engine Oil	1R-0714		
Fuel Primary	9M-2341		
Fuel Secondary	1R-0750		
Hydraulic	1R-0722	139-1536	4T-3134
Power Train	1R-0746	126-1810	
Air Primary	7W-5389		
Air Secondary	8N-4901		
926E Wheel Loader		8NB2452-UP	
Engine Oil	1R-0714		
Fuel Primary	9M-2341		
Fuel Secondary	1R-0750		
Power Train	1R-0746	126-1810	
Air Primary	7W-5389		
Air Secondary	8N-4901		
926E Wheel Loader		94Z2209-UP	
Engine Oil	1R-0714		
Fuel Primary	9M-2341		
Fuel Secondary	1R-0750		
Hydraulic	1R-0722	139-1536	4T-3134
Power Train	1R-0746	126-1810	
Air Primary	7W-5389		
Air Secondary	8N-4901		
926F Wheel Loader		4NB1-2075	
Engine Oil	1R-0714		
Fuel Primary	9M-2341		
Fuel Secondary	1R-0750		
Hydraulic	1R-0722	139-1536	4T-3134
Power Train	1R-0746	126-1810	
Air Primary	7W-5389		
Air Secondary	8N-4901		
928F Wheel Loader		2XL1-UP	
Engine Oil	1R-0739		
Fuel Primary	9M-2341		
Fuel Secondary	1R-0751		
Hydraulic	1R-0722	139-1536	4T-3134
Power Train	1G-8878	102-2828	156-0214
Air Primary	6I-2499		
Air Secondary	6I-2500		
928F Wheel Loader		8AK1-699	
Engine Oil	1R-0739		
Fuel Primary	9M-2341		
Fuel Secondary	1R-0750		
Hydraulic	1R-0722	139-1536	4T-3134
Power Train	1G-8878	102-2828	156-0214
Air Primary	6I-2499		
Air Secondary	6I-2500		

FILTER TYPE	PART NUMBER	HIGH EFFICIENCY	FIRE RESISTANT
928F Wheel Loader		8AK700-UP	
Engine Oil	1R-0739		
Fuel Primary	9M-2341		
Fuel Secondary	1R-0751		
Hydraulic	1R-0722	139-1536	4T-3134
Power Train	1G-8878	102-2828	156-0214
Air Primary	6I-2499		
Air Secondary	6I-2500		
928G Wheel Loader		6XR1-UP	
Engine Oil	1R-0739		
Fuel Primary	117-4089		
Fuel Primary	151-2409		
Fuel Secondary	1R-0751		
Fuel Secondary	1R-0753		
Hydraulic	126-1818		
Power Train	1G-8878	102-2828	156-0214
Air Primary	6I-2499		
Air Secondary	6I-2500		
928G Wheel Loader		7SR1-UP	
Engine Oil	1R-0739		
Fuel Primary	117-4089		
Fuel Secondary	1R-0751		
Hydraulic	126-1818		
Hydraulic	1G-8878	102-2828	156-0214
Power Train	1G-8878	102-2828	156-0214
Air Primary	6I-2499		
Air Secondary	6I-2500		
930 Wheel Loader		17B220-999	
Engine Oil	1R-0739		
Fuel Primary	9M-2341		
Fuel Secondary	1R-0750		
Hydraulic	1R-0741	132-8876	4T-3132
Hydraulic	3G-4621		
Power Train	1R-0746	126-1810	
Air Primary	7W-5389		
Air Secondary	2S-1285		
Air Secondary	8N-4901		
930R Wheel Loader		57Z1-3016	
Engine Oil	1R-0739		
Fuel Primary	9M-2341		
Fuel Secondary	1R-0750		
Hydraulic	1R-0741	132-8876	4T-3132
Hydraulic	3G-4621		
Power Train	1R-0746	126-1810	
Air Primary	7W-5389		
Air Secondary	2S-1285		
930R Wheel Loader		57Z3017-3999	
Engine Oil	1R-0739		

a - For quantities, refer to parts book.

Filters - Wheel Loaders

FILTER TYPE	PART NUMBER	HIGH EFFICIENCY	FIRE RESISTANT
930R Wheel Loader (cont.)		57Z3017-3999	
Fuel Primary	9M-2341		
Fuel Secondary	1R-0750		
Hydraulic	1R-0741	132-8876	4T-3132
Hydraulic	3G-4621		
Power Train	1R-0746	126-1810	
Air Primary	7W-5389		
Air Secondary	2S-1285		
930T Wheel Loader		17B1000-2010	
Engine Oil	1R-0739		
Fuel Primary	9M-2341		
Fuel Secondary	1R-0750		
Hydraulic	1R-0741	132-8876	4T-3132
Hydraulic	3G-4621		
Power Train	1R-0746	126-1810	
Air Primary	7W-5389		
Air Secondary	8N-4901		
930T Wheel Loader		57Z4000-UP	
Engine Oil	1R-0739		
Fuel Primary	9M-2341		
Fuel Secondary	1R-0750		
Hydraulic	1R-0741	132-8876	4T-3132
Hydraulic	3G-4621		
Power Train	1R-0746	126-1810	
Air Primary	7W-5389		
Air Secondary	8N-4901		
930T Series II Wheel Loader		17B2011-UP	
Engine Oil	1R-0739		
Fuel Primary	9M-2341		
Fuel Secondary	1R-0750		
Hydraulic	1R-0741	132-8876	4T-3132
Hydraulic	3G-4621		
Power Train	1R-0746	126-1810	
Air Primary	7W-5389		
Air Secondary	8N-4901		
936 Wheel Loader		4SB1-UP	
Engine Oil	1R-0739		
Fuel Primary	9M-2341		
Fuel Secondary	1R-0750		
Hydraulic	1R-0722	139-1536	4T-3134
Power Train	1R-0746	126-1810	
Air Primary	7W-5317		
Air Secondary	9S-9972		
936 Wheel Loader		33Z1-3090	
Engine Oil	1R-0739		
Fuel Primary	9M-2341		
Fuel Secondary	1R-0750		
Hydraulic	1R-0722	139-1536	4T-3134

FILTER TYPE	PART NUMBER	HIGH EFFICIENCY	FIRE RESISTANT
936 Wheel Loader (cont.)		33Z1-3090	
Power Train	1R-0746	126-1810	
Air Primary	7W-5317		
Air Secondary	9S-9972		
936 Wheel Loader		45Z1-3056	
Engine Oil	1R-0739		
Fuel Primary	9M-2341		
Fuel Secondary	1R-0750		
Hydraulic	1R-0722	139-1536	4T-3134
Power Train	1R-0746	126-1810	
Air Primary	7W-5317		
Air Secondary	9S-9972		
936E Wheel Loader		4SB1624-UP	
Engine Oil	1R-0739		
Fuel Primary	9M-2341		
Fuel Secondary	1R-0750		
Hydraulic	1R-0722	139-1536	4T-3134
Power Train	1R-0746	126-1810	
Air Primary	7W-5317		
Air Secondary	9S-9972		
936E Wheel Loader		33Z3091-UP	
Engine Oil	1R-0739		
Fuel Primary	9M-2341		
Fuel Secondary	1R-0750		
Hydraulic	1R-0722	139-1536	4T-3134
Hydraulic	4T-3134	126-1810	
Power Train	1R-0746		
Air Primary	7W-5317		
Air Secondary	9S-9972		
936E Wheel Loader		45Z3057-UP	
Engine Oil	1R-0739		
Fuel Primary	9M-2341		
Fuel Secondary	1R-0750		
Hydraulic	1R-0722	139-1536	4T-3134
Hydraulic	4T-3134		
Power Train	1R-0746	126-1810	
Air Primary	7W-5317		
Air Secondary	9S-9972		
936F Wheel Loader		4TK1-UP	
Engine Oil	1R-0739		
Fuel Primary	9M-2341		
Fuel Secondary	1R-0750		
Hydraulic	1R-0722	139-1536	4T-3134
Power Train	1R-0746	126-1810	
Air Primary	6I-2501		
Air Primary	7W-5317		
Air Secondary	6I-2502		
Air Secondary	9S-9972		

a - For quantities, refer to parts book.

Filters - Wheel Loaders

FILTER TYPE	PART NUMBER	HIGH EFFICIENCY	FIRE RESISTANT
936F Wheel Loader		8AJ1-UP	
Engine Oil	1R-0739		
Fuel Primary	9M-2341		
Fuel Secondary	1R-0750		
Hydraulic	1R-0722	139-1536	4T-3134
Power Train	1R-0746	126-1810	
Air Primary	6I-2501		
Air Primary	7W-5317		
Air Secondary	6I-2502		
Air Secondary	9S-9972		
936F Wheel Loader		9MK1-UP	
Engine Oil	1R-0739		
Fuel Primary	9M-2341		
Fuel Secondary	1R-0750		
Hydraulic	1R-0722	139-1536	4T-3134
Power Train	1R-0746	126-1810	
Air Primary	7W-5317		
Air Secondary	9S-9972		
938F Wheel Loader		1KM1-UP	
Engine Oil	1R-0739		
Fuel Primary	117-4089		
Fuel Primary	9M-2341		
Fuel Secondary	1R-0751		
Fuel Secondary	1R-0753		
Hydraulic	1R-0722	139-1536	4T-3134
Power Train	1G-8878	102-2828	156-0214
Air Primary	6I-2501		
Air Secondary	6I-2502		
938F Wheel Loader		2RM1-1232	
Engine Oil	1R-0739		
Fuel Primary	9M-2341		
Fuel Secondary	1R-0751		
Hydraulic	1R-0722	139-1536	4T-3134
Power Train	1G-8878	102-2828	156-0214
Air Primary	6I-2501		
Air Secondary	6I-2502		
938F Wheel Loader		2RM1291-UP	
Engine Oil	1R-0739		
Fuel Primary	117-4089		
Fuel Secondary	1R-0751		
Fuel Secondary	1R-0753		
Hydraulic	1R-0722	139-1536	4T-3134
Power Train	1G-8878	102-2828	156-0214
Air Primary	6I-2501		
Air Secondary	6I-2502		
938F Wheel Loader		7SN1-UP	
Engine Oil	1R-0739		
Fuel Primary	117-4089		

FILTER TYPE	PART NUMBER	HIGH EFFICIENCY	FIRE RESISTANT
938F Wheel Loader (cont.)		7SN1-UP	
Fuel Primary	9M-2341		
Fuel Secondary	1R-0751		
Fuel Secondary	1R-0753		
Hydraulic	1R-0722	139-1536	4T-3134
Power Train	1G-8878	102-2828	156-0214
Air Primary	6I-2501		
Air Secondary	6I-2502		
938F Wheel Loader		8SM1-UP	
Engine Oil	1R-0739		
Fuel Primary	9M-2341		
Fuel Secondary	1R-0751		
Hydraulic	1R-0722	139-1536	4T-3134
Power Train	1G-8878	102-2828	156-0214
Air Primary	6I-2501		
Air Secondary	6I-2502		
938G Wheel Loader		4YS1-UP	
Engine Oil	1R-0739		
Fuel Primary	117-4089		
Fuel Primary	151-2409		
Fuel Secondary	1R-0751		
Fuel Secondary	1R-0753		
Hydraulic	1R-0722	139-1536	4T-3134
Power Train	1G-8878	102-2828	156-0214
Air Primary	6I-2501		
Air Secondary	6I-2502		
938G Wheel Loader		6WS1-682	
Engine Oil	1R-0739		
Fuel Primary	117-4089		
Fuel Secondary	1R-0751		
Fuel Secondary	1R-0753		
Hydraulic	157-3862		
Hydraulic	1R-0722	139-1536	4T-3134
Power Train	1G-8878	102-2828	156-0214
Air Primary	128-2686		
Air Secondary	6I-2502		
938G Wheel Loader		6WS683-UP	
Engine Oil	1R-0739		
Fuel Primary	151-2409		
Fuel Secondary	1R-0751		
Fuel Secondary	1R-0753		
Hydraulic	157-3862		
Hydraulic	1R-0722	139-1536	4T-3134
Power Train	1G-8878	102-2828	156-0214
Air Primary	128-2686		
Air Secondary	6I-2502		
938G Wheel Loader		8RS1-610	
Engine Oil	1R-0739		

a - For quantities, refer to parts book.

Filters - Wheel Loaders

FILTER TYPE	PART NUMBER	HIGH EFFICIENCY	FIRE RESISTANT
938G Wheel Loader (cont.)			8RS1-610
Fuel Primary	117-4089		
Fuel Secondary	1R-0751		
Fuel Secondary	1R-0753		
Hydraulic	1R-0722	139-1536	4T-3134
Power Train	1G-8878	102-2828	156-0214
Air Primary	128-2686		
Air Secondary	6I-2502		
938G Wheel Loader			8RS611-UP
Engine Oil	1R-0739		
Fuel Primary	151-2409		
Fuel Secondary	1R-0751		
Fuel Secondary	1R-0753		
Hydraulic	1R-0722	139-1536	4T-3134
Power Train	1G-8878	102-2828	156-0214
Air Primary	128-2686		
Air Secondary	6I-2502		
938G Wheel Loader			9HS1-UP
Engine Oil	1R-0739		
Fuel Primary	117-4089		
Fuel Primary	151-2409		
Fuel Secondary	1R-0751		
Fuel Secondary	1R-0753		
Hydraulic	1R-0722	139-1536	4T-3134
Power Train	1G-8878	102-2828	156-0214
Air Primary	128-2686		
Air Secondary	6I-2502		
950B Wheel Loader			22Z1-3188
Engine Oil	1R-0739		
Fuel Primary	9M-2341		
Fuel Secondary	1R-0750		
Hydraulic	1R-0722	139-1536	4T-3134
Power Train	1R-0746	126-1810	
Air Primary	7W-5317		
Air Secondary	9S-9972		
950B Wheel Loader			31R1-UP
Engine Oil	1R-0739		
Fuel Primary	9M-2341		
Fuel Secondary	1R-0750		
Hydraulic	1R-0722	139-1536	4T-3134
Power Train	1R-0746	126-1810	
Air Primary	7W-5317		
Air Secondary	9S-9972		
950B Wheel Loader			63R1-6053
Engine Oil	1R-0739		
Fuel Primary	9M-2341		
Fuel Secondary	1R-0750		
Hydraulic	1R-0722	139-1536	4T-3134

FILTER TYPE	PART NUMBER	HIGH EFFICIENCY	FIRE RESISTANT
950B Wheel Loader (cont.)			63R1-6053
Power Train	1R-0746	126-1810	
Air Primary	7W-5317		
Air Secondary	9S-9972		
950B Wheel Loader			65R1-UP
Engine Oil	1R-0739		
Fuel Primary	9M-2341		
Fuel Secondary	1R-0750		
Hydraulic	1R-0722	139-1536	4T-3134
Power Train	1R-0746	126-1810	
Air Primary	7W-5317		
Air Secondary	9S-9972		
950E Wheel Loader			22Z3189-UP
Engine Oil	1R-0739		
Fuel Primary	9M-2341		
Fuel Secondary	1R-0750		
Hydraulic	1R-0722	139-1536	4T-3134
Power Train	1R-0746	126-1810	
Power Train	9T-9054	9T-7656	
Air Primary	7W-5317		
Air Secondary	9S-9972		
950E Wheel Loader			63R6054-UP
Engine Oil	1R-0739		
Fuel Primary	9M-2341		
Fuel Secondary	1R-0750		
Hydraulic	1R-0722	139-1536	4T-3134
Power Train	1R-0746	126-1810	
Power Train	9T-9054	9T-7656	
Air Primary	7W-5317		
Air Secondary	9S-9972		
950E Wheel Loader			65R3089-UP
Engine Oil	1R-0739		
Fuel Primary	9M-2341		
Fuel Secondary	1R-0750		
Hydraulic	1R-0722	139-1536	4T-3134
Power Train	1R-0746	126-1810	
Air Primary	7W-5317		
Air Secondary	9S-9972		
950F Wheel Loader			4DJ1-1999
Engine Oil	1R-0739		
Fuel Primary	9M-2341		
Fuel Secondary	1R-0750		
Hydraulic	1R-0722	139-1536	4T-3134
Power Train	9T-9054	9T-7656	
Air Primary	7W-5317		
Air Secondary	9S-9972		
950F Wheel Loader			6YG1-UP
Engine Oil	1R-0739		

a - For quantities, refer to parts book.

Filters - Wheel Loaders

FILTER TYPE	PART NUMBER	HIGH EFFICIENCY	FIRE RESISTANT
950F Wheel Loader (cont.)		6YG1-UP	
Fuel Primary	9M-2341		
Fuel Secondary	1R-0750		
Hydraulic	1R-0722	139-1536	4T-3134
Power Train	9T-9054	9T-7656	
Air Primary	7W-5317		
Air Secondary	9S-9972		
950F Wheel Loader		7ZF1-UP	
Engine Oil	1R-0739		
Fuel Primary	117-4089		
Fuel Primary	9M-2341		
Fuel Secondary	1R-0750		
Hydraulic	1R-0722	139-1536	4T-3134
Power Train	9T-9054	9T-7656	
Air Primary	7W-5317		
Air Secondary	9S-9972		
950F Series II Wheel Loader		2LM1-UP	
Engine Oil	1R-0739		
Fuel Primary	117-4089		
Fuel Primary	9M-2341		
Fuel Secondary	1R-0751		
Fuel Secondary	1R-0753		
Hydraulic	1R-0722	139-1536	4T-3134
Power Train	9T-9054	9T-7656	
Air Primary	6I-2501		
Air Secondary	6I-2502		
950F Series II Wheel Loader		4DJ2000-2864	
Engine Oil	1R-0739		
Fuel Primary	9M-2341		
Fuel Secondary	1R-0751		
Hydraulic	1R-0722	139-1536	4T-3134
Power Train	9T-9054	9T-7656	
Air Primary	6I-2501		
Air Secondary	6I-2502		
950F Series II Wheel Loader		4DJ2865-3960	
Engine Oil	1R-0739		
Fuel Primary	9M-2341		
Fuel Secondary	1R-0751		
Fuel Secondary	1R-0753		
Hydraulic	1R-0722	139-1536	4T-3134
Power Train	9T-9054	9T-7656	
Air Primary	6I-2501		
Air Secondary	6I-2502		
950F Series II Wheel Loader		5SK1-742	
Engine Oil	1R-0739		
Fuel Primary	9M-2341		
Fuel Secondary	1R-0750		
Hydraulic	1R-0722	139-1536	4T-3134

FILTER TYPE	PART NUMBER	HIGH EFFICIENCY	FIRE RESISTANT
950F Series II Wheel Loader (cont.)		5SK1-742	
Power Train	9T-9054	9T-7656	
Air Primary	6I-2501		
Air Secondary	6I-2502		
950F Series II Wheel Loader		5SK743-UP	
Engine Oil	1R-0739		
Fuel Primary	117-4089		
Fuel Secondary	1R-0751		
Fuel Secondary	1R-0753		
Hydraulic	1R-0722	139-1536	4T-3134
Hydraulic	4T-3134		
Power Train	9T-9054	9T-7656	
Air Primary	6I-2501		
Air Secondary	6I-2502		
950F Series II Wheel Loader		8TK1-4489	
Engine Oil	1R-0739		
Fuel Primary	9M-2341		
Fuel Secondary	1R-0751		
Fuel Secondary	1R-0753		
Hydraulic	1R-0722	139-1536	4T-3134
Power Train	9T-9054	9T-7656	
Air Primary	6I-2501		
Air Secondary	6I-2502		
950F Series II Wheel Loader		8TK4490-UP	
Engine Oil	1R-0739		
Fuel Primary	117-4089		
Fuel Secondary	1R-0751		
Fuel Secondary	1R-0753		
Hydraulic	1R-0722	139-1536	4T-3134
Power Train	9T-9054	9T-7656	
Air Primary	6I-2501		
Air Secondary	6I-2502		
950G Wheel Loader		2JS1-UP	
Engine Oil	1R-0739		
Fuel Primary	151-2409		
Fuel Secondary	1R-0751		
Fuel Secondary	1R-0753		
Hydraulic	157-3862		
Hydraulic	1G-8878	102-2828	156-0214
Hydraulic	4I-3948	126-1813	
Air Primary	128-2686		
Air Secondary	6I-2502		
950G Wheel Loader		3JW1-UP	
Engine Oil	1R-0739		
Fuel Primary	151-2409		
Fuel Secondary	1R-0751		
Fuel Secondary	1R-0753		
Hydraulic	1G-8878	102-2828	156-0214

a - For quantities, refer to parts book.

Filters - Wheel Loaders

FILTER TYPE	PART NUMBER	HIGH EFFICIENCY	FIRE RESISTANT
950G Wheel Loader (cont.)			3JW1-UP
Power Train	1G-8878	102-2828	156-0214
Air Primary	128-2686		
Air Secondary	6I-2502		
950G Wheel Loader			4BS1-UP
Engine Oil	1R-0739		
Fuel Primary	117-4089		
Fuel Primary	151-2409		
Fuel Secondary	1R-0751		
Fuel Secondary	1R-0753		
Hydraulic	1G-8878	102-2828	156-0214
Power Train	1G-8878	102-2828	156-0214
Air Primary	128-2686		
Air Secondary	6I-2502		
950G Wheel Loader			5FW1-UP
Engine Oil	1R-0739		
Fuel Primary	151-2409		
Fuel Secondary	1R-0751		
Fuel Secondary	1R-0753		
Hydraulic	157-3862		
Hydraulic	1G-8878	102-2828	156-0214
Power Train	1G-8878	102-2828	156-0214
Air Primary	128-2686		
Air Secondary	6I-2502		
950G Wheel Loader			5MW1-UP
Engine Oil	1R-0739		
Fuel Primary	151-2409		
Fuel Secondary	1R-0751		
Fuel Secondary	1R-0753		
Power Train	1G-8878	102-2828	156-0214
Air Primary	128-2686		
Air Secondary	6I-2502		
950G Wheel Loader			6NS1-UP
Engine Oil	1R-0739		
Fuel Primary	151-2409		
Fuel Secondary	1R-0751		
Fuel Secondary	1R-0753		
Power Train	1G-8878	102-2828	156-0214
Air Primary	128-2686		
Air Secondary	6I-2502		
950G Wheel Loader			8JW1-UP
Engine Oil	1R-0739		
Fuel Primary	151-2409		
Fuel Secondary	1R-0751		
Fuel Secondary	1R-0753		
Hydraulic	1G-8878	102-2828	156-0214
Power Train	1G-8878	102-2828	156-0214
Air Primary	128-2686		

FILTER TYPE	PART NUMBER	HIGH EFFICIENCY	FIRE RESISTANT
950G Wheel Loader (cont.)			8JW1-UP
Air Secondary	6I-2502		
960F Wheel Loader			1YM1-UP
Engine Oil	1R-0739		
Engine Oil	1W-8845		
Fuel Primary	117-4089		
Fuel Secondary	1R-0751		
Fuel Secondary	1R-0753		
Hydraulic	1R-0722	139-1536	4T-3134
Hydraulic	4T-3134		
Power Train	9T-9054	9T-7656	
Air Primary	6I-2501		
Air Secondary	6I-2502		
960F Wheel Loader			4CL1-446
Engine Oil	1R-0739		
Fuel Primary	9M-2341		
Fuel Secondary	1R-0751		
Fuel Secondary	1R-0753		
Hydraulic	1R-0722	139-1536	4T-3134
Power Train	9T-9054	9T-7656	
Air Primary	6I-2501		
Air Secondary	6I-2502		
960F Wheel Loader			4CL447-UP
Engine Oil	1R-0739		
Engine Oil	1W-8845		
Fuel Primary	117-4089		
Fuel Secondary	1R-0751		
Fuel Secondary	1R-0753		
Hydraulic	1R-0722	139-1536	4T-3134
Power Train	9T-9054	9T-7656	
Air Primary	6I-2501		
Air Secondary	6I-2502		
960F Wheel Loader			6XL1-272
Engine Oil	1R-0739		
Fuel Primary	9M-2341		
Fuel Secondary	1R-0751		
Hydraulic	1R-0722	139-1536	4T-3134
Power Train	9T-9054	9T-7656	
Air Primary	6I-2501		
Air Secondary	6I-2502		
960F Wheel Loader			6XL273-UP
Engine Oil	1R-0739		
Engine Oil	1W-8845		
Fuel Primary	9M-2341		
Fuel Secondary	1R-0751		
Fuel Secondary	1R-0753		
Hydraulic	1R-0722	139-1536	4T-3134
Power Train	9T-9054	9T-7656	

a - For quantities, refer to parts book.

Filters - Wheel Loaders

FILTER TYPE	PART NUMBER	HIGH EFFICIENCY	FIRE RESISTANT
960F Wheel Loader (cont.)		6XL273-UP	
Air Primary	6I-2501		
Air Secondary	6I-2502		
960F Wheel Loader		9ZJ1-UP	
Engine Oil	1R-0739		
Engine Oil	1W-8845		
Fuel Primary	117-4089		
Fuel Primary	9M-2341		
Fuel Secondary	1R-0750		
Fuel Secondary	1R-0751		
Fuel Secondary	1R-0753		
Hydraulic	1R-0722	139-1536	4T-3134
Power Train	9T-9054	9T-7656	
Air Primary	6I-2501		
Air Secondary	6I-2502		
962G Wheel Loader		3BS1-UP	
Engine Oil	1R-0739		
Engine Oil	1W-8845		
Fuel Primary	151-2409		
Fuel Secondary	1R-0751		
Fuel Secondary	1R-0753		
Hydraulic	157-3862		
Hydraulic	1G-8878	102-2828	156-0214
Hydraulic	4I-3948	126-1813	
Air Primary	128-2686		
Air Secondary	6I-2502		
962G Wheel Loader		4PW1-UP	
Engine Oil	1R-0739		
Engine Oil	1W-8845		
Fuel Primary	151-2409		
Fuel Secondary	1R-0751		
Fuel Secondary	1R-0753		
Power Train	1G-8878	102-2828	156-0214
Air Primary	128-2686		
Air Secondary	6I-2502		
962G Wheel Loader		5AS1-UP	
Engine Oil	1R-0739		
Engine Oil	1W-8845		
Fuel Primary	117-4089		
Fuel Primary	151-2409		
Fuel Secondary	1R-0751		
Fuel Secondary	1R-0753		
Hydraulic	1G-8878	102-2828	156-0214
Air Primary	128-2686		
Air Secondary	6I-2502		
962G Wheel Loader		5RS1-226	
Engine Oil	1R-0739		
Engine Oil	1W-8845		

FILTER TYPE	PART NUMBER	HIGH EFFICIENCY	FIRE RESISTANT
962G Wheel Loader (cont.)		5RS1-226	
Fuel Primary	117-4089		
Fuel Secondary	1R-0751		
Fuel Secondary	1R-0753		
Power Train	1G-8878	102-2828	156-0214
Air Primary	128-2686		
Air Secondary	6I-2502		
962G Wheel Loader		5RS227-UP	
Engine Oil	1R-0739		
Engine Oil	1W-8845		
Fuel Primary	151-2409		
Fuel Secondary	1R-0751		
Fuel Secondary	1R-0753		
Power Train	1G-8878	102-2828	156-0214
Air Primary	128-2686		
Air Secondary	6I-2502		
962G Wheel Loader		6EW1-UP	
Engine Oil	1R-0739		
Engine Oil	1W-8845		
Fuel Primary	151-2409		
Fuel Secondary	1R-0751		
Fuel Secondary	1R-0753		
Hydraulic	1G-8878	102-2828	156-0214
Power Train	1G-8878	102-2828	156-0214
Air Primary	128-2686		
Air Secondary	6I-2502		
962G Wheel Loader		6HW1-UP	
Engine Oil	1R-0739		
Engine Oil	1W-8845		
Fuel Primary	151-2409		
Fuel Secondary	1R-0751		
Fuel Secondary	1R-0753		
Power Train	1G-8878	102-2828	156-0214
Air Primary	128-2686		
Air Secondary	6I-2502		
962G Wheel Loader		7BW1-UP	
Engine Oil	1R-0739		
Engine Oil	1W-8845		
Fuel Primary	151-2409		
Fuel Secondary	1R-0751		
Fuel Secondary	1R-0753		
Hydraulic	157-3862		
Hydraulic	1G-8878	102-2828	156-0214
Power Train	1G-8878	102-2828	156-0214
Air Primary	128-2686		
Air Secondary	6I-2502		
962G Wheel Loader		BDP1-UP	
Engine Oil	1R-0739		

a - For quantities, refer to parts book.

Filters - Wheel Loaders

FILTER TYPE	PART NUMBER	HIGH EFFICIENCY	FIRE RESISTANT
962G Wheel Loader (cont.)		BDP1-UP	
Engine Oil	1W-8845		
Fuel Primary	151-2409		
Fuel Secondary	1R-0751		
Fuel Secondary	1R-0753		
Hydraulic	157-3862		
Hydraulic	1G-8878	102-2828	156-0214
Power Train	1G-8878	102-2828	156-0214
Air Primary	128-2686		
Air Secondary	6I-2502		
966C Wheel Loader		9KC1-UP	
Engine Oil	1R-0739		
Fuel Primary	8N-9803		
Fuel Primary	9M-2341		
Fuel Secondary	1R-0750		
Hydraulic	1R-0741	132-8876	4T-3132
Hydraulic	3G-4621		
Power Train	1R-0719	132-8875	4T-3131
Air Primary	7W-5317		
Air Secondary	2S-1286		
966C Wheel Loader		18B200-1265	
Engine Oil	1R-0739		
Fuel Primary	8N-9803		
Fuel Primary	9M-2341		
Fuel Secondary	1R-0750		
Hydraulic	1R-0741	132-8876	4T-3132
Hydraulic	3G-4621		
Power Train	1R-0719	132-8875	4T-3131
Air Primary	7W-5317		
Air Secondary	2S-1286		
966C Wheel Loader		18B1266-UP	
Engine Oil	1R-0739		
Fuel Primary	9M-2341		
Fuel Secondary	1R-0750		
Hydraulic	1R-0741	132-8876	4T-3132
Hydraulic	3G-4621		
Power Train	1R-0719	132-8875	4T-3131
Power Train	4S-8598		
Air Primary	7W-5317		
Air Secondary	2S-1286		
966D Wheel Loader		35S1-UP	
Engine Oil	1R-0739		
Fuel Primary	9M-2341		
Fuel Secondary	1R-0750		
Hydraulic	1R-0722	139-1536	4T-3134
Power Train	1R-0719	132-8875	4T-3131
Air Primary	7W-5317		
Air Secondary	9S-9972		

FILTER TYPE	PART NUMBER	HIGH EFFICIENCY	FIRE RESISTANT
966D Wheel Loader		94X1-6488	
Engine Oil	1R-0739		
Fuel Primary	9M-2341		
Fuel Secondary	1R-0750		
Hydraulic	1R-0722	139-1536	4T-3134
Power Train	1R-0719	132-8875	4T-3131
Air Primary	7W-5317		
Air Secondary	9S-9972		
966D Wheel Loader		99Y1-5314	
Engine Oil	1R-0739		
Fuel Primary	9M-2341		
Fuel Secondary	1R-0750		
Hydraulic	1R-0722	139-1536	4T-3134
Power Train	1R-0719	132-8875	4T-3131
Air Primary	7W-5317		
Air Secondary	9S-9972		
966E Wheel Loader		94X6489-UP	
Engine Oil	1R-0739		
Fuel Primary	9M-2341		
Fuel Secondary	1R-0750		
Hydraulic	1R-0722	139-1536	4T-3134
Power Train	1R-0719	132-8875	4T-3131
Air Primary	7W-5317		
Air Secondary	9S-9972		
966E Wheel Loader		99Y5315-UP	
Engine Oil	1R-0739		
Fuel Primary	9M-2341		
Fuel Secondary	1R-0750		
Hydraulic	1R-0722	139-1536	4T-3134
Power Train	1R-0719	132-8875	4T-3131
Air Primary	7W-5317		
Air Secondary	9S-9972		
966F Wheel Loader		1SL1-506	
Engine Oil	1R-0739		
Fuel Primary	9M-2341		
Fuel Secondary	1R-0750		
Hydraulic	1R-0722	139-1536	4T-3134
Power Train	1R-0719	132-8875	4T-3131
Air Primary	6I-2501		
Air Secondary	6I-2502		
966F Wheel Loader		3XJ1-UP	
Engine Oil	1R-0739		
Fuel Primary	9M-2341		
Fuel Secondary	1R-0750		
Hydraulic	1R-0722	139-1536	4T-3134
Power Train	1R-0719	132-8875	4T-3131
Air Primary	7W-5317		
Air Secondary	9S-9972		

a - For quantities, refer to parts book.

Filters - Wheel Loaders

FILTER TYPE	PART NUMBER	HIGH EFFICIENCY	FIRE RESISTANT
966F Wheel Loader		4YG1-UP	
Engine Oil	1R-0739		
Fuel Primary	9M-2341		
Fuel Secondary	1R-0750		
Hydraulic	1R-0722	139-1536	4T-3134
Power Train	1R-0719	132-8875	4T-3131
Air Primary	6I-2501		
Air Primary	7W-5317		
Air Secondary	6I-2502		
Air Secondary	9S-9972		
966F Wheel Loader		8BG1-1999	
Engine Oil	1R-0739		
Fuel Primary	9M-2341		
Fuel Secondary	1R-0750		
Hydraulic	1R-0722	139-1536	4T-3134
Power Train	1R-0719	132-8875	4T-3131
Air Primary	7W-5317		
Air Secondary	9S-9972		
966F Series II Wheel Loader		1SL507-UP	
Engine Oil	1R-0739		
Fuel Primary	9M-2341		
Fuel Secondary	1R-0750		
Hydraulic	1R-0722	139-1536	4T-3134
Power Train	1R-0719	132-8875	4T-3131
Air Primary	6I-2501		
Air Primary	6I-2503		
Air Secondary	6I-2502		
Air Secondary	6I-2504		
966F Series II Wheel Loader		7HL1-UP	
Engine Oil	1R-0739		
Fuel Primary	9M-2341		
Fuel Secondary	1R-0750		
Hydraulic	1R-0722	139-1536	4T-3134
Power Train	1R-0719	132-8875	4T-3131
Air Primary	6I-2501		
Air Secondary	6I-2502		
966F Series II Wheel Loader		8BG2000-2680	
Engine Oil	1R-0739		
Fuel Primary	9M-2341		
Fuel Secondary	1R-0750		
Hydraulic	1R-0722	139-1536	4T-3134
Power Train	1R-0719	132-8875	4T-3131
Air Primary	7W-5317		
Air Secondary	9S-9972		
966F Series II Wheel Loader		8BG2681-UP	
Engine Oil	1R-0739		
Fuel Primary	9M-2341		
Fuel Secondary	1R-0750		

FILTER TYPE	PART NUMBER	HIGH EFFICIENCY	FIRE RESISTANT
966F Series II Wheel Loader (cont.)		8BG2681-UP	
Hydraulic	1R-0722	139-1536	4T-3134
Power Train	1R-0719	132-8875	4T-3131
Air Primary	6I-2501		
Air Secondary	6I-2502		
966F Series II Wheel Loader		9YJ1-UP	
Engine Oil	1R-0739		
Fuel Primary	9M-2341		
Fuel Secondary	1R-0750		
Hydraulic	1R-0722	139-1536	4T-3134
Power Train	1R-0719	132-8875	4T-3131
Air Primary	6I-2501		
Air Primary	6I-2503		
Air Secondary	6I-2502		
Air Secondary	6I-2504		
966G Wheel Loader		3PW1-UP	
Engine Oil	1R-0739		
Fuel Primary	9M-2341		
Fuel Secondary	1R-0750		
Hydraulic	157-3862		
Hydraulic	1G-8878	102-2828	156-0214
Power Train	1R-0719	132-8875	4T-3131
Air Primary	6I-2503		
Air Secondary	6I-2504		
966G Wheel Loader		3SW1-UP	
Engine Oil	1R-0739		
Fuel Primary	9M-2341		
Fuel Secondary	1R-0750		
Hydraulic	1G-8878	102-2828	156-0214
Power Train	1R-0719	132-8875	4T-3131
Air Primary	6I-2503		
Air Secondary	6I-2504		
966G Wheel Loader		3ZS1-UP	
Engine Oil	1R-0739		
Fuel Primary	9M-2341		
Fuel Secondary	1R-0750		
Hydraulic	1G-8878	102-2828	156-0214
Power Train	1R-0719	132-8875	4T-3131
Air Primary	6I-2503		
Air Secondary	6I-2504		
966G Wheel Loader		8XW1-346	
Engine Oil	1R-0739		
Fuel Primary	9M-2341		
Fuel Secondary	1R-0750		
Hydraulic	1G-8878	102-2828	156-0214
Power Train	1R-0719	132-8875	4T-3131
Air Primary	6I-2503		
Air Secondary	6I-2504		

a - For quantities, refer to parts book.

Filters - Wheel Loaders

FILTER TYPE	PART NUMBER	HIGH EFFICIENCY	FIRE RESISTANT
966G Wheel Loader		8XW347-UP	
Engine Oil	1R-0739		
Fuel Primary	9M-2341		
Fuel Secondary	1R-0750		
Hydraulic	1G-8878	102-2828	156-0214
Power Train	1R-0719	132-8875	4T-3131
Air Primary	6I-2503		
Air Secondary	6I-2504		
966G Wheel Loader		9RS1-UP	
Engine Oil	1R-0739		
Fuel Primary	9M-2341		
Fuel Secondary	1R-0750		
Hydraulic	157-3862		
Hydraulic	1G-8878	102-2828	156-0214
Hydraulic	4I-3948	126-1813	
Power Train	1R-0719	132-8875	4T-3131
Air Primary	6I-2503		
Air Secondary	6I-2504		
966G Wheel Loader		AAH1-UP	
Engine Oil	1R-0739		
Fuel Primary	9M-2341		
Fuel Secondary	1R-0750		
Hydraulic	1G-8878	102-2828	156-0214
Power Train	1R-0719	132-8875	4T-3131
Air Primary	6I-2503		
Air Secondary	6I-2504		
966G Wheel Loader		HDH1-UP	
Engine Oil	1R-0739		
Fuel Primary	9M-2341		
Fuel Secondary	1R-0750		
Hydraulic	1G-8878	102-2828	156-0214
Power Train	1R-0719	132-8875	4T-3131
Air Primary	6I-2503		
Air Secondary	6I-2504		
966G Series II Wheel Loader		AXJ1-UP	
Engine Oil	1R-0716		
Fuel Primary	1R-0770		
Fuel Secondary	1R-0762		
Hydraulic	1G-8878	102-2828	156-0214
Power Train	1R-0719	132-8875	4T-3131
Air Primary	6I-2505		
Air Secondary	6I-2506		
966R Wheel Loader		58Z1-UP	
Engine Oil	1R-0739		
Fuel Primary	8N-9803		
Fuel Primary	9M-2341		
Fuel Secondary	1R-0750		
Hydraulic	1R-0741	132-8876	4T-3132

FILTER TYPE	PART NUMBER	HIGH EFFICIENCY	FIRE RESISTANT
966R Wheel Loader (cont.)		58Z1-UP	
Hydraulic	3G-4621		
Power Train	1R-0719	132-8875	4T-3131
970F Wheel Loader		7PL1-UP	
Engine Oil	1R-0739		
Fuel Primary	9M-2341		
Fuel Secondary	1R-0750		
Hydraulic	1R-0722	139-1536	4T-3134
Power Train	1R-0719	132-8875	4T-3131
Air Primary	6I-2503		
Air Secondary	6I-2504		
970F Wheel Loader		7SK1-UP	
Engine Oil	1R-0739		
Fuel Primary	9M-2341		
Fuel Secondary	1R-0750		
Hydraulic	1R-0722	139-1536	4T-3134
Power Train	1R-0719	132-8875	4T-3131
Air Primary	6I-2503		
Air Secondary	6I-2504		
970F Wheel Loader		9JK1-UP	
Engine Oil	1R-0739		
Fuel Primary	9M-2341		
Fuel Secondary	1R-0750		
Hydraulic	1R-0722	139-1536	4T-3134
Power Train	1R-0719	132-8875	4T-3131
Air Primary	6I-2503		
Air Secondary	6I-2504		
972G Wheel Loader		1EW1-UP	
Engine Oil	1R-0739		
Fuel Primary	9M-2341		
Fuel Secondary	1R-0750		
Hydraulic	157-3862		
Hydraulic	1G-8878	102-2828	156-0214
Hydraulic	4I-3948	126-1813	
Power Train	1R-0719	132-8875	4T-3131
Air Primary	6I-2503		
Air Secondary	6I-2504		
972G Wheel Loader		4WW1-UP	
Engine Oil	1R-0739		
Fuel Primary	9M-2341		
Fuel Secondary	1R-0750		
Hydraulic	1G-8878	102-2828	156-0214
Power Train	1R-0719	132-8875	4T-3131
Air Primary	6I-2503		
Air Secondary	6I-2504		
972G Wheel Loader		6AW1-UP	
Engine Oil	1R-0739		
Fuel Primary	9M-2341		

a - For quantities, refer to parts book.

Filters - Wheel Loaders

FILTER TYPE	PART NUMBER	HIGH EFFICIENCY	FIRE RESISTANT
972G Wheel Loader (cont.)			6AW1-UP
Fuel Secondary	1R-0750		
Hydraulic	157-3862		
Hydraulic	1G-8878	102-2828	156-0214
Power Train	1R-0719	132-8875	4T-3131
Air Primary	6I-2503		
Air Secondary	6I-2504		
972G Wheel Loader			7LS1-UP
Engine Oil	1R-0739		
Fuel Primary	9M-2341		
Fuel Secondary	1R-0750		
Hydraulic	1G-8878	102-2828	156-0214
Power Train	1R-0719	132-8875	4T-3131
Air Primary	6I-2503		
Air Secondary	6I-2504		
972G Wheel Loader			9GW1-UP
Engine Oil	1R-0739		
Fuel Primary	9M-2341		
Fuel Secondary	1R-0750		
Hydraulic	1G-8878	102-2828	156-0214
Power Train	1R-0719	132-8875	4T-3131
Air Primary	6I-2503		
Air Secondary	6I-2504		
972G Wheel Loader			AAW1-UP
Engine Oil	1R-0739		
Fuel Primary	9M-2341		
Fuel Secondary	1R-0750		
Hydraulic	1G-8878	102-2828	156-0214
Power Train	1R-0719	132-8875	4T-3131
Air Primary	6I-2503		
Air Secondary	6I-2504		
972G Series II Wheel Loader			AXC1-UP
Engine Oil	1R-0716		
Fuel Primary	1R-0770		
Fuel Secondary	1R-0762		
Hydraulic	1G-8878	102-2828	156-0214
Hydraulic	200-2672		
Hydraulic	4I-3948	126-1813	
Power Train	1R-0719	132-8875	4T-3131
Air Primary	6I-2505		
Air Secondary	6I-2506		
972G Series II Wheel Loader			AXN1-UP
Engine Oil	1R-0716		
Fuel Primary	1R-0770		
Fuel Secondary	1R-0762		
Hydraulic	1G-8878	102-2828	156-0214
Hydraulic	200-2672		
Power Train	1R-0719	132-8875	4T-3131

FILTER TYPE	PART NUMBER	HIGH EFFICIENCY	FIRE RESISTANT
972G Series II Wheel Loader (cont.)			AXN1-UP
Air Primary	6I-2505		
Air Secondary	6I-2506		
980C Wheel Loader			2XD1-UP
Engine Oil	1R-0716		
Fuel Primary	9M-2341		
Fuel Secondary	1R-0749		
Hydraulic	1R-0722	139-1536	4T-3134
Power Train	1R-0719	132-8875	4T-3131
Air Primary	7W-5495		
Air Secondary	1P-7360		
980C Wheel Loader			13B300-UP
Engine Oil	1R-0716		
Fuel Primary	9M-2341		
Fuel Secondary	1R-0749		
Hydraulic	1R-0722	139-1536	4T-3134
Power Train	1R-0719	132-8875	4T-3131
Air Primary	7W-5495		
Air Secondary	1P-7360		
980F Wheel Loader			3HK1-UP
Engine Oil	1R-0716		
Fuel Primary	9M-2341		
Fuel Secondary	1R-0749		
Hydraulic	1R-0722	139-1536	4T-3134
Power Train	1R-0719	132-8875	4T-3131
Air Primary	6I-0273		
Air Primary	7W-5495		
Air Secondary	1P-7360		
Air Secondary	6I-0274		
980F Wheel Loader			5XJ1-616
Engine Oil	1R-0716		
Fuel Primary	9M-2341		
Fuel Secondary	1R-0749		
Hydraulic	1R-0722	139-1536	4T-3134
Power Train	1R-0719	132-8875	4T-3131
Air Primary	7W-5495		
Air Secondary	1P-7360		
980F Wheel Loader			8CJ1-UP
Engine Oil	1R-0716		
Fuel Primary	9M-2341		
Fuel Secondary	1R-0749		
Hydraulic	1R-0722	139-1536	4T-3134
Power Train	1R-0719	132-8875	4T-3131
Air Primary	6I-0273		
Air Primary	7W-5495		
Air Secondary	1P-7360		
Air Secondary	6I-0274		

a - For quantities, refer to parts book.

Filters - Wheel Loaders

FILTER TYPE	PART NUMBER	HIGH EFFICIENCY	FIRE RESISTANT
980F Series II Wheel Loader			4RN1-UP
Engine Oil	1R-0716		
Fuel Primary	9M-2341		
Fuel Secondary	1R-0749		
Hydraulic	1R-0722	139-1536	4T-3134
Power Train	1R-0719	132-8875	4T-3131
Air Primary	7W-5495		
Air Secondary	1P-7360		
980F Series II Wheel Loader			5XJ617-UP
Engine Oil	1R-0716		
Fuel Primary	9M-2341		
Fuel Secondary	1R-0749		
Hydraulic	1R-0722	139-1536	4T-3134
Power Train	1R-0719	132-8875	4T-3131
Air Primary	6I-0273		
Air Secondary	6I-0274		
980F Series II Wheel Loader			8JN1-UP
Engine Oil	1R-0716		
Fuel Primary	9M-2341		
Fuel Secondary	1R-0749		
Hydraulic	1R-0722	139-1536	4T-3134
Power Train	1R-0719	132-8875	4T-3131
Air Primary	6I-0273		
Air Secondary	6I-0274		
980G Wheel Loader			2KR1-UP
Engine Oil	1R-0716		
Fuel Primary	9M-2341		
Fuel Secondary	1R-0749		
Hydraulic	1R-0722	139-1536	4T-3134
Power Train	1R-0719	132-8875	4T-3131
Air Primary	6I-0273		
Air Primary	6I-2505		
Air Secondary	6I-0274		
Air Secondary	6I-2506		
980G Wheel Loader			2SR1-650
Engine Oil	1R-0716		
Fuel Primary	9M-2341		
Fuel Secondary	1R-0749		
Hydraulic	1R-0722	139-1536	4T-3134
Power Train	1R-0719	132-8875	4T-3131
Air Primary	6I-0273		
Air Primary	6I-2505		
Air Secondary	6I-0274		
Air Secondary	6I-2506		
980G Wheel Loader			2SR651-UP
Engine Oil	1R-0716		
Fuel Primary	9M-2341		
Fuel Secondary	1R-0749		

FILTER TYPE	PART NUMBER	HIGH EFFICIENCY	FIRE RESISTANT
980G Wheel Loader (cont.)			2SR651-UP
Hydraulic	1R-0722	139-1536	4T-3134
Power Train	1R-0719	132-8875	4T-3131
Air Primary	6I-2505		
Air Secondary	6I-2506		
980G Wheel Loader			9CM1-UP
Engine Oil	1R-0716		
Fuel Primary	9M-2341		
Fuel Secondary	1R-0749		
Hydraulic	143-2849		
Hydraulic	1R-0722	139-1536	4T-3134
Power Train	1R-0719	132-8875	4T-3131
Air Primary	6I-0273		
Air Primary	6I-2505		
Air Secondary	6I-0274		
Air Secondary	6I-2506		
980G Series II Wheel Loader			AWH1-UP
Engine Oil	1R-0716		
Fuel Primary	1R-0770		
Fuel Secondary	1R-0762		
Hydraulic	102-2828		
Power Train	1R-0719	132-8875	4T-3131
Air Primary	6I-2505		
Air Secondary	6I-2506		
988F Wheel Loader			8YG1-UP
Engine Oil	1R-0716		
Fuel Primary	9M-2341		
Fuel Secondary	1R-0749		
Hydraulic	4T-6915		
Hydraulic	1R-0732	139-1535	4T-3133
Power Train	1R-0719	132-8875	4T-3131
Air Primary	6I-2505		
Air Secondary	6I-2506		
988F Series II Wheel Loader			2ZR1-UP
Engine Oil	1R-0716		
Fuel Secondary	1R-0749		
Hydraulic	4T-6915		
Hydraulic	1R-0732	139-1535	4T-3133
Power Train	1G-8878	102-2828	156-0214
Power Train	1R-0719	132-8875	4T-3131
Air Primary	6I-2505		
Air Secondary	6I-2506		
988G Wheel Loader			2TW1-UP
Engine Oil	1R-0716		
Fuel Primary	129-0373		
Fuel Secondary	1R-0749		
Hydraulic	126-1817		
Hydraulic	1G-8878	102-2828	156-0214

a - For quantities, refer to parts book.

Filters - Wheel Loaders

FILTER TYPE	PART NUMBER	HIGH EFFICIENCY	FIRE RESISTANT
988G Wheel Loader (cont.)		2TW1-UP	
Power Train	139-1535		
Power Train	1G-8878	102-2828	156-0214
Air Primary	6I-2509		
Air Secondary	6I-2510		
988G Wheel Loader		BNH1-UP	
Engine Oil	1R-0716		
Fuel Primary	129-0373		
Fuel Secondary	1R-0749		
Hydraulic	126-1817		
Hydraulic	1G-8878	102-2828	156-0214
Power Train	139-1535		
Power Train	1G-8878	102-2828	156-0214
Air Primary	6I-2509		
Air Secondary	6I-2510		
990 Wheel Loader		7HK1-UP	
Engine Oil	1R-0716		
Fuel Primary	9M-2342		
Fuel Secondary	1R-0749		
Hydraulic	4T-3134		
Power Train	132-8876		
Air Primary	6I-2505		
Air Secondary	6I-2506		
990 Series II Wheel Loader		4FR1-UP	
Engine Oil	1R-0716		
Fuel Primary	129-0373		
Fuel Secondary	1R-0749		
Hydraulic	4T-3134		
Power Train	132-8876		
Air Primary	6I-2505		
Air Secondary	6I-2506		
992C Wheel Loader		49Z1-UP	
Engine Oil	1R-0716		
Fuel Primary	9M-2342		
Fuel Secondary	1R-0749		
Hydraulic	1R-0719	132-8875	4T-3131
Hydraulic	1R-0728	139-1532	4T-3130
Hydraulic	1R-0732	139-1535	4T-3133
Power Train	1R-0741	132-8876	4T-3132
Air Primary	1P-8483		
Air Primary	7W-5313		
Air Secondary	1P-8482		
992D Wheel Loader		7MJ1-UP	
Engine Oil	1R-0716		
Fuel Primary	9M-2342		
Fuel Secondary	1R-0749		
Hydraulic	1R-0719	132-8875	4T-3131
Hydraulic	1R-0728	139-1532	4T-3130

FILTER TYPE	PART NUMBER	HIGH EFFICIENCY	FIRE RESISTANT
992D Wheel Loader (cont.)		7MJ1-UP	
Hydraulic	1R-0732	139-1535	4T-3133
Power Train	1R-0741	132-8876	4T-3132
Air Primary	6I-2505		
Air Primary	7W-5313		
Air Secondary	1P-8482		
Air Secondary	6I-2506		
992G Wheel Loader		7HR1-UP	
Engine Oil	1R-0716		
Fuel Primary	9M-2342		
Fuel Secondary	1R-0755		
Power Train	126-1817		
Power Train	132-8876		
Power Train	1G-8878	102-2828	156-0214
Air Primary	123-6855		
Air Secondary	123-6856		
992G Wheel Loader		ADZ1-UP	
Engine Oil	1R-0716		
Fuel Primary	9M-2342		
Fuel Secondary	1R-0755		
Hydraulic	126-1817		
Power Train	126-1817		
Power Train	132-8876		
Power Train	1G-8878	102-2828	156-0214
Air Primary	123-6855		
Air Secondary	123-6856		
994 Wheel Loader		9YF1-UP	
Engine Oil	2P-4005		
Fuel Primary	9M-2342		
Fuel Secondary	1R-0755		
Hydraulic	1R-0719	132-8875	4T-3131
Power Train	1G-8878	102-2828	156-0214
Power Train	1R-0741	132-8876	4T-3132
Air Primary	6I-2505		
Air Primary	7W-5313		
Air Secondary	6I-2506		
Air Secondary	6N-6444		
994D Wheel Loader		3TZ1-UP	
Engine Oil	2P-4005		
Fuel Primary	9M-2342		
Fuel Secondary	1R-0755		
Power Train	132-8876		
Power Train	1G-8878	102-2828	156-0214
Power Train	1R-0719	132-8875	4T-3131
Power Train	4T-3132		
Air Primary	6I-2505		
Air Secondary	6I-2506		

a - For quantities, refer to parts book.

Filters - Wheel Loaders

FILTER TYPE	PART NUMBER	HIGH EFFICIENCY	FIRE RESISTANT
G910 Wheel Loader			3SD1-UP
Engine Oil	1R-0713		
Fuel Secondary	1R-0710		
Fuel Secondary	1R-0750		
Hydraulic	1R-0719	132-8875	4T-3131
Air Primary	4N-0326		
Air Secondary	4N-0313		
G910 Wheel Loader			8GD1-UP
Engine Oil	1R-0713		
Fuel Secondary	1R-0710		
Fuel Secondary	1R-0750		
Hydraulic	1R-0719	132-8875	4T-3131
Power Train	1R-0746	126-1810	
Air Primary	4N-0326		
Air Secondary	4N-0313		
G916 Wheel Loader			5GD1-47
Engine Oil	1R-0714		
Fuel Primary	9M-2341		
Fuel Secondary	1R-0750		
Hydraulic	1R-0722	139-1536	4T-3134
Power Train	1R-0746	126-1810	
Air Primary	7W-5389		
Air Secondary	8N-4901		
G926 Wheel Loader			1SD1-73
Engine Oil	1R-0714		
Fuel Primary	9M-2341		
Fuel Secondary	1R-0750		
Hydraulic	1R-0722	139-1536	4T-3134
Power Train	1R-0746	126-1810	
Air Primary	7W-5389		
Air Secondary	8N-4901		
G936 Wheel Loader			3HD1-UP
Engine Oil	1R-0739		
Fuel Primary	9M-2341		
Fuel Secondary	1R-0750		
Hydraulic	1R-0722	139-1536	4T-3134
Hydraulic	4T-3134		
Power Train	1R-0746	126-1810	
Air Primary	7W-5317		
Air Secondary	9S-9972		
G936 Wheel Loader			4ND1-UP
Engine Oil	1R-0739		
Fuel Primary	9M-2341		
Fuel Secondary	1R-0750		
Hydraulic	1R-0722	139-1536	4T-3134
Power Train	1R-0746	126-1810	
Air Primary	7W-5317		
Air Secondary	9S-9972		

FILTER TYPE	PART NUMBER	HIGH EFFICIENCY	FIRE RESISTANT
G936 Wheel Loader			8ED1-UP
Engine Oil	1R-0739		
Fuel Primary	9M-2341		
Fuel Secondary	1R-0750		
Hydraulic	1R-0722	139-1536	4T-3134
Power Train	1R-0746	126-1810	
Air Primary	7W-5317		
Air Secondary	9S-9972		

a - For quantities, refer to parts book.

Ultra High Efficiency Radial Seal Filters

- Increase filter life.
- Provide higher initial efficiency than standard radial seal filters.
- For use in applications where extremely fine dust particles are a high percentage of the atmosphere contaminants.
- For use in operating conditions where high amounts of exhaust soot, which tend to plug normal filters at low hours, are encountered.

STANDARD RADIAL SEAL FILTER	ULTRA HIGH EFFICIENCY RADIAL SEAL FILTER
106-3969	132-7168
123-6855	132-7169
131-8822	134-0685
1W-3637	132-7172
4W-5228	132-7171
4W-5716	132-7170
6I-0273	122-1674
6I-2499	132-7164
6I-2501	128-2686
6I-2503	132-7165
6I-2505	122-1675
6I-2507	132-7166
6I-2509	132-7167
8N-6309	185-8786
9Y-7662	132-7173
—	156-9328 ^b

b - 950G conical air filter for severe applications



Air Filter Service Indicators

- Provide continuous checks on remaining filter capacity.
- Disengage when air flow restriction is highest under full load.

ITEM	PART NUMBER
Service Indicator	8N-2694
Service Indicator	1W-0613
Service Indicator (Truck Engine)	7W-7417

Filters

High Efficiency Hydraulic Cartridge Filters

STANDARD EFFICIENCY	HIGH EFFICIENCY	INTERMEDIATE	FIRE RESISTANT
094-3229	139-1539	n/a	n/a
094-4412	139-1540	n/a	n/a
109-7287	137-7249	n/a	n/a
126-2081	126-2131	n/a	n/a
134-0964	4C-6860	n/a	n/a
166-6892	167-2009	n/a	4T-3133
185-1379	185-1378	n/a	n/a
1R-0719	132-8875	1R-0773	4T-3131
1R-0722 ^d	139-1536	1R-0774	4T-3134
1R-0728	139-1532	1R-0775 ^C	4T-3130
1R-0729	139-1532	1R-0776 ^C	n/a
1R-0732	139-1535	1R-0792	4T-3133
1R-0735	139-1537	1R-0777	104-6931
1R-0741	132-8876	1R-0778	4T-3132
1R-0746	126-1810	1R-0779 ^C	n/a
9T-9054	9T-7656	n/a	n/a

c - Under development, to be released second quarter of 2002. d - Reverse flow filter. n/a = not applicable

High Efficiency Hydraulic Spin-on Filters

STANDARD EFFICIENCY	HIGH EFFICIENCY	FIRE RESISTANT
090-2900	126-1815	121-9868
108-1153	126-1817	134-3014
130-3212	126-1814	n/a
144-6691	126-1815	121-9868
152-6902	207-5035	n/a
185-0337	126-1814	n/a
1G-8878	102-2828	156-0214
4I-3948	126-1813	n/a
4I-3950	126-1814	n/a
6E-6408	126-1818	n/a
9T-0973	126-1817	134-3014
9T-6636	126-1816	n/a
9T-8578	144-0832	n/a
9U-5870 ^e	9U-6983 ^e	n/a
9U-6984 ^e	9U-6983 ^e	n/a
9U-6985 ^e	9U-6983 ^e	n/a

e - Not used in vehicles, used in service tool applications. n/a = not applicable



Filter Cutting Tool

- Cuts spin-on filters for inspection.

ITEM	PART NUMBER
Cutting Tool	175-7546
Replacement Cutting Wheel	177-0365
Insert-spacer	177-0366
Pin	177-0367
Roller	177-0364
Screw-flat Head Knob	7D-6921
Ring-retaining Handle	3D-7943



GROUND ENGAGING TOOLS - BACKHOE LOADER

Front Buckets	212
Front Bucket Bolt-On Edge	213
Front Bucket Bolt-On Adapters	213
Rear Buckets	214
Rear Bucket Base Edge and Corners	215
Rear Bucket Adapters	216
Tips	218

Ground Engaging Tools - Backhoe Loader Buckets

Front Buckets

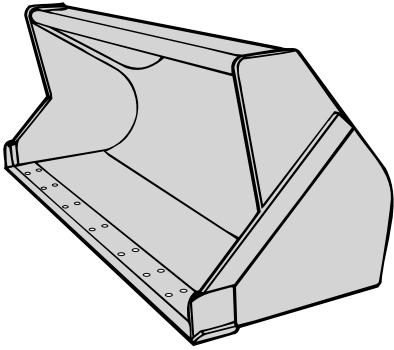

General Purpose Bucket

- For use in handling bank and stockpile materials.

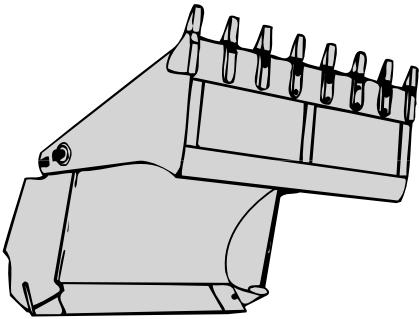

Multi-Purpose Bucket

- Provides more dump clearance and grabbing capabilities due to its movable clam.
- For use in general loading.

MODEL*	BASE EDGE		BASE EDGE	BUCKET CORNER	
	in	mm		LH	RH
416/416B/416C	88.0	2240	9R0316		
416C IT/416D/420	89.0	2262	9R4672	9R4674	9R4674
420D/426/426B	89.0	2262	9R4672	9R5205	9R5206
426C/426C IT/428	94.0	2388	9R5313	9R4674	9R4674
428B/428C IT/430D	94.3	2395	9R5313	9R5205	9R5206
436B/436C/436C IT	94.8	2408	9R4101	9R5748	9R5747
446/446B/446D	94.8	2408	6Q2193	6Q2196	6Q2197
	95.0	2413	9R4672		

*J225 Tip Size for Machine Models 446, 446B and 446D.
J200 for all other Bucket Types and Machine Models.

Ground Engaging Tools - Backhoe Loader Edges and Adapters

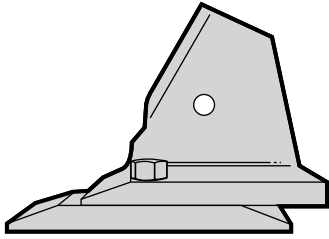

Front Bucket Bolt-On Edges

When penetration is not a problem, use bolt-on cutting edges. Bolt-on cutting edges:

- Increase base edge life up to five times over an unprotected base edge.
- Are quick and easy to replace.
- Increase bucket capacity.
- Provide smooth floor maintenance capability.
- Are made of DH-2 steel alloy and are hardened to 430-520 Brinell.

MODEL	BASE EDGE WIDTH		BASE EDGE**	BUCKET CORNER		BOLT-ON EDGE	BOLT	NUT
	in	mm		LH	RH			
416/416B/416C	88.0	2240	9R0316					
416C IT/416D/420	89.0	2262	9R4672	9R4674	9R4674	9W8215 (2)	3F5108 (8)	4K0367 (8)
420D/426/426B	89.0	2262	9R4672***	9R5205	9R5206	9W8215 (2)	3F5108 (8)	8E0367 (8)
426C/426C IT/428	94.0	2388	9R5313	9R4674	9R4674	1187110 (2)	3F5108 (8)	8E0367 (8)
428B/428C IT/430D	94.3	2395	9R5313	9R5205	9R5206	1187110 (2)	3F5108 (8)	8E0367 (8)
436B/436C/436C IT	94.8	2408	9R4101	9R5748	9R5747	9U9665 (2)	3F5188 (12)	4K0367 (12)
446/446B/446D	94.8	2408	6Q2193	6Q2196	6Q2197	9U9665 (2)	3F5188 (12)	4K0367 (12)
	95.0	2413	9R4672			9W8215 (2)	3F5108 (8)	4K0367 (8)

** Eight teeth for all bucket types and machine models except for 9R0316, 9R4101 and 6Q2193 base edges that have no teeth.

*** This base edge does not include teeth when used on 9R5988 bucket. The base edge is drilled for bolt-on unitooth tips. Number in parentheses () after the part number indicates the quantity required.

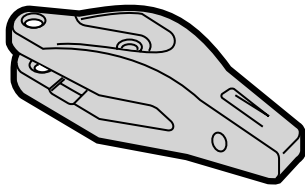

Front Bucket Bolt-On Adapters

- Provide excellent impact resistance.
- Provide excellent penetration ability.
- For use with larger backhoe loaders that work in abrasive conditions.

MODEL	BASE EDGE WIDTH		BASE EDGE**	BUCKET CORNER		BOLT-ON ADAPTER	BOLT	NUT
	in	mm		LH	RH			
416/416B/416C	88.0	2240	9R0316					
416C IT/416D/420	89.0	2262	9R4672	9R4674	9R4674	8E2184 (8)	4F3656 (16)	4K0367 (16)
420D/426/426B	89.0	2262	9R4672***	9R5205	9R5206	8E2184 (8)	4F3656 (16)	8E0367 (16)
426C/426C IT/428	94.0	2388	9R5313	9R4674	9R4674	8E2184 (8)	4F3656 (16)	8E0367 (16)
428B/428C IT/430D	94.3	2395	9R5313	9R5205	9R5206	8E2181 (8)	4F3656 (16)	8E0367 (16)
436B/436C/436C IT	94.8	2408	9R4101	9R5748	9R5747			
446/446B/446D	94.8	2408	6Q2193	6Q2196	6Q2197			
	95.0	2413	9R4672			8E2184 (8)	4F3656 (16)	4K0367 (16)

** Eight teeth for all bucket types and machine models except for 9R0316, 9R4101 and 6Q2193 base edges that have no teeth.

*** This base edge does not include teeth when used on 9R5988 bucket. The base edge is drilled for bolt-on unitooth tips. Number in parentheses () after the part number indicates the quantity required.

Ground Engaging Tools - Backhoe Loader Buckets

Rear Buckets

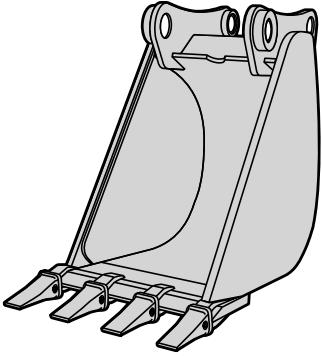

Standard Duty Bucket

- For use in handling bank and stockpile materials.

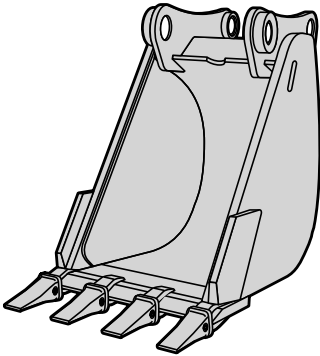

Heavy Duty Bucket

- Provides longer life in abrasive materials due to replaceable corners, a thicker base edge, and bottom wear strips.

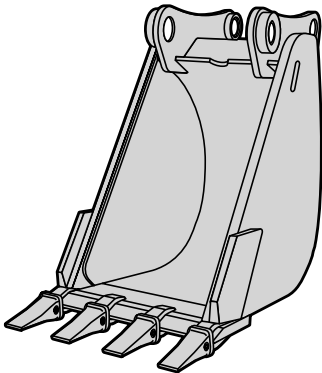

High Capacity Bucket

- Provides more capacity and a longer tip radius.
- Contains the same construction as the heavy duty bucket.
- For use in abrasive materials that are easily penetrated.

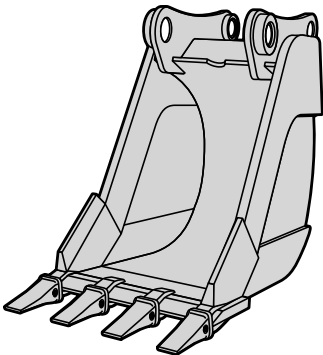

Extreme Service Bucket

- Contains heavy duty side plates, base edges, and corner adapters — in addition to sidebar protectors and bottom wear strips.
- For use in prying out rock and concrete.

Ground Engaging Tools - Backhoe Loader Base Edge and Corners

Rear Bucket - Base Edge and Corners*

MODEL	BASE EDGE WIDTH		BASE EDGE	BUCKET CORNER	
	in	mm		LH	RH
416/416B/416C 416C IT/416D/420 420D/426/426B 426C/426C IT/428 428B/428C IT/430D 436B/436C/436C IT 446/46B/ 446B/446D	12.0	305	1006002	9R8987	9R8988
			1345877	1345884	1345885
			1366886	1367150	1367150
			1743951		
			1545254	1345884	1345885
			1545254		
			1545268		
	16.0	406	1345878	1345884	1345885
	18.0	457	1345879		
			1345879	1345884	1345885
			1367046	1367051	1367049
			1367046		
			1366887	1366885	1366885
			1366887		
			9R8983	9R8987	9R8988
	9R9459	9R9456	9R9454		
	24.0	610	1345880	1345884	1345885
			1345880		
			1367047	1367051	1367049
			1367047		
			1366888	1366885	1366885
1366888					
9R9241			9R9819	9R9820	
9R9458			9R9456	9R9454	
9R8984			9R8987	9R8988	
30.0	762	9R8985	9R8987	9R8988	
		9R9833	9R9819	9R9820	
		1345881	1345884	1345885	
		1345881			
		136889	1366885	1366885	
		1366889			
		1728270			
9R9457	9R9456	9R9454			
36.0	914	1366890	1366885	1369885	
		1366890			
		1345882	1345884	1345885	
		1345882			
		9R8986	9R8987	9R8988	
9R9455	9R9456	9R9454			

* J225 for 446, 446B and 446D.
DRS for 416D, 420D, 430D.
J200 for all other machine models.

Ground Engaging Tools - Backhoe Loader Adapters

Rear Bucket Adapters

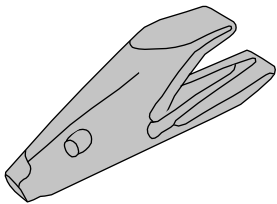

Weld-On Double Strap Adapters

- Provide good retention in high-impact conditions.
- Protect the base edge well.
- For use in general loading applications where adapter retention is more important than tire life.

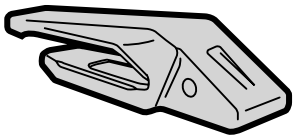

Bolt-On Adapters

- Provide excellent impact resistance.
- Provide excellent penetration ability.
- For use with larger backhoe loaders that work in abrasive conditions.

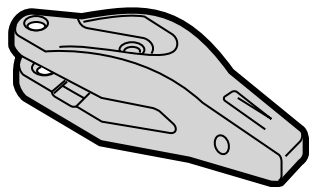

Ground Engaging Tools - Backhoe Loader Adapters

MODEL	BASE EDGE WIDTH		BASE EDGE	BUCKET CORNER		WELD-ON ADAPTER	WELD-ON DOUBLE STRAP ADAPTER	BOLT-ON ADAPTER	BOLT	NUT
	IN	MM		LH	RH					
416/416B/416C/416C IT 420/426/426B/426C 426C IT/428/428B 428C IT/436B/436C IT 446/446B/446D	12.0	305	1006002	9R8987	9R8988			8E2184 (3)	4F3656 (6)	4K0367 (6)
	12.0	305	1345877	1345884	1345885		1193204/1193205 (3)	8E2184 (3)	4F2184 (6)	4K0367 (6)
	12.0	305	1366886	1367150	1367150		1193204/1193205 (3)	8E2184 (3)	4F3656 (6)	4K0367 (3)
	16.0	406	1345878	1345884	1345885		1193204 (3)			
	18.0	457	1367046	1367051	1367049		1193204/1193205 (4 or 5)	8E2184 (3)	4F3656 (3)	4K0367 (6)
			1366887	1366885	1366885		1193204/1193205 (4 or 5)	8E2184 (3)	4F3656 (6)	4K0367 (6)
			9R8983*	9R8987	9R8988			8E2184 (3)	4F3656 (6)	4K0367 (6)
			9R9459	9R9456	9R9454		1193204/1193205 (4 or 5)	8E2184 (3)	4F3656 (6)	4K0367 (6)
		24.0	1345880	1345884	1345885		1193204 (5)			
			1367047	1367051	1367049		1193204/1193205 (4 or 5)	8E2184 (4 or 5)	4F2184 (8 or 10)	4K0367 (8 or 10)
416D/420D/430D			1366888	1366885	1366885		1193204/1193205 (4 or 5)	8E2184 (4 or 5)	4F3656 (8 or 10)	4K0367 (8 or 10)
			9R9241	9R9819	9R9820		1193204/1193205 (4 or 5)	8E2184 (4 or 5)	4F3656 (8 or 10)	4K0367 (8 or 10)
			9R9458	9R9456	9R9454		1193204/1193205 (4 or 5)	8E2184 (4 or 5)	4F3656 (8 or 10)	4K0367 (8 or 10)
			9R8984*	9R8987	9R8988			8E2184 (4 or 5)	4F3656 (8 or 10)	4K0367 (8 or 10)
		30.0	9R8985*	9R8987	9R8988		6Y3224 (5)	8E2184 (5 or 6)	4F3656 (10 or 12)	4K0367 (10 or 12)
			9R9833	9R9819	9R9820		6Y3224 (5)	8E2184 (5 or 6)	4F3656 (10 or 12)	4K0367 (10 or 12)
			1366889	1366885	1366885		6Y3224 (5)	8E2184 (5 or 6)	4F3656 (10 or 12)	4K0367 (10 or 12)
			9R9457	9R9456	9R9454		6Y3224 (5)	8E2184 (5 or 6)	4F3656 (10 or 12)	4K0367 (10 or 12)
		36.0	1366890	1366885	1366885		6Y3224 (6)	1193204/1193205 (6)	8E2184 (6)	4F3656 (1)
			9R8986*	9R8987	9R8988		6Y3224 (6)		8E2184 (6)	4F3656 (12)
			9R9455	9R9456	9R9454		6Y3224 (6)			
		305	1743951							
			1545254	1345884	1345885		1681204/1959204 (3)	1681204/1959204 (3)		
			1545268				1681204/1959204 (3)	1681204/1959204 (3)		
		16.0	1345878	1345884	1345885		1959204 (3)			
		18.0	1367046				1681204/1959204 (4)	1681204/1959204 (4)		
		457	1345879	1345884	1345885		1681204/1959204 (4)	1681204/1959204 (4)		
			1366887				1681204/1959204 (4)	1681204/1959204 (4)		
		24.0	1367047				1681204/1959204 (5)	1681204/1959204 (5)		
			1345880	1345884	1345885		1681204/1959204 (5)	1681204/1959204 (5)		
			1366888				1681204/1959204 (5)	1681204/1959204 (5)		
		762	1728270				1959204 (10)			
			1345881	1345884	1345885		1681204/1959204 (5)	1681204/1959204 (5)		
			1369889				1681204/1959204 (5)	1681204/1959204 (5)		
		36.0	1345882	1345884	1345885		1681204/1959204 (6)	1681204/1959204 (6)		
		1366890				1681204/1959204 (6)	1681204/1959204 (6)			

* Bucket does not include teeth. The base edge is drilled for Bolt-On Unitooth tips.
 ** Three, four, five, six or ten adapters/teeth depending on bucket application.

Number in parentheses () after the part number indicates the quantity required.

Ground Engaging Tools - Backhoe Loader Tips

Tips

Cat backhoe loader bucket tips are side pinned for excellent tip retention and quick, easy tip changing. The pin hole is located through the tip sides which are the areas of least wear.



Long Tip

- The best choice for most applications.



Short Tip

- Provides more strength.
- Contains less wear material.



Utility Tip

- For use in utility applications.



Wide Tip

- Contains less wear material.
- Provides less penetration.
- Provides a cleaner floor and less spillage.



Penetration Tip

- Provides better penetration.
- Contains less wear material.



Bolt-On Unitooth Tip

- Improves penetration where breakage is not a problem.
- Tip and adapter are one integrated piece for easy installation and lower initial costs.
- For use in nonabrasive materials.



Sharp Corner Tip / Sharp Center Tip

- Provides the best penetration.
- Contains the least wear material.

Ground Engaging Tools - Backhoe Loader Tips

Tips



Twin Sharp Tip

- For use for severe digging in rock and frost.



Heavy Duty Long Tip

- Contains more wear material than Abrasion Tip.
- Provides greater strength than Long Tip.
- Provides better penetration due to a streamlined-profile.



Heavy Duty Abrasion Tip

- Contain the greatest amount of wear material.
- Provides good strength.
- Provides good penetration.

Tips – Diagonal Retention System



DRS200

The new side-pinned system for all rear Backhoe Loader buckets except for the 446 model, provides good retention that is not affected by surface wear and easier installation where there is a tight clearance between tips.

- Proprietary (RH Drive).
- 20-30% more wear material vs. J200.
- Easy access for pin installation & removal (40°).
- Tight retention – no tooth rattling.

Ground Engaging Tools - Backhoe Loader Tips

Tips

Front Bucket Tips

	J200	J225
Heavy Duty Abrasion		6Y6223
Heavy Duty Long		8E4222
Long	1U3202	6Y3222
Penetration	1U3209	6Y8229
Short		6Y6221
Utility	7T8202	
Unitooth Center Tip	8J6207	
Unitooth Center Tip – Bolt	5J4771	
Unitooth Corner Tip (lh)	1U1868	
Unitooth Corner Tip (rh)	1U1869	
Unitooth Corner Tip – Bolt	6F0196	
Standard Pin	8E6208	6Y3228
Standard Retainer	8E6209	8E6259
Heavy Duty Pin		1324762
Heavy Duty Retainer		1495733

Rear Bucket Tips

	J200	J225	DRS200*
Chisel			1957202
Heavy Duty Abrasion		6Y6223	
Heavy Duty Long		8E4222	
Impact			1957205
Long	1U3202	6Y3222	1957206
Penetration	1U3209	6Y8229	
Sharp			1957209
Sharp Center	9W8209	6Y7229	
Sharp Center	9W8208	6Y7228	
Short		6Y6221	
Twin Sharp	1358208		1957207
Utility	7T8202		
Wide	1099200		1957210
Standard Pin	8E6208	6Y3228	
Standard Retainer	8E6209	8E6259	
Heavy Duty Pin		1324762	
Heavy Duty Retainer		1495733	
Flex Pin			1957200

* New expanded line to be introduced in June 2002. See your local Dealer for more information.



GROUND ENGAGING TOOLS - BULLDOZERS / COMPACTORS

Bulldozer Cutting Edges	222
Bulldozer End Bits	232
Bulldozer Wear Bars	239
Compactor Blades	243
Compactor Cutting Edges	244
Compactor End Bits	247
Landfill Compactor Plates and Tips	249
Landfill Compactor Wheel Assemblies	250
Compactor Feet	250
Cleaner Bars	251
Compactor Reinforcing Wear Plates	252

Ground Engaging Tools - Bulldozer Blades

Bulldozer Cutting Edges

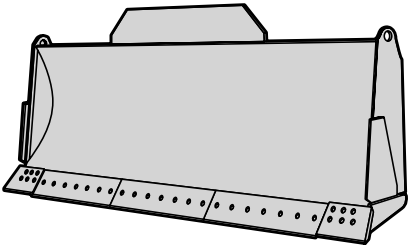

Straight Blade

- A good general purpose blade for most dozing applications. Available for most machines.

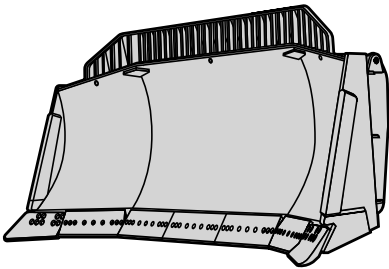

Universal Blade

- A straight blade with large “wings” to carry large loads more efficiently over long distances. Available only for larger models.

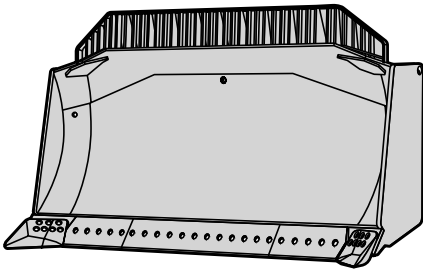

Semi-U Blade

- A straight blade with small “wings” to provide better load carrying characteristics for mid-sized and large machines.

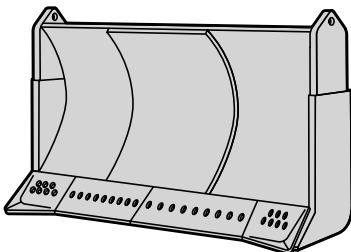

Cushion Blade

- A relatively narrow blade, primarily for pushing scrapers.

Ground Engaging Tools - Bulldozer Blades

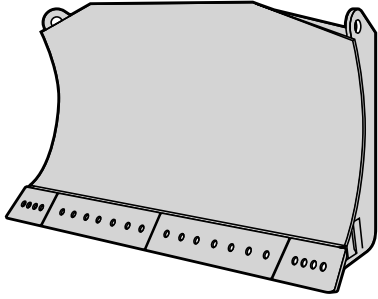

Power Angle and Tilt Blade

- A very versatile blade for smaller machines.

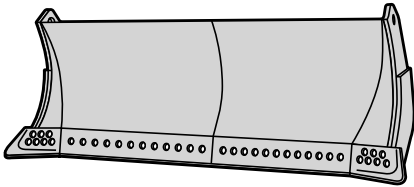

Angle Blade

- An economical, light to medium duty blade designed for use on D8 and smaller machines where the ability to side-cast is desired.

Ground Engaging Tools - Bulldozer Blades

MODEL	SERIAL NUMBER	BLADE MODEL	EDGE THICKNESS (in) (mm)	EDGE TYPE	EDGE PART NUMBER	BOLTS PER EDGE	NUTS PER EDGE	WASHERS PER EDGE
D3	1GP,2JP,6EH,9RH,85U,5LH	Power Angle & Tilt	0.62 16	Center Edge	4T-6230 (2)	3F-5108 (6)	4K-0367 (6)	5P-8247 (6)
	8HP,8KP	Power Angle & Tilt	0.62 16	Center Edge	6Y-5841 (2)	3F-5108 (6)	4K-0367 (6)	5P-8247 (6)
	31M,40V	Straight	0.62 16	Center Edge	4T-6231 (2)	3F-5108 (14)	4K-0367 (14)	5P-8247 (14)
D3 LGP	5WH,96X, 8JP	Power Angle & Tilt	0.62 16	Center Edge	4T-6232 (2)	3F-5108 (8)	4K-0367 (8)	5P-8247 (8)
	8XP	Power Angle & Tilt	0.62 16	Center Edge	141-0413 (2)	3F-5108 (8)	4K-0367 (8)	5P-8247 (8)
	2A,25F,67F	Straight	0.62 16	Center Edge	4T-2980	4F-3654 (15)	4K-0367 (15)	5P-8247 (15)
D4	2TC,3CH,3DC	Straight	0.62 16	Center Edge	4T-3720 (2)	5J-4773 (6)	2J-3506 (6)	5P-8248 (6)
	2YH	Power Angle & Tilt	0.62 16	Center Edge	4T-6230 (2)	3F-5108 (6)	4K-0367 (6)	5P-8247 (6)
	4A,40D	Straight	0.62 16	Center Edge	4T-2977	4F-3654 (18)	4K-0367 (18)	5P-8247 (18)
D4 LGP	4AC,9ZB,5NH,7EH	Power Angle & Tilt	0.62 16	Center Edge	4T-3021	4F-3654 (18)	4K-0367 (18)	5P-8247 (18)
	6CH	Power Angle & Tilt	0.62 16	Center Edge	3G-9306 (2)	5J-4773 (6)	2J-3506 (6)	5P-8248 (6)
	8LP	Power Angle & Tilt	0.62 16	Center Edge	6Y-5841 (2)	3F-5108 (6)	4K-0367 (6)	5P-8247 (6)
D5	9SH	Power Angle & Tilt	0.62 16	Center Edge	140-2187 (2)	3F-5108 (6)	4K-0367 (6)	5P-8247 (6)
	27F,67E,94G	Straight	0.62 16	Left End/Right End	104-9634 (2)	3F-5108 (6)	4K-0367 (6)	5P-8247 (6)
	93C	Straight	0.62 16	Center Edge	4T-2972	3F-5108 (4)	4K-0367 (4)	5P-8247 (4)
D4 LGP	4GH,8ZH,9YH	Power Angle & Tilt	0.62 16	Center Edge	4T-2983	3F-5108 (3)	4K-0367 (3)	5P-8247 (3)
	4HC	Straight	0.62 16	Center Edge	4T-3028	3F-5108 (4)	4K-0367 (4)	5P-8247 (4)
	5EC,5RH,7CH	Power Angle & Tilt	0.62 16	Center Edge	4T-3027	3F-5108 (3)	4K-0367 (3)	5P-8247 (3)
D5	6DH,9TH,8MP	Power Angle & Tilt	0.62 16	Center Edge	8A-8581	4F-3654 (7)	4K-0367 (7)	5P-8247 (7)
	8YP	Power Angle & Tilt	0.62 16	Center Edge	8A-8580	4F-3654 (7)	4K-0367 (7)	5P-8247 (7)
	2AH,2MH,7AH	Power Angle & Tilt	0.62 16	Center Edge	4T-6232 (2)	3F-5108 (8)	4K-0367 (8)	5P-8247 (8)
D5	2BH,4FH	Straight	0.62 16	Center Edge	4T-8940 (2)	5J-4773 (8)	2J-3506 (8)	5P-8248 (8)
	4GP,6JP	Power Angle & Tilt	0.62 16	Center Edge	4T-8940 (2)	5J-4773 (8)	2J-3506 (8)	5P-8248 (8)
	6MH,9WH	Power Angle & Tilt	0.62 16	Center Edge	6Y-5842 (2)	3F-5108 (8)	4K-0367 (8)	5P-8247 (8)
D5	7BH	Semi-U	0.75 19	Left End Edge/Right End	141-2238 (2)	3F-5108 (8)	4K-0367 (8)	5P-8247 (8)
	8GP	Power Angle & Tilt	0.62 16	Center Edge	3G-4282 (2)	5J-4773 (7)	2J-3506 (7)	5P-8248 (7)
		Power Angle & Tilt	0.62 16	Center Edge	3G-6062 (2)	5J-4773 (7)	2J-3506 (7)	5P-8248 (7)

Number in parentheses () after the part number indicates the quantity required. * Edges are 11" (280 mm) wide.

** Extended Wear Life edge. Edge is wider and contains offset bolt holes. Use only Extended Wear Life end bits.

Ground Engaging Tools - Bulldozer Blades

MODEL	SERIAL NUMBER	BLADE MODEL	EDGE THICKNESS (in)	EDGE THICKNESS (mm)	EDGE TYPE	EDGE PART NUMBER	BOLTS PER EDGE	NUTS PER EDGE	WASHERS PER EDGE	
D5 (cont.)	10J,12J,92H,97H	Straight	0.75	19	Left End /Right End	4T-3026	3F-5108 (4)	4K-0367 (4)	5P-8247 (4)	
					Center Edge	4T-3025	3F-5108 (7)	4K-0367 (7)	5P-8247 (7)	
	19R	Straight	0.75	19	Center Edge	4T-3024	3F-5108 (28)	4K-0367 (28)	5P-8247 (28)	
					Left End /Right End	4T-2972	3F-5108 (4)	4K-0367 (4)	5P-8247 (4)	
	90H	Straight	0.62	16	Center Edge	4T-2983	3F-5108 (3)	4K-0367 (3)	5P-8247 (3)	
					Left End /Right End	4T-3028	3F-5108 (4)	4K-0367 (4)	5P-8247 (4)	
	D5 LGP	1YH,2SH	Power Angle & Tilt	0.75	19	Center Edge	4T-3027	3F-5108 (3)	4K-0367 (3)	5P-8247 (3)
						Center Edge	4T-2315 (2)	5J-4773 (10)	2J-3506 (10)	5P-8248 (10)
		1ZH,3KH	Straight	0.75	19	Center Edge	1U-2211 (2)	5J-4773 (9)	2J-3506 (9)	5P-8248 (9)
						Center Edge	4T-8940 (2)	5J-4773 (8)	2J-3506 (8)	5P-8248 (8)
4FP		Power Angle & Tilt	0.62	16	Center Edge	6Y-5842 (2)	3F-5108 (8)	4K-0367 (8)	5P-8247 (8)	
					Center Edge	142-4914 (2)	3F-5108 (8)	4K-0367 (8)	5P-8247 (8)	
8ZP		Power Angle & Tilt	0.62	16	Center Edge	4T-0731 (2)	5J-4773 (5)	2J-3506 (5)	5P-8248 (5)	
					Center Edge	7T-9977 (3)	5J-4773 (7)	2J-3506 (7)	5P-8248 (7)	
4AH		Straight	Angle	1.00	25	Center Edge	4T-2985 (4)	5J-4773 (5)	2J-3506 (5)	5P-8248 (5)
						Center Edge	6Y-3840 (2)	5J-4773 (8)	2J-3506 (8)	5P-8248 (8)
D6	1BH1-569,3EH,4DH,4LH	Angle	0.75	19	Left End /Right End	4T-3010	5J-4773 (4)	2J-3506 (4)	5P-8248 (4)	
					Center Edge	4T-6659	5J-4773 (7)	2J-3506 (7)	5P-8248 (7)	
	1BH570-Up,3PP,4BP,1XP,3GP,1ZP	Semi-U	Straight	1.00	25	Left End /Right End	7T-9978	5J-4773 (4)	2J-3506 (4)	5P-8248 (4)
						Center Edge	7T-9976**	5J-4773 (7)	2J-3506 (7)	5P-8248 (7)
	1CH,2NH,4PH,1TP,3FP,1WP,3RP	Straight	Angle	1.00	25	Center Edge	4T-2985 (3)	5J-4773 (5)	2J-3506 (5)	5P-8248 (5)
						Center Edge	4T-3023	3F-5108 (22)	4K-0367 (22)	5P-8247 (22)
	1DH1-599,2HH,3JH,4BH	Straight	Angle Wide Custom	0.75	19	Center Edge	109-9093 (4)	5J-4773 (6)	2J-3506 (6)	5P-8248 (6)
						Center Edge	6Y-3840 (2)	5J-4773 (8)	2J-3506 (8)	5P-8248 (8)
	1DH600-Up,1RP,3EP	Straight	Semi-U	0.75	19	Center Edge	106-0956 (2)	5J-4473 (9)	2J-3506 (9)	5P-8248 (9)
						Center Edge	4T-3030 (2)	3F-5108 (12)	4K-0367 (12)	5P-8247 (12)
2G,3G,15E,36D,38D,39H,80D,85C	6HP	Semi-U (Wide XL)	0.75	19	Center Edge	4T-3021	3F-5108 (18)	4K-0367 (18)	5P-8247 (18)	
					Center Edge	4T-3010	4F-7827 (4)	2J-3506 (4)	5P-8248 (4)	
8AH,8BH	Angle	Straight	0.75	19	Center Edge	4T-3013	4F-7827 (7)	2J-3506 (7)	5P-8248 (7)	
					Center Edge	4T-3009 (2)	4F-7827 (12)	2J-3506 (12)	5P-8248 (12)	
8AH,8BH(Custom Wide)	Straight	Angle	0.75	19	Left End /Right end	4T-3010	4F-7827 (4)	2J-3506 (4)	5P-8248 (4)	
					Center Edge	4T-3011	4F-7827 (11)	2J-3506 (11)	5P-8248 (11)	
8E,9E,39D,82D	15C1-5000	Straight	1.00	25	Center Edge	7T-9976 (3)	5J-4773 (7)	2J-3506 (7)	5P-8248 (7)	
					Center Edge	4T-2984	5J-4771 (23)	2J-3506 (23)	5P-8248 (23)	
15C1-5000	17H,46G,55G,63S,95E	Straight	0.75	19	Center Edge	4T-2864	5J-4771 (23)	2J-3506 (23)	5P-8248 (23)	
					Center Edge					
18H,44E,47G,54U,58G	21H,41H	Angle	0.75	19	Center Edge					
					Center Edge					
D6 LGP	1AH,2LH,3FH,1SP,3HP	Straight	1.00	25	Center Edge					
					Center Edge					
D7	2E,5A,17C1-5000,17E,34D,83D,84C	Straight	0.75	19	Center Edge					
					Center Edge					

Number in parentheses () after the part number indicates the quantity required.
 ** Extended Wear Life edge. Edge is wider and contains offset bolt holes. Use only Extended Wear Life end bits.
 * Edges are 11" (280 mm) wide.

Ground Engaging Tools - Bulldozer Blades

MODEL	SERIAL NUMBER	BLADE MODEL	EDGE THICKNESS (in) (mm)	EDGE TYPE	EDGE PART NUMBER	BOLTS PER EDGE	NUTS PER EDGE	WASHERS PER EDGE
D7 (cont)	2FC,2JH,4DB,1JP,8LH	Semi-U	1.00 25	Left End/Right End	7T-6936	6F-0196 (4)	2J-3505 (4)	5P-8249 (4)
			1.38 35	Center Edge	7T-6678*	6F-0196 (6)	2J-3505 (6)	5P-8249 (6)
	3CC,4EB,4ZC	Angle	1.00 25	Left End/Right End	107-3362	6F-0196 (4)	2J-3505 (4)	5P-8249 (4)
			1.00 25	Center Edge	107-3363	6F-0196 (6)	2J-3505 (6)	5P-8249 (6)
	5SB,7AC,9JB,8MH	Universal	1.00 25	Left End/Right End	7T-6589 (3)*	6F-0196 (7)	2J-3505 (7)	5P-8249 (7)
			1.00 25	Center Edge	7T-6592	6F-0196 (4)	2J-3505 (4)	5P-8249 (4)
	6A,17C5001-Up	Angle	1.00 25	Left End/Right End	7T-6591 (2)*	6F-0196 (6)	2J-3505 (6)	5P-8249 (6)
			1.00 25	Center Edge	4T-2863 (2)	5J-4771 (15)	2J-3506 (15)	5P-8248 (15)
	6KB,8ZB,4XC,8NH	Straight	1.38 35	Center Edge	107-3363 (3)	6F-0196 (6)	2J-3505 (6)	5P-8249 (6)
			1.00 25	Center Edge	4T-2989 (3)	5J-4771 (7)	2J-3506 (7)	5P-8248 (7)
	13F,13H,22F,30F,72F	Angle	1.00 25	Center Edge	9W-9796 (3)*	5J-4771 (7)	2J-3506 (7)	5P-8248 (7)
			1.00 25	Center Edge	4T-2991	5J-4773 (5)	2J-3506 (5)	5P-8248 (5)
	23F,31F	Straight	1.00 25	Left End/Right End	4T-2990	5J-4773 (7)	2J-3506 (7)	5P-8248 (7)
			1.00 25	Center Edge	4T-2985	5J-4773 (5)	2J-3506 (5)	5P-8248 (5)
42G	Universal	1.00 25	Left End/Right End	4T-2890	5J-4773 (9)	2J-3506 (9)	5P-8248 (9)	
		1.00 25	Center Edge	9W-9794	5J-4772 (5)	2J-3505 (5)	5P-8249 (5)	
49K,53J	Straight	1.00 25	Left End/Right End	9W-9794*	5J-4772 (7)	2J-3505 (7)	5P-8249 (7)	
		1.00 25	Center Edge	4T-2992	6F-0196 (5)	2J-3505 (5)	5P-8249 (5)	
49K,53J,60K,64K	Straight	1.00 25	Left End/Right End	4T-2993	6F-0196 (7)	2J-3505 (7)	5P-8249 (7)	
		1.00 25	Center Edge	9W-9794	5J-4772 (5)	2J-3505 (5)	5P-8249 (5)	
60K,64K	Straight	1.00 25	Left End/Right End	9W-9795*	5J-4772 (7)	2J-3505 (7)	5P-8249 (7)	
		1.00 25	Center Edge	4T-7109	5J-4772 (5)	2J-3505 (5)	5P-8249 (5)	
61K,85D,94R	Universal	1.00 25	Left End/Right End	4T-7110	5J-4772 (9)	2J-3505 (9)	5P-8249 (9)	
		1.00 25	Center Edge	7T-6592*	5J-4772 (5)	2J-3505 (5)	5P-8249 (5)	
D7 LGP	2RP,8RH,5SP,9KP	Straight	1.00 25	Center Edge	7T-6591*	5J-4772 (9)	2J-3505 (9)	5P-8249 (9)
			1.00 25	Center Edge	7T-6589 (3)*	6F-0196 (7)	2J-3505 (7)	5P-8249 (7)
D8	3GH,4FG,6JB	Straight	1.00 25	Center Edge	135-6537 (3)	6F-0196 (7)	2J-3505 (7)	5P-8249 (7)
			1.16 28	Center Edge	9W-5432 (3)	4J-9058 (8)	2J-3507 (8)	5P-8250 (8)
	1HP,2NP,6LH,9BH,9PH,1KH,2PP,2TP,3MP,3WH	Angle	1.38 35	Center Edge	9W-9098 (3)	4J-9058 (8)	2J-3507 (8)	5P-8250 (8)
			1.38 35	Left End/Right End	7T-9125	4J-9058 (5)	2J-3507 (5)	5P-8250 (5)
1JH,2WP,6AH,9CH	Semi-U	Universal	1.38 35	Center Edge	7T-9126	4J-9058 (9)	2J-3507 (9)	5P-8250 (9)
			1.38 35	Left End/Right End	7T-9127	4J-9058 (5)	2J-3507 (5)	5P-8250 (5)
D7 LGP	3GH,4FG,6JB	Straight	1.00 25	Center Edge	9W-6092 (2)	4J-9058 (6)	2J-3507 (6)	5P-8250 (6)
			1.77 45	Left End/Right End	112-2473	4J-9058 (5)	2J-3507 (5)	5P-8250 (5)
D8	1JH,2WP,6AH,9CH	Universal	1.00 25	Center Edge	112-2475 (2)**	4J-9058 (6)	2J-3507 (6)	5P-8250 (6)
			1.77 45	Left End/Right End	112-2475 (2)**	4J-9058 (6)	2J-3507 (6)	5P-8250 (6)

Number in parentheses () after the part number indicates the quantity required.

** Extended Wear Life edge. Edge is wider and contains offset bolt holes. Use only Extended Wear Life end bits.

* Edges are 11" (280 mm) wide.

Ground Engaging Tools - Bulldozer Blades

MODEL	SERIAL NUMBER	BLADE MODEL	EDGE THICKNESS (in)	EDGE THICKNESS (mm)	EDGE TYPE	EDGE PART NUMBER	BOLTS PER EDGE	NUTS PER EDGE	WASHERS PER EDGE	
D8 (cont)	3E,8A,12C,18C,32D,44C1-1192,86D	Semi-U	0.75	19	Center Edge	4T-2944 (2)	1J-6762 (13)	2J-3506 (13)	5P-8248 (13)	
			1.00	25	Center Edge	4T-2860 (2)	1J-6762 (13)	2J-3506 (13)	5P-8248 (13)	
		4Y1-1939	Semi-U	1.12	28	Left End/Right End	4T-3417	4J-9208 (5)	2J-3507 (5)	5P-8250 (5)
				1.38	35	Center Edge	4T-3423 (2)	4J-9208 (6)	2J-3507 (6)	5P-8250 (6)
		4Y1940-Up	Semi-U	1.38	35	Left End/Right End	1U-4929	4J-9208 (5)	2J-3507 (5)	5P-8250 (5)
				1.38	35	Center Edge	1U-4930 (2)	4J-9208 (6)	2J-3507 (6)	5P-8250 (6)
	1.62			41	Left End/Right End	6Y-6359*	4J-9208 (5)	2J-3507 (5)	5P-8250 (5)	
	1.62			41	Center Edge	6Y-6358 (2)*	4J-9208 (6)	2J-3507 (6)	5P-8250 (6)	
	1.77			45	Left End/Right End	7T-4346*	4J-9208 (5)	2J-3507 (5)	5P-8250 (5)	
	1.77			45	Center Edge	7T-5235*	4J-9208 (6)	2J-3507 (6)	5P-8250 (6)	
	5Y,27B,41Z	Semi-U	1.38	35	Left End/Right End	107-3482	4J-9208 (5)	2J-3507 (5)	5P-8250 (5)	
			1.38	35	Center Edge	107-3480 (2)	4J-9208 (6)	2J-3507 (6)	5P-8250 (6)	
1.77			45	Left End/Right End	9W-4398	4J-9058 (5)	2J-3507 (5)	5P-8250 (5)		
1.77			45	Center Edge	9W-4396	4J-9058 (11)	2J-3507 (11)	5P-8250 (11)		
1.00			25	Left End/Right End	9W-3927	4J-9058 (5)	2J-3507 (5)	5P-8250 (5)		
1.00			25	Center Edge	9W-3925	4J-9058 (11)	2J-3507 (11)	5P-8250 (11)		
6Y1-1395		Universal	1.38	35	Left End/Right End	4T-2987	4J-9208 (6)	2J-3507 (6)	5P-8250 (6)	
			1.38	35	Center Edge	4T-2988 (2)	4J-9208 (7)	2J-3507 (7)	5P-8250 (7)	
			1.38	35	Left End Edge/Right End	9W-8657	4J-9208 (6)	2J-3507 (6)	5P-8250 (6)	
			1.38	35	Center Edge	9W-8655 (2)*	4J-9208 (7)	2J-3507 (7)	5P-8250 (7)	
			1.38	35	Left End/Right End	1U-4932	4J-9208 (6)	2J-3507 (6)	5P-8250 (6)	
			1.38	35	Center Edge	1U-4933 (2)	4J-9208 (7)	2J-3507 (7)	5P-8250 (7)	
6Y1-1395	Universal	1.62	41	Left End/Right End	7T-4352	4J-9208 (6)	2J-3507 (6)	5P-8250 (6)		
		1.77	45	Center Edge	7T-4353 (2)**	4J-9208 (7)	2J-3507 (7)	5P-8250 (7)		
		1.38	35	Left End/Right End	107-3481	4J-9208 (6)	2J-3507 (6)	5P-8250 (6)		
		1.38	35	Center Edge	107-3479 (2)	4J-9208 (7)	2J-3507 (7)	5P-8250 (7)		
		1.38	35	Left End/Right End	1U-4929	4J-9208 (5)	2J-3507 (5)	5P-8250 (5)		
		1.38	35	Center Edge	1U-4931 (2)	4J-9208 (7)	2J-3507 (7)	5P-8250 (7)		
	6Y1-1395	Universal	1.38	35	Left End/Right End	6Y-6359*	4J-9208 (5)	2J-3507 (5)	5P-8250 (5)	
			1.62	41	Center Edge	6Y-6360 (2)*	4J-9208 (7)	2J-3507 (7)	5P-8250 (7)	
			1.62	41	Left End Edge/Right End	7T-4346*	4J-9208 (5)	2J-3507 (5)	5P-8250 (5)	
			1.77	45	Center Edge	7T-4347 (2)*	4J-9208 (7)	2J-3507 (7)	5P-8250 (7)	
			1.77	45	Left End/Right End	107-3480	4J-9208 (5)	2J-3507 (5)	5P-8250 (5)	
			1.77	45	Center Edge	107-3483 (2)	4J-9208 (7)	2J-3507 (7)	5P-8250 (7)	

Number in parentheses () after the part number indicates the quantity required.
 ** Extended Wear Life edge. Edge is wider and contains offset bolt holes. Use only Extended Wear Life end bits.
 * Edges are 11" (280 mm) wide.

Ground Engaging Tools - Bulldozer Blades

MODEL	SERIAL NUMBER	BLADE MODEL	EDGE THICKNESS (in) (mm)	EDGE TYPE	EDGE PART NUMBER	BOLTS PER EDGE	NUTS PER EDGE	WASHERS PER EDGE
D8 (cont.)	6Y1396-Up	Universal	1.38 35	Left End/Right End	9W-4398	4J-9058 (5)	2J-3507 (5)	5P-8250 (5)
			1.77 45	Center Edge	9W-4397	4J-9058 (14)	2J-3507 (14)	5P-8250 (14)
			1.38 35	Left End/Right End	9W-3927	4J-9058 (5)	2J-3507 (5)	5P-8250 (5)
			1.38 35	Center Edge	9W-3926**	4J-9058 (14)	2J-3507 (14)	5P-8250 (14)
	11C,24E,74D,88D	Universal	1.38 35	Left End/Right End	6Y-6761	5J-2409 (6)	2J-3505 (6)	5P-8249 (6)
			1.38 35	Center Edge	6Y-6765	5J-2409 (10)	2J-3505 (10)	5P-8249 (10)
			1.57 40	Center Edge	6Y-6763 (2)	5J-2409 (10)	2J-3505 (10)	5P-8249 (10)
			1.77 45	Center Edge	6Y-5777 (2)*	5J-2409 (10)	2J-3505 (10)	5P-8249 (10)
	20F,45K,48K	Universal	1.38 35	Left End/Right End	107-3476 (2)	5J-2409 (6)	2J-3505 (6)	5P-8249 (6)
			1.77 45	Center Edge	6Y-6762	5J-2409 (10)	2J-3505 (10)	5P-8249 (10)
			1.38 35	Left End/Right End	6Y-6765	5J-2409 (6)	2J-3505 (6)	5P-8249 (6)
			1.77 45	Center Edge	107-3475	5J-2409 (10)	2J-3505 (10)	5P-8249 (10)
	29E,78C,94E	Semi-U	1.38 35	Center Edge	107-3478	5J-2409 (10)	2J-3505 (10)	5P-8249 (10)
			1.57 40	Center Edge	6Y-6764 (2)	5J-2409 (14)	2J-3505 (14)	5P-8249 (14)
			1.77 45	Center Edge	6Y-5776 (2)*	5J-2409 (14)	2J-3505 (14)	5P-8249 (14)
			1.77 45	Center Edge	107-3477 (2)	5J-2409 (14)	2J-3505 (14)	5P-8249 (14)
	29J,30E,73E	Universal	1.77 45	Left End/Right End	107-3474	5J-2409 (6)	2J-3505 (6)	5P-8249 (6)
			1.38 35	Center Edge	107-3478	5J-2409 (10)	2J-3505 (10)	5P-8249 (10)
			1.62 41	Center Edge	9W-8657 (3)	4J-9058 (7)	2J-3507 (7)	5P-8250 (7)
			1.77 45	Center Edge	7T-4353 (3)*	4J-9208 (7)	2J-3507 (7)	5P-8250 (7)
30V,34W,65X,69V	Universal	1.00 25	Center Edge	107-3479 (3)	4J-9208 (7)	2J-3507 (7)	5P-8250 (7)	
		1.38 35	Left End/Right End	9W-8657	4J-9058 (6)	2J-3507 (6)	5P-8250 (6)	
		1.38 35	Center Edge	9W-8656 (2)	4J-9058 (5)	2J-3507 (5)	5P-8250 (5)	
		1.77 45	Left End/Right End	9W-8656	4J-9058 (5)	2J-3507 (5)	5P-8250 (5)	
44C1193-Up,73D	Universal	1.00 25	Center Edge	9W-8655 (2)	4J-9058 (6)	2J-3507 (6)	5P-8250 (6)	
		1.38 35	Left End/Right End	107-3481	4J-9058 (6)	2J-3507 (6)	5P-8250 (6)	
		1.77 45	Center Edge	107-3473 (2)	4J-9058 (5)	2J-3507 (5)	5P-8250 (5)	
		1.77 45	Left End/Right End	7T-4349*	4J-9208 (5)	2J-3507 (5)	5P-8250 (5)	
1LH,1MP,2ZH,7PH	Semi-U	1.00 25	Center Edge	7T-4352 (2)*	4J-9208 (6)	2J-3507 (6)	5P-8250 (6)	
		1.38 35	Center Edge	4T-2862 (2)	1J-6762 (14)	2J-3506 (14)	5P-8248 (14)	
		1.38 35	Left End/Right End	7T-9125	4J-9058 (5)	2J-3507 (5)	5P-8250 (5)	
		1.77 45	Center Edge	7T-5701	4J-9058 (15)	2J-3507 (15)	5P-8250 (15)	
D9	Universal	1.38 35	Left End/Right End	9W-3927	4J-9058 (5)	2J-3507 (5)	5P-8250 (5)	
		1.77 45	Center Edge	9W-7044**	4J-9058 (15)	2J-3507 (15)	5P-8250 (15)	
		1.38 35	Left End/Right End	7T-9125	4J-9058 (5)	2J-3507 (5)	5P-8250 (5)	
		1.38 35	Center Edge	7T-9125	4J-9058 (5)	2J-3507 (5)	5P-8250 (5)	

Number in parentheses () after the part number indicates the quantity required.

** Extended Wear Life edge. Edge is wider and contains offset bolt holes. Use only Extended Wear Life end bits.

* Edges are 11" (280 mm) wide.

Ground Engaging Tools - Bulldozer Blades

MODEL	SERIAL NUMBER	BLADE MODEL	EDGE THICKNESS (in) (mm)	EDGE TYPE	EDGE PART NUMBER	BOLTS PER EDGE	NUTS PER EDGE	WASHERS PER EDGE	
D9 (cont)	1LP,1MH,2LP,5BH,7NH,2ZP,2B,9LH	Semi-U	1.38 35	Center Edge	7T-5702	4J-9058 (12)	2J-3507 (12)	5P-8250 (12)	
			1.77 45	Left End/Right End	9W-3927	4J-9058 (5)	2J-3507 (5)	5P-8250 (5)	
				Center Edge	9W-7043	4J-9058 (12)	2J-3507 (12)	5P-8250 (12)	
			1.38 35	Center Edge	9W-4500 (3)	4J-9058 (7)	2J-3507 (7)	5P-8250 (7)	
			1.57 40	Center Edge	7T-4342 (3)*	4J-9058 (7)	2J-3507 (7)	5P-8250 (7)	
			1.62 41	Center Edge	7J-2980 (3)	8J-2928 (7)	2J-3507 (7)	5P-8250 (7)	
		5A,18K,46K,61U,73R	Universal	1.38 35	Right /Left End Edge	9W-6092	4J-9058 (6)	2J-3507 (6)	5P-8250 (6)
					Right/Left Center Edge	9W-9197	4J-9058 (4)	2J-3507 (4)	5P-8250 (4)
					Center Edge	9W-6092	4J-9058 (6)	2J-3507 (6)	5P-8250 (6)
				1.57 40	Left End/Right End	7T-4341*	4J-9058 (6)	2J-3507 (6)	5P-8250 (6)
					Left Center Edge	7T-4336*	4J-9058 (4)	2J-3507 (4)	5P-8250 (4)
					Center Edge	7T-4341*	4J-9058 (6)	2J-3507 (6)	5P-8250 (6)
				Right Center Edge	7T-4337*	4J-9058 (4)	2J-3507 (4)	5P-8250 (4)	
1.62 41				Right/Left End Edge	7J-2959	4J-9208 (6)	2J-3507 (6)	5P-8250 (6)	
				Right/Left Center Edge	7J-2979	4J-9208 (4)	2J-3507 (4)	5P-8250 (4)	
				Center Edge	7J-2959	4J-9208 (6)	2J-3507 (6)	5P-8250 (6)	
1.38 35				Left End/Right End	9W-4502	1J-4948 (8)	2J-3507 (8)	5P-8250 (8)	
				18Y1-1875,42S,52Y	Semi-U	1.38 35	Center Edge	9W-4500	1J-4948 (7)
		Left End Edge	6Y-0311*			4J-9208 (8)	2J-3507 (8)	5P-8250 (8)	
		Center Edge	6Y-0310**			4J-9208 (7)	2J-3507 (7)	5P-8250 (7)	
		Right End Edge	6Y-0312*			4J-9208 (8)	2J-3507 (8)	5P-8250 (8)	
	1.62 41	Left End/Right End	9W-4508			4J-9208 (8)	2J-3507 (8)	5P-8250 (8)	
		Center Edge	7J-2980			4J-9208 (7)	2J-3507 (7)	5P-8250 (7)	
	1.77 45	Left End Edge	6Y-0477*			4J-9208 (8)	2J-3507 (8)	5P-8250 (8)	
		Center Edge	6Y-0476**			4J-9208 (7)	2J-3507 (7)	5P-8250 (7)	
		Right End Edge	6Y-0478*			4J-9208 (8)	2J-3507 (8)	5P-8250 (8)	
	1.38 35	Left End/Right end	7T-9779			6Y-8360 (5)	3K-9770 (5)	4K-0684 (5)	
		Center Edge	7T-9782 (2)			6Y-8360 (6)	3K-9770 (6)	4K-0684 (6)	
	1.77 45	Left End/Right end	9W-3930			5P-8823 (5)	3K-9770 (5)	4K-0684 (5)	
	18Y1876-Up	Semi-U		Center Edge	9W-3928 (2)	5P-8823 (6)	3K-9770 (6)	4K-0684 (6)	
			1.38 35	Left End/Right End	9W-4503	4J-9208 (6)	2J-3507 (6)	5P-8250 (6)	
				Center Edge	7T-9126 (2)	4J-9208 (9)	2J-3507 (9)	5P-8250 (9)	
			1.38 35	Left End/Right End	6Y-0315*	1J-4948 (6)	2J-3507 (6)	5P-8250 (6)	
				Center Edge	6Y-0313 (2)**	1J-4948 (9)	2J-3507 (9)	5P-8250 (9)	
				Right End Edge	6Y-0314*	1J-4948 (6)	2J-3507 (6)	5P-8250 (6)	

Number in parentheses () after the part number indicates the quantity required.
 ** Extended Wear Life edge. Edge is wider and contains offset bolt holes. Use only Extended Wear Life end bits.
 * Edges are 11" (280 mm) wide.

Ground Engaging Tools - Bulldozer Blades

MODEL	SERIAL NUMBER	BLADE MODEL	EDGE THICKNESS (in) (mm)	EDGE TYPE	EDGE PART NUMBER	BOLTS PER EDGE	NUTS PER EDGE	WASHERS PER EDGE
D9 (cont)	19Y1-1474,78S	Universal	1.62 41	Left End/Right End	9W-4506	1J-4948 (6)	2J-3507 (6)	5P-8250 (6)
			1.77 45	Center Edge	9W-4507 (2)	1J-4948 (9)	2J-3507 (9)	5P-8250 (9)
			1.38 35	Left End Edge	6Y-0481*	1J-4948 (6)	2J-3507 (6)	5P-8250 (6)
			1.77 45	Center Edge	6Y-0479 (2)**	1J-4948 (9)	2J-3507 (9)	5P-8250 (9)
			1.77 45	Left End/Right End	7T-9781	6V-8360 (5)	2J-3507 (5)	5P-8250 (5)
			1.77 45	Center Edge	9W-0775 (3)	6V-8360 (5)	2J-3507 (5)	5P-8250 (5)
	55C	Universal	1.77 45	Left End/Right end	9W-3929	5P-8823 (5)	3K-9770 (5)	4K-0684 (5)
			1.62 41	Center Edge	9W-3931 (3)	5P-8823 (5)	3K-9770 (5)	4K-0684 (5)
			1.62 41	Left End/Right End	7J-2964	4J-9058 (6)	2J-3507 (6)	5P-8250 (6)
			1.62 41	Center Edge	7J-2963	4J-9058 (13)	2J-3507 (13)	5P-8250 (13)
			1.77 45	Center Edge	7J-2962 (2)	4J-9208 (10)	2J-3507 (10)	5P-8250 (10)
			2.36 60	Left End/Right End	9W-6657	5P-8823 (5)	3K-9770 (5)	4K-0684 (5)
D10	21E832-Up,53C,89D	Semi-U	1.77 45	Center Edge	9W-6656 (2)	5P-8823 (6)	3K-9770 (6)	4K-0684 (6)
			1.77 45	Left End/Right End	8E-2086	5P-8823 (5)	3K-9770 (5)	4K-0684 (5)
			1.38 35	Center Edge	8E-2085 (2)	5P-8823 (6)	3K-9770 (6)	4K-0684 (6)
			1.77 45	Left End/Right End	9W-6608	5P-8823 (5)	3K-9770 (5)	4K-0684 (5)
			1.77 45	Center Edge	9W-6615 (3)	5P-8823 (5)	3K-9770 (5)	4K-0684 (5)
			2.36 60	Left End/right end	9W-6658 (3)	5P-8823 (5)	3K-9770 (5)	4K-0684 (5)
	79W	Semi-U	1.77 45	Center Edge	8E-2087 (3)	5P-8823 (5)	3K-9770 (5)	4K-0684 (5)
			1.77 45	Left End/Right end	6Y-0017	5P-8823 (9)	3K-9770 (9)	4K-0684 (9)
			2.36 60	Center Edge	6Y-0016 (2)	5P-8823 (9)	3K-9770 (9)	4K-0684 (9)
			1.38 35	Left End/Right End	6Y-0021	5P-8823 (9)	3K-9770 (9)	4K-0684 (9)
			1.57 40	Center Edge	6Y-0020 (2)	5P-8823 (9)	3K-9770 (9)	4K-0684 (9)
			1.77 45	Left End/Right End	1U-4457	5P-8823 (7)	3K-9770 (7)	4K-0684 (7)
80W	Universal	1.57 40	Center Edge	1U-4458 (3)	5P-8823 (9)	3K-9770 (9)	4K-0684 (9)	
		1.77 45	Left End/Right End	4T-0084	5P-8823 (7)	3K-9770 (7)	4K-0684 (7)	
		1.77 45	Center Edge	4T-0083 (3)	5P-8823 (9)	3K-9770 (9)	4K-0684 (9)	
		2.00 50	Left End/Right End	6Y-0019	5P-8823 (7)	3K-9770 (7)	4K-0684 (7)	
		2.36 60	Center Edge	6Y-0018 (3)	5P-8823 (9)	3K-9770 (9)	4K-0684 (9)	
		2.36 60	Left End/Right End	4T-0608	5P-8823 (7)	3K-9770 (7)	4K-0684 (7)	
					4T-0609 (3)	5P-8823 (9)	4K-0684 (9)	
					6Y-0022	5P-8823 (7)	4K-0684 (7)	

Number in parentheses () after the part number indicates the quantity required.
 ** Extended Wear Life edge. Edge is wider and contains offset bolt holes. Use only Extended Wear Life end bits.
 * Edges are 11" (280 mm) wide.

Ground Engaging Tools - Bulldozer Blades

MODEL	SERIAL NUMBER	BLADE MODEL	EDGE THICKNESS (in)	EDGE THICKNESS (mm)	EDGE TYPE	EDGE PART NUMBER	BOLTS PER EDGE	NUTS PER EDGE	WASHERS PER EDGE	
D10 (cont)	80W	Universal	2.36	60	Center Edge	6Y-0023 (3)	5P-8823 (9)	3K-9770 (9)	4K-0684 (9)	
	83W	Cushion	1.38	35	Right/Left End Edge	9J-3751	8J-2928 (10)	2J-3507 (10)	5P-8250 (10)	
			1.38	35	Left End/Right End	1U-4455	8J-2928 (9)	2J-3507 (9)	5P-8250 (9)	
	D11	1A,4BB,4KB,9NH	Semi-U	1.57	40	Center Edge	1U-4459 (2)	8J-2928 (9)	2J-3507 (9)	5P-8250 (9)
						Left End/Right end	4T-0082	8J-2928 (9)	2J-3507 (9)	5P-8250 (9)
				1.77	45	Center Edge	4T-0081 (2)	8J-2928 (9)	2J-3507 (9)	5P-8250 (9)
Left End/Right End						9W-2425	5P-8823 (9)	3K-9770 (9)	4K-0684 (9)	
D10 (cont)	83W	Cushion	2.36	60	Center Edge	9W-2426 (2)	5P-8823 (9)	3K-9770 (9)	4K-0684 (9)	
					Left End/Right end	9W-4494	5P-8823 (9)	3K-9770 (9)	4K-0684 (9)	
			1.77	45	Center Edge	9W-4495 (2)	5P-8823 (9)	3K-9770 (9)	4K-0684 (9)	
					Right/Left End Edge	9W-2425	5P-8823 (9)	3K-9770 (9)	4K-0684 (9)	
			2.36	60	Center Edge	9W-2424	5P-8823 (9)	3K-9770 (9)	4K-0684 (9)	
					Right/Left Center Edge	9W-2426	5P-8823 (9)	3K-9770 (9)	4K-0684 (9)	
D11	4CB,5TB,9MH,9ZH	Universal	1.77	45	Right/Left End Edge	9W-4494	5P-8823 (9)	3K-9770 (9)	4K-0684 (9)	
					Right/Left Center Edge	9W-4493	5P-8823 (9)	3K-9770 (9)	4K-0684 (9)	
D10 (cont)	83W	Cushion	2.36	60	Center Edge	9W-4495	5P-8823 (9)	3K-9770 (9)	4K-0684 (9)	
					Center Edge	9W-4495	5P-8823 (9)	3K-9770 (9)	4K-0684 (9)	

Number in parentheses () after the part number indicates the quantity required.
 ** Extended Wear Life edge. Edge is wider and contains offset bolt holes. Use only Extended Wear Life end bits.

* Edges are 11" (280 mm) wide.

Ground Engaging Tools - Bulldozer End Bits

Bulldozer End Bits

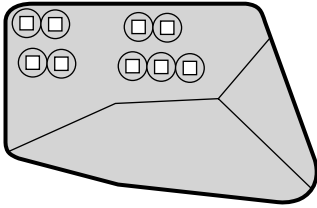

General Duty End Bits

- Provide a thicker wear area than the cutting edge.
- Made from DH-2 steel in the D3 through D6 sizes.
- Made from DH-3 steel in the D7 through D11 sizes.
- For use in most dozing applications.

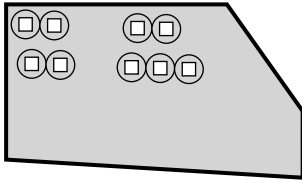

Utility End Bits

- Provides good corner protection in high impact, high abrasion materials.
- Made from through-hardened DH-2 steel.
- For use in applications where face wear is a problem.

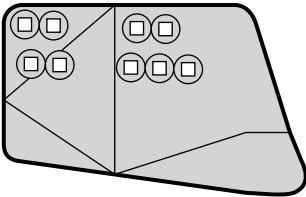

Extended Wear Life End Bits

- Provide an excellent cutting edge to end bit wear ratio in abrasive conditions.
- Provide a maximum depth of cut relative to the cutting edge.
- Provide a thicker wear area than the cutting edge.
- Made from DH-2 steel in the D4 through D6 sizes.
- Made from DH-3 steel in the D7 through D11 sizes.

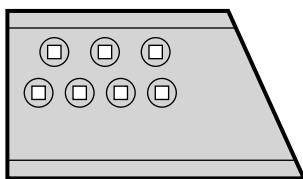

Finish Dozing End Bits

- Provide a depth of cut equal to the cutting edge.
- Protect the blade corner in low impact, low abrasion materials.
- Made from through-hardened DH-2 steel.
- For use in finish and semifinish dozing.

Ground Engaging Tools - Bulldozer End Bits

MODEL	SERIAL NUMBER	BLADE MODEL	THICKNESS (in) (mm)	GENERAL DUTY END BITS (lh) (rh)	UTILITY END BITS (lh) (rh)	EXTENDED WEAR LIFE END BITS (lh) (rh)	FINISH DOZING END BITS (lh) (rh)	BOLTS	NUTS	WASHERS
D3	5WH,6EH,85U	Power Angle & Tilt	0.62 16				4T-6229	3F-5108 (3)	4K-0367 (3)	5P-8247 (3)
	96X,8XP,8HP									
	8KP,2JP,9RH									
	1GP,8JP	Straight	0.62 16				4T-6229	3F-5108 (3)	4K-0367 (3)	5P-8247 (3)
	15W,31M,40V 86U,5LH									
D4	2A,4A,19J	Straight	0.75 19	9F-7074			4T-3052	3F-5108 (6)	4K-0367 (6)	5P-8247 (6)
	25F,27F,40D		0.88 22	3G-8322			4T-3052	3F-5108 (6)	4K-0367 (6)	5P-8247 (6)
	45J,67E,67F									
	84E,93C,94G									
	2TC,3CH,3DC 4HC	Straight	0.88 22			4T-5408	8E-9378	5J-4773 (4)	2J-3506 (4)	5P-8248 (4)
	2YH,4AC,4GH	Power Angle & Tilt	0.88 22				4T-6229	3F-5108 (3)	4K-0367 (3)	5P-8247 (3)
	6CH,6DH,8ZH		0.88 22				6Y-5840**	3F-5108 (3)	4K-0367 (3)	5P-8247 (3)
	9YH									
	5EC,5NH,5RH	Power Angle & Tilt	0.88 22			4T-5408	8E-9378	5J-4773 (4)	2J-3506 (4)	5P-8248 (4)
	6XH,9ZB,7CH 7EH									
D4 LGP	2A,4A,19J	Straight	0.75 19	9F-7074			4T-3052	3F-5108 (6)	4K-0367 (6)	5P-8247 (6)
	25F,27F,40D		0.88 22	3G-8322			4T-3052	3F-5108 (6)	4K-0367 (6)	5P-8247 (6)
	45J,67E,67F									
	84E,93C,94G									
	2TC,3CH,3DC 4HC	Straight	0.88 22			4T-5408	8E-9378	5J-4773 (4)	2J-3506 (4)	5P-8248 (4)
D5	2YH,4AC,4GH	Power Angle & Tilt	0.88 22				4T-6229	3F-5108 (3)	4K-0367 (3)	5P-8247 (3)
	6CH,6DH,8ZH		0.88 22				6Y-5840	3F-5108 (3)	4K-0367 (3)	5P-8247 (3)
	9SH,9TH,9YH									
	8MP,8YP,8LP									
	5EC,5RH,9ZB	Power Angle & Tilt	0.88 22			4T-5408	8E-9378	5J-4773 (4)	2J-3506 (4)	5P-8248 (4)
D5	2AH,2MH,7AH 6JP,4GP	Power Angle & Tilt				4T-5408	8E-9378	5J-4773 (4)	2J-3506 (4)	5P-8248 (4)
	2BH,4FH,4AH	Straight				4T-5408	8E-9378	5J-4773 (4)	2J-3506 (4)	5P-8248 (4)
	6MH,9WH,8GP	Power Angle & Tilt					8E-7078	5J-4771 (4)	2J-3506 (4)	5P-8248 (4)
	7BH	Semi-U				4T-5408	8E-9378	5J-4773 (4)	2J-3506 (4)	5P-8248 (4)
	10J,12J,16K	Straight	0.75 19	9F-7074			4T-3052	3F-5108 (6)	4K-0367 (6)	5P-8247 (6)

** Angled.

* Heavy Duty Mining end bit.

Number in parentheses () after the part number indicates the quantity required.

Ground Engaging Tools - Bulldozer End Bits

MODEL	SERIAL NUMBER	BLADE MODEL	THICKNESS (in) (mm)	GENERAL DUTY END BITS (lh) (rh)	UTILITY END BITS (lh) (rh)	EXTENDED WEAR LIFE END BITS (lh) (rh)	FINISH DOZING END BITS (lh) (rh)	BOLTS	NUTS	WASHERS
D5 (cont.)	10J,12J,16K 19R,90H,92H 97H	Straight	0.88 22	3G-8322 3G-8321			4T-3052 4T-3051	3F-5108 (6)	4K-0367 (6)	5P-8247 (6)
	1YH,2SH,4FP 1ZH,3KH	Power Angle & Tilt Straight				4T-5408 4T-5407 4T-5408 4T-5407	8E-9378 8E-9379 8E-9378 8E-9379	5J-4773 (4)	2J-3506 (4)	5P-8248 (4)
D6	6PH,9XH	Power Angle & Tilt	0.88 22				6Y-5840** 6Y-5839**	3F-5108 (3)	4K-0367 (3)	5P-8247 (3)
	1BH570-Up 3PP,4BP,1XP 3GP,1ZP,6HP	Angle	1.18 30 1.38 35	6Y-4410 6Y-4411 122-8617 122-8618		9W-1876 9W-1875	9W-8875 9W-8874	5J-4773 (6)	2J-3506 (6)	5P-8248 (6)
D5 LGP	1C,2G,3G 6C,9A	Straight	0.75 19 0.88 22	9F-7074 9F-7073 3G-8322 3G-8321			4T-3052 4T-3051	3F-5108 (6)	4K-0367 (6)	5P-8247 (6)
	15C1-5000,15E 16C1-5000,36D 38D,39H,85C							3F-5108 (6)	4K-0367 (6)	5P-8247 (6)
	1CH,2NH,4PH	Semi-U	1.18 30 1.38 35	6Y-4410 6Y-4411	122-8617 122-8618	9W-1876 9W-1875	9W-8875 9W-8874	5J-4773 (6)	2J-3506 (6)	5P-8248 (6)
	1DH1-599 2HH,3JH,4BH	Straight				4T-4454 4T-4455	4T-4436 4T-4435	5J-4773 (6)	2J-3506 (6)	5P-8248 (6)
	1DH600-Up 1RP,3EP	Straight	1.18 30 1.38 35	6Y-4410 6Y-4411	122-8617 122-8618	9W-1876 9W-1875	9W-8875 9W-8874	5J-4773 (6)	2J-3506 (6)	5P-8248 (6)
	3EH,4DH,4LH 1BH1-569	Angle				4T-4454 4T-4455	4T-4436 4T-4435	5J-4773 (6)	2J-3506 (6)	5P-8248 (6)
	3F,4F,8E	Angle	0.88 22	3G-8296 3G-8295			4T-3050 4T-3049	3F-5108 (6)	4K-0367 (6)	5P-8247 (6)
	9E,15C5001-Up 16C5001-Up 16E,37D,39D 40H,81D,82D		0.88 22	9F-7076 9F-7075				3F-5108 (6)	4K-0367 (6)	5P-8247 (6)
	17H,21H,46G 55G,63S,95E	Straight	0.88 22	5J-1420 5J-1419			4T-3046 4T-3045	4F-7827 (6)	2J-3506 (6)	5P-8248 (6)
	18H,44E,47G 54U,58G	Angle	0.88 22 1.00 25	3G-8298 3G-8297 8E-9900 8E-9901				4T-3042 4T-3041	4F-7827 (6)	2J-3506 (6)
D6 LGP	1AH,2LH,3FH 1SP,3HP	Straight	1.00 25			4T-4454 4T-4455	4T-4436 4T-4435	4F-7827 (6)	2J-3506 (6)	5P-8248 (6)
D7	2E,5A 17C1-5000,17E 34D,83D,84C	Straight	1.38 35				4T-6672 4T-6671	5J-4771 (7)	2J-3506 (7)	5P-8248 (7)

Number in parentheses () after the part number indicates the quantity required. * Heavy Duty Mining end bit. ** Angled.

Ground Engaging Tools - Bulldozer End Bits

MODEL	SERIAL NUMBER	BLADE MODEL	THICKNESS (in)	THICKNESS (mm)	GENERAL DUTY END BITS (lh)	GENERAL DUTY END BITS (rh)	UTILITY END BITS (lh)	UTILITY END BITS (rh)	EXTENDED WEAR LIFE END BITS (lh)	EXTENDED WEAR LIFE END BITS (rh)	FINISH DOZING END BITS (lh)	FINISH DOZING END BITS (rh)	BOLTS	NUTS	WASHERS			
D7 (cont.)	4DB,1JP,8LH 2FC,2JH	Universal	1.38	35	9W-6198	9W-6199					4T-6506	4T-6505	6F-0196 (7)	2J-3505 (7)	5P-8249 (7)			
			1.00	25	3G-8316	3G-8315					4T-6506	4T-6505	5J-2409 (7)	2J-3505 (7)	5P-8249 (7)			
			1.12	28	4J-8844	4J-8843								5J-2409 (7)	2J-3505 (7)	5P-8249 (7)		
		3CC,4ZC	Angle	1.38	35	9W-6198	9W-6199							5J-2409 (7)	2J-3505 (7)	5P-8249 (7)		
				1.38	35			105-0574	105-0575					5J-2409 (7)	2J-3505 (7)	5P-8249 (7)		
				1.75	45			105-0576	105-0577					5J-2409 (7)	2J-3505 (7)	5P-8249 (7)		
		5SB,42G,61K 85D,9AR,8MH 7AC,9JB	Universal	1.00	25	3G-8316	3G-8315					4T-6506	4T-6505	6F-0196 (7)	2J-3505 (7)	5P-8249 (7)		
				1.00	25										6F-0196 (7)	2J-3505 (7)	5P-8249 (7)	
				1.38	35			105-0574	105-0575						6F-0196 (7)	2J-3505 (7)	5P-8249 (7)	
		6A,6E 17C5001-Up,18E 35D,84D	Angle	1.75	45			105-0576	105-0577					6F-0196 (7)	2J-3505 (7)	5P-8249 (7)		
				0.88	22	3J-2466	3J-2465							4T-6668	4T-6667	5J-4771 (4)	2J-3506 (4)	5P-8248 (4)
				1.12	28	3J-2466	3J-2465								1J-6761 (3)	2J-3506 (3)	5P-8248 (3)	
	D7 LGP	6KB,14H,8ZB 23F,31F,49K 53J,59F,60K 64K,4XC,8NH	Straight	1.00	25	3G-8316	3G-8315					4T-6506	4T-6505	6F-0196 (7)	2J-3505 (7)	5P-8249 (7)		
				1.12	28	4J-8844	4J-8843					4T-6506	4T-6505	6F-0196 (7)	2J-3505 (7)	5P-8249 (7)		
				1.37	35			105-0574	105-0575						6F-0196 (7)	2J-3505 (7)	5P-8249 (7)	
		42G,61K,85D	Universal	1.38	35	9W-6198	9W-6199							6F-0196 (7)	2J-3505 (7)	5P-8249 (7)		
				1.75	45			105-0576	105-0577						6F-0196 (7)	2J-3505 (7)	5P-8249 (7)	
				0.88	22	3G-8294	3G-8293								6F-0196 (7)	2J-3505 (7)	5P-8249 (7)	
		6JB,4FG,3GH 2RP,8RH,5SP 9KP	Straight	1.75	45			105-0576	105-0577					6F-0196 (7)	2J-3505 (7)	5P-8249 (7)		
				1.12	28	4J-8844	4J-8843							4T-6506	4T-6505	6F-0196 (7)	2J-3505 (7)	5P-8249 (7)
D8		1HH,2XP,6NH 9AH,4ZP	Angle	1.57	40	8E-4194	8E-4193			8E-4538	8E-4537	6Y-4278	6Y-4277	4J-9058 (7)	2J-3507 (7)	5P-8250 (7)		
				1.97	50			100-3140	100-3139					4J-9058 (7)	2J-3507 (7)	5P-8250 (7)		
			1JH,6AH,2WP 9CH	Universal	1.06	27	8E-4194	8E-4193			8E-4538	8E-4537	6Y-4278	6Y-4277	4J-9058 (7)	2J-3507 (7)	5P-8250 (7)	
					1.97	50			100-3140	100-3139					4J-9058 (7)	2J-3507 (7)	5P-8250 (7)	
			1KH,2PP,3MP 2TP,9BH,2NP 1HP,6LH,9PH 3WH	Semi-U	1.58	40	8E-4194	8E-4193			8E-4538	8E-4537	6Y-4278	6Y-4277	4J-9058 (7)	2J-3507 (7)	5P-8250 (7)	
					1.97	50			100-3140	100-3139					4J-9058 (7)	2J-3507 (7)	5P-8250 (7)	
	3E,8A,12C 18C,32D,44C 73D,86D	Semi-U	1.00	25							4T-6672	4T-6671	1J-6761 (7)	2J-3506 (7)	5P-8248 (7)			

Number in parentheses () after the part number indicates the quantity required. * Heavy Duty Mining end bit. ** Angled.

Ground Engaging Tools - Bulldozer End Bits

MODEL	SERIAL NUMBER	BLADE MODEL	THICKNESS (in) (mm)	GENERAL DUTY END BITS (lh) (rh)	UTILITY END BITS (lh) (rh)	EXTENDED WEAR LIFE END BITS (lh) (rh)	FINISH DOZING END BITS (lh) (rh)	BOLTS	NUTS	WASHERS		
D8 (cont.)	4Y1-1939	Semi-U	1.12 28	9J-1478 9J-1477		7T-4090 7T-4091	4T-6240 4T-6239	4J-9208 (7)	2J-3507 (7)	5P-8250 (7)		
			1.18 30	3G-8318 3G-8317			4T-8090	4T-8089	4J-9208 (7)	2J-3507 (7)	5P-8250 (7)	
			1.58 40	3G-8288 3G-8287					4J-9208 (7)	2J-3507 (7)	5P-8250 (7)	
	4Y1940-Up	Semi-U	1.97 50	9W-8654 9W-8653					4J-9208 (7)	2J-3507 (7)	5P-8250 (7)	
			1.38 35	3G-8292 3G-8291		8E-4540 8E-4539			4J-9208 (7)	2J-3507 (7)	5P-8250 (7)	
			1.58 40	3G-8284 3G-8283	100-3136 100-3135				4J-9208 (7)	2J-3507 (7)	5P-8250 (7)	
	5Y,27B,41Z	Angle	1.75 45		100-3136 100-3135				4J-9208 (7)	2J-3507 (7)	5P-8250 (7)	
			1.97 50	8E-4196 8E-4197					4J-9208 (7)	2J-3507 (7)	5P-8250 (7)	
			2.36 60		100-3138 100-3137				4J-9208 (7)	2J-3507 (7)	5P-8250 (7)	
	6Y1-1395 30V,34W,65X 69V	Universal	1.12 28	9J-1478 9J-1477		7T-4090 7T-4091	4T-6240 4T-6239	4T-6240 4T-6239	4J-9058 (7)	2J-3507 (7)	5P-8250 (7)	
			1.18 30	3G-8318 3G-8317				4T-8090	4T-8089	4J-9058 (7)	2J-3507 (7)	
			1.58 40	3G-8288 3G-8287					4J-9058 (7)	2J-3507 (7)	5P-8250 (7)	
6Y1396-Up 82M,42Z		Universal	1.97 50	9W-8654 9W-8653					4J-9058 (7)	2J-3507 (7)	5P-8250 (7)	
			1.58 40	3G-8288 3G-8287		7T-4090 7T-4091	4T-6240 4T-6239	4T-6240 4T-6239	4J-9058 (7)	2J-3507 (7)	5P-8250 (7)	
			1.97 50	9W-8654 9W-8653				4T-8090	4T-8089	4J-9058 (7)	2J-3507 (7)	
11C,74D,88D		Universal	1.38 35	3G-8292 3G-8291		8E-4540 8E-4539			4J-9058 (7)	2J-3507 (7)	5P-8250 (7)	
			1.58 40	3G-8284 3G-8283					4J-9058 (7)	2J-3507 (7)	5P-8250 (7)	
			1.75 45		100-3136 100-3135				4J-9058 (7)	2J-3507 (7)	5P-8250 (7)	
14J,29E,44K 47K,69E,78C 94E		Semi-U	1.97 50	8E-4196 8E-4197					4J-9058 (7)	2J-3507 (7)	5P-8250 (7)	
			2.36 60		100-3138 100-3137				4J-9058 (7)	2J-3507 (7)	5P-8250 (7)	
			1.12 28	3J-2466 3J-2465				4T-6506	4T-6505	5J-2409 (7)	2J-3505 (7)	5P-8249 (7)
	20F,24E,29J 30E,45K,48K 73E	Universal	1.12 28	3G-8314 3G-8314					5J-2409 (7)	2J-3505 (7)	5P-8249 (7)	
			1.12 28	4J-8850 4J-8849					4J-9058 (7)	2J-3507 (7)	5P-8250 (7)	
			1.12 28	3G-8300 3G-8299					4J-9058 (7)	2J-3507 (7)	5P-8250 (7)	
	29V,30W,60V 68V	Semi-U	1.58 40	3G-8278 3G-8277					4J-9058 (7)	2J-3507 (7)	5P-8250 (7)	
			1.12 28	4J-8844 4J-8843				4T-6506	4T-6505	5J-2409 (7)	2J-3505 (7)	
			1.12 28	3G-8316 3G-8315					5J-2409 (7)	2J-3505 (7)	5P-8249 (7)	
	D9	11H,1MP,2ZH 7PH	Universal	1.58 40	3G-8286 3G-8285				5J-2409 (7)	2J-3505 (7)	5P-8249 (7)	
				1.12 28	9J-1480 9J-1479		7T-4088 7T-4089			5J-2409 (7)	2J-3505 (7)	5P-8249 (7)
				1.12 28	3G-8302 3G-8301					5J-2409 (7)	2J-3505 (7)	5P-8249 (7)
D9	11H,1MP,2ZH 7PH	Universal	1.58 40	3G-8280 3G-8279				4J-9058 (7)	2J-3507 (7)	5P-8250 (7)		
			1.97 50	9W-8652 9W-8651					4J-9058 (7)	2J-3507 (7)	5P-8250 (7)	
			1.75 45		100-3136 100-3135				4J-9058 (7)	2J-3507 (7)	5P-8250 (7)	
D9	11H,1MP,2ZH 7PH	Universal	1.97 50	8E-4196 8E-4197		8E-4540 8E-4539	6Y-4278 6Y-4277	4J-9058 (7)	2J-3507 (7)	5P-8250 (7)		
			1.97 50						4J-9058 (7)	2J-3507 (7)	5P-8250 (7)	
			2.36 60		100-3138 100-3137				4J-9058 (7)	2J-3507 (7)	5P-8250 (7)	

** Angled.

* Heavy Duty Mining end bit.

Number in parentheses () after the part number indicates the quantity required.

Ground Engaging Tools - Bulldozer End Bits

MODEL	SERIAL NUMBER	BLADE MODEL	THICKNESS (in)	THICKNESS (mm)	GENERAL DUTY END BITS (lh)	GENERAL DUTY END BITS (rh)	UTILITY END BITS (lh)	UTILITY END BITS (rh)	EXTENDED WEAR LIFE END BITS (lh)	EXTENDED WEAR END BITS (rh)	FINISH DOZING END BITS (lh)	FINISH DOZING END BITS (rh)	BOLTS	NUTS	WASHERS			
D9 (cont.)	1MH,5BH,2BP 2ZP,1LP,2LP 7NH,9LH	Semi-U	1.75	45	8E-4196	8E-4197	100-3136	100-3135	8E-4540	8E-4539	6Y-4278	6Y-4277	4J-9058 (7)	2J-3507 (7)	5P-8250 (7)			
			1.97	50										4J-9058 (7)	2J-3507 (7)	5P-8250 (7)		
			1.97	50					100-3138	100-3137					4J-9058 (7)	2J-3507 (7)	5P-8250 (7)	
	4K,5A,18K 21E,25E,53C 61U,73R,89D	Semi-U	1.25	32	5J-1280	5J-1279			7T-4092	7T-4093				8J-2928 (7)	2J-3507 (7)	5P-8250 (7)		
			1.38	35	3G-8290	3G-8289									8J-2928 (7)	2J-3507 (7)	5P-8250 (7)	
			1.58	40	3G-8282	3G-8281									8J-2928 (7)	2J-3507 (7)	5P-8250 (7)	
	14C,19K,20H 55C,78X	Universal	1.97	50	9W-9194	9W-9193								8J-2928 (7)	2J-3507 (7)	5P-8250 (7)		
			1.25	32	4J-8724	4J-8723			7T-4094	7T-4095					8J-2928 (7)	2J-3507 (7)	5P-8250 (7)	
			1.38	35	3G-8292	3G-8291									8J-2928 (7)	2J-3507 (7)	5P-8250 (7)	
	18Y,42S,52Y	Semi-U	1.58	40	3G-8284	3G-8283								8J-2928 (7)	2J-3507 (7)	5P-8250 (7)		
			1.97	50	8E-4196	8E-4197									8J-2928 (7)	2J-3507 (7)	5P-8250 (7)	
			1.58	40	1U-1546	1U-1545			8E-4542	8E-4541			3G-7764	3G-7763	6V-8360 (7)	3K-9770 (7)	4K-0684 (7)	
	D10	19Y,78S	Universal	1.75	45			100-3132	100-3131						6V-8360 (7)	3K-9770 (7)	4K-0684 (7)	
				2.16	55	8E-4198	8E-4199									6V-8360 (7)	3K-9770 (7)	4K-0684 (7)
				2.36	60			100-3134	100-3133							6V-8360 (7)	3K-9770 (7)	4K-0684 (7)
1RH,1SH,4LP 6FP		Universal	2.38	60	7T-4688	7T-4689								6V-8360 (7)	3K-9770 (7)	4K-0684 (7)		
			1.58	40	1U-1546	1U-1545					8E-4542	8E-4541	3G-7764	3G-7763	6V-8360 (7)	3K-9770 (7)	4K-0684 (7)	
			1.75	45			100-3132	100-3131							6V-8360 (7)	3K-9770 (7)	4K-0684 (7)	
1RH,4KP,6EP 7RH		Semi-U	2.16	55	8E-4198	8E-4199								6V-8360 (7)	3K-9770 (7)	4K-0684 (7)		
			2.36	60			100-3134	100-3133							6V-8360 (7)	3K-9770 (7)	4K-0684 (7)	
			2.38	60	7T-4688	7T-4689									6V-8360 (7)	3K-9770 (7)	4K-0684 (7)	
1RH,4KP,6EP 7RH		Semi-U	1.75	45	8E-4198	8E-4199			100-3132	100-3131	8E-4542	8E-4541		5P-8823 (7)	3K-9770 (7)	4K-0684 (7)		
			2.36	60			100-3134	100-3133						5P-8823 (7)	3K-9770 (7)	4K-0684 (7)		
			1.75	45	8E-4198	8E-4199			100-3132	100-3131	8E-4542	8E-4541		5P-8823 (7)	3K-9770 (7)	4K-0684 (7)		
1SH,4LP,6EP 7WH		Universal	4.72	120	107-3516*	107-3515*								5P-8823 (9)	3K-9770 (9)	4K-0684 (9)		
			4.72	120	113-0338*	113-0338*									5P-8823 (9)	3K-9770 (9)	4K-0684 (9)	
			2.36	60	8E-4544	8E-4543	8E-9786	8E-9785	8E-4546	8E-4545					5P-8823 (9)	3K-9770 (9)	4K-0684 (9)	
79W,80W	Semi-U	2.95	75			8E-9748	8E-9749						5P-8361 (9)	3K-9770 (9)	4K-0684 (9)			
		2.36	60	8E-4544	8E-4543	8E-9786	8E-9785	8E-4546	8E-4545					5P-8361 (9)	3K-9770 (9)	4K-0684 (9)		
		2.95	75			8E-9748	8E-9749							5P-8361 (9)	3K-9770 (9)	4K-0684 (9)		

** Angled.

* Heavy Duty Mining end bit.

Number in parentheses () after the part number indicates the quantity required.

Ground Engaging Tools - Bulldozer End Bits

MODEL	SERIAL NUMBER	BLADE MODEL	THICKNESS (in) (mm)	GENERAL DUTY END BITS (lh) (rh)	UTILITY END BITS (lh) (rh)	EXTENDED WEAR LIFE END BITS (lh) (rh)	FINISH DOZING END BITS (lh) (rh)	BOLTS	NUTS	WASHERS
D11	4BB,4CB,4KB 5TB	Semi-U	2.36 60	8E-4544 8E-4543	8E-9786 8E-9785	8E-4546 8E-4545		5P-8823 (9)	3K-9770 (9)	4K-0684 (9)
			2.95 75	8E-4544 8E-4543	8E-9748 8E-9749		5P-8823 (9)	3K-9770 (9)	4K-0684 (9)	
			4.72 120	107-3522* 107-3521*			5P-8823 (9)	3K-9770 (9)	4K-0684 (9)	
	4BB,4CB,4KB	Universal	2.36 60	8E-4544 8E-4543	8E-9786 8E-9785	8E-4546 8E-4545		5P-8823 (9)	3K-9770 (9)	4K-0684 (9)
			2.95 75	8E-4544 8E-4543	8E-9748 8E-9749		5P-8823 (9)	3K-9770 (9)	4K-0684 (9)	
			4.72 120	109-9047* 109-9047*			5P-8823 (9)	3K-9770 (9)	4K-0684 (9)	

Number in parentheses () after the part number indicates the quantity required.

* Heavy Duty Mining end bit.

** Angled.

Ground Engaging Tools - Bulldozer Wear Bars and Plates

Bulldozer Wear Bars

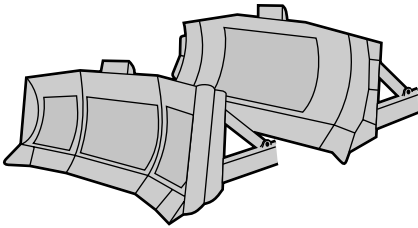

- Offer additional wear resistance and strength to the dozer blade in high wear/high impact applications.
- Made of DH-2 through-hardened alloy steel.
- For use over the blade liner or wear plate on a dozer blade.

ITEM	LENGTH		PART NUMBER
	(ft)	(m)	
Wear Bar	8.0	2.438	107-3386
Wear Bar	9.0	2.743	107-3387
Wear Bar	11.0	3.353	107-3388
Wear Bar	12.0	3.658	107-3389
Wear Bar	13.0	3.962	107-3390
Wear Bar	15.0	4.572	107-3391

Bulldozer Plates

Reinforcing Wear Plates:

- Provide extended blade life in highly abrasive or extreme impact conditions.
- Provide a repair or resurface option for worn or damaged moldboards.
- Are formed to fit the curve of the blade so that they are easily installed.

Pusher Plates:

- Are made of heat treated steel.
- Are formed to fit the curve of the blade so that they are easily installed.
- For use on bulldozer blades that are used to push loading scrapers.

Ground Engaging Tools - Bulldozer Wear Plates

MODEL	SERIAL NUMBER	BLADE MODEL	ITEM	PLATE HEIGHT (in)	PLATE HEIGHT (mm)	PLATE WIDTH (in)	PLATE WIDTH (mm)	PLATE THICKNESS (in)	PLATE THICKNESS (mm)	REINFORCING WEAR PLATE
D3	85U8376-Up	Power Angle & Tilt	Wear Plate					0.31	8	3J-3117
			Wear Plate					0.31	8	3J-3116 (2)
D3 LGP	85U1-8375	Power Angle & Tilt	Wear Plate					0.31	8	1J-3108 (5)
			Wear Plate					0.31	8	3J-3114 (3)
D4	2A,25F,67F	Straight	Wear Plate					0.31	8	3J-3114 (2)
			Wear Plate					0.31	8	3J-3116 (2)
	5F,12D,24F,65F,78D,97E	Angle	Wear Plate					0.31	8	3J-3116 (4)
			Wear Plate					0.31	8	3J-3116 (4)
	9ZB	Power Angle & Tilt	Wear Plate					0.31	8	3J-3116 (4)
			Wear Plate					0.31	8	3J-3116 (4)
	10D,52E,79D,96E	Angle	Wear Plate	37.0	940	27.6	702	0.31	8	3J-3115
			Wear Plate	51.3	1302	21.5	546	0.31	8	3J-3117
D5	2AH	Power Angle & Tilt	Wear Plate					0.38	10	3J-3740 (5)
			Wear Plate					0.38	10	2J-8526 (4)
	2BH	Straight	Wear Plate					0.38	10	2J-8526 (4)
			Wear Plate					0.38	10	1J-3108 (6)
	10J,12J,19R,92H,97H	Straight	Wear Plate					0.38	10	1J-3106 (6)
			Wear Plate					0.38	10	1J-3106 (6)
	11J,13J,93H,98H	Angle	Wear Plate					0.38	10	1J-3106 (6)
			Wear Plate					0.38	10	1J-3106 (6)
	42K,91H,96H	Angle	Wear Plate					0.38	10	1J-3106 (5)
			Wear Plate					0.38	10	1J-3106 (5)
	90H	Straight	Wear Plate					0.38	10	1J-3108 (5)
			Wear Plate					0.38	10	1J-3108 (5)
D6	1AH,2LH,3FH	Semi-U	Wear Plate	31.0	787	33.6	854	0.38	10	2J-8526 (4)
			Wear Plate	24.0	610	24.0	610	0.38	10	3J-3740 (6)
	3F,4F,16E,40H	Angle	Wear Plate					0.38	10	1J-3106 (5)
			Wear Plate					0.38	10	1J-3108 (5)
	18H,44E,47G	Straight	Wear Plate					0.38	10	2J-8526 (4)
			Wear Plate					0.38	10	2J-8526 (4)
	21H,95E	Straight	Wear Plate					0.38	10	2J-8526 (4)
			Wear Plate					0.38	10	2J-8526 (5)
D6 LGP	1AH,2LH,3FH	Straight	Wear Plate	31.0	787	33.6	854	0.38	10	2J-8526 (5)
D7	All	Angle	Wear Plate					0.31	8	3J-3141 (3)
			Pusher Plate					0.63	16	4J-3699
	Semi-U	Straight	Wear Plate	42.4	1077	42.4	1076	0.31	8	3J-3142 (3)
			Pusher Plate					0.63	16	4J-3699
	Straight	Universal	Wear Plate	41.5	1054	41.5	1054	0.31	8	3J-3142 (4)
			Pusher Plate	42.4	1077	42.4	1076	0.31	8	3J-3142 (4)
	Universal	Universal	Wear Plate	41.5	1054	41.5	1054	0.63	16	4J-3699
			Pusher Plate					0.63	16	4J-3699
D8	1JH	Universal	Left End Wear Plate					0.63	16	6Y-7246
			Center Wear Plate					0.63	16	6Y-7244
	1KH	Semi-U	Right End Wear Plate					0.63	16	6Y-7245
			Left End Wear Plate					0.63	16	9W-2760
	Semi-U	Straight	Left End Wear Plate					0.63	16	9W-2760
			Left End Wear Plate					0.63	16	9W-2760
	Straight	Universal	Left Center Wear Plate					0.63	16	9W-2759
			Center Wear Plate					0.63	16	9W-2756
	Straight	Universal	Center Wear Plate					0.63	16	9W-2756
			Right Center Wear Plate					0.63	16	9W-1771
	Straight	Universal	Right Center Wear Plate					0.63	16	9W-2758
			Right End Wear Plate					0.63	16	9W-2757

Number in parentheses () after the part number indicates the quantity required.

Ground Engaging Tools - Bulldozer Wear Plates

MODEL	SERIAL NUMBER	BLADE MODEL	ITEM	PLATE HEIGHT (in)	PLATE HEIGHT (mm)	PLATE WIDTH (in)	PLATE WIDTH (mm)	PLATE THICKNESS (in)	PLATE THICKNESS (mm)	REINFORCING WEAR PLATE	
D8 (cont.)	1KH	Semi-U	Right End Pusher Plate					0.63	16	9W-2757	
			Pusher Plate					0.63	16	9W-2756	
	1LH,2ZH	Angle	Wear Plate					0.40	10	2J-8526 (5)	
			Wear Plate					0.50	13	1U-4417 (5)	
	4Y1-1489	Semi-U	Pusher Plate					0.63	16	6J-9248	
			Left Center Wear Plate					0.63	16	9T-0252	
	4Y1490-Up	Semi-U	Left Center Wear Plate					0.63	16	9T-0250	
			Center Wear Plate					0.63	16	4T-9592	
				Right End Wear Plate					0.63	16	9T-0249
				Right Center Pusher Plate					0.63	16	9T-0251
	6Y1-1395	Universal	Wear Plate					0.50	13	1U-4417 (6)	
			Left End Wear Plate					0.63	16	9T-0254	
	6Y1396-Up	Universal	Left Center Wear Plate					0.63	16	9T-0256	
			Right Center Wear Plate					0.63	16	9T-0255	
			Right End Wear Plate					0.63	16	9T-0253	
			Center Pusher Plate					0.63	16	4T-9592	
20F,45K,48K	Universal	Wear Plate					0.50	13	6J-9286 (4)		
		Wear Plate					0.50	13	9J-1659 (5)		
29V,30W	Semi-U	Wear Plate					0.50	13	4J-4205 (4)		
		Left End Wear Plate					0.50	13	9J-7540		
30E,73E	Universal	Right End Wear Plate					0.50	13	9J-7539		
		Wear Plate					0.50	13	9J-1659 (4)		
30V	Universal	Pusher Plate					0.63	16	9J-6870		
		Wear Plate					0.50	13	4J-4205 (4)		
43K	Semi-U	Pusher Plate					0.63	16	9J-6870		
		Wear Plate					0.50	13	4J-4205 (4)		
60V,68V	Semi-U	Pusher Plate					0.63	16	9J-6870		
		Wear Plate					0.50	13	6J-9286 (4)		
69E,80V,95S	Semi-U	Wear Plate					0.50	13	6J-9286 (4)		
		Left End Wear Plate					0.63	16	6Y-6911		
1LH,2ZH	Universal	Center Wear Plate					0.63	16	6Y-6910		
		Right End Wear Plate					0.63	16	6Y-6912		
1MH,5BH	Semi-U	Left End Wear Plate					0.63	16	9T-0250		
		Left Center Wear Plate					0.63	16	9T-0252		
			Center Wear Plate				0.63	16	7T-5803		
			Center Wear Plate				0.63	16	6Y-1255		
			Right Center Wear Plate				0.63	16	9T-0251		
			Right End Wear Plate				0.63	16	9T-0249		
			Right End Wear Plate				0.63	16	9T-0249		
			Pusher Plate				0.63	16	7T-5803		

Number in parentheses () after the part number indicates the quantity required.

Ground Engaging Tools - Bulldozer Wear Plates

MODEL	SERIAL NUMBER	BLADE MODEL	ITEM	PLATE HEIGHT (in)	PLATE HEIGHT (mm)	PLATE WIDTH (in)	PLATE WIDTH (mm)	PLATE THICKNESS (in)	PLATE THICKNESS (mm)	REINFORCING WEAR PLATE
D9 (cont.)	All	Universal	Wear Plate					0.50	13	6J-9269 (4)
			Center Wear Plate					0.63	16	6J-9248
		Wear Plate						0.50	13	6J-9249 (4)
		Wear Plate						0.50	13	3J-3380 (5)
		Right End Wear Plate					0.63	16	4T-3730	
		Left End Wear Plate					0.63	16	9W-1261	
		Left Center Wear Plate					0.63	16	9W-1260	
		Center Wear Plate					0.63	16	9W-0810	
		Right Center Wear Plate					0.63	16	9W-1259	
		Right End Wear Plate					0.63	16	9W-1258	
	18Y1-1875 18Y1876-Up	Universal	Left End Wear Plate					0.63	16	4T-3735
			Left Center Wear Plate					0.63	16	4T-3737
		Center Wear Plate						0.63	16	1U-0902
		Right Center Wear Plate					0.63	16	4T-3736	
		Right End Wear Plate					0.63	16	4T-3734	
		Universal	Left End Wear Plate					0.63	16	9W-0808
			Left Center Wear Plate					0.63	16	9W-0811
		Center Wear Plate					0.63	16	9W-0810	
		Right Center Wear Plate					0.63	16	9W-0809	
		Right End Wear Plate					0.63	16	9W-0812	
Semi-U	Wear Plate					0.50	13	2J-8523 (4)		
	Wear Plate					0.50	13	6J-9249 (4)		
52Y	Semi-U	Pusher Plate					0.63	16	6J-9248	
		Left End Wear Plate					0.63	16	4T-3731	
	Right Center Wear Plate					0.63	16	4T-3732		
	Left Center Pusher Plate					0.63	16	4T-3733		
	Center Pusher Plate					0.63	16	1U-0902		
	Universal	Left End Wear Plate					0.63	16	9W-7265	
		Left Center Wear Plate					0.63	16	9W-7264	
	Center Wear Plate					0.63	16	9W-2409		
	Center Wear Plate					0.63	16	6Y-1080		
	Right Center Wear Plate					0.63	16	9W-7262		
Semi-U	Right End Wear Plate					0.63	16	9W-7263		
	Wear Plate			78.9	2005	28.0	710	0.50	13	3G-6344 (8)
79W1-536	Semi-U	Pusher Plate				60.0	1524	0.63	16	3G-6343
		Left End Wear Plate					0.63	16	4T-3723	
79W537-Up	Semi-U	Left End Wear Plate						0.63	16	9W-1261
		Left End Wear Plate					0.63	16	9W-1261	

Number in parentheses () after the part number indicates the quantity required.

Ground Engaging Tools - Bulldozer Wear Plates

MODEL	SERIAL NUMBER	BLADE MODEL	ITEM	PLATE HEIGHT		PLATE WIDTH		PLATE THICKNESS		REINFORCING WEAR PLATE
				(in)	(mm)	(in)	(mm)	(in)	(mm)	
D10 (cont.)	79W537-Up	Semi-U	Left End Wear Plate					0.63	16	9W-1261
			Left Center Wear Plate					0.63	16	4T-3724
			Left Center Wear Plate					0.63	16	9W-7261
			Center Wear Plate					0.63	16	9W-2409
			Center Wear Plate					0.63	16	6Y-1011
			Right Center Wear Plate	61.8	1570	42.3	1074	0.63	16	4T-3725
			Right Center Wear Plate					0.63	16	9W-7260
			Right End Wear Plate	56.3	1430	20.6	524	0.63	16	4T-3722
			Right End Wear Plate					0.63	16	9W-1258
			Right End Wear Plate					0.63	16	9W-1258
			Center Pusher Plate	75.0	1905	78.7	2000	16.00	1	1U-3697
			Pusher Plate					0.63	16	9W-2409
			Wear Plate			28.0	710	0.50	13	3G-6344 (9)
			Left End Wear Plate					0.63	16	4T-3727
			D11	83W 48B,4KB	Universal	Left End Wear Plate				
Left Center Wear Plate								0.63	16	1U-3697
Center Wear Plate								0.63	16	4T-3729
Right Center Wear Plate								0.63	16	4T-3726
Right End Wear Plate								0.63	16	9J-4567
Pusher Plate	36.3	922				74.8	1900	0.80	20	4T-8144
Left End Wear Plate								0.63	16	4T-8144
Left End Wear Plate								0.63	16	4T-8144
Left Center Wear Plate								0.63	16	4T-8146
Center Wear Plate	78.5	1994				80.7	2050	0.63	16	4T-5308
Center Wear Plate								0.63	16	6Y-1100
Right Center Wear Plate	70.2	1783				48.0	1220	0.63	16	4T-8145
Right End Wear Plate								0.63	16	4T-8143
Pusher Plate								0.63	16	4T-5308
Left End Wear Plate								0.63	16	4T-7630
Left End Wear Plate					0.63	16	4T-7630			
Left Center Wear Plate					0.63	16	4T-7631			
Center Wear Plate	78.5	1994	80.7	2050	0.63	16	4T-5308			
Center Wear Plate					0.63	16	6Y-1319			
Right Center Wear Plate	70.2	1783	27.3	693	0.63	16	4T-7632			
Right End Wear Plate					0.63	16	4T-7629			

Number in parentheses () after the part number indicates the quantity required.

Ground Engaging Tools - Compactor Blades

Compactor Cutting Edges

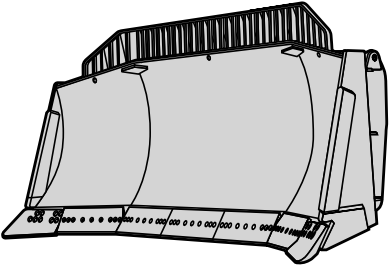

Universal Blade

- A straight blade with large “wings” to carry large loads more efficiently over long distances. Available only for larger models.

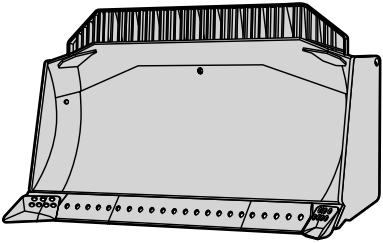

Semi-U Blade

- A straight blade with small “wings” to provide better load carrying characteristics for mid-sized and large machines.

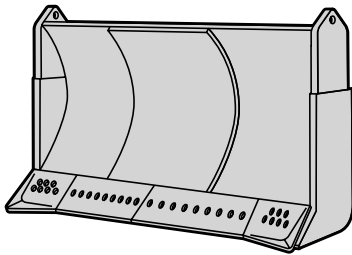

Cushion Blade

- A relatively narrow blade, primarily for pushing scrapers.

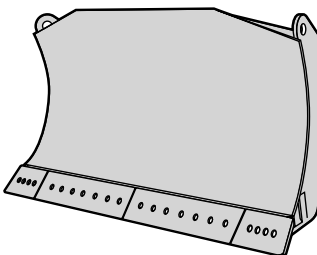

Power Angle and Tilt Blade

- A very versatile blade for smaller machines.

Ground Engaging Tools - Compactor Cutting Edges

Compactor Cutting Edges

Caterpillar compactor cutting edges are made of through-hardened alloy steel for excellent abrasion resistance and strength, and all Caterpillar compactor cutting edges are guaranteed against breakage. Caterpillar compactor cutting edges are available in various thicknesses to match your machine size and application, and they are available in shorter lengths for ease of storage, handling, installation, and maintenance.

Caterpillar compactor cutting edges are made of DH-2 steel.

- DH-2 steel provides increased hardness and toughness for excellent wear and impact resistance.

Caterpillar compactor cutting edges are made of through-hardened alloy steel for excellent abrasion resistance and strength, and all Caterpillar compactor cutting edges are guaranteed against breakage. Caterpillar compactor cutting edges are available in various thicknesses to match your machine size and application, and they are available in shorter lengths for ease of storage, handling, installation, and maintenance.

Caterpillar compactor cutting edges are made of DH-2 steel.

- DH-2 steel provides increased hardness and toughness for excellent wear and impact resistance.

Ground Engaging Tools - Compactor Cutting Edges

MODEL	SERIAL NUMBER	BLADE MODEL	EDGE THICKNESS (in) (mm)	EDGE TYPE	EDGE PART NUMBER	BOLTS PER EDGE	NUTS PER EDGE	WASHERS PER EDGE
814	36S,16Z,3YP 56D,23K		0.75 19	Right/Left End Edges	4T-2923	5J-2409	2J-3505	5P-8249
				Center Edge	4T-2922	5J-2409	2J-3505	5P-8249
				Right/Left End Edges	4T-2922	6F-019	2J-3505	
815	24K1-1044,59E1-341 24K1045-UP,59E342-UP		1.00 25	Center Edge	4T-2993	6F-0196	2J-3505	
				Left/Right End Edges	4T-2922	6F-0196	2J-3505	
				Left/Right end Edges	4T3020	3F5108	4K0567	
816	41S,15Z,3ZP 51K		0.75 19	Center Edge	4T3008	3F5108	4K0567	
				Center Edge	4T3004	4F7827	2J3506	
				Center Edge	4T3012	5J4773	2J3506	
824	2HP 35G		0.75 19	Left/Right End Edges	4T2923	5J2409	2J3505	
				Center Edge	4T2922	5J2409	2J3505	
				Left/Right End Edges	4T6532	6F0196	2J3505	
825	88H 4JP 89X		1.00 25	Center Edge	4T6531	6F0196	2J3505	
				Left End Edge	122-9227 (2)	6F0196	2J3505	
				Right/Center End Edges	4T3420	6F0196	2J3505	
826	97X,90K,2GP 14B	Straight	1/00 25	Center Edge	4T6514 (2)	5J2409	2J3505	
				Left/Right End Edges	107-3524+	5J2409	2J3505	
				Center Edge	109-9014 (2)+	5J2409	2J3505	
834	64G 93G,93GB	Cushion	1.00 25	Center Edge	4T6448 (2)	4J9058	2J3507	
				Center Edge	4T6532	6F0196	2J3505	
				Center Edge	4T6238	4F4042	2J3507	
834G	27K,14B,36G,96G		1.00 25	Center Edge	4T6515 (2)	5J2409	2J3505	
				Left/Right End Edges	4T8798	6F0196	2J3505	
				Center Edge	4T8797 (2)	6F0196	2J3505	
835	27K,36G,96G		1.00 25	Center Edge	4T2889 (2)	6F0196	2J3505	
				Left/Right Edges	4T6532	6F0196	2J3505	
				Center Edge	4T6531	6F0196	2J3505	
834G	27K,14B,36G,96G		2.36 60	Left End Edge	123-3756+	5J2409	2J3505	
				Center Edge	123-3754(2)+	5J2409	2J3505	
				Right End Edge	123-3755+	5J2409	2J3505	
835	27K,36G,96G		1.00 25	Center Edge	4T6515(2)	5J2409	2J3505	

Number in parentheses () after the part number indicates the quantity required.
 ** Extended Wear Life edge. Edge is wider and contains offset bolt holes. Use only Extended Wear Life end bits.
 * Edges are 11" (280 mm) wide.
 + Heavy Duty Mining Edge.

Ground Engaging Tools - Compactor End Bits

Compactor End Bits

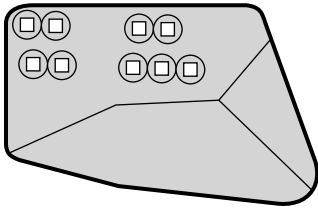

General Duty End Bits

- Provide a thicker wear area than the cutting edge.
- Made from DH-2 or DH-3 steel, depending on the application.
- For use in most dozing applications.
- Provide a thicker wear area than the cutting edge.
- Made from DH-2 or DH-3 steel, depending on the application.
- For use in most dozing applications.

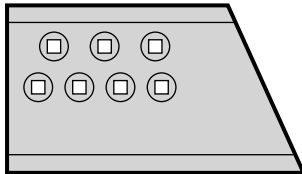

Finish Dozing End Bits

- Provide a depth of cut equal to the cutting edge.
- Protect the blade corner in low impact, low abrasion materials.
- Made from through-hardened DH-2 steel.
- For use in finish and semifinish dozing.

Ground Engaging Tools - Compactor End Bits

MODEL	SERIAL NUMBER	BLADE MODEL	THICKNESS		GENERAL DUTY END BITS		FINISH DOZING END BITS		BOLTS	NUTS	WASHERS
			(in)	(mm)	(lh)	(rh)	(lh)	(rh)			
814	36S,41S,3ZP 56D,51K,23K		1.12	28			4T6242	4T6241	5J2409	2J3505	5P8249
			0.88	22	3G8294	3G9283	4T6506	4T6505	6F0196	2J3505	
815	24K1-1044 24K1045-UP		1.12	28	4J8844	4J8843	4T6506	4T6505	6F0196	2J3505	
			0.75	19	9F7076	9F7075	4T3050	4T3049	3F5108	4K0367	
815S	39S,95E 36S,41S,3ZP,3YP 56D,51K,23K	Straight Straight	0.88	22	3G8296	3G8295	4T3050	4T3049	3F5108	4K0367	
			0.75	19	4J8262	4J8261	4T3042	4T3041	4F7827	2J3506	
816	59E1-341 59E342-UP		0.88	22	3G8298	3G8297	4T3042	4T3041	4F7827	2J3506	
			0.88	22	3G8296	3G8295	4T3050	4T3049	3F5108	4K0367	
824	2HP,35G,64G,93G	Straight Straight	0.88	22	3G8298	3G8297	4T3042	4T3041	4F7827	2J3506	
			0.88	22	5J1420	5J1419	4T3046	4T3045	5J4773	2J3506	
824S	88H	Straight	0.88	22	3G8298	3G8297	4T3046	4T3045	5J4773	2J3506	
			1.12	28			4T6242	4T6241	5J2409	2J3505	5P8249
825	4JP,93G 89X	Straight	0.88	22	3G8294	3G8293	3G8294	3G8293	6F0196	2J3505	
			1.12	28	4J8844	4J8843	4T6506	4T6505	6F0196	2J3505	
826	27K,14B,36G 97X,90K,2GP,93G	Straight	2.36	60	109-9025*	109-9024*					
			1.38	35	3G8290	3G8289			4J9208	2J3507	
834	27K,14B,36G 64G,93G,96G	Straight	1.58	40	3G8282	3G8281			4J9208	2J3507	
			2.36	60	109-9025*	109-9024*			5J2406	2J3505	
834G	27K,14B,36G 64G,93G,96G	Straight	1.12	28	3G8316	3G8315	4T6506	4T6505	6F0196	2J3505	
			1.12	28	3G8288	3G8287	4T6240	4T6239	4F4042	2J3505	
835	27K,14B,36G,64G, 93G,96G	Straight	1.18	30	9J1478	9J1477	4T6240	4T6239	4F4042	2J3505	
			0.88	22	3G8318	3G8317	4T6240	4T6239	4F4042	2J3505	
835	27K,14B,36G,64G, 93G,96G	Straight	0.88	22	3G8294	3G8293	4T6506	4T6505	6F0196	2J3505	
			1.12	28	3G8316	3G8315	4T6506	4T6505	6F0196	2J3505	
834G	27K,14B,36G 64G,93G,96G	Straight	1.12	28	4J8844	4J8843	4T6506	4T6505	6F0196	2J3505	
			0.88	22	3G8316	3G8315	4T6506	4T6505	6F0196	2J3505	
835	27K,14B,36G,64G, 93G,96G	Straight	2.36	60	124-7285*	124-7284*					
			0.88	22	3G8294	3G8293	4T6506	4T6505	6F0196	2J3505	
834G	27K,14B,36G 64G,93G,96G	Straight	1.12	28	4J8844	4J8843	4T6506	4T6505	6F0196	2J3505	
			0.88	22	3G8316	3G8315	4T6506	4T6505	6F0196	2J3505	

* Heavy Duty Mining end bit.
Number in parentheses () after the part number indicates the quantity required.

Ground Engaging Tools - Compactor Plates / Tips

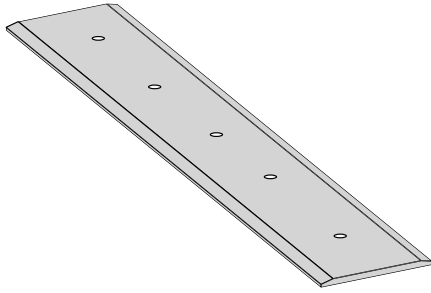

Compactor Sole Plates

MODEL	SERIAL NUMBER	BLADE MODEL	SOLE PLATE	BOLTS PER PLATE	NUTS PER PLATE
814	23K,56D	Straight	4T-3019 (2)	5J-4773 (5)	2J-3506 (5)
814	36S,3YP	Straight	4T-3018 (2)	5J-4773 (4)	2J-3506 (4)
824	2HP	Cushion	4T-8799 (3)	5J-4772 (5)	2J-3505 (5)
824	35G1-222	Straight	7T-3491 (3)	5J-4773 (7)	2J-3506 (7)
824	35G223-Up	Straight	7T-3492 (3)	5J-4773 (7)	2J-3506 (7)
834	14B	Universal	4T-8799 (2)	6F-0196 (7)	2J-3505 (7)
834	36G,96G	Straight	4T-6650 (2)	5J-4772 (8)	2J-3505 (8)
834	36G,96G	Straight	4T-6651 (1)	5J-4772 (9)	2J-3505 (9)
834	64G	Cushion	4T-6645 (2)	5J-4772 (6)	2J-3505 (6)

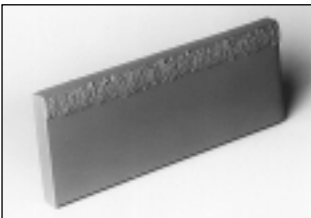
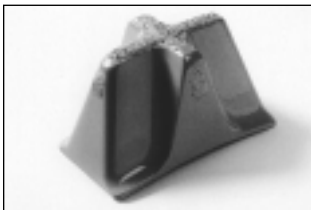
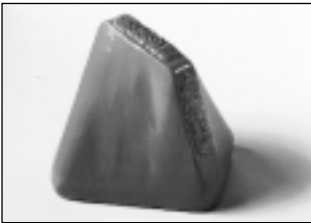

Landfill Compactor Tip / Blades

Landfill Compactor Traction Tips:

- Forged for maximum strength and equipped with A.R.M. for critical wear areas.
- For use in applications where maximum traction is required, such as frozen or difficult to penetrate materials.

Landfill Compactor Weld-On Plus Tips:

- Provide superior compaction densities, excellent traction, and excellent side hill stability.
- Provide less plugging and lower replacement costs because fewer teeth are required in its widely spaced distribution pattern.
- Last longer than chopper blades in high wear conditions.

A.R.M. Chopper Blades:

- Provide good traction and aggressive chopping action in all types of trash.
- Manufactured from heat-treated, DH-2 steel.
- For use in sanitary landfill applications.

MODEL	WHEEL DIAMETER (in)	TRACTION TIP		WELD-ON PLUS TIP	A.R.M. CHOPPER BLADE	A.R.M. CHOPPER BLADE SUPPORT	
		(lh)	(rh)			(lh)	(rh)
816B,816C		107-3487 (20)	107-3488 (40)	138-6464 (20)	6Y-6766 (20)	2V-6400 (10)	2V-6401 (10)
816B,816C		107-3487 (20)	107-3488 (40)	138-6464 (20)	6Y-6766 (20)	2V-6400 (10)	2V-6401 (10)
826B,826C	40	107-3487 (20)	107-3488 (44)	138-6464 (25)	6Y-4321 (24)	2V-6400 (12)	2V-6401 (12)
826B,826C	48	107-3487 (20)	107-3488 (45)	138-6464 (25)	6Y-4321 (24)	2V-6400 (12)	2V-6401 (12)
826B,826C	40	107-3487 (44)	107-3488 (44)	138-6464 (25)	6Y-4321 (24)	2V-6400 (12)	2V-6401 (12)
826B,826C	48	107-3487 (45)	107-3488 (45)	138-6464 (25)	6Y-4321 (24)	2V-6400 (12)	2V-6401 (12)
836				138-6464 (35)	107-3374 (28)	2V-6400 (14)	2V-6401 (14)
836G				138-6464 (35)	107-3374 (28)	2V-6400 (14)	2V-6401 (14)

Ground Engaging Tools - Compactor Feet

Landfill Compactor Wheel Assemblies

MODEL	RIM THICKNESS		WELD-ON PLUS TIP	NARROW WELD-ON PLUS TIP	A.R.M. CHOPPER BLADE	
	(in)	(mm)			(lh front and rh rear)	(rh front and lh rear)
816	0.625	16	2Q-1498 (4)		4E-3523 (2)	4E-3524 (2)
826	1.000	25	128-8113 (4)	2Z-9142 (4)*	128-8116 (2)	128-8117 (2)
836	1.000	25	129-2405 (4)		111-8237 (2)	111-8238 (2)
836G	1.000	25	143-5952		189-1584	189-1585
836G	1.000	25	165-4970**			

* Applicable for a narrow wheel width (40"). Only available for machine orders.

** Includes wheel extension.

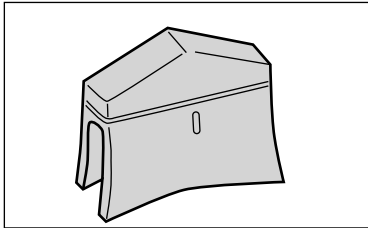

Weld-On Soil Compactor Feet

MODEL	BLADE SERIAL NUMBER	TAMPING FOOT	ROCK TAMPING FOOT	BASE
815	91P		4V-3851	7K-6908
815B	17Z	2V-7053		7K-6908
825C	86X	2V-6628	4V-0668	7K-7071

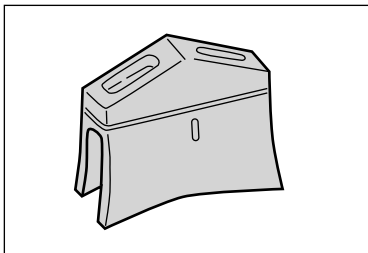

Bolt-On Soil Compactor Feet

MODEL	BLADE SERIAL NUMBER	TAMPING FOOT	BASE	BOLTS	NUTS	WASHERS
815	91P	8K-9189	7K-6908	0S-0484 (2)	6B-6684 (2)	5P-8245 (4)
825C	86X	8K-9171	7K-7071	0T-0856 (2)	6B-6682 (2)	5H-1504 (4)
835	44N333-UP	8K-9171	7K-7071	0T-0856 (2)	6B-6682 (2)	5H-1504 (4)

Ground Engaging Tools - Compactor Feet / Cleaner Bars

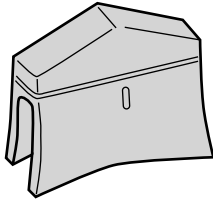

Pin-On Soil Compactor Feet

MODEL	BLADE SERIAL NUMBER	TAMPING FOOT	ROCK TAMPING FOOT	SHEEPSFOOT	BASE	PIN	SPRING ASSEMBLY	SNAP RING
824B	36H	7K-2939	7K-2939		9S-1645	7K-9535	9S-1644	5S-1522
824B,C,G	36H,85X,45N			3S-3992		7K-9937	9S-1644	5S-1522
825B	43N	7K-2939			9S-1645	7K-9535	9S-1644	5S-1522
825C,G	86X,6RN			3S-3992		7K-9937	9S-1644	5S-1522
834	43E	7K-2939		3S-3992	9S-1645	7K-9535	9S-1644	5S-1522
835	44N1-332	7K-2939		3S-3992	9S-1645	7K-9535	9S-1644	5S-1522

Compactor Cleaner Bars

MODEL	BLADE SERIAL NUMBER	TAMPING FOOT CLEANER BAR	ROCK TAMPING FOOT CLEANER BAR	SHEEPSFOOT CLEANER BAR	LANDFILL CLEANER BAR
815	91P	4S-7928			
815B,F	17Z,1GN	106-204,141-7407, 3G8250*			
816B,F	15Z, 5FN				71-3968
824B	36H	3S-3228	3S-3228	4S-7928	
825B	36H,43N	3S-3228**	3S-3228	4S-7928	
825C,825G	86X,6RN	3S-3228**	3G-8250*		
826B	58U				71-3968
826C	87X				71-3968
826G	7LH				71-3968
834	43E	4S-7928	4S-7928	3S-3228	
835	44N	4S-7928	4S-7928	3S-3228	
836					71-3968

* Replaceable Tip — use 8E-6258 Pin and 8E-6259 Retainer.

** Optional one-way cleaner bar available: front wheel — 9V-5074; rear wheel — 9V-5073.

Ground Engaging Tools - Compactor Wear Plates

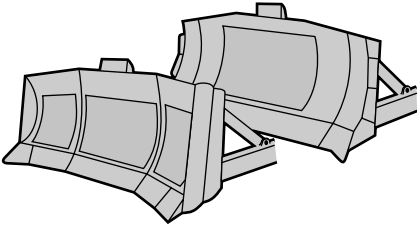

Compactor Reinforcing Wear Plates

- Provide extended blade life in highly abrasive or extreme impact conditions.
- Provide a repair or resurface option for worn or damaged moldboards.
- Formed to fit the curve of the blade so they are easily installed.
- Provide extended blade life in highly abrasive or extreme impact conditions.
- Provide a repair or resurface option for worn or damaged moldboards.
- Formed to fit the curve of the blade so they are easily installed.

Model	Serial Number	Item	Plate Thickness		Reinforcing Wear Plate
			(in)	(mm)	
816	41S,51K	Wear Plate	0.31	8	3J-3141
824	88H	Wear Plate	0.47	12	6J-0164 (2)
		Wear Plate	0.47	12	2J-8523 (4)
824C	2HP,64G	Wear Plate	0.79	20	5J-2663
		Pusher Plate	0.79	20	4J-5622
		Wear Plate	0.79	20	4J-5622
824F	93G	Wear Plate	0.31	8	3J-3141
824G		Wear Plate	0.79	20	5J-2663
825	89X,93G	Wear Plate	0.31	8	3J-3141
826	97X,90K	Wear Plate	0.31	8	3J-3141
834C	64G	Pusher Plate	0.79	20	4J-5622
		Wear Plate	0.79	20	4J-5622
	96G	Wear Plate	0.31	8	3J-3142
835	27K	Wear Plate	0.31	8	3J-3141

GROUND ENGAGING TOOLS - EXCAVATOR

300-Family, B-Series Excavator Buckets	254
300-Family, A-Series; E-Family; and 200-Family Excavator Buckets ...	260
Tips	269
Sidecutters	272



Ground Engaging Tools - Excavator Buckets

300-Family, B-Series Excavator Buckets

Caterpillar 300-Family, B-Series excavator buckets have high-strength base edges that are through-hardened for long wear life and breakage resistance.

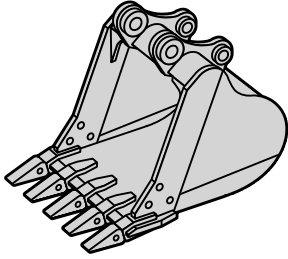

General Purpose Bucket

- Provides greater capacity.
- Decreases load time and reduces bucket weight due to lighter structures.
- For use in low impact, moderately abrasive soils.

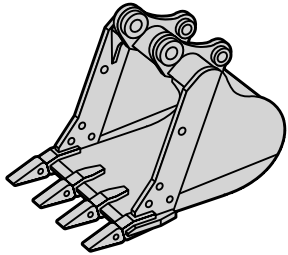

Heavy Duty Bucket

- Provides greater wear and dent protection due to thicker wear plates.
- For use in abrasive or hard to penetrate soils.

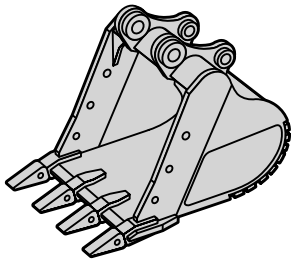

Heavy Duty Rock Bucket

- Provides enhanced wear and dent protection due to thicker bottom wear plates and larger lower wear plates.
- For use in fragmented rock, frozen ground, caliche, and highly abrasive materials.

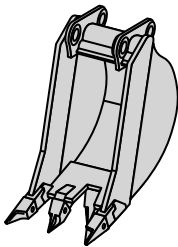

Rock Ripping Bucket

- Allows for ripping-type digging action due to a stepped tooth design.
- For use where aggressive penetration is needed and where blasting is a problem.

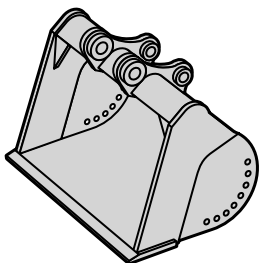

Ditch Cleaning Bucket

- Allows wet material to empty due to drainage holes.

Ground Engaging Tools - Excavator Buckets

BUCKET TYPE	BUCKET WIDTH (in)	BUCKET WIDTH (mm)	CUTTING EDGE ASSY. ①	TRANSVERSE WEAR STRIP FRONT	TRANSVERSE WEAR STRIP REAR	NUMBER OF TEETH	(lh)	(ctr)	(rh)	TIP SIZE
B Linkage										
General Purpose	30	775	104-2097	133-2301	100-5357 (3)	4	61-6356	61-6354 (2)	61-6355	J350
	36	925	127-8633	133-2302	108-6951 (3)	5	61-6356	61-6354 (3)	61-6355	J350
	42	1075	61-5193	133-2303	108-6952 (3)	5	61-6356	61-6354 (3)	61-6355	J350
	48	1225	129-5714	133-2304	136-2026 (3)	6	61-6356	61-6354 (4)	61-6355	J350
	54	1377	129-5719	153-7959	153-7960 (3)	7	616356	616354 (5)	616355	J350
	24	625	104-2096	162-2946	149-5219 (4)	3	616356	616354	616355	J350
	27	610	104-2096	127-8624	128-0700 (3)	3	61-6356	61-6354	61-6355	J350
	30	775	104-2097	127-8626	127-6942 (3)	4	61-6356	61-6354 (2)	61-6355	J350
	36	925	127-8633	127-5088	127-2281 (3)	5	61-6356	61-6354 (3)	61-6355	J350
	42	1075	137-9526	127-5089	123-3212 (3)	5	61-6356	61-6354 (3)	61-6355	J350
Heavy Duty	48	1225	129-5714	127-2287	127-2288 (3)	6	61-6356	61-6354 (4)	61-6355	J350
	54	1375	129-5719	127-2294	127-2295 (3)	7	61-6356	61-6354 (5)	61-6355	J350
	60	1525	127-1539	193-4923	127-2303 (3)	7	61-6356	61-6354 (5)	61-6355	J350
	30	775	104-2097	148-8849	134-1910 (4)	4	61-6356	61-6354 (2)	61-6355	J350
					134-1911 (4)					
	36	925	127-8633	148-8850	134-1914 (4)	5	61-6356	61-6354 (3)	61-6355	J350
					134-1915 (4)					
	42	1075	137-9526	148-8851	134-1917 (4)	5	61-6356	61-6354 (3)	61-6355	J350
					134-1918 (4)					
	Ditch Cleaning	56	1420	135-8636						
	68	1720	135-8637							
C Linkage										
General Purpose	30	775	105-2761	133-2243	100-4346 (4)	3	61-6406	61-6404	61-6405	J400
	36	925	132-8418	133-2244	113-7682 (4)	5	61-6356	61-6354 (3)	61-6355	J350
	42	1075	61-5193	133-2245	111-6072 (4)	5	61-6356	61-6354 (3)	61-6355	J350
	48	1255	125-5714	133-2246	112-9696 (4)	5	61-6356	61-6354 (3)	61-6355	J350
	54	1375	125-5719	133-2248	112-9701 (4)	6	61-6356	61-6354 (4)	61-6355	J350
	30	775	105-2761	127-5710	127-5711 (4)	3	61-6406	61-6404	61-6405	J400
	36	925	127-2282	127-5088	127-2281 (4)	4	61-6406	61-6404 (2)	61-6405	J400
	42	1075	126-3718	127-5089	123-3212 (4)	5	61-6406	61-6404 (3)	61-6405	J400
	48	1255	127-2289	127-2287	127-2288 (4)	5	61-6406	61-6404 (3)	61-6405	J400
	54	1375	127-2296	127-2294	127-2295 (4)	6	61-6406	61-6404 (4)	61-6405	J400
Heavy Duty	60	1520	127-2304	127-2302	127-2303 (4)	7	61-6406	61-6404 (5)	61-6405	J400
	66	1680	127-2316	127-2314	127-2315 (4)	7	61-6406	61-6404 (5)	61-6405	J400

① Consists of base edge and adapters.
Number in parentheses () after the part number indicates the quantity required.

Ground Engaging Tools - Excavator Buckets

BUCKET TYPE	BUCKET WIDTH (in)	BUCKET WIDTH (mm)	BASE EDGE ASSY. ①	FRONT	TRANSVERSE WEAR STRIP REAR	NUMBER OF TEETH	(lh)	ADAPTERS (ctr)	(rh)	TIP SIZE
C Linkage (cont.)										
Heavy Duty Rock	30	775	105-2761	162-6893	162-6894 (4) 162-6895 (4)	3	616406	616404	616405	J400
	36	925	127-2282	134-1913	150-4535 (4) 134-1915 (4)	4	61-6406	61-6404 (2)	61-6405	J400
	42	1075	126-3718	150-4595	134-1917 (4) 134-1918 (4)	5	61-6406	61-6404 (3)	61-6405	J400
	48	1255	127-2289	150-4601	134-1930 (4) 134-1931 (4)	5	61-6406	61-6404 (3)	61-6405	J400
	66	1680	135-3165							
Ditch Cleaning	72	1830	135-3167							
D Linkage										
General Purpose	30	775	105-2532	118-8713	118-8714 (4)	3	159-0466	159-0464	159-0465	J460
	36	925	105-2533	115-0034	115-0035 (4)	3	159-0466	159-0464	159-0465	J460
	42	1075	104-5747	133-2261	117-8961 (4)	5	61-6406	61-6404 (3)	61-6405	J400
	48	1225	104-5748	133-2262	117-8965 (4)	5	61-6406	61-6404 (3)	61-6405	J400
	55	1400	133-2321	133-2263	117-8974 (4)	5	61-6406	61-6404 (3)	61-6405	J400
	60	1525	615224	133-2264	133-8530 (4)	6	61-6406	61-6404 (4)	61-6405	J400
	30	775	105-2532	128-2942	128-2545 (3)	3	159-0466	159-0464	159-0465	J460
	36	925	105-2533	128-2947	128-2949 (3)	3	159-0466	159-0464	159-0465	J460
	42	1075	128-2954	128-2951	128-2952 (3)	4	159-0466	159-0464 (2)	159-0465	J460
	48	1225	123-3220	128-2677	123-3219 (3)	5	159-0466	159-0464 (3)	159-0465	J460
Heavy Duty	55	1400	117-8975	117-8973	128-5353 (3)	5	159-0466	159-0464 (3)	159-0465	J460
	60	1525	128-5366	128-5364	128-5365 (3)	6	159-0466	159-0464 (4)	159-0465	J400
	66	1680	128-5379	128-5377	128-5378 (3)	6	159-0466	159-0464 (4)	159-0465	J460
	72	1830	128-5389	128-5387	128-5388 (3)	7	159-0466	159-0464 (5)	159-0465	J460
	42	1075	128-2954	134-1922	134-1923 (5) 134-1924 (3)	4	159-0466	159-0464 (2)	159-0465	J460
	48	1225	123-3220	134-5030	134-5031 (5) 134-5032 (3)	5	159-0466	159-0464 (3)	159-0465	J460
	55	1400	117-8975	134-5033	134-5034 (5) 134-5035 (3)	5	159-0466	159-0464 (3)	159-0465	J460
	35	900	61-5663	7Y-9121		5	107-3465	107-3464	107-3465	J460
	Ditch Cleaning	66	1680	135-3163						
		70	1800	135-3164						

① Consists of base edge and adapters.
Number in parentheses () after the part number indicates the quantity required.

Ground Engaging Tools - Excavator Buckets

BUCKET TYPE	BUCKET WIDTH		BASE EDGE ASSY. ①	TRANSVERSE WEAR STRIP		NUMBER OF TEETH	ADAPTERS			TIP SIZE	
	(in)	(mm)		FRONT	REAR		(lh)	(ctr)	(rh)		
S Linkage											
General Purpose	24	610	104-2096	133-2298	100-6479 (3)	3	61-6356	61-6354	61-6355	J350	
	30	775	105-2761	133-2243	100-4346 (4)	3	61-6406	61-6404	61-6405	J400	
	36	925	132-8418	133-2244	113-7682 (4)	5	61-6356	61-6354 (3)	61-6355	J350	
	42	1075	61-5193	133-2245	111-6072 (4)	5	61-6356	61-6354 (3)	61-6355	J350	
	48	1225	129-5714	133-2246		6	61-6356	61-6354 (4)	61-6355	J350	
	54	1375	129-5719	133-2248		7	61-6356	61-6354 (5)	61-6355	J350	
	Heavy Duty	24	610	104-2096	127-8624	127-0700 (3)	3	61-6356	61-6354	61-6355	J350
		30	775	105-2761	127-5710	127-5711 (4)	3	61-6406	61-6404	61-6405	J400
		36	925	127-2282	127-5088	127-2281 (4)	4	61-6406	61-6404 (2)	61-6405	J400
		42	1075	126-3718	127-5089	123-3212 (4)	5	61-6406	61-6404 (3)	61-6405	J400
		48	1225	127-2289	127-2287		5	61-6406	61-6404 (3)	61-6405	J400
		54	1375	127-2296	127-2294		6	61-6406	61-6404 (4)	61-6405	J400
		60	1525	127-2304	127-2302		7	61-6406	61-6404 (5)	61-6405	J400
		36	925	127-2282	134-1913	134-1914 (4) 134-1915 (4)	4	61-6406	61-6404 (2)	61-6405	J400
Heavy Duty Rock	42	1075	126-3718	134-1916	134-1917 (4) 134-1918 (4)	5	61-6406	61-6404 (3)	61-6405	J400	
	48	1225	127-2289	134-1929	134-1930 (4) 134-1931 (4)	5	61-6406	61-6404 (3)	61-6405	J400	
	62	1575	135-8634								
	72	1830	135-8635								
	F Linkage										
	General Purpose	36	920	137-4105	145-8085	145-8086 (4)	3	159-0466	159-0464	159-0465	J460
		42	1067	137-4106	145-8088	145-8089 (4)	4	159-0466	159-0464 (2)	159-0465	J460
		48	1230	146-0233	146-0231	146-0232 (4)	5	616406	616404 (3)	616405	J400
		48	1230	137-4107	145-8091	145-8092 (4)	5	159-0466	159-0464 (3)	159-0465	J460
		54	1372	137-4108	145-8112	145-8113 (4)	5	159-0466	159-0464 (3)	159-0465	J460
62		1575	145-8108	145-8099	145-8100 (4)	6	159-0466	159-0464 (4)	159-0465	J460	
68		1727	145-8109	145-8105	145-8106 (4)	7	159-0466	159-0464 (5)	159-0465	J460	
36		920	137-4105	136-6269	128-2949 (4)	3	159-0466	159-0464	159-0465	J460	
42		1067	137-4106	136-6274	128-2953 (4)	4	159-0466	159-0464 (2)	159-0465	J460	
48		1230	137-4107	136-6279	123-3219 (4)	5	159-0466	159-0464 (3)	159-0465	J460	
Heavy Duty	54	1372	137-4108	136-6284	128-5353 (4)	5	159-0466	159-0464 (3)	159-045	J460	
	60	1524	137-4109	136-6289	128-5365 (4)	6	159-0466	159-0464 (4)	159-0465	J460	
	72	1829	137-4111	136-6299	128-5388 (4)	7	159-0466	159-0464 (5)	159-0465	J460	

① Consists of base edge and adapters.
Number in parentheses () after the part number indicates the quantity required.

Ground Engaging Tools - Excavators

BUCKET TYPE	BUCKET WIDTH (in)	BUCKET WIDTH (mm)	BASE EDGE ASSY. ①	FRONT	REAR	NUMBER OF TEETH	(lh)	(ctr)	(rh)	TIP SIZE
Heavy Duty Rock	42	1067	137-4106	138-7545	134-1923 (5) 134-1924 (2)	4	159-0466	159-0464 (2)	159-0465	J460
	48	1230	137-4107	138-7546	134-5031 (5) 134-5032 (2)	5	159-0466	159-0464 (3)	159-0464	J460
	54	1400	137-4108	138-8182	134-5034 (5) 134-5035 (2)	5	159-0466	159-0464 (3)	159-0465	J460
G Linkage										
Heavy Duty	67	1710	138-4728	138-4726	138-4727 (4)	6	616556	616554 (4)	616555	J550
	75	1900	138-2395	138-2392	138-2393 (4)	6	616556	616554 (4)	616555	J550
Heavy Duty Rock	75	1900	138-2395	143-5421	143-5422 (2) 143-5423 (3)	6	616556	616554 (4)	616555	J550
	V Linkage									
General Purpose	36	920	175-4574	175-4575	175-4518 (6)	3	616556	616554	616555	J550
	48	1230	183-4098	169-2845	175-4526 (6)	4	616556	616554 (2)	616555	J550
	54	1400	175-4534	175-4537	175-4538 (6)	4	616556	616554 (2)	616555	J550
	60	1545	183-4096	169-2848	169-2847 (6)	5	616556	616554 (3)	616555	J550
	66	1690	183-4097	169-6234	175-4547 (6)	5	616556	616554(3)	616555	J550
	75	1905	180-8267	180-8275	180-8276 (6)	6	616556	616554 (4)	616555	J550
	36	920	175-4514	175-4515	175-4519 (7)	3	616556	616554	616555	J550
	48	1230	183-4098	169-2845	169-2844 (7)	4	616556	616554 (2)	616555	J550
	54	1400	175-4534	175-4537	175-4539 (7)	4	616556	616554 (2)	616555	J550
	60	1545	183-4096	169-2848	175-4543 (7)	5	616556	616554 (3)	616555	J550
Heavy Duty Rock	66	1690	183-4097	169-6234	165-6236 (7)	5	616556	616554 (3)	616555	J550
	75	1905	180-8267	180-8275	175-4560 (7)	6	616556	616554 (4)	616555	J550
	36	920	175-4514	175-4515	175-4520 (6) 175-4521 (2)	3	616556	616554	616555	J550
	48	1230	183-4098	169-2845	175-4527 (6) 175-4528 (2)	4	616556	616554 (2)	616555	J550
	54	1400	175-4534	175-4537	175-4540 (6) 175-4541 (2)	4	616556	616554 (2)	616555	J550
	60	1545	183-4096	169-2848	175-4544 (6) 175-4545 (2)	5	616556	616554 (3)	616555	J550
	66	1690	183-4097	169-6234	175-4548 (6) 175-4549 (2)	5	616556	616554 (3)	616555	J550

① Consists of base edge and adapters. Number in parentheses () after the part number indicates the quantity required.

Ground Engaging Tools - Excavator Buckets

BUCKET TYPE	BUCKET WIDTH (in)	BUCKET WIDTH (mm)	BASE EDGE ASSY. ①	TRANSVERSE WEAR STRIP		NUMBER OF TEETH	ADAPTERS			TIP SIZE
				FRONT	REAR		(lh)	(ctr)	(rh)	
Heavy Duty Rock (cont.)	75	1905	180-8267	180-8275	175-4561 (6) 175-4562 (2)	6	616556	616554 (4)	616555	J550
W Linkage										
Excavation	89	2250	174-5099	174-5102 (7)		5	616606	616604 (3)	616605	J600
Extreme Excavation	79	2000	174-8631	174-8641 (7)		4	616606	616604 (2)	616605	J600
Spade Rock	79	2000	174-8636	174-8644 (7)		4	618606 (2)		618605 (2)	J600

① Consists of base edge and adapters.
Number in parentheses () after the part number indicates the quantity required.

Ground Engaging Tools - Excavator Buckets

300-Family, A-Series; E-Family; and 200-Family Excavator Buckets

Caterpillar 300-Family, A-Series; E-Family; and 200-Family excavator buckets have high-strength base edges that are through-hardened for long wear life and breakage resistance.

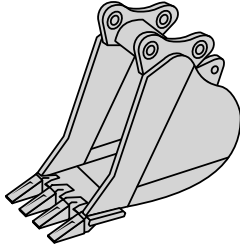

Trenching Bucket

- For use in trenching materials such as packed ground and tough clay.

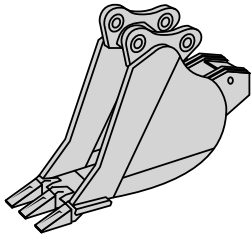

Extreme Service Trenching Bucket

- For use in tough trenching of materials such as sandstone, limestone, and caliche.

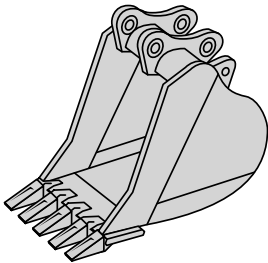

Excavation Bucket

- For use in excavation of packed ground and tough dry clay where a wide bucket is needed.

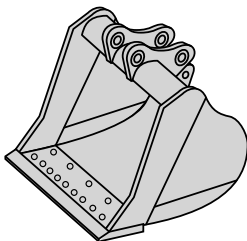

Light Excavation (Utility) Bucket

- For use in loose material and rehandling.

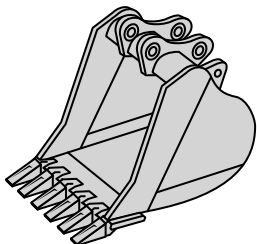

Extreme Service Excavation Bucket

- For use in tough excavation of materials such as sandstone, limestone, and caliche where up to 50% of the content is decomposed or fragmented.

Ground Engaging Tools - Excavator Buckets

300-Family, A-Series; E-Family; and 200-Family Excavator Buckets

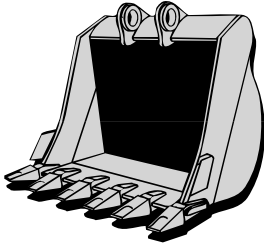

Mass Excavation Bucket

- For use in volume loading of materials such as packed ground and tough dry clay.

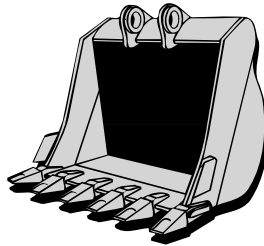

Extreme Service Mass Excavation Bucket

- For use in tough mass excavation of materials such as sandstone, limestone, and caliche.

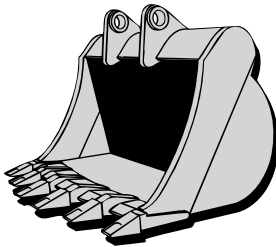

Rock Mass Excavation Bucket

- For use in heavy duty mass excavation of materials such as shot rock.

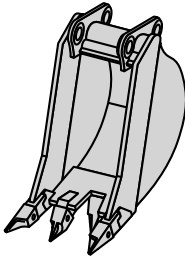

Rock Ripping Bucket

- Allows for ripping-type digging action due to a stepped tooth design.
- For use where aggressive penetration is needed and where blasting is a problem.

Ground Engaging Tools - Excavator Buckets

BUCKET TYPE	BUCKET WIDTH		BASE EDGE ASSY. ①	NUMBER OF TEETH	ADAPTERS			TIP SIZE
	(IN)	(MM)			(lh)	(ctr)	(rh)	
B Linkage								
Trenching	35	890	7Y9133	5		8E-9490		J300
	39	1000	7Y-9111	5		8E-9490		J300
Extreme Service Trenching	24	625	104-2096	3	6I-6356	6I-6354	6I-6355	J350
	30	775	104-2097	3	6I-6356	6I-6354	6I-6355	J350
	42	1075	6I5193	5	6I-6356	6I-6354 (3)	6I-6355	J350
Excavation	44	1120		5		8E-9490		J300
	47	1200	4I4014	6		8E-9490		J300
	49	1260	165-0834	6		8E-9490		J300
	54	1370	165-0865	6		8E-9490		J300
		1370	7I6707	6		8E9490		J300
		1370	129-5719	6		8E-9490		J300
Extreme Service Excavation	43	1092	9C819	5	6I-6356	6I-6354 (3)	6I-6355	J350
	44	1115	6I5787	5	6I-6356	6I-6354 (3)	6I-6355	J350
C Linkage								
Trenching	31	800	6I5208	4	6I-6356	6I-6354 (2)	6I-6355	J350
	36	925	132-8418	5	6I-6356	6I-6354	6I-6355	J350
	42	1075	6I5193	5	6I-6356	6I-6354 (3)	6I-6355	J350
	48	1225	104-3436	6	6I-6356	6I-6354 (4)	6I-6355	J350
		1225	129-5714	6	6I-6356	6I-6354 (4)	6I-6355	J350
	54	1375	6I5248	6	6I-6356	6I-6354 (4)	6I-6355	J350
Extreme Service Trenching	30	775	105-2761	3	6I-6406	6I-6404	6I-6405	J400
	32	823	6I5205	3	6I-6406	6I-6404	6I-6405	J400
	37	948	6I5281	4	6I-6406	6I-6404 (2)	6I-6405	J350
	42	1075	126-3718	5	6I-6406	6I-6404 (3)	6I-6405	J400
Excavation	53	1355	6I5198	6	6I-6356	6I-6354 (4)	6I-6355	J350
	54	1370	6I5248	6	6I-6356	6I-6354 (4)	6I-6355	J350
Light Excavation (Utility)	68	1730	135-3167					
Extreme Service Excavation	47	1200	127-2289	5	6I-6406	6I-6404 (3)	6I-6405	J400
Mass Excavation	57	1440	113-5930	7	6I-6356	6I-6354 (5)	6I-6355	J350
	59	1500	127-2304	7	6I-6356	6I-6354 (5)	6I-6355	J350
Extreme Service Mass Excavation	54	1378	6I5201	5	6I-6406	6I-6404 (3)	6I-6405	J400
D Linkage								
Trenching	42	1075	104-5747	5	6I-6406	6I-6404 (3)	6I-6405	J400
	48	1255	104-5748	5	6I-6406	6I-6404 (3)	6I-6405	J400
	54	1375	117-8975	5	159-0466	159-0464 (3)	159-0465	J400
Extreme Service Trenching	30	775	105-2532	3	159-0466	159-0464	159-0465	J460
	36	915	105-2533	3	159-0466	159-0464	159-0465	J460
Excavation	56	1430	133-2321	5	6I-6406	6I-6404 (3)	6I-6405	J400
	59	1500	6I5223	5	6I-6406	6I-6404 (3)	6I-6405	J400
Light Excavation (Utility)	71	1800	135-3164					
Extreme Service Excavation	48	1300	123-3220	5	159-0466	159-0464 (3)	159-0465	J460
	55	1400	117-8975	5	159-0466	159-0464 (3)	159-0465	J460
Mass Excavation	60	1520	6I5224	6	6I-6406	6I-6404 (4)	6I-6405	J400

① Consists of base edge and adapters.

② Consists of base edge and adapters.

Number in parentheses () after the part number indicates the quantity required.

Ground Engaging Tools - Excavator Buckets

BUCKET TYPE	BUCKET WIDTH		BASE EDGE ASSY. ②	NUMBER OF TEETH	ADAPTERS			TIP SIZE
	(IN)	(MM)			(lh)	(ctr)	(rh)	
E Linkage								
Excavation	63	1600	6I5240	5	159-0466	159-0464 (3)	159-0465	J460
		1600	109-8486	6	159-0466	159-0464 (4)	159-0465	J460
	68	1735	137-4110	6	159-0466	159-0464 (4)	159-0465	J460
Extreme Service Excavation	59	1504	6I5246	4	6I-6556	6I-6554 (2)	6I-6555	J550
Mass Excavation	68	1735	6I5241	6	159-0466	159-0464 (4)	159-0465	J460
Extreme Service Mass Excavation	64	1634	6I5247	4	6I-6556	6I-6554 (2)	6I-6555	J550
F Linkage								
Trenching	48	1225	123-4101	4	6I6556	6I6554 (2)	6I6555	J550
	54	1375	105-3580	5	159-0466	159-0464 (3)	159-0465	J460
	60	1525	122-9463	5	6I6556	6I6554 (3)	6I6555	J550
Extreme Service Trenching	36	925	137-4105	3	159-0466	159-0464	159-0465	J460
	42	1075	105-3622	3	6I-6556	6I-6554	6I-6555	J550
	48	1225	123-4101	4	6I-6556	6I-6554 (2)	6I-6555	J550
	60	1525	122-9463	5	6I-6556	6I-6554 (3)	6I-6555	J550
Excavation	63	1590	109-8486	6	159-0466	159-0464 (4)	159-0465	J460
	68	1735	137-4110	6	159-0466	159-0464 (4)	159-0465	J460
G Linkage								
Mass Excavation	75	1895	138-2395	6	6I-6556	6I-6554 (4)	6I-6555	J550
V-Type Excavation	74	1880	109-8492	4	105-6269 (2)		105-6270 (2)	J550
H Linkage								
Trenching	54	1380	107-9890	4	6I-6556	6I-6554 (2)	6I-6555	J550
	60	1560	100-5714	5	6I-6556	6I-6554 (3)	6I-6555	J550
	78	1990	108-7065	6	6I-6556	6I-6554 (4)	6I-6555	J550
Extreme Service Trenching	42	1075	100-6197	3	6I-6606	6I-6604	6I-6605	J600
	48	1225	100-6196	3	6I-6606	6I-6604	6I-6605	J600
Excavation	71	1800	6I5249	5	6I-6556	6I-6554 (3)	6I-6555	J550
	78	1990	108-1065	6	6I-6556	6I-6554 (4)	6I-6555	J550
J Linkage								
Trenching	60	1535	135-3715	5	113-9606	113-9604 (3)	113-9605	J600
Excavation	87	2210	107-9840	5	6I-6606	6I-6604 (3)	6I-6605	J600
Mass Excavation	82	2105	133-8868	6	113-9606	113-9604 (4)	113-9605	J600
	94	2390	119-3173	7	113-9606	113-9604 (5)	113-9605	J600
V-Type Excavation	81	2080	107-9842	6	6I-8606 (3)		6I-8605 (3)	J600
V-Type Mass Excavation	88	2260	126-9029	6	132-4706 (3)		132-4705 (3)	J700
S Linkage								
Trenching	36	925	127-2282	4	6I6406	6I6404 (2)	6I6405	J400
	42	1075	126-3718	5	6I6406	6I6404 (3)	6I6405	J400
	48	1225	127-2289	5	6I6406	6I6404 (3)	6I6405	J400
Extreme Service Trenching	30	775	105-2761	3	6I-6406	6I-6404	6I-6405	J400
Excavation	57	1440	127-2296	6	6I6406	6I6404 (4)	6I6405	J350
307								
General Purpose	20	508	110-9979 ^①	3		6Y-3224		J225
	24	610	110-9983 ^①	4		6Y-3224		J225
	28	711	111-0038 ^①	4		6Y-3224		J225
	31	787	106-6858 ^①	4		6Y-3224		J225

① Base edge only - does not include adapters.

② Consists of base edge and adapters.

Number in parentheses () after the part number indicates the quantity required.

Ground Engaging Tools - Excavator Buckets

BUCKET TYPE	BUCKET WIDTH		BASE EDGE ASSY. ②	NUMBER OF TEETH	ADAPTERS			TIP SIZE
	(IN)	(MM)			(lh)	(ctr)	(rh)	
311, 312								
General Purpose	24	610	086-0811 ^①	3		119-3253		J250
	28	711	086-0812 ^①	4		119-3253		J250
	35	889	086-0809 ^①	5		119-3253		J250
	36	914	085-9510 ^①	5		119-3253		J250
	39	991	086-0813 ^①	5		119-3253		J250
	43	1092	086-0814 ^①	5		119-3253		J250
315								
	24	610	115-2891	3		8E-9490		J300
	30	762	115-2901	4		8E-9490		J300
	36	914	115-2767	5		8E-9490		J300
	42	1067	117-5377	6		8E-9490		J300
	48	1219	117-5386	6		8E-9490		J300

① Base edge only - does not include adapters.

② Consists of base edge and adapters.

Number in parentheses () after the part number indicates the quantity required.

Ground Engaging Tools - Excavator Buckets

MODEL	BUCKET TYPE	BUCKET WIDTH		BASE EDGE ASSY ①	NUMBER OF TEETH	ADAPTERS		TIP SIZE	
		(in)	(mm)			(lh)	(ctr)		(rh)
205, 206, 211, 212, 213, 214	Ditch Cleaning	79	2000	5W-7957 ^②					
		91	2300	8U-2639 ^②					
		94	2400	5W-7958 ^②					
	Ejector	11	280	5W-7960	2	3G-0169		J250	
		15	380	5W-7961	2	3G-0169		J250	
	Rock					9J-8929		J300	
						1U-1254		J250	
	Trapezoidal					3G-0169		J250	
						3G-0169		J250	
	Trenching	20	510	5W-7935	3			J250	
		24	610	5W-7937	3			J250	
		24	610	5W-7938	3	1U-1350		J250	
		28	710	5W-7939	4	3G-0169		J250	
		28	710	5W-7940	4	1U-1350		J350	
		32	810	5W-7941	4	3G-0169		J250	
32		810	5W-7942	4	1U-1350		J350		
36		910	5W-7943	5	3G-0169		J250		
36		910	5W-7944	5	1U-1350		J350		
40		1010	5W-7945	5	3G-0169		J250		
40		1010	5W-7946	5	1U-1350		J350		
44		1110	5W-7947	5	3G-0169		J225		
44		1110	5W-7948	5	1U-1350		J350		
48		1210	5W-7950	5	3G-0169		J250		
48		1210	5W-7949	5	1U-1350		J350		
213B, 214B	General Purpose	52	1310	5W-7951	6	3G-0169		J250	
		56	1410	5W-7952	6	3G-0169		J250	
							9J-8929		J300
		30	760	8U-0955					
		40	1010	8U-0957 ^②					
215D, 219D	Rock								
	Trenching	24	610	9C-7381	3	1U-1350		J350	
		30	760	9C-4307	4	7T-3306	9W-1304	J300	
		36	910	9C-4308	5	7T-3306	9W-1304 (2)	J300	
Extreme Service Trenching	42	1070	9C-8019	5	7T-3306	9W-1304 (3)	J300		
					6I-6356	6I-6354 (3)	J350		

① Consists of base edge and adapters.

② Base Edge only.

Number in parentheses () after the part number indicates the quantity required.

Ground Engaging Tools - Excavator Buckets

MODEL	BUCKET TYPE	BUCKET WIDTH (in) (mm)	BASE EDGE ASSY ①	NUMBER OF TEETH	ADAPTERS			TIP SIZE		
					(lh)	(ctr)	(rh)			
215D, 219D (Cont.)	Excavation	42 1070	100-4139	5		8E-9490 (5)	7T-3305	J300		
		48 1210	9C-7287	6	7T-3306	9W-1304 (4)		7T-3305	J300	
		54 1370	9C-7315	6	7T-3306	9W-1304 (4)		7T-3305	J300	
	224	Ditch Cleaning	79 2000	5W-7957 ^②						
			94 2400	5W-7959 ^②						
		Rock	30 760	5W-7929 ^②	3		1U-1350			J350
			34 860	5W-7930 ^②						
			40 1010	5W-7931 ^②	4		1U-1350			J350
			44 1110	5W-9732 ^②						
			48 1210	5W-7933 ^②						
52 1310	5W-7934 ^②									
225D, 229	Trenching	20 510	5W-7936 ^②	3		9J-8929		J300		
		24 610	5W-7938 ^②	3		9J-8929		J300		
		28 710	5W-7940 ^②	3		9J-8929		J300		
		32 810	5W-7942 ^②	4		9J-8929		J300		
		36 910	5W-7944 ^②	4		9J-8929		J300		
		40 1010	5W-7946 ^②	4		9J-8929		J300		
		44 1110	5W-7948 ^②	5		9J-8929		J300		
		48 1210	5W-7949 ^②	5		9J-8929		J300		
		56 1410	5W-7953 ^②	6		9J-8929		J350		
		231D	Trenching	24 610	104-2096	3	6I-6356	6I-6354	6I-6355	J350
30 760	104-2097			4	6I-6356	6I-6354 (2)	6I-6355	J350		
36 915	132-8418			5	6I-6356	6I-6354 (3)	6I-6355	J350		
Excavation	42 1070		6I-5193	5	6I-6356	6I-6354 (3)	6I-6355	J350		
	32 810		9C-3260	3	159-0466	159-0464	159-0465	J450		
	48 1220		104-3436	6	6I-6356	6I-6354 (4)	6I-6355	J350		
	54 1370		6I-5248	6	6I-6356	6I-6354(4)	6I-6355	J350		
	60 1525		108-3569	7	6I-6356	6I-6354 (5)	6I-6355	J350		
	47 1194		109-8554	5	6I-6406	6I-6404 (3)	6I-6405	J400		
	53 1346		7Y-7567	5	6I-6406	6I-6404 (3)	6I-6405	J400		

① Consists of base edge and adapters.

② Base Edge only.

Number in parentheses () after the part number indicates the quantity required.

Ground Engaging Tools - Excavator Buckets

MODEL	BUCKET TYPE	BUCKET WIDTH (in) (mm)	BASE EDGE ASSY ①	NUMBER OF TEETH	ADAPTERS			TIP SIZE	
					(lh)	(ctr)	(rh)		
231D (cont.)	Excavation	55	9C-2930	5	6I-6356	6I-6354 (3)	6I-6355	J350	
		56	109-8555	5	6I-6406	6I-6404 (3)	6I-6405	J400	
		61	108-3569	7	6I-6356	6I-6354 (5)	6I-6355	J350	
		93	4V-5751	6	8E-4466 (3)		8E-4465 (3)	J460	
		83	6W-0875	6		159-0464			J460
		82	6W-3658	6		1U-1304			J300
		84	6W-1362	6	8E-2466 (3)			8E-2465 (3)	J460
		48	4E-8449	4	6I-6556	6I-6554 (2)		6I-6555	J550
		30	105-2532	3	159-0466	159-0464		159-0465	J460
		36	9C-4310	4	159-0466	159-0464 (2)		159-0465	J460
235 Front Shovel	General Purpose	61	108-3569	7	6I-6356	6I-6354 (5)	6I-6355	J350	
		93	4V-5751	6	8E-4466 (3)		8E-4465 (3)	J460	
		83	6W-0875	6		159-0464			J460
		82	6W-3658	6		1U-1304			J300
		84	6W-1362	6	8E-2466 (3)			8E-2465 (3)	J460
		48	4E-8449	4	6I-6556	6I-6554 (2)		6I-6555	J550
		30	105-2532	3	159-0466	159-0464		159-0465	J460
		36	9C-4310	4	159-0466	159-0464 (2)		159-0465	J460
		42	9C-4311	4	159-0466	159-0464 (2)		159-0465	J460
		48	105-3569	5	159-0466	159-0464 (3)		159-0465	J460
245	Excavation	60	2V-6891	6	8E-2466+	159-0464 (4)	8E-2465+	J460	
		54	9C-3890	5	159-0466	159-0464 (3)	159-0465	J460	
		63	9U-4413	5	159-0466	159-0464 (3)	159-0465	J460	
		66	9C-3954	6	159-0466	159-0464 (4)	159-0465	J460	
		71	9U-4423	6	159-0466	159-0464 (4)	159-0465	J460	
		69	9C-5770 ^②						
		34	9C-8653	3	159-0466	159-0464		159-0465	J460
		51	5V-5081	4		3G-9494 (2)			J550
		36	8K-4158	3	6I-6556	6I-6554		6I-6555	J550
		42	8R-0343	4	6I-6556	6I-6554 (2)		6I-6555	J550
245 Front Shovel	Excavation	48	8R-0783	4	6I-6556	6I-6554 (2)	6I-6555	J550	
		54	8R-0794	5	6I-6556	6I-6554 (3)	6I-6555	J550	
		68	8R-0981**	5	6I-6556	6I-6554 (3)	6I-6555	J550	
		75	4V-3372	6	6I-6556	6I-6554 (4)	6I-6555	J550	
		81	8R-0992	6	6I-6556	6I-6554 (4)	6I-6555	J550	
		93	104-7490	6	3G-9496 (3)		3G-9495 (3)	J460	
		83	9V-2321	6		6I-6554			J550
		82	9V-5067	6		1U-1354			J350
		84	103-4715	6	6I-2606 (3)			6I-8605 (3)	J550
									J225
245 Mass Excavation Hoe	General Purpose							J250	
E70B	Light Material								
E110B, E120B	Rock								

① Consists of base edge and adapters.

② Base Edge only.

Number in parentheses () after the part number indicates the quantity required.

Ground Engaging Tools - Excavator Buckets

MODEL	BUCKET TYPE	BUCKET WIDTH (in) (mm)	BASE EDGE ASY ①	NUMBER OF TEETH	(lh)	ADAPTERS (ctr)	(rh)	TIP SIZE
E180, E200B, EL200B	Trenching	24 625	9C-7381	3	7T-3306	9W-1304	7T-3305	J300
		30 775	9C-4307	4	7T-3306	9W-1304 (2)	7T-3305	J300
	Excavation	36 925	9C-4308	5	7T-3306	9W-1304 (3)		J300
		42 1075	100-4149	5		8E-9490 (5)	7T-3305	J300
		48 1225	9C-7287	6	7T-3306	9W-1304 (4)	7T-3305	J300
E180, E200B, EL200B (cont.) E240, E240B, EL240B	Extreme Service Excavation	54 1375	9C-7315	6	7T-3306	9W-1304 (4)	7T-3305	J300
		42 1075	9C-8019	5	6I-6356	6I-6354 (3)	6I-6355	J350
	Trenching	30 775	105-2761	3	6I-6406	6I-6404	6I-6405	J400
		36 925	6I-5280	5	6I-6356	6I-6354	6I-6355	J350
		42 1075	6I-5193	5	6I-6356	6I-6354	6I-6355	J350
E300	Excavation	48 1227	104-3436	6	6I-6356	6I-6354 (4)	6I-6355	J350
		54 1377	9C-2930	6	6I-6356	6I-6354 (4)	6I-6355	J350
	Light Excavation (Utility)	66 1675	8R-2662 ^②					
	Extreme Service Excavation	60 1525	108-3569	7	6I-6356	6I-6354 (5)	6I-6355	J350
		24 610	104-2096	3	6I-6356	6I-6354	6I-6355	J350
E300B, EL300B	Trenching	36 925	105-2533	3	159-0466	159-0464	159-0465	J460
		42 1075	104-5747	5	159-0466	159-0464	159-0465	J460
	Excavation	51 1300	9C-4312	5	159-0466	159-0464 (3)	159-0465	J460
		30 760	4E-8636	3	6I-6406	6I-6404	6I-6405	J460
		33 835	105-2532	3	159-0466	159-0464	159-0465	J460
Extreme Service Trenching	42 1070	9C-3763	4	159-0466	159-0464 (2)	159-0465	J460	
	Excavation	59 1499	8R-2710	6	159-0466	159-0464 (4)	159-0465	J460

① Consists of base edge and adapters.

② Base Edge only.

Number in parentheses () after the part number indicates the quantity required.

Ground Engaging Tools - Excavator Tips

Tips

Cat excavator bucket tips are side pinned for excellent tip retention and quick, easy tip changing. The pin hole is located through the tip sides which are the areas of least wear.



Long Tip

- For use in most jobs.



Short Tip

- Provides more strength.
- Use to prevent breakage.



Utility Tip

- For use in lighter duty applications (J200 only).



Wide Tip

- Provides less penetration.
- Provides a cleaner floor and less spillage.



Penetration Tip

- Provides better penetration.
- Contains less wear material.



Penetration Long Life Tip

- Increases wear life in moderate to high impact applications.
- Enhances penetration due to self-sharpening tip.
- Includes arm strips.

Ground Engaging Tools - Excavator Tips



Penetration Plus Tip

- Provides a good combination of strength and wear life.
- For use where penetration and increased wear life are desired.

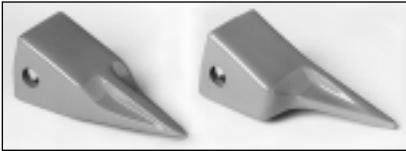

Sharp Corner Tip / Sharp Center Tip

- Provides the best penetration.
- Contains the least wear material.



Twin Sharp Tip

- For use for severe digging in rock and frost.
- Use in combination with sharp tips.



Long Sharp Tip

- Provides more wear material than standard sharp tip.
- For use when penetration is the primary concern.



Heavy Duty Long Tip

- Provides more wear material and greater strength than long tip.
- Has a streamlined-profile for better penetration.



Heavy Duty Long Life Tip

- Contains ARM which is positioned to increase wear life and penetration.
- Not for use in extreme impact applications.

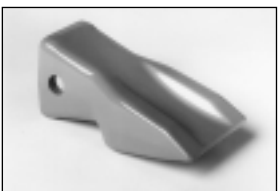

Heavy Duty Abrasion Tip

- Contains greater wear material.
- Not for use in high impact applications.

Ground Engaging Tools - Excavator Tips

J Family Identification

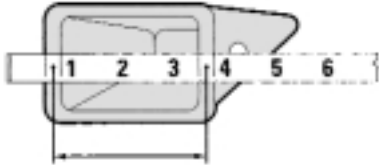

To identify the tip or adapter family, place a tape measure across the back of the tip at the midpoint of the side walls. For example:

3.0" (76.20 mm) measurement = J300 Family

3.5" (88.90 mm) measurement = J350 Family

5.5" (139.70 mm) measurement = J550 Family

In addition, the second and third to last locations in the part number often times refer to the J size.

Example: 9W-8551 = J550 Family

Tip Chart

	J200	J225	J250	J300	J350	J400	J460	J550	J600	J700
Long	1U-3202	6Y-3222	1U-3252	1U-3302	1U-3352	7T-3402	9W-8452	9W-8552	6I-6602	4T-4702
Short		6Y-6221	1U-3251	1U-3301	1U-3351	7T-3401	9W-8451	9W-8551	6I-6601	
Utility	7T-8202									
Wide	109-9200		3G-8250	107-3300	107-3350	107-3400	107-3450	107-3550		
Penetration	1U-3209	6Y-8229	9J-4259	9J-4309	9J-4359	6Y-7409	9W-8459	9W-8559	7I-7609	4T-4709
Penetration Long Life				125-8309	119-9359	124-7409	116-7459	113-0559	119-9609	
Penetration Plus				183-5300	168-1359	168-1409	159-0459	159-0559	159-0607	171-1709
Sharp Corner	9W-8208	6Y-7228	9W-8258	9W-8308	9W-2358	6Y-5408	6I-8458	6I-8558	107-8608	
Sharp Center	9W-8209	6Y-7229	9W-8259	9W-8309	9W-2359	6Y-5409	7T-8459	9W-6559	107-8609	
Twin Sharp	135-8208	135-8228	135-8258	135-9308	135-9357	135-9408	138-6458	138-6558	135-9608	
Long Sharp				168-1300	168-1350	159-0400	159-0450	159-0550	159-0600	136-8700
Heavy Duty Long		8E-4222	9N-4252	9N-4302	9N-4352	8E-4402	9N-4452	9N-4552	7Y-0602	9U-9702
Heavy Duty Long Life			135-8252	125-8302	135-9352	116-7402	101-9054	101-9055	107-8602	107-2001
Heavy Duty Abrasion		6Y-6223	9N-4253	9N-4303	9N-4353	7T-3403	9N-4453	6Y-2553	6I-6603	9U-9703
Standard Pin	8E-6208									
Standard Retainer	8E-6209									
Heavy Duty Pin		132-4762	132-4763	132-4766	114-0358	116-7408	114-0468*	107-3378	113-9608	113-4708
Heavy Duty Retainer		149-5733	149-5733	149-5733	114-0359	116-7409	107-3469*	107-8559	113-9609	113-4709

* Some older models have a 0.75" (19 mm) pin diameter, instead of the current 0.875" (22 mm) pin diameter. For those older models which have the 0.75" (19 mm) pin diameter, use a 6Y-2527 pin and a 8E-6359 retainer.

Ground Engaging Tools - Excavator Sidecutters

Sidecutters

- Increase bucket width and capacity.
- Protect bucket sides.
- Improve sidebar penetration.



Blade Type 1 Sidecutter

- For use in most conditions.



One Piece Sidecutter

- For use in most soil conditions.
- Widens bite width.
- Provides good protection to bucket sides.

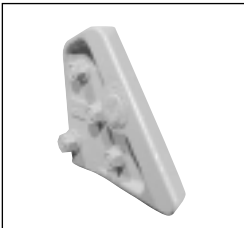

Heavy Duty Sidecutter

- For use in tough digging conditions.
- Contains more wear material and covers more of the sidebar for enhanced protection.

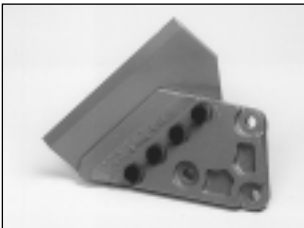

Combination Blade Sidecutter

- For use in light to moderate conditions.



Tooth Type Sidecutter

- For use in tough conditions.
- Uses the same tips as the cutting edge.



Strike-Off Sidecutter

- For use in all conditions.
- Does not add width to bucket.

Ground Engaging Tools - Excavator Sidecutters

Sidecutters

TYPE	PART NUMBER		BOLT	NUT	WASHER	TIP	PIN	RETAINER
	(lh)	(rh)						
B Linkage								
One Piece	096-4747	096-4748	8T-0664 (8)	7X-0851 (8)				
Heavy Duty	112-2488	112-2487	1D-4635 (8)	2J-3507 (8)	3K-5234 (8)			
C Linkage, D Linkage, S Linkage								
One Piece	7Y-0358	7Y-0357	6I-6371 (6)	2J-3507 (6)				
Strike-Off	9J-9540	9J-9539		2J-3507 (6)				
— Bolt	1J-6762 (4)	6I-6371 (4)						
Blade Type 1	8J-9614	8J-9615	6I-6371	2J-3507				
Heavy Duty	112-2488	112-2487	1D-4635 (8)	2J-3507 (8)	3K-5234 (8)			
Combination	8J-9614	8J-9615						
— Blade		4T-2886 (2)						
— Bolt	1J-6762 (8)	6I-6371 (6)						
— Nut	2J-3506 (8)	2J-3507 (6)						
Tooth	8J-4952	8J-4951	4F-4042 (6)	2J-3507 (6)		1U-3352 (2)		
E Linkage								
Strike-Off		8J-5188 (2)	1D-4637 (4)	2J-3507 (4)	5P-8250 (1)			
Blade Type 1	8J-9826	8J-9825	8H-5772 (1)	2J-3507 (1)	5P-8250 (1)			
Combination	8J-9826	8J-9825			5P-8250 (1)			
— Blade		4T-6664 (2)						
— Bolt		8H-5772						
— Nut		2J-3507						
Tooth	8J-4948	8J-4947	8H-5772 (1)	2J-3507 (1)	5P-8250 (1)	9W-8552 (2)		
F Linkage, G Linkage								
Strike-Off	8J-5188	8J-5188	7Y-1136 (1)	2J-3507 (1)	3K-5234 (1)			
Blade Type 1	8J-9826	8J-9825	7Y-1136 (1)	2J-3507 (1)	3K-5234 (1)			
Heavy Duty	112-2486	112-2485	1D-4637 (10)	2J-3507 (10)	3K-5234 (10)			
Heavy Duty	167-3836	167-3837	1D-4637 (10)	2J-3507 (10)	3K-5234 (10)			
Combination	8J-9826	8J-9825			3K-5234 (1)			
— Blade		4T-6664 (2)						
— Bolt	4J-9208	7Y-1136						
— Nut		2J-3507						
Tooth	8J-4948	8J-4947	7Y-1136 (1)	2J-3507 (1)	3K-5234 (1)	9W-8552 (2)	6Y-8558 (2)	8E-5559 (2)
H Linkage, J Linkage								
Strike-Off		8J-5188 (2)	1D-4637 (4)	2J-3507 (4)	5P-8250 (1)			
Blade Type 1	8J-9826	8J-9825	8H-5772 (1)	2J-3507 (1)	5P-8250 (1)			
Combination	8J-9826	8J-9825			5P-8250 (1)	9W-8552 (2)		
— Blade		4T-6664 (2)						
— Bolt		8H-5772						
— Nut		2J-3507						
Tooth	8J-4948	8J-4947	8H-5772 (1)	2J-3507 (1)	5P-8250 (1)	9W-8552 (2)		
V Linkage								
Heavy Duty	167-3836	167-3837	1D-4637 (10)	2J-3507 (10)	3K-5234 (10)			
Heavy Duty	112-2486	112-2486	1D-4637 (10)	2J-3507 (10)	3K-5234 (1)			

Ground Engaging Tools - Excavator Sidecutters

Sidecutters

TYPE	PART NUMBER		BOLT	NUT	WASHER	TIP	PIN	RETAINER
	(lh)	(rh)						
215								
Blade Type 1	9J-1856	9J-1855	4F-7827 (6)	2J-3506 (6)				
Strike-Off	9J-1858	9J-1857	4F-7827 (6)	2J-3506 (6)				
Combination	9J-1856	9J-1855	4F-3656 (8)	1D-4720 (8)				
— Blade	4T-2964	9J-0371						
— Bolt	4F-7827 (6)	4F-7827 (6)						
— Nut	1D-4720 (6)	2J-3506 (6)						
Tooth	9J-1876	9J-1875	4F-3672 (6)	2J-3506 (6)		1U-3302 (2)	107-3308 (2)	8E-6259 (2)
225								
Blade Type 1	8J-9614	8J-9615	4F-4042 (6)	2J-3507 (6)				
Strike-Off	9J-9540	9J-9539	1J-5607 (4)	2J-3507 (4)				
Combination	8J-9614	8J-9615	1J-6762 (8)	2J-3506 (8)				
— Blade		4T-2886 (2)						
— Bolt	4F-4042 (6)	1J-6762 (8)						
— Nut	2J-3507 (6)	2J-3506 (8)						
Tooth	8J-5186	8J-5185	4F-4042 (6)	2J-3507 (6)		1U-3352 (2)	8E-6258 (2)	8E-6259 (2)
235								
Blade Type 1	8J-9614	8J-9615	4F-4042 (6)	2J-3507 (6)				
Strike-Off	9J-9540	9J-9539	1J-5607 (4)	2J-3507 (4)				
Combination	8J-9614	8J-9615	1J-6762 (8)	2J-3506 (8)				
— Blade		4T-2886 (2)						
— Bolt	4F-4042 (6)	1J-6762 (8)						
— Nut	2J-3507 (6)	2J-3506 (8)						
Tooth	8J-5186	8J-5185	4F-4042 (6)	2J-3507 (6)		9W-8452 (2)	8E-0468 (2)	8E-8469 (2)
245								
Blade Type 1	8J-9826	8J-9825	4J-9208 (1)	2J-3507 (1)	5P-8250 (1)			
Strike-Off	8J-5188	8J-5188	1J-5607 (4)	2J-3507 (4)				
Combination	8J-9826	8J-9825	4J-9208 (1)	2J-3507 (1)	5P-8250 (1)			
— Blade		4T-6664 (2)						
— Bolt		4J-9208						
— Nut		2J-3507						
Tooth	8J-4948	8J-4947	4J-9208 (1)	2J-3507 (1)	5P-8250 (1)	9W-8552 (2)	6Y-8558 (2)	8E-5559 (2)
E70B								
One Piece	7Y-0739	7Y-0738	096-7074	093-7676				
E110B								
One Piece	7Y-0203	7Y-0204	096-7074	093-7676				
E120B								
One Piece	7Y-0203	7Y-0204	096-7074	093-7676				
E140B								
One Piece	7Y-0203	7Y-0204	096-7074	093-7676				
E200B								
Blade Type 1	9J-1856	9J-1855	4F-7827 (6)	2J-3506 (6)				
Strike-Off	9J-1858	9J-1857	4F-7827 (6)	2J-3506 (6)				

Ground Engaging Tools - Excavator Sidecutters and Protectors

Sidecutters

TYPE	PART NUMBER		BOLT	NUT	WASHER	TIP	PIN	RETAINER
	(lh)	(rh)						
E200B (cont.)								
Combination	9J-1856	9J-1855	4F-3656 (8)	1D-4720 (8)				
— Blade	4T-2964	9J-0371						
— Bolt	4F-7827 (6)	4F-7827 (6)						
— Nut	1D-4720 (6)	2J-3506 (6)						
Tooth	9J-1876	9J-1875	4F-3672 (6)	2J-3506 (6)		1U-3302 (2)	107-3308 (2)	8E-6259 (2)
E240B								
Blade Type 1	8J-9614	8J-9615	4F-4042 (6)	2J-3507 (6)				
Strike-Off	9J-9540	9J-9539	1J-5607 (4)	2J-3507 (4)				
Combination	8J-9614	8J-9615	1J-6762 (8)	2J-3506 (8)				
— Blade		4T-2886 (2)						
— Bolt	4F-4042 (6)	1J-6762 (8)						
— Nut	2J-3507 (6)	2J-3506 (8)						
Tooth	8J-5186	8J-5185	4F-4042 (6)	2J-3507 (6)		1U-3352 (2)	8E-6258 (2)	8E-6259 (2)
E300B								
Blade Type 1	8J-9614	8J-9615	4F-4042 (6)	2J-3507 (6)				
Strike-Off	9J-9540	9J-9539	1J-5607 (4)	2J-3507 (4)				
Combination	8J-9614	8J-9615	1J-6762 (8)	2J-3506 (8)				
— Blade		4T-2886 (2)						
— Bolt	4F-4042 (6)	1J-6762 (8)						
— Nut	2J-3507 (6)	2J-3506 (8)						
Tooth	8J-5186	8J-5185	4F-4042 (6)	2J-3507 (6)		9W-8452 (2)	8E-0468 (2)	8E-8469 (2)

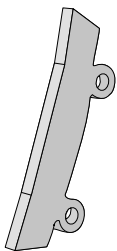

- Use in rock conditions.
- Protect bucket sidebar.

Hex Sidebar Protectors

BUCKET FAMILY	ONE PIECE	TWO PIECE	PIN	RETAINER
B, S, C, D		112-2489	112-2490	149-5733
E, F, G, V (Early)	112-2494		132-0998	149-5733
E, F, G, V, (New)		166-2877	132-0998	149-5733
W	125-0800		8E-4708	4T-4707
J		112-2492	132-1008	149-5733
350, 375 (Early)	1U-0740		133-0738	107-8559
330B, 325B, 322B, 320B	8J-4143		9J-8441	8E-8559



GROUND ENGAGING TOOLS - LOADER

Buckets	278
Edges	285
Segments	291
Wear Plates	296
Sidebar Protectors and Corner Protectors	300
Tips	301
Adapters	304

Ground Engaging Tools - Loader Buckets

Loader Buckets

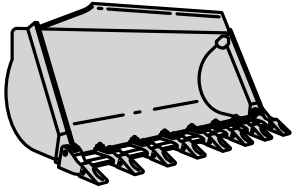

General Purpose Excavating Bucket

- Uses shell tine construction and can be equipped with a corner guard system.
- For use in excavating materials that require breakout force as well as stockpiling material.

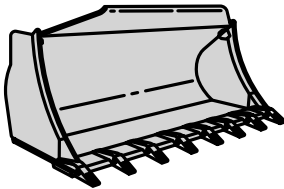

General Purpose Penetration Bucket

- Provides maximum penetration due to flush-mounted teeth, a sharp base edge, and sharply curved side bars.
- For use in applications where a smooth level cut is needed.

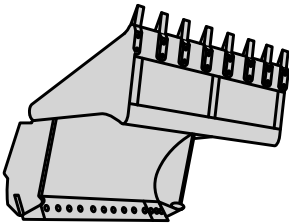

Multi-Purpose Bucket

- Provides more dump clearance and grabbing capabilities due to its movable clam.
- For use in general loading.

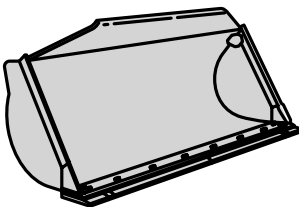

Material Handling Bucket

- Designed with a flat bottom and weld-on wear strips.
- Available with bolt-on adapters, adapters and segments, or bolt-on cutting edges.

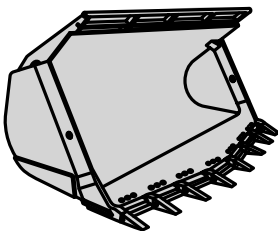

Rock Bucket

- Available with straight or spade edges.
- Straight edges provide a higher breakout force and an increased dump clearance.
- Spade edges provide better penetration.
- Available with teeth, without teeth, with teeth and bolt-on segments, or with bolt-on cutting edges.
- For use in mining or quarry applications.

Ground Engaging Tools - Loader Buckets

Loader Buckets

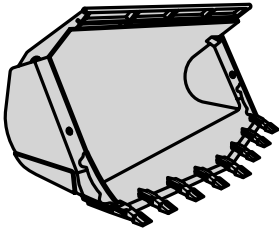

Modulok Rock Bucket

- Features quick change wear surfaces and DH-3 heavy duty long tips.

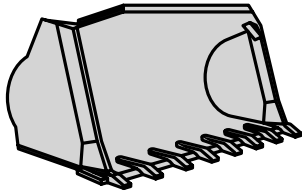

Utility Bucket

- For use in handling materials of varying shapes — such as boxes, crates, bundles, drums, and loose stockpiled material.
- For use with Integrated Toolcarriers.

Ground Engaging Tools - Loader Buckets

MODEL	BUCKET WIDTH (in)	BUCKET WIDTH (mm)	EDGE TYPE	UNIVERSAL BASE EDGE	BASE** EDGE	BASE* EDGE ASSY.	BUCKET CORNER (lh)	BUCKET / SIDEBAR (rh)	ONE BOLT BUCKET CORNER (lh)	ONE BOLT BUCKET CORNER (rh)	TWO BOLT BUCKET CORNER (lh)	TWO BOLT BUCKET CORNER (rh)	NUMBER OF TEETH	TIP SIZE
910, 914G	82.6	2098	Straight	5G-2809					5G-2806	5G-2807			7	J200
	85.1	2162	Straight	5G-6133	5G3085				5G-2806	5G-2807			7	J200
916, 924F, 926, 928	89.5	2273	Straight	5G-8763					5G-2806	5G-2807			7	J200
	94.0	2388	Straight	5G-8342					5G-2806	5G-2807			8	J200
920, 930	96.0	2438	Straight		5G-8912	5G-8911	5G-5769	5G-5770					8	J200
	93.6	2377	Straight	9V-6572	5V-4670				4V-1545	4V-1544	6I-8310	6I-8311	8	J250
928F, 928G	96.0	2438	Straight			9V-9755	4V-8286	4V8285					8	J250
	95.3	2421	Straight	6W-2984					4V-1545	4V-1544	6I-8310	6I-8311	8	J250
924G	96.0	2438	Straight		1V-3916	1V-5171a	4V-8286	4V-8285					9	J250
	99.7	2532	Straight	4E-0659					4V-1545	4V-1544	6I-8310	6I-8311	8	J250
931, 935	102.0	2591	Straight		4E-2483	4E-2482	4V-8286	4V-8285					8	J250
	85.1	2162	Straight	5G-6133	5G-3085				5G-2806	5G-2807			7	J200
939	92.4	2347	Straight		5G-3477				5G-2806	5G-2807			7	J200
	72.2	1834	Straight		5G-2808				5G-2806	5G-2807			8	J200
931, 933, 935	77.5	1969	Straight	8Y-4738	5G-8467				5G-2806	5G-2807			8	J225
	104.2	2647	Straight	6W-2985	8V-1825				4V-1545	4V-1544	6I-8310	6I-8311	8	J250
936, 936E	107.5	2731	Straight		9V-9072	9V-9521							8	J250
	109.2	2477	Straight			106-3192							8	J250
938F, 938G	107.2	2723	Straight	110-4712					4V-1545	4V-1544	6I-8310	6I-8311	8	J250
	105.9	2690	Straight	105-2345					4V-1545	4V-1544	6I-8310	6I-8311	8	J250
941, 951	109.2	2774	Straight			106-3192							8	J250
	85.0	2159	Straight	8Y-8763					4V-1545	4V-1544	6I-8310	6I-8311	8	J250
943	79.8	2027	Straight	6W-2977					4V-1545	4V-1544	6I-8310	6I-8311	8	J250
	82.0	2083	Straight		9K-8471	1V-0074***	4V-8286	4V-8285					8	J250
944, 950	93.6	2377	Straight	9V-6572	5V4670				4V-1545	4V-1544	6I-8310	6I-8311	8	J250
	82.1	2086	Straight	9V-6571	4V-8335				4V-1545	4V-1544	6I-8310	6I-8311	8	J350
939	85.0	2156	Straight		9V-5110	9V-5111	4V-8286	4V-8285					8	J250
	87.0	2210	Straight	9V-6570	4V-8850				4V-1545	4V-1544	6I-8310	6I-8311	8	J250
943	88.8	2256	Straight	6W-2976	8V-7453				4V-1545	4V-1544	6I-8310	6I-8311	8	J250
	90.0	2285	Straight		1V-9077	9V-5116	4V-8286	4V-8285					8	J250
944, 950	95.2	2419	Straight	6W-2986					5V-7395	5V-7396	8E-5302	8E-5303	8	J300
	96.0	2438	Straight		1V-3916	9K-8665a	8K-6456	8K-6455					9	J300
950	103.3	2624	Straight	6W-2987					5V-7395	5V-7396	8E-5302	8E-5303	8	J300
	105.8	2687	Straight		1V-3915	9K-8664	4V-8668	4V-8667					8	J300
950	104.2	2647	Straight	6W-2985	8V-1825				5V-7395	5V-7396	8E-5302	8E-5303	8	J300

** Does not accept segments.
 Note: Universal base edge allows use of teeth and segments or bolt-on edges.
 a Consists of edge and seven adapters.

* Consists of edge and adapters.
 *** Consists of edge and six adapters.
 Number in parentheses () after the part number indicates the quantity required.

Ground Engaging Tools - Loader Buckets

MODEL	BUCKET WIDTH		EDGE TYPE	UNIVERSAL BASE EDGE	BASE** EDGE	BASE* EDGE ASSY.	BUCKET CORNER / SIDEBAR		ONE BOLT BUCKET CORNER (lh)	TWO BOLT BUCKET CORNER (rh)	NUMBER OF TEETH	TIP SIZE
	(in)	(mm)					(lh)	(rh)				
950 B,E,F	111.0	2819	Spade	6W-2973	9C0967	6W-9879**	6W-3468	6W-3468			8	J350
	108.0	2744	Straight		6W-4598	6W-4599					8	J300
960 B,E,F	107.7	2736	Straight	9V-6573	5V-4696			5V-1783	5V-1784	8E-5301	8	J300
	108.0	2744	Straight		5V-7410			5V-1783	5V-1784	8E-5301	8	J300
950G, 962G	115.5	2934	Straight	141-4847				5V-1783	5V-1784	8E-5301	8	J300
	117.0	2973	Spade		142-9406	141-8824	6W-3468	6W-3468			8	J350
953	117.5	2984	Spade		141-8823		6W-3468	6W-3468				
	87.0	2210	Straight	9V-6570	4V-8850			4V-1545	4V-1544	6I-8310	8	J250
955	90.0	2285	Straight		1V-9077	9V-5116	4V-8286	4V-8285			8	J250
	93.6	2377	Straight	9V-6572	5V-4670		4V-8286	4V-8285	4V-1545	6I-8310	8	J250
963	96.0	2438	Straight		1V-3916	9V-5117	4V-8286	4V-8285			8	J250
	88.5	2248	Straight		9K-8461		8K-7526	8K-7525			8	J300
960F	89.3	2268	Straight	6W-2978					5V-1784	8E-5301	8	J300
	90.0	2286	Straight		1V-9077		4V-8668	4V-8667			8	J300
966C	96.0	2438	Straight		5V-7263				5V-1784	8E-5301	8	J300
	107.7	2736	Straight	9V-6573	5V4696				5V-1783	8E-5301	8	J300
966D, E, F	108.0	2743	Straight		5V-7410				5V-1783	8E-5301	8	J300
	119.4	3032	Straight	9V-6575	7V-1490				5V-1783	8E-5301	8	J350
966G, 972G	89.6	2276	Straight	6W-2979	4V-4958				4V-7174	8E-5311	8	J300
	92.3	2345	Straight		9V-5340	9V-5341	4V-8668	4V-8667	5V-1784	8E-5301	8	J300
966C	97.4	2474	Straight	6W-2980	4V-3174				5V-1784	8E-5301	8	J300
	98.7	2507	Straight	8Y-6263					5V-2772	8E-5320	8	J350
966C	100.5	2553	Straight		9V-5328	9V-5327	4V-8668	4V-8667			8	J300
	112.0	2840	Straight	6W-2989					5V-2773	8E-5321	8	J300
966D, E, F	112.8	2864	Straight	6W-2990					5V-2773	8E-5321	8	J300
	115.0	2921	Straight		1V-3917	2V-3583	1V-8664	1V-8664			7	J350
966G, 972G	115.0	2921	Straight		7V-6844				4V-7174	8E-5310	8	J350
	119.4	3032	Straight	9V-6575	7V-1490				4V-7174	8E-5310	8	J350
966G, 972G	119.7	3040	Straight		7V-0912	6W-5520			4V-7174	8E-5310	8	J350
	121.5	3086	Spade	6W-2993	9V-0170	9V-0176	8K-7526	8K-7525			8	J350
966G, 972G	121.5	3086	Spade	6W-2993		2Q-2924	8K-7526	8K-7525			8	J350
	124	3150	Straight	9V-6575	7V-1490				4V-7174	8E-5310	8	J350
966G, 972G	128	3252	Spade	148-6915		148-6914					8	J350
	130	3306	Spade		154-1604							
966G, 972G	130.4	3311	Straight	7I-3015					4V-7174	8E-5310	8	J350

* Consists of edge and adapters.
 Number in parentheses () after the part number indicates the quantity required.
 ** Does not accept segments.
 Note: Universal base edge allows use of teeth and segments or bolt-on edges.

Ground Engaging Tools - Loader Buckets

MODEL	BUCKET WIDTH (in)	BUCKET WIDTH (mm)	EDGE TYPE	UNIVERSAL BASE EDGE	BASE** EDGE	BASE* EDGE ASSY.	BUCKET CORNER (lh)	BUCKET / SIDEBAR CORNER (rh)	ONE BOLT BUCKET CORNER (lh)	ONE BOLT BUCKET CORNER (rh)	TWO BOLT BUCKET CORNER (lh)	TWO BOLT BUCKET CORNER (rh)	NUMBER OF TEETH	TIP SIZE
970	115.5	2934	Straight	7I-3631					4V-7174	4V-7175	8E-5310	8E-5311	8	J350
	119.4	3032	Straight	9V-6575	7V-1490				4V-7174	4V-7175	8E-5310	8E-5311	8	J350
973	126.0	3200	Straight	7I-3015					4V-7174	4V-7175	8E-5310	8E-5311	8	J350
	102.8	2610	Straight	6W-2982					4V-7174	4V-7175	8E-5310	8E-5311	8	J350
	105.9	2690	Straight		9V-5287	9V-5288	6W-2454	6W-2453					8	J350
	106.7	2710	Straight	5G-7304	5G-7303				4V-7174	4V-7175	8E-5310	8E-5311	8	J350
977	112.1	2847	Straight	6W-2981					4V-7174	4V-7175	8E-5310	8E-5311	8	J350
	115.5	2934	Straight		9V-5283	9V-5284	6W-2454	6W-2453					8	J350
	106.5	2705	Spade	6W-2994			8K-7526	8K-7525					7	J350
	106.5	2705	Spade		9V-0171	9V-0178	8K-7526	8K-7525					8	J350
980A, 980B	96.0	2438	Straight	6W-2983					4V-7174	4V-7175	8E-5310	8E-5311	8	J350
	98.0	2489	Straight		9K-8472	1V-9018***	1V-8664	1V-8664					8	J350
	112.8	2864	Straight		7V-0898				4V-7174	4V-7175	8E-5310	8E-5311	8	J350
	128.8	3270	Straight	6W-2991					7V-4180	7V-4181	6I-8250	6I-8249	8	J350
980C, 980F	129.0	3277	Spade		8V-9580	8V-9586	2V-6299	2V-6299					8	J350
	130.8	3322	Straight		7V-0909		7V-9270	7V-9271					8	J350
	130.8	3322	Straight	9V-6574	7V-4188				7V-4180	7V-4181	6I-8250	6I-8249	8	J350
	129.4	3286	Straight		2V-6118		2V-6299	2V-6299					8	J350
983	132.5	3366	Spade		8V-9581	9V-0233	3V-7197	3V-7198					8	J350
	132.5	3366	Spade	9V-3561		4E-6807	3V-7197	3V-7198					8	J350
	132.5	3366	Spade	9V-3561			7K-9310	7K-9309						
	132.7	3371	Spade	9V-3561		4Q-6806	2V-4315	2V-4314					8	J460
980F,980G	134.0	3404	Straight	11I-9770							6I-8250	6I-8249	8	J400
	137.5	3493	Spade	113-9942		126-6539	145-6977	145-6977					8	J400
	137.5	3493	Spade		123-1396	126-6540	145-6977	145-6977					8	J400
	129.0	3277	Spade		8V-9591	137-6263	3V-3311	3V-3310					8	J460
988,988B	128.7	3270	Straight		8K-5056		7K-9310	7K-9309					8	J460
	140.2	3561	Straight	4E-6085					7V-4180	7V-4181	6I-8250	6I-8249	8	J460
	143.5	3645	Straight		3V-0187		4E-5873	4E-5873						
	143.5	3645	Spade		8V-9585	116-7206**	145-6984	145-6984					8	J460
988F	143.5	3645	Spade	8R-4649		116-7201	145-6984	145-6984					8	J460
	143.5	3645	Straight	9C-2932		2Q-1640	7K-9310	7K-9309					8	J460
	143.5	3645	Straight		9V-0232	4E-0056	7K-9310	7K-9309					8	J460
	148.5	3772	Straight		2Q-3133	2Q-3132	2Q-3137	2Q-3137					8	J460
988F	145.5	3696	Straight	9U-3748					7V-4180	7V-4181	6I-8250	6I-8249	8	J460

* Consists of edge and adapters.
 Number in parentheses () after the part number indicates the quantity required.
 *** Consists of edge and six adapters.
 ** Does not accept segments.
 Note: Universal base edge allows use of teeth and segments or bolt-on edges.

Ground Engaging Tools - Loader Buckets

MODEL	BUCKET WIDTH		EDGE TYPE	UNIVERSAL BASE EDGE	BASE** EDGE	BASE* EDGE ASSY.	BUCKET CORNER / SIDEBAR		ONE BOLT BUCKET CORNER		TWO BOLT BUCKET CORNER		NUMBER OF TEETH	TIP SIZE	
	(in)	(mm)					(lh)	(rh)	(lh)	(rh)	(lh)	(rh)			
988F (cont.)	148.5	3772	Spade			132-3116	145-6984	145-6984					8	J460	
	148.5	3772	Spade		133-0821	133-0820	145-6984	145-6984					8	J460	
	148.5	3772	Spade		9U-4713		4E-6474	4E-6474					8	J460	
	148.5	3772	Spade	4C-7616		2Q-7060	145-6987	145-6987					8	J460	
	148.5	3772	Spade			133-0818	4E-8106	4E-8106					8	J550	
	148.5	3772	Spade	146-6302		144-0106	144-0514	144-0514					8	J550	
	148.5	3772	Straight	4E-8112		116-7204	145-6981	145-6981					8	J460	
	148.5	3772	Straight	4E-8112		4E8111	4E-8106	4E-8106					8	J460	
	988G	148.5	3696	Straight	183-5190					7V-4180	7V-4181	6I-8250	6I-8249	8	J460
		149.6	3800	Straight	156-1039		156-1040	193-1756	193-1756					8	J460
149.6		3800	Spade	136-6176		136-6175	168-6529	168-6529					8	J460	
152.0		3862	Spade	2Q-7018		2Q-7019	193-8221	193-8221					7	J550	
153.5		3900	Spade	195-0411		195-0410	178-3702	178-3702					8	J460	
156.7		3980	Spade	156-6388		156-6391	178-3702	178-3702					8	J460	
175.5		4458	Spade	4E-9915		112-2119	145-6990	145-9660					8	J550	
175.5		4458	Spade		151-5980		145-6989	145-6989							
175.5		4458	Spade		101-9188	112-2118	145-6990	145-6990					8	J550	
175.5		4458	Straight	101-9186		112-2120	145-6990	145-6990					8	J550	
992, 992B	175.5	4458	Straight		101-9186		145-6989	145-6989							
	175.5	4458	Straight			111-9049	145-6992	145-6992					8	J550	
	168.8	4288	Straight		9V-0009	9V-0009	3V-3894	3V-3893					8	J550	
	181.0	4597	Spade		9V-4370	9V-4371	3V-3240	3V-3239					8	J550	
	187.0	4750	Spade	4E-6462		112-2122	145-6995	145-6995					8	J550	
	187.0	4750	Spade		9V-0005	9V-0014	9V-6132	9V-6132					8	J550	
	187.0	4750	Spade	4E-6462		4E-6464	145-6995	145-6995					8	J550	
	187.0	4750	Spade		9V-0006	9V-0013	4E-6386	4E-6386					8	J550	
	181.0	4597	Straight		3V-3890		3V-3894	3V-3893					8	J550	
	187.0	4750	Straight		9V-0007	9V-0010	5V-5403	5V-5403					8	J550	
992D	187.0	4750	Spade	9V-3566		112-2121	145-6995	145-6995					8	J550	
	187.0	4750	Spade	4E-6462		2Q-0318	4E-6387	4E-6387					8	J700	
	187.0	4750	Straight	9U-3486		112-2123	145-6997	145-6997					8	J550	
	189.9	4823	Spade		142-5790	112-8996	112-8996	112-8996					8	J600	
	189.9	4823	Spade		132-7091	112-8996	112-8996	112-8996					8	J550	
	189.9	4823	Spade		153-5621	112-9005	112-9005	112-9005					8	J700	
	190.6	4841	Spade		107-6763**	134-5906	134-5906	134-5906					8	J600	

* Consists of edge and adapters.
 Number in parentheses () after the part number indicates the quantity required.
 ** Does not accept segments.
 Note: Universal base edge allows use of teeth and segments or bolt-on edges.

Ground Engaging Tools - Loader Buckets

MODEL	BUCKET WIDTH (in)	BUCKET WIDTH (mm)	EDGE TYPE	UNIVERSAL BASE EDGE	BASE** EDGE	BASE* EDGE ASSY.	BUCKET CORNER (lh)	BUCKET / SIDEBAR (rh)	ONE BOLT BUCKET CORNER (lh)	TWO BOLT BUCKET CORNER (lh)	NUMBER OF TEETH	TIP SIZE
994	222.0	5640	Spade	101-5868		101-5857	101-9374	101-9373			8	J800
	222.0	5640	Spade	110-2339		110-2340	101-9374	101-9373			8	J800
	222.0	5640	Spade	121-2105		121-2104	121-2367	121-2364			8	J800
	222.0	5640	Spade	8X-0809		8X-0808	8X-0816	8X-0813			9	J700
	245.0	6220	Spade	101-5865		101-5856	101-9374	101-9373			9	J800
	245.0	6220	Spade	121-6660		121-6659	121-2367	121-2364			9	J800
	245.0	6220	Straight	101-6776		71-5848	101-6777	101-6777			9	J800
	222.0	5640	Straight	102-9914		102-9915	101-6777	101-6777			8	J800
IT12	85.1	2162	Straight	5G-6133	5G-3085				5G-2806	5G-2807	7	J200
			Penetration		5G-5764	5G-5763	5G-5769	5G-5770			8	J200
IT14G	94.0	2388	Straight	5G-8342					5G-2806	5G-2807	8	J200
	96.0	2438	Straight		5G-8912	5G-8911	5G-5769	5G-5770			8	J200
IT18, IT28	93.6	2377	Straight	9V-6572	5V-4670				4V-1545	4V-1544	8	J250
	96.0	2438	Straight			9V-9755	4V-8286	4V-8285		6I-8310	8	J250
	99.7	2532	Straight	4E-0659					4V-1545	4V-1544	8	J250
IT24F, IT28F	102.0	2591	Straight		4E-2483	4E-2482	4V-8286	4V-8285			8	J250
	104.2	2647	Straight	6W-2985	8V-1825				4V-1545	4V-1544	8	J250

* Consists of edge and adapters.

Number in parentheses () after the part number indicates the quantity required.

** Does not accept segments.

Note: Universal base edge allows use of teeth and segments or bolt-on edges.

Ground Engaging Tools - Loaders Edges

Bolt-On Edges

When penetration is not a problem, use bolt-on cutting edges. Bolt-on cutting edges:

- Increase base edge life up to five times over an unprotected base edge.
- Are quick and easy to replace.
- Increase bucket capacity.
- Provide smooth floor maintenance capability.
- Are made of DH-2 steel alloy and are hardened to 430-520 Brinell.

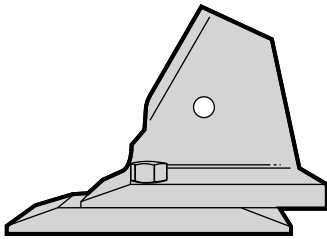

Standard Bolt-On Edges

- Reversible for a second wear life.

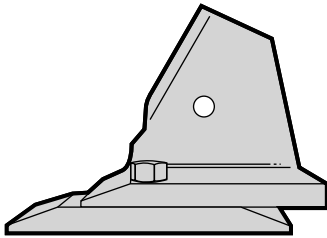

Heavy Duty Bolt-On Edges

- Provide at least 50% more wear material than standard bolt-on edges.
- Reversible for a second wear life.

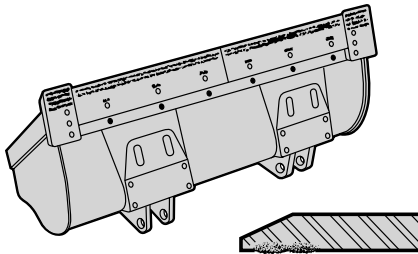

A.R.M. Bolt-On Edges

- Provide three to five times the wear life of standard bolt-on edges.
- For use in low to moderate impact applications where wear rates are high — such as in abrasive materials.

Ground Engaging Tools - Loader Edges

MODEL	BUCKET WIDTH (mm)		BUCKET TYPE	EDGE TYPE	BOLT-ON EDGE PART NUMBER					WASHER		
	(in)	(mm)			(left end)	(left center)	(center)	(right center)	(right end)			
910, 914G	82.6	2098	CGS	Straight End	4T-2914		4T-8796		4T-2914	4F-7827 (7)	2J-3506 (7)	
	85.1	2162	CGS	Straight End	4T-2914		4T-2913		4T-2914	4F-7827 (7)	2J-3506 (7)	
	89.5	2273	CGS	Straight End	4T-2914		9W-8694		4T-2914	4F-7827 (7)	2J-3506 (7)	
	94.0	2388	CGS	Straight End	4T-2914		9W-8620		4T-2914	4F-7827 (8)	2J-3506 (8)	
916, 924F, 926	93.6	2378	CGS	Straight End	4T-8091		1U-0295 (2)		4T-8091	1J-5607 (10)	2J-3507 (10)	
				Angled End	1U-1896		1U-0295 (2)		1U-1896	1J-5607 (10)	2J-3507 (10)	
920, 930	95.3	2421	CGS	A.R.M.	9W-3481	9W-3486		9W-3487	9W-3482	1J-5607 (10)	2J-3507 (10)	
				Straight End	4T-8091		1U-0607 (2)		4T-8091	1J-5607 (10)	2J-3507 (10)	
				Angled End	1U-1896		1U-0607 (2)		1U-1896	1J-5607 (10)	2J-3507 (10)	
928	93.6	2377	CGS	A.R.M.	9W-3481	9W-3483		9W-3483	9W-3482	1J-5607 (10)	2J-3507 (10)	
				Straight End	4T-8091		1U-0295 (2)		4T-8091	1J-5607 (10)	2J-3507 (10)	
				Angled End	1U-1896		1U-0295 (2)		1U-1896	1J-5607 (10)	2J-3507 (10)	
928F, 928G, 924G	99.7	2532	CGS	A.R.M.	9W-3481	9W-3486		9W-3487	9W-3482	1J-5607 (10)	2J-3507 (10)	
				Straight End	4T-8091		8E-4567 (2)		4T-8091	1J-5607 (10)	2J-3507 (10)	
				Angled End	1U-1896		8E-4567 (2)		1U-1896	1J-5607 (10)	2J-3507 (10)	
931, 933, 935	77.5	1969	CGS	A.R.M.	9W-3481	135-6728		135-6729	9W-3482	1J-5607 (10)	2J-3507 (10)	
				Straight End	9W-9944		9W-9943		9W-9944	4F-7827 (8)	2J-3506 (8)	
				Straight End	4T-2914		4T-2915		4T-2914	4F-7827 (7)	2J-3506 (7)	
931, 933, 935 LGP	92.4	2347	CGS	Straight End	4T-2910		4T-2911		4T-2910	4F-7827 (8)	2J-3506 (8)	
				Straight End	4T-8091		1U-0292 (2)		4T-8091	1J-5607 (10)	2J-3507 (10)	
				Angled End	1U-1896		1U-0292 (2)		1U-1896	1J-5607 (10)	2J-3507 (10)	
936, 936E, 936F	72.2	1834	CGS	A.R.M.	9W-3481	9W-3484		9W-3485	9W-3482	1J-5607 (10)	2J-3507 (10)	
				Straight End	4T-8091		107-3746 (2)		4T-8091	1J-5607 (10)	2J-3507 (10)	
				Angled End	1U-1896		107-3746 (2)		1U-1896	1J-5607 (10)	2J-3507 (10)	
938F, 938G	105.9	2690	CGS	A.R.M.	9W-3481	107-3298		107-3299	9W-3482	1J-5607 (10)	2J-3507 (10)	
				Straight End	4T-8091		110-4711 (2)		4T-8091	1J-5607 (10)	2J-3507 (10)	
				Angled End	1U-1896		110-4711 (2)		1U-1896	1J-5607 (10)	2J-3507 (10)	
939	85.0	2159	CGS	A.R.M.	9W-3481	123-9195		123-9196	9W-3482	1J-5607 (10)	2J-3507 (10)	
				Straight End	4T-8091		100-6359 (2)		4T-8091	1J-5607 (10)	2J-3507 (10)	
				Angled End	1U-1896		100-6359 (2)		1U-1896	1J-5607 (10)	2J-3507 (10)	
941, 951	79.8	2027	CGS	Straight End	4T-8091		1U-0605 (2)		4T-8091	1J-5607 (10)	2J-3507 (10)	
				Angled End	1U-1896		1U-0605 (2)		1U-1896	1J-5607 (10)	2J-3507 (10)	
941, 951	93.7	2380	CGS	Straight End	4T-8091		1U-0295 (2)		4T-8091	1J-5607 (10)	2J-3507 (10)	
				Angled End	1U-1896		1U-0295 (2)		1U-1896	1J-5607 (10)	2J-3507 (10)	
				A.R.M.	9W-3482	9W-3486		9W-3487	9W-3481	1J-5607 (10)	2J-3507 (10)	
943	82.1	2086	CGS	Straight End	4T-8091		1U-0294 (2)		4T-8091	1J-5607 (10)	2J-3507 (10)	

Number in parentheses () after the part number indicates the quantity required.

Ground Engaging Tools - Loader Edges

MODEL	BUCKET WIDTH (mm)		BUCKET TYPE	EDGE TYPE	BOLT-ON EDGE PART NUMBER				BOLT	NUT	WASHER	
	(in)	(mm)			(left end)	(center)	(right center)	(right end)				
943 (cont.)	82.1	2086	CGS	Angled End	1U-1896		1U-0294 (2)		1U-1896	1J-5607 (10)	2J-3507 (10)	
	87.0	2210	CGS	Straight End	4T-8091		1U-0293 (2)		4T-8091	1J-5607 (10)	2J-3507 (10)	
	88.8	2256	CGS	Angled End	1U-1896		1U-0293 (2)		1U-1896	1J-5607 (10)	2J-3507 (10)	
944, 950				Straight End	4T-8091		4T-9563 (2)		4T-8091	1J-5607 (10)	2J-3507 (10)	
				Angled End	1U-1896		4T-9563 (2)		1U-1896	1J-5607 (10)	2J-3507 (10)	
	95.2	2419	CGS	Straight End	4T-8101		1U-2414 (2)		4T-8101	4F-4042 (12)	2J-3507 (12)	
				Angled End	1U-1898		1U-2414 (2)		1U-1898	4F-4042 (12)	2J-3507 (12)	
				Heavy Duty	132-1033		132-1030 (2)		132-1033	4F-4042 (12)	2J-3507 (12)	
	103.3	2624	CGS	Straight End	4T-8101		1U-2412 (2)		4T-8101	4F-4042 (12)	2J-3507 (12)	
950				Angled End	1U-1898		1U-2412 (2)		1U-1898	4F-4042 (12)	2J-3507 (12)	
				Heavy Duty	132-1033		132-1031 (2)		132-1033	4F-4042 (12)	2J-3507 (12)	
				A.R.M.	9W-3488	9W-3490			9W-3491	4F-4042 (12)	2J-3507 (12)	
	104.3	2648	CGS	Straight End	4T-8101		1U-2413 (2)		4T-8101	4F-4042 (12)	2J-3507 (12)	
				Angled End	1U-1898		1U-2413 (2)		1U-1898	4F-4042 (12)	2J-3507 (12)	
				Heavy Duty	132-1033		132-1032 (2)		132-1033	4F-4042 (12)	2J-3507 (12)	
950, 960 BEF 950B, 950E, 950F	111.0	2819	Spade	Standard	7T-5964	7T-5961	7T-5962	7T-5963	7T-5960	8T-9079 (18)	3K-9770 (18)	4K-0684 (18)
			CGS	Angled End	1U-1898		1U-0601 (2)		4T-8101	4F-4042 (12)	2J-3507 (12)	
				Straight End	4T8101		1U-0601 (2)		1U-1898	4F-4042 (12)	2J-3507 (12)	
				Heavy Duty	132-1033		132-1034 (2)		132-1033	4F-4042 (12)	2J-3507 (12)	
				A.R.M.	9W-3488	9W-3493		9W-3492	9W-3489	4F-4042 (12)	2J-3507 (12)	
	115.5	2934	CGS	Straight End	4T-8101		139-9230 (2)		4T-8101	4F-4042 (12)	2J-3507 (12)	
950G, 962G				Angled End	1U-1898		139-9230 (2)		1U-1898	4F-4042 (12)	2J-3507 (12)	
				Heavy Duty	132-1033		135-9666 (2)		1321033	4F-4042 (12)	2J-3507 (12)	
	117	2973	Spade	Standard	109-9016	7T-5961	132-1089	7T-5963	109-9017	8T-9079 (18)	3K-9770 (18)	
			CGS	Straight End	4T-8091		1U-0293 (2)		4T-8091	1J-5607 (10)	2J-3507 (10)	
	87.0	2210	CGS	Angled End	1U-1896		1U-0293 (2)		1U-1896	1J-5607 (10)	2J-3507 (10)	
	93.6	2377	CGS	Straight End	4T-8091		1U-0295 (2)		4T-8091	1J-5607 (10)	2J-3507 (10)	
955				Angled End	1U-1896		1U-0295 (2)		1U-1896	1J-5607 (10)	2J-3507 (10)	
				A.R.M.	9W-3482	9W-3486		9W-3487	9W-3481	1J-5607 (10)	2J-3507 (10)	
	88.4	2245	CGS	Straight End	4T-8101		1U-2410 (2)		4T-8101	4F-4042 (12)	2J-3507 (12)	
				Angled End	1U-1898		1U-2410 (2)		1U-1898	4F-4042 (12)	2J-3507 (12)	
	96.0	2438	CGS	Straight End	4T-8101		1U-2411 (2)		4T-8101	4F-4042 (12)	2J-3507 (12)	
	96.0	2438	CGS	Angled End	1U-1898		1U-2411 (2)		1U-1898	4F-4042 (12)	2J-3507 (12)	
960F	119.3	3032	CGS	Straight End	3G-6395		1U-0593 (2)		3G-6395	5P-8823 (12)	3K-9770 (12)	
				Angled End	1U-1897		1U-0593 (2)		1U-1897	5P-8823 (12)	3K-9770 (12)	
				Heavy Duty	100-4044		100-4046 (2)		100-4044	5P-8823 (12)	3K-9770 (12)	

Number in parentheses () after the part number indicates the quantity required.

Ground Engaging Tools - Loader Edges

MODEL	BUCKET WIDTH (mm)		BUCKET TYPE	EDGE TYPE	BOLT-ON EDGE PART NUMBER				BOLT	NUT	WASHER	
	(in)	(mm)			(left end)	(left center)	(center)	(right center)				(right end)
960F (cont.)	119.3	3032	CGS	A.R.M.	123-0336	9W-3478		9W-3477	123-0337	5P-8823 (12)	3K-9770 (12)	
	108.0	2743	CGS	Straight End	4T-8101		1U-0601 (2)		4T-8101	4F-4042 (12)	2J-3507 (12)	
				Angled End	1U-1898		1U-0601 (2)		1U-1898	4F-4042 (12)	2J-3507 (12)	
				Heavy Duty	132-1033		132-1034 (2)		132-1033	4F-4042 (12)	2J-3507 (12)	
963	89.6	2276	CGS	A.R.M.	9W-3488	9W-3493		9W-3492	9W-3489	4F-4042 (12)	2J-3507 (12)	
				Angled End	1U-1898		1U-0599 (2)		1U-1898	4F-4042 (12)	2J-3507 (12)	
				Straight End	4T-8101		1U-0599 (2)		4T-8101	4F-4042 (12)	2J-3507 (12)	
	97.4	2474	CGS	Straight End	4T-8101		1U-0600 (2)		4T-8101	4F-4042 (12)	2J-3507 (12)	
966C	98.7	2507	CGS	Angled End	1U-1897		8E-5793 (2)		1U-1897	6V-6535 (12)	3K-9770 (12)	
				Straight End	3G-6395		8E-5793 (2)		3G-6395	6V-6535 (12)	3K-9770 (12)	
	112.0	2845	CGS	Straight End	3G-6395		1U-2406 (2)		3G-6395	5P-8823 (12)	3K-9770 (12)	
				Angled End	1U-1897		1U-2406 (2)		1U-1897	5P-8823 (12)	3K-9770 (12)	
966D	115.0	2920	CGS	Heavy Duty	100-4044		100-4045 (2)		100-4044	5P-8823 (12)	3K-9770 (12)	
				A.R.M.	123-0336	107-3282		107-3283	123-0337	5P-8823 (12)	3K-9770 (12)	
	112.1	2848	CGS	Straight End	3G-6395		1U-2407 (2)		3G-6395	5P-8823 (12)	3K-9770 (12)	
				Angled End	1U-1897		1U-2407 (2)		1U-1897	5P-8823 (12)	3K-9770 (12)	
966E, 966F	115.0	2920	CGS	Straight End	3G-6395		1U-1909 (2)		3G-6395	5P-8823 (12)	3K-9770 (12)	
				Angled End	1U-1897		1U-1909 (2)		1U-1897	5P-8823 (12)	3K-9770 (12)	
				Heavy Duty	100-4044		135-9533 (2)		100-4044	5P-8823 (12)	3K-9770 (12)	
	119.4	3032	CGS	A.R.M.	123-0336	107-3282		107-3283	123-0337	5P-8823 (12)	3K-9770 (12)	
966G, 972G	121.5	3086	Spade	Standard	4T-9127	4T-9125	4T-9185	4T-9126	4T-9128	6V-6535 (16)	3K-9770 (16)	
	124	3150	CGS	Straight End	3G-6395		1U-0593 (2)		3G-6395	5P-8823 (12)	3K-9770 (12)	
				Angled End	1U-1897		1U-0593 (2)		1U-1897	5P-8823 (12)	3K-9770 (12)	
				Heavy Duty	100-4044		100-4046 (2)		100-4044	5P-8823 (12)	3K-9770 (12)	
970F	130.4	3311	CGS	A.R.M.	123-0336	9W-3478		9W-3477	123-0337	5P-8823 (12)	3K-9770 (12)	
				Straight End	3G-6395		100-6668 (2)		3G-6395	5P-8823 (12)	3K-9770 (12)	
				Angled End	1U-1897		100-6668 (2)		1U-1897	5P-8823 (12)	3K-9770 (12)	
				Heavy Duty	167-7430		140-6823 (2)		167-7430	5P-8823 (12)	3K-9770 (12)	
970F	130	3306	Spade	A.R.M.	123-0336	107-3286		107-3287	123-0336	5P-8823 (12)	3K-9770 (12)	
	115.5	2934	CGS	Standard	135-8242	135-8244	135-8240	135-8243	135-8241	6V-6535 (18)	3K-9770 (18)	
				Straight End	3G-6395		1U-1909 (2)		3G-6395	5P-8823 (12)	3K-9770 (12)	
				Heavy Duty	167-7430		140-6823 (2)		167-7430	5P-8823 (12)	3K-9770 (12)	

Number in parentheses () after the part number indicates the quantity required.

Ground Engaging Tools - Loader Edges

MODEL	BUCKET WIDTH (mm)		BUCKET TYPE	EDGE TYPE	BOLT-ON EDGE PART NUMBER				BOLT	NUT	WASHER		
	(in)	(mm)			(left end)	(left center)	(center)	(right center)				(right end)	
970F (cont.)	115.5	2934	CGS	Angled End	1U-1897				1U-1897	5P-8823 (12)	3K-9770 (12)		
				Heavy Duty	100-4044				100-4044	5P-8823 (12)	3K-9770 (12)		
	A.R.M.	123-0336		107-3282		107-3283		123-0337	5P-8823 (12)	3K-9770 (12)			
	Straight End	3G-6395					3G-6395	5P-8823 (12)	3K-9770 (12)				
	119.7	3040	CGS	Angled End	1U-1897				1U-1897	5P-8823 (12)	3K-9770 (12)		
				Heavy Duty	100-4044				100-4044	5P-8823 (12)	3K-9770 (12)		
				A.R.M.	123-0336	9W-3478		9W-3477		123-0337	5P-8823 (12)	3K-9770 (12)	
				Straight End	3G-6395				3G-6395	5P-8823 (12)	3K-9770 (12)		
973	126.0	3200	CGS	Angled End	1U-1897				1U-1897	5P-8823 (12)	3K-9770 (12)		
				Heavy Duty	100-4044				100-4044	5P-8823 (12)	3K-9770 (12)		
				A.R.M.	123-0336	107-3286		107-3287		123-0337	5P-8823 (12)	3K-9770 (12)	
				Straight End	3G-6395				3G-6395	5P-8823 (12)	3K-9770 (12)		
	102.8	2610	CGS	Angled End	1U-1897				1U-1897	5P-8823 (12)	3K-9770 (12)		
				Standard	9W-3677				9W-3678	6V-6535 (12)	3K-9770 (12)		
				Straight End	3G-6395				3G-6395	5P-8823 (12)	3K-9770 (12)		
				Angled End	1U-1897				1U-1897	5P-8823 (12)	3K-9770 (12)		
	106.5	2705	CGS	Angled End	1U-1897				1U-1897	5P-8823 (12)	3K-9770 (12)		
				Standard	9W-3677				9W-3678	6V-6535 (12)	3K-9770 (12)		
				Straight End	3G-6395				3G-6395	5P-8823 (12)	3K-9770 (12)		
				Angled End	1U-1897				1U-1897	5P-8823 (12)	3K-9770 (12)		
	112.1	2847	CGS	Angled End	1U-1897				1U-1897	5P-8823 (12)	3K-9770 (12)		
				Straight End	3G-6395				3G-6395	5P-8823 (12)	3K-9770 (12)		
				Angled End	1U-1897				1U-1897	5P-8823 (12)	3K-9770 (12)		
				Straight End	3G-6395				3G-6395	5P-8823 (12)	3K-9770 (12)		
	96.0	2438	CGS	Angled End	1U-1897				1U-1897	5P-8823 (12)	3K-9770 (12)		
				Straight End	3G-6395				3G-6395	5P-8823 (12)	3K-9770 (12)		
				Angled End	1U-1897				1U-1897	5P-8823 (12)	3K-9770 (12)		
				Straight End	3G-6395				3G-6395	5P-8823 (12)	3K-9770 (12)		
	112.8	2864	CGS	Angled End	1U-1897				1U-1897	5P-8823 (12)	3K-9770 (12)		
				Straight End	3G-6395				3G-6395	5P-8823 (12)	3K-9770 (12)		
				Angled End	1U-1897				1U-1897	5P-8823 (12)	3K-9770 (12)		
				Straight End	3G-6395				3G-6395	5P-8823 (12)	3K-9770 (12)		
	128.8	3270	CGS	Angled End	1U-1897				1U-1897	5P-8823 (12)	3K-9770 (12)		
				Straight End	3G-6395				3G-6395	5P-8823 (12)	3K-9770 (12)		
				Angled End	1U-1897				1U-1897	5P-8823 (12)	3K-9770 (12)		
				Straight End	3G-6395				3G-6395	5P-8823 (12)	3K-9770 (12)		
	130.8	3323	CGS	Angled End	1U-1897				1U-1897	5P-8823 (12)	3K-9770 (12)		
				Straight End	3G-6395				3G-6395	5P-8823 (12)	3K-9770 (12)		
				Angled End	1U-1897				1U-1897	5P-8823 (12)	3K-9770 (12)		
				Straight End	3G-6395				3G-6395	5P-8823 (12)	3K-9770 (12)		
	132.5	3366	CGS	Angled End	1U-1897				1U-1897	5P-8823 (12)	3K-9770 (12)		
				Straight End	3G-6395				3G-6395	5P-8823 (12)	3K-9770 (12)		
				Angled End	1U-1897				1U-1897	5P-8823 (12)	3K-9770 (12)		
				Straight End	3G-6395				3G-6395	5P-8823 (12)	3K-9770 (12)		
	134.0	3404	CGS	Angled End	1U-1897				1U-1897	5P-8823 (12)	3K-9770 (12)		
				Straight End	3G-6395				3G-6395	5P-8823 (12)	3K-9770 (12)		
				Angled End	1U-1897				1U-1897	5P-8823 (12)	3K-9770 (12)		
				Straight End	3G-6395				3G-6395	5P-8823 (12)	3K-9770 (12)		
	137.5	3493	Spade	Angled End	1U-1897				1U-1897	5P-8823 (12)	3K-9770 (12)		
				Straight End	3G-6395				3G-6395	5P-8823 (12)	3K-9770 (12)		
				Angled End	1U-1897				1U-1897	5P-8823 (12)	3K-9770 (12)		
				Straight End	3G-6395				3G-6395	5P-8823 (12)	3K-9770 (12)		

Number in parentheses () after the part number indicates the quantity required.

Ground Engaging Tools - Loader Edges

MODEL	BUCKET WIDTH (mm)		BUCKET TYPE	EDGE TYPE	BOLT-ON EDGE PART NUMBER				BOLT	NUT	WASHER		
	(in)	(mm)			(left end)	(left center)	(center)	(right center)				(right end)	
988B	140.2	3561	CGS	Straight End	1U-0761		9W-1375 (2)		1U-0761	5P-8823 (12)	3K-9770 (12)		
				Angled End	1U-0764		9W-1375 (2)		1U-0764	5P-8823 (12)	3K-9770 (12)		
	143.5	3645	Straight	A.R.M.	123-0334	109-2697		109-2697	123-0335	5P-8823 (12)	3K-9770 (12)		
				Standard			4T-6588 (3)				4J-9058 (18)	2J-3507 (18)	
	143.5	3645	Spade	Standard	9W-5732		9W-5733	9W-5736	9W-5735	6V-6535 (25)	3K-9770 (25)		
				Heavy Duty	106-1097	106-1098	106-1096	106-1094	106-1095	5P-8823 (25)	3K-9770 (25)	4K-0684 (25)	
143.5	3645	Straight	Standard	9W-8249		9W-8250		9W-8249	6V-6535 (11)	3K-9770 (11)			
988F	145.5	3696	CGS	Straight End	1U-0761		104-5841 (2)		1U-0761	5P-8823 (12)	3K-9770 (12)		
				Angled End	1U-0764		104-5841 (2)		1U-0764	5P-8823 (12)	3K-9770 (12)		
				Heavy Duty			183-5325 (2)						
				A.R.M.	123-0334	132-1070		132-1069	123-0335	5P-8823 (12)	3K-9770 (12)		
	148.5	3772	Spade	Standard	101-9352		101-9350		101-9351	6V-6535 (21)	3K-9770 (21)		
				Heavy Duty	107-3544		107-3540		107-3543	6V-6535 (21)	3K-9770 (21)		
148.5	3772	Straight	A.R.M.	136-6794		136-6770		136-6773	6V-6535 (21)	3K-9770 (21)			
			Standard	102-2184		101-9350		102-2184	6V-6535 (21)	3K-9770 (21)			
175.5	4458	Spade	Heavy Duty	107-3541		107-3540		107-3541	6V-6535 (21)	3K-9770 (21)			
			A.R.M.	132-1067		132-1068		132-1067	6V-6535 (21)	3K-9770 (21)			
990	175.2	4450	Straight	Standard	162-3296	106-6423	106-6420	106-6421	162-3297	6V-6535 (28)	3K-9770 (28)		
				Standard	106-6378		106-6377 (2)		106-6378	6V-6535 (26)	3K-9770 (26)		
992C, 992D, 992G	187.0	4750	Spade	Standard	6I-8368	6I-8367	6I-8364	6I-8365	6I-8366	5P-8823 (28)	3K-9770 (28)		
				Heavy Duty	127-7430	127-7432	127-7429	127-7433	127-7431	5P-8823 (28)	3K-9770 (28)		
IT12	85.1	2162	CGS	Straight End	4T-2914		4T-2913		4T-2914	4F-7827 (7)	2J-3506 (7)		
IT14G	93.1	2365	CGS	Straight End	4T-2914		9W-8620		4T-2914	4F-7827 (8)	2J-3506 (8)		
IT18, IT28	93.6	2377	CGS	Straight End	4T-8091		1U-0295 (2)		4T-8091	1J-5607 (10)	2J-3507 (10)		
				Angled End	1U-1896		1U-0295 (2)		1U-1896	1J-5607 (10)	2J-3507 (10)		
IT24F, IT28F	99.5	2527	CGS	A.R.M.	9W-3481	9W-3486		9W-3487	9W-3482	1J-5607 (10)	2J-3507 (10)		
				Straight End	4T-8091		8E-4567 (2)		4T-8091	1J-5607 (10)	2J-3507 (10)		
IT38G	104.2	2647	CGS	Angled End	1U-1896		8E-4567 (2)		1U-1896	1J-5607 (10)	2J-3507 (10)		
				Straight End	4T-8091		1U-0292 (2)		4T-8091	1J-5607 (12)	2J-3507 (10)		
				Angled End	1U-1896		1U-0292 (2)		1U-1896	1J-5607 (10)	2J-3507 (10)		
				A.R.M.	9W-3481	9W-3484		9W-3485	9W-3482	1J-5607 (10)	2J-3507 (10)		

Number in parentheses () after the part number indicates the quantity required.

Ground Engaging Tools - Loaders Segments

Bolt-On Segments

Bolt-on segments bolt directly to the bottom of the base edge between adapters. Bolt-on segments:

- Increase bucket capacity.
- Maintain a smoother work surface.
- Protect the base edge between teeth, eliminating scalloping.
- Increase base edge life up to five times.
- Hardened to 430-520 Brinell.

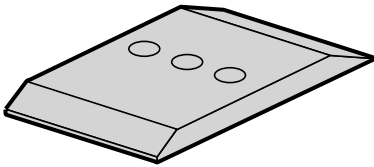

Standard Bolt-On Segments

- Reversible for a second wear life.

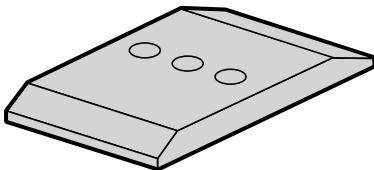

Heavy Duty Bolt-On Segments

- Provide at least 50% more wear material than standard bolt-on segments.
- Reversible for a second wear life.

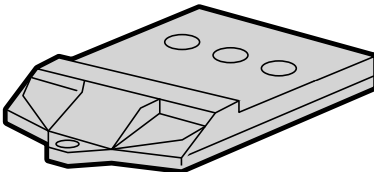

Half-Arrow Bolt-On Segments

- Stay sharper and enhance protection of the base edge front and bevel.
- Protect against scalloping of the base edge between adapters.
- Protect against scalloping of the segment.
- Match bottom strap thickness of the shouldered adapters.

Ground Engaging Tools - Loader Segments

MODEL	BUCKET WIDTH (mm)		BUCKET TYPE	SEGMENT TYPE	BOLT-ON SEGMENT PART NUMBER			BOLT	NUT
	(in)	(mm)			(lh)	(ctr)	(rh)		
910, 914G	85.1	2162	CGS	Standard		128-2873 (6)		4F-7827 (12)	2J-3506 (12)
	89.5	2273	CGS	Standard	128-2872 (2)		128-2872 (2)	4F-7827 (12)	2J-3506 (12)
	94.0	2388	CGS	Standard			128-2873 (7)	4F-7827 (14)	2J-3506 (14)
916, 924F, 926	93.6	2378	CGS	Standard			4T-6694 (7)	1J-5607 (14)	2J-3507 (14)
				Heavy-Duty			132-1035 (7)	1J-5607 (14)	2J-3507 (14)
920, 930	95.3	2421	CGS	Standard	4T-6693		4T-6693 (5)	1J-5607 (14)	2J-3507 (14)
	93.6	2377	CGS	Standard			4T-6694 (7)	1J-5607 (14)	2J-3507 (14)
928F, 928G, 924G	99.7	2532	CGS	Standard			132-1035 (7)	1J-5607 (14)	2J-3507 (14)
	93.1, 933, 935	1969	CGS	Standard			8E-4569 (7)	1J-5607 (14)	2J-3507 (14)
936, 936E, 936F, 938F, 938G	104.2	2647	CGS	Standard			6Y-6362 (7)	4F-7827 (14)	2J-3506 (14)
				Standard			4T-6695 (7)	1J-5607 (14)	2J-3507 (14)
939	85.0	2159	CGS	Heavy-Duty			132-1037 (7)	1J-5607 (14)	2J-3507 (14)
	79.8	2027	CGS	Standard			4T-6692 (7)	1J-5607 (14)	2J-3507 (14)
941, 951	93.7	2380	CGS	Standard			4T-6691 (7)	1J-5607 (14)	2J-3507 (14)
				Standard			4T-6694 (7)	1J-5607 (14)	2J-3507 (14)
943	82.1	2086	CGS	Standard			132-1035 (7)	1J-5607 (14)	2J-3507 (14)
	87.0	2210	CGS	Standard			4T-6692 (7)	1J-5607 (14)	2J-3507 (14)
944, 950	88.8	2256	CGS	Standard	4T-6693		4T-6692 (5)	1J-5607 (14)	2J-3507 (14)
	95.2	2419	CGS	Standard	4T-6693		4T-6694 (5)	1J-5607 (14)	2J-3507 (14)
950, 960 BEF	111.0	2819	Spade	Heavy-Duty	132-1036		132-1035 (5)	1J-5607 (14)	2J-3507 (14)
				Standard	4T-9124 (3)		4T-3015	8T-9079 (21)	3K-9770 (21)
950B, 950E, 950F	180.0	2744	CGS	Heavy Duty	140-6864 (3)		140-6862	8T-9079 (21)	3K-9770 (21)
				Standard			4T-6695 (7)	4F-4042 (14)	2J-3507 (14)
950G, 962G	115.5	2934	CGS	Heavy-Duty			132-1037 (7)	4F-4042 (14)	2J-3507 (14)
	87.0	2210	CGS	Standard			132-4715 (7)	4F-4042 (14)	2J-3507 (14)
953	93.6	2377	CGS	Standard			4T-6692 (7)	1J-5607 (14)	2J-3507 (14)
	88.4	2245	CGS	Standard			4T-6694 (7)	1J-5607 (14)	2J-3507 (14)
960F	108.0	2743	CGS	Standard			4T-6692 (7)	4F-4042 (14)	2J-3507 (14)
				Standard			4T-6695 (7)	4F-4042 (14)	2J-3507 (14)
963	119.4	3032	CGS	Heavy-Duty			132-1037 (7)	4F-4042 (14)	2J-3507 (14)
				Standard			4T-6699 (7)	5P-8823 (14)	3K-9770 (14)
963	97.4	2474	CGS	Heavy Duty			140-6868 (7)	5P-8823 (14)	3K-9770 (14)
				Half Arrow			174-4114 (7)	5P-8823 (14)	3K-9770 (14)
963	89.6	2276	CGS	Standard			4T-6694 (7)	4F-4042 (14)	2J-3507 (14)
				Heavy-Duty			132-1035 (7)	4F-4042 (14)	2J-3507 (14)
			CGS	Standard	4T-6693		4T-6692 (5)	4F-4042 (14)	2J-3507 (14)

Number in parentheses () after the part number indicates the quantity required.

Ground Engaging Tools - Loader Segments

MODEL	BUCKET WIDTH (mm)		BUCKET TYPE	SEGMENT TYPE	BOLT-ON SEGMENT PART NUMBER			BOLT	NUT
	(in)	(mm)			(lh)	(ctr)	(rh)		
963B	98.7	2507	CGS	Standard	4T-6697	4T-6696 (5)	4T-6697	5P-8823 (14)	3K-9770 (14)
	98.7	2507	CGS	Heavy Duty	140-6866	140-6865 (5)	140-6866	5P-8823 (14)	3K-9770 (14)
966C	112.0	2845	CGS	Standard		4T-6698 (7)		5P-8823 (14)	3K-9770 (14)
	119.4	3032	CGS	Heavy Duty		140-6867 (7)		5P-8823 (14)	3K-9770 (14)
966D, 966E, 966F	119.4	3032	CGS	Standard		4T-6699 (7)		5P-8823 (14)	3K-9770 (14)
				Heavy Duty		140-6868 (7)		5P-8823 (14)	3K-9770 (14)
966F	121.5	3086	Spade	Half Arrow		174-4114 (7)		5P-8823 (14)	3K-9770 (14)
				Standard	4T-9124 (3)	4T-6697	4T-9123 (3)	6V-6535 (14)	3K-9770 (14)
966G, 972G	124	3150	CGS	A.R.M.	135-9649 (3)	135-9648	135-9647 (3)	6V-6535 (14)	3K-9770 (14)
				Standard		4T-6697 (7)		5P-8823 (14)	3K-9770 (14)
970F	130	3306	Spade	Heavy Duty		140-6868 (7)		5P-8823 (14)	3K-9770 (14)
				Heavy Duty	135-9296 (3)	135-9294	135-9295 (3)	6V-6535 (14)	3K-9770 (14)
973	130.4	3311	CGS	Half Arrow		135-9546 (3)		6V-6535 (14)	3K-9770 (14)
				Standard	100-6666 (7)	100-6666 (7)		5P-8823 (14)	3K-9770 (14)
977	115.5	2934	CGS	Heavy Duty		140-6870 (7)		5P-8823 (14)	3K-9770 (14)
				Standard	100-6664 (7)	100-6664 (7)		5P-8823 (14)	3K-9770 (14)
980A, 980B	119.4	3032	CGS	Heavy Duty		140-6869 (7)		5P-8823 (14)	3K-9770 (14)
				Standard	4T-6699 (7)	4T-6699 (7)		5P-8823 (14)	3K-9770 (14)
980F	126.0	3200	CGS	Heavy Duty		140-6868 (7)		5P-8823 (14)	3K-9770 (14)
				Half Arrow	174-4114 (7)	174-4114 (7)		5P-8823 (14)	3K-9770 (14)
973	106.5	2705	Spade	Standard	4T-9124 (2)	4T-3015 (2)	4T-9123 (2)	6V-6535 (12)	3K-9770 (12)
	112.1	2847	CGS	Standard		4T-6698 (7)		5P-8823 (14)	3K-9770 (14)
977	102.8	2610	CGS	Heavy Duty		140-6869 (7)		5P-8823 (14)	3K-9770 (14)
				Standard	4T-6697 (7)	4T-6697 (7)		5P-8823 (14)	3K-9770 (14)
980A, 980B	96.0	2438	CGS	Heavy Duty		140-6866 (7)		5P-8823 (14)	3K-9770 (14)
				A.R.M.	135-9648 (7)	135-9648 (7)		5P-8823 (14)	3K-9770 (14)
980F	128.8	3270	CGS	Standard	4T-6700 (7)	4T-6700 (7)		5P-8823 (14)	3K-9770 (14)
				Heavy Duty	107-8580 (7)	107-8580 (7)		5P-8823 (14)	3K-9770 (14)
980F	132.7	3371	Spade	Half Arrow		173-7447 (7)		5P-8823 (14)	3K-9770 (14)
				Standard	4T-7140 (3)	4T-3015	4T-7139 (3)	6V-6535 (14)	3K-9770 (14)
980F				Heavy-Duty	107-8584 (3)	107-8582	107-8583 (3)	6V-6535 (14)	3K-9770 (14)
				Half Arrow	113-3142 (3)	113-3140	113-3141 (3)	8T-9079 (14)	3K-9770 (14)

Number in parentheses () after the part number indicates the quantity required.

Ground Engaging Tools - Loader Segments

MODEL	BUCKET WIDTH (mm)		BUCKET TYPE	SEGMENT TYPE	BOLT-ON SEGMENT PART NUMBER			BOLT	NUT
	(in)	(mm)			(lh)	(ctr)	(rh)		
980F (cont.)	130.8	3323	CGS	Standard		4T-6700		5P-8823 (14)	3K-9770 (14)
				Heavy-Duty		107-8580 (7)		5P-8823 (14)	3K-9770 (14)
980G	134.0	3404	CGS	Half Arrow		137-7447 (7)		5P-8823 (14)	3K-9770 (14)
				Standard		109-9019 (7)		5P-8823 (14)	3K-9770 (14)
			Heavy Duty		135-8219 (7)		5P-8823 (14)	3K-9770 (14)	
			Half Arrow		174-4115 (7)		5P-8823 (14)	3K-9770 (14)	
988B	137.5	3493	Spade	Standard	9W-5730 (3)	9W-5734	9W-5737 (3)	8T-9079 (21)	3K-9770 (21)
				Heavy-Duty	107-3492 (3)	107-3490	107-3491 (3)	8T-9079 (21)	3K-9770 (21)
	140.2	3561	CGS	Half Arrow	116-7462 (3)	116-7460	116-7461 (3)	8T-9079 (21)	3K-9770 (21)
				Standard	4T-6700 (7)			5P-8823 (14)	3K-9770 (14)
			Heavy Duty		107-8580 (7)			5P-8823 (14)	3K-9770 (14)
			Half Arrow		173-7447 (7)			5P-8823 (14)	3K-9770 (14)
988F, 988G	143.5	3645	Spade	Standard	9W-5730 (3)	9W-5734	9W-5737 (3)	6V-6535 (21)	3K-9770 (21)
				Heavy-Duty	107-3492 (3)	107-3490	107-3491 (3)	6V-6535 (21)	3K-9770 (21)
	143.5	3645	Straight	Half Arrow	116-7462 (3)	116-7460	116-7461 (3)	6V-6535 (21)	3K-9770 (21)
				Standard	9W-5734 (7)			6V-6535 (21)	3K-9770 (21)
			Heavy-Duty		107-3490 (7)			6V-6535 (21)	3K-9770 (21)
			Half Arrow		116-7460 (7)			6V-6535 (21)	3K-9770 (21)
990	148.5	3772	CGS	Standard	138-6540 (7)			6V-6535 (14)	3K-9770 (14)
				Standard	101-9437 (3)	101-9435	101-9436 (3)	6V-6535 (21)	3K-9770 (21)
	148.5	3772	Spade	Heavy-Duty	107-3538 (3)	107-3536	107-3537 (3)	6V-6535 (21)	3K-9770 (21)
				Half Arrow	109-9082 (3)	109-9080	109-9081 (3)	6V-6535 (21)	3K-9770 (21)
	148.5	3772	Straight	Standard	101-9435 (7)			6V-6535 (21)	3K-9770 (21)
				Heavy-Duty	107-3536 (7)			6V-6535 (21)	3K-9770 (21)
		Half Arrow		109-9080 (7)			6V-6535 (21)	3K-9770 (21)	
992C, 992D,	175.5	4458	Spade	Light Duty	4T-6762 (3)	4T-6760	4T-6761 (3)	5P-8823 (28)	3K-9770 (28)
				Light Duty	4T-6760 (7)			5P-8823 (28)	3K-9770 (28)
	187	4750	Spade	Standard	107-3532 (3)	107-3530	107-3531 (3)	5P-8823 (28)	3K-9770 (28)
				Heavy Duty	107-6296 (3)	107-6294	107-6295 (3)	5P-8823 (28)	3K-9770 (28)
992G	189.9	4823	Spade	Half Arrow	119-9602 (3)	119-9600	119-9601 (3)	5P-8823 (28)	3K-9770 (28)
				HD Half Arrow	109-2677 (3)	109-2675	109-2676 (3)	5P-8823 (28)	3K-9770 (28)
	187	4750	Straight	Standard	107-3530 (7)			5P-8823 (28)	3K-9770 (28)
				Heavy Duty	107-6294 (7)			5P-8823 (28)	3K-9770 (28)
994	222.0	5640	Spade	Half Arrow	119-9600 (7)			5P-8823 (28)	3K-9770 (28)
				HD Half Arrow	109-2675 (7)			5P-8823 (28)	3K-9770 (28)
	222.0	5640	Spade	Standard	103-1835 (2)	103-1833 (3)	103-1834 (2)	5P-8823 (35)	3K-9770 (35)
				Half Arrow	109-9032 (2)	109-9030 (3)	109-9031 (2)		

Number in parentheses () after the part number indicates the quantity required.

Ground Engaging Tools - Loader Segments

MODEL	BUCKET WIDTH (mm)		BUCKET TYPE	SEGMENT TYPE	BOLT-ON SEGMENT PART NUMBER			BOLT	NUT
	(in)	(mm)			(lh)	(ctr)	(rh)		
994 (cont.)	222.0	5640	Spade	Standard	103-1835 (3)	107-3383	103-1834 (3)	5P-8823 (35)	3K-9770 (35)
				Half Arrow	109-9032 (3)	109-9033	109-9031 (3)		
	245.0	6220	Spade	Standard	8E-3159 (3)	8E-3157 (2)	8E-3158 (3)	6V-8360 (40)	3K-9770 (40)
				Half Arrow	103-1835 (3)	103-1833 (2)	103-1834 (3)	5P-8823 (40)	3K-9770 (40)
IT12	222.0	5640	Straight	Standard	109-9032 (3)	109-9030 (2)	109-9031 (3)	5P-8823 (40)	3K-9770 (40)
				Standard	8E-3157 (7)	8E-3157 (7)		6V-6535 (35)	3K-9770 (35)
	93.6	2377	CGS	Standard	128-2873 (6)	128-2873 (6)		4F-7827 (12)	2J-3506 (12)
				Heavy-Duty	4T-6694 (7)	4T-6694 (7)		1J-5607 (14)	2J-3507 (14)
IT24F, IT28F	99.5	2527	CGS	Standard	132-1035 (7)	132-1035 (7)		1J-5607 (14)	2J-3507 (14)
				Heavy-Duty	8E-4569 (7)	8E-4569 (7)		1J-5607 (14)	2J-3507 (14)
IT38G	104.2	2647	CGS	Standard	4T-6695 (7)	4T-6695 (7)		1J-5607 (14)	2J-3507 (14)
				Heavy Duty	132-1037 (7)	132-1037 (7)		1J-5607 (14)	2J-3507 (14)

Number in parentheses () after the part number indicates the quantity required.

Ground Engaging Tools - Loader Wear Plates

Wear Plates

Wear plates offer enhanced protection to the base edge, bucket sides, and bucket rear.

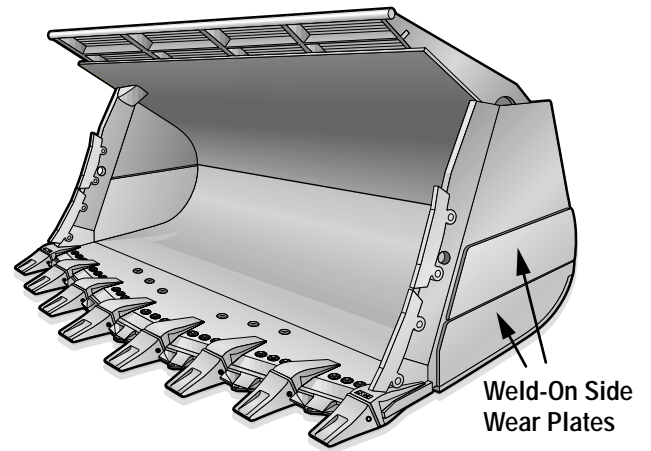
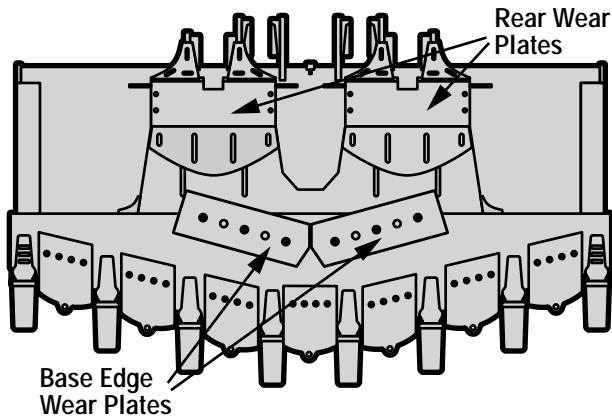

Base Edge Wear Plates

- Cover the bottom area of the base edge not protected by segments.
- Extend base edge life.

Heavy Duty Base Edge Wear Plates

- Provide extended base edge life due to a thicker base edge wear plate.

Rear Wear Plates

- Extend life by protecting the rear of the bucket.

Ground Engaging Tools - Loader Wear Plates

Wear Plates

Heavy Duty Rear Wear Plates

- Extend life by protecting the rear of the bucket.
- Provide more protection than the standard rear wear plates.

Weld-On Rear Wear Plates

- Extend life by protecting the rear of the bucket.

Weld-On Side Wear Plates

- Protect against bucket side plate wear.

Ground Engaging Tools - Loader Wear Plates

MODEL	BUCKET WIDTH		WEAR PLATE TYPE	WEAR PLATE PART NUMBER			BOLT	NUT	WASHER
	(in)	(mm)		(lh)	(ctr)	(rh)			
938F, 938 G			Weld-On Rear		9V-4484 (4)				
			Rear		9W-6747 (2)		4F-7827 (8)	2J-3506 (8)	5P-8248 (8)
944, 950			Rear		9W-6747 (2)		4F-7827 (8)	2J-3506 (8)	5P-8248 (8)
			Weld-On Rear		9V-6105 (2)				
950B, E, F, G			Rear		9W-6747 (2)		4F-7827 (8)	2J-3506 (8)	5P-8248 (8)
			Weld-On		9V-2899 (4)				
960F, 962G			Rear		9W-6747 (2)		4F-7827 (8)	2J-3506 (8)	5P-8248 (8)
	108	2743	Rear		9W-6747 (2)		4F-7827 (8)	2J-3506 (8)	5P-8248 (8)
963			Rear		9W-6748 (2)		4F-7827 (8)	2J-3506 (8)	5P-8248 (8)
			Weld-On Rear		9V-6106 (2)		5P-8823 (14)	3K9770 (14)	
966D, E, F			Rear		9W-6749 (2)		5J-4773 (8)	2J-3506 (8)	5P-8248 (8)
			Rear		161-8573 (2)		5J-4773 (8)	2J-3506 (8)	5P-8248 (8)
966G, 972G			Rear		9W-6749 (2)		5J-4773 (8)	2J-3506 (8)	5P-8248 (8)
			Rear		9W-6750 (2)		5J-4773 (8)	2J-3506 (8)	5P-8248 (8)
970F			Rear		9W-6106 (2)		5P-8823 (14)	3K9770 (14)	
			Weld-On Rear		9V-6109 (2)		5J-4773 (8)	2J-3506 (8)	5P-8248 (8)
973			Rear		7V-0910 (2)		5J-4773 (8)	2J-3506 (8)	5P-8248 (8)
			Rear		9W-6750 (2)		5J-4773 (8)	2J-3506 (8)	5P-8248 (8)
977			Rear		109-9215 (2)		5J-4773 (8)	2J-3506 (8)	5P-8248 (8)
			Weld-On Rear		9V-6106 (2)		4F-4042 (6)	2J-3507 (6)	5P-8250 (6)
980C			Rear		9V-6109 (2)		4F-4042 (6)	2J-3507 (6)	5P-8250 (6)
			Rear		7V-0910 (2)		4J-9058 (8)	2J-3507 (8)	5P-8250 (8)
980C			Rear		9W-6750 (2)		4J-9058 (8)	2J-3507 (8)	5P-8250 (8)
			Rear		109-9215 (2)		4J-9058 (8)	2J-3507 (8)	5P-8250 (8)
980F, G			Rear		1U-4929		1D-4709 (8)	2J-3507 (8)	5P-8250 (8)
			Base Edge	1U-4929		190-9793			
988B, 988F	143.5	3645	Base Edge**	7T-9127**		190-9794			
	148.5	3772	Rear		9V-5793 (2)				
988G			Heavy Duty Rear		6Y-3609 (2)				
			HEX Bolt Rear		132-4713 (2)				
990			Weld-On Rear	190-9793	136-6205	190-9793			
			Intermediate	190-9794		190-9794			
992C, 992D			Weld-On Rear	136-6204	136-6205	136-6204			
			Intermediate	154-6367		154-6367			
992G			Base Edge	1U-4929		1U-4929			
			Base Edge**	6Y-0312**		6Y-0311**			
992G			Heavy Duty Rear		6Y-3573 (2)				
			Base Edge	1U-4933		1U-4933			
992G			Base Edge**	6Y-0312**		6Y-0311**			
			Rear		6W-0276 (2)				
992G			Heavy Duty Rear		6Y-3610 (2)				
			HEX Bolt Rear		132-4712 (2)				
992G			Base Edge	1U-4933		1U-4933			
	189.9	4823	Base Edge						

Number in parentheses () after the part number indicates the quantity required.

** Use with half arrow segments.

Ground Engaging Tools - Loader Wear Plates

MODEL	BUCKET WIDTH		WEAR PLATE TYPE	WEAR PLATE PART NUMBER			BOLT	NUT	WASHER	
	(in)	(mm)		(lh)	(ctr)	(rh)				
992G (cont.)	189.9	4823	Base Edge**	6Y-0312**		6Y-0311**	4J-9058 (6)	2J-3507 (6)	5P-8250 (6)	
			Weld-On Rear	115-1548	115-1549	115-1548	4J-9058 (6)	2J-3507 (6)	5P-8250 (6)	
	190.6	4841	Base Edge	100-6356	100-6357	100-6356	4J-9058 (12)	2J-3507 (12)	5P-8250 (12)	
			Weld-On Rear	115-1548	115-1549	115-1548				
			Weld-On Side		112-8998					
994	222.0	5640	Base Edge		103-1833 (3)		5P-8823 (9)	3K-9770 (9)		
			Heavy Duty Rear		8E-3160 (2)		6V-8360 (8)	3K-9770 (8)	4K-0684 (8)	
			Rear		100-4015 (2)		6V-8360 (8)	3K-9770 (8)	4K-0684 (8)	
			HEX Bolt Rear		132-4714 (2)		1S-6560 (8)	3K-9770 (8)	4K-0684 (8)	
			Weld-On Rear	2A-6724 (2)		2A-6724 (2)				
	245.0	6220	Base Edge	103-1835	103-1833	103-1834	5P-8823 (1)	3K-9770 (1)		
			Heavy Duty Rear		8E-3160 (2)		6V-8360 (8)	3K-9770 (8)	4K-0684 (8)	
			Rear		100-4015 (2)		6V-8060 (8)	3K-9770 (8)	4K-0684 (8)	
			HEX Bolt Rear		132-4714 (2)		1S-6560 (8)	3K-9770 (8)	4K-0684 (8)	
			Weld-On Rear	2A-6724 (2)		2A-6724 (2)				

Number in parentheses () after the part number indicates the quantity required.

** Use with half arrow segments.

Ground Engaging Tools - Loader Sidebar Protectors

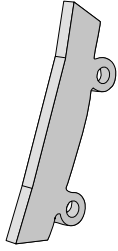

Sidebar Protectors

- Protect the bucket sides.

MODEL	BUCKET TYPE	SIDEBAR PROTECTOR	PIN	RETAINER ASSEMBLY
980F, 980G	Rock	9J-9600 (2)	135-9350 (4)	114-0359 (4)
988B, F, G	Rock	9J-9600 (2)	135-9350 (4)	114-0359 (4)
990, 992C, D, 992G	Rock	1U-0740 (2)	133-0738 (4)	107-8559 (4)
966G	Rock	135-8246 (4)	135-9292 (8)	114-0359 (8)
972G	Rock	135-8246 (4)	135-9292 (8)	114-0359 (8)



Bucket Corner Protector

TIP SIZE	CORNER PROTECTOR PART NUMBER		BOLT	NUT
	LEFT HAND	RIGHT HAND		
J250	173-5423	173-5422	4F-4042 (4)	2J-3507 (4)
J300	173-5425	173-5424	8T-9079 (4)	3K-9770 (4)
J350	173-5427	173-5426	6V-6535 (4)	3K-9770 (4)
J400, J460	173-5429	173-5428	5P-8823 (4)	3K-9770 (4)

Ground Engaging Tools - Loader Tips

Tips

Cat loader bucket tips are side pinned for excellent tip retention and quick, easy tip changing. The pin hole is located through the tip sides which are the areas of least wear.



Long Tip

- The best choice for most applications.
- Made of longer wearing DH-3 steel for 988 and 992 sizes.



Short Tip

- Provide more strength.
- Contain less wear material.



Utility Tip

- For use in utility applications.



Penetration Tip

- Provide better penetration.
- Contain less wear material.



Heavy Duty Long Tip

- Contain more wear material than Abrasion Tip.
- Provide greater strength than Long Tip.
- Provide better penetration due to a streamlined-profile.



Heavy Duty Long Life Tip

- Increase wear life 2 to 5 times more than the Heavy Duty Long Tip.
- Provide better productivity because they get sharper as they wear.



Heavy Duty Abrasion Tip

- Contain the greatest amount of wear material.
- Provide good strength.
- Provide good penetration.

Ground Engaging Tools - Loader Tips



Heavy Duty Penetration Tip

- Use in high impact, hard-to-penetrate material.
- Longer wear life.
- Stays sharp.

Tips

	J200	J225	J250	J300	J350	J400	J450/ J460	J550	J600	J700	J800
Long	1U-3202	6Y-3222	1U-3252	1U-3302	1U-3352	7T-3402	9W-8452	9W-8552	6I-6602	4T-4702	
Short		6Y-6221	1U-3251	1U-3301	1U-3351	7T-3401	9W-8451	9W-8551	6I-6601		
Utility	7T-8202										
Penetration	1U-3209	6Y-8229	9J-4259	9J-4309	9J-4359	6Y-7409	9W-8459	9W-8559	7I-7609	4T-4709	117-6809
Heavy Duty Long		8E-4222	9N-4252	9N-4302	9N-4352	8E-4402	9N-4452	9N-4552	7Y-0602	9U-9702	6I-8802
Heavy Duty Long Life			135-8252	125-8302	135-9352	116-7402	101-9054	101-9055	107-8602	107-2001	
Heavy Duty Abrasion		6Y-6223	9N-4253	9N-4303	9N-4353	7T-3403	9N-4453	6Y-2553	6I-6603	9U-9703	6I-8803
Heavy Duty Penetration				135-9300	144-1358	135-9400	138-6451	138-6552	135-9600	135-9700	135-9800
Pin	8E-6208	132-4762	132-4763	132-4766	114-0358	116-7408	114-0468*	107-3378	113-9608	113-4708	134-1808
Retainer	8E-6209	149-5733	149-5733	149-5733	114-0359	116-7409	107-3469*	107-8559	113-9609	113-4709	134-1809

* Some older models have a 0.75" (19 mm) pin diameter, instead of the current 0.875" (22 mm) pin diameter. For those older models which have the 0.75" (19 mm) pin diameter, use a 6Y-2527 pin and a 8E-6359 retainer.

Ground Engaging Tools - Loader Tips



Bolt-On Unitooth Tips

- Improves penetration where breakage is not a problem.
- Tip and adapter are one integrated piece for easy installation and lower initial costs.
- For use in nonabrasive materials.

TIP SIZE	MODEL
J200	910, 931, 914G, 935, IT12, IT14G
J250	916, 920, 924, 926, 928, 930, 936, 938, 939, 941, 943, 951, 953, IT18, IT28
J300*	944, 950, 953B
J300**	950B, 955, 960F, 963
J300***	966C
J350	960F, 966D, 970F, 973, 977

Bolt-On Unitooth Tip Chart

UNITOOTH COMPONENTS	J200	J250	J300*	J300**	J300***	J350
Unitooth Center Tip	8J-6207	1U-1857	1U-1877	8E-1637	1U-1877	6Y-0649
Unitooth One Bolt Corner Tip (lh)	1U-1868	1U-1858	1U-1878	1U-1878	1U-1888	1U-1888
Unitooth One Bolt Corner Tip (rh)	1U-1869	1U-1859	1U-1879	1U-1879	1U-1889	1U-1889
Unitooth Two Bolt Corner Tip (lh)		6I-8388	8E-8608	8E-8608	8E-5318	8E-5318
Unitooth Two Bolt Corner Tip (rh)		6I-8389	8E-8609	8E-8609	8E-5319	8E-5319

- * 25 mm edge.
 ** 32 mm edge.
 *** 32 mm edge (bigger bolts).

Ground Engaging Tools - Loader Adapters

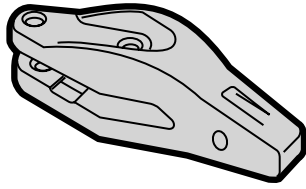

Bolt-On Center Adapters

TIP SIZE	MODEL	BOLT-ON ADAPTER (center)	BOLT	NUT
J200	---	9J-4207	5J-4771	2J-3506
J225	---	6Y-6227	1J-6762	2J-3506
J250	---	1U-0257	8J-2928	8J-2933
J300	944, 950, 953B, 953C	1U-0307	8J-2928	8J-2933
	950B, 950E, 950F	4T-4307	5P-8136	8J-2933
	966C	3G-9307	5P-8361	5P-8362
J350	960F, 966D, 966E, 966F, 970F	3G-3357	5P-8361	5P-8362
	963B, 973, 977	3G-7357	6V-8360	5P-8362
	980A, 980B, 980C, 980G, 980F	1U-1357	5P-8361	5P-8362
J460	---	8E-2467	5P-8361	5P-8362

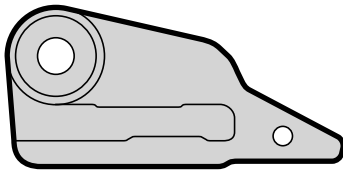

One-Bolt Corner Adapters

TIP SIZE	MODEL	ONE-BOLT ADAPTER		BOLT	NUT
		(lh)	(rh)		
J200	---	1U-2208	1U-2209	6F-0196	2J-3505
J225	---	6Y-6228	6Y-6229	6F-0196	2J-3505
J250	---	3G-4258	3G-4259	4J-9058	8J-2933
J300	944, 950, 950B, 950E, 950F, 960F	3G-4308	3G-4309	6V-6535	5P-8362
	953B, 953C, 963	3G-4308	3G-4309	4J-9058	8J-2933
	966C	3G-8308	3G-8309	5P-8823	5P-8362
J350	960F, 963B, 966D, 966E, 966F	3G-5358	3G-5359	5P-8823	5P-8362
	970F, 973, 977	3G-5358	3G-5359	5P-8823	5P-8362
	980A, 980B, 980C, 980F, 980G	1U-1358	1U-1359	6V-8360	5P-8362
J460	---	8E-2469	8E-2468	6V-8360	5P-8362

Ground Engaging Tools - Loader Adapters

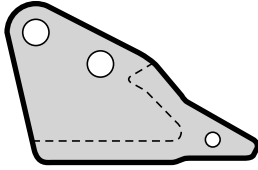

Two-Bolt Corner Adapters

TIP SIZE	MODEL	TWO-BOLT ADAPTER		BOLT	BOLT	NUT
		(lh)	(rh)			
J250	920, 924F, 926, 928, 928F, 928G	6I-9250	6I-9251	4J-9058	4F-4042	2J-3507
	930, 936, 936E, 936F, 938F	6I-9250	6I-9251	4J-9058	4F-4042	2J-3507
	939, 941, 943, 951, 953	6I-9250	6I-9251	4J-9208	4F-4042	2J-3507
	IT18, IT24F, IT28	6I-9250	6I-9251	4J-9058	4F-4042	2J-3507
J300	944, 950, 953B, 953C, 963	8E-5308	8E-5309	8T-9079	6V-8360	3K-9770
	950B, 950E, 950F, 960F	8E-5308	8E-5309	8T-9079	5P-8823	3K-9770
J350	---	8E-5358	8E-5359	5P-8361	6V-6535	3K-9770

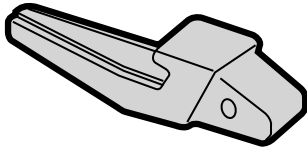

Bottom Strap Adapters

TIP SIZE	MODEL	BOTTOM STRAP ADAPTER		
		(lh)	(center)	(rh)
J200	---	---	8J-7525	---
J250	---	---	3G-0169	---
J300	---	---	9J-8929	---
J350	---	1U-1352	1U-1350	1U-1351
J460	---	8E-5466	8E-5464	8E-5465
J550	---	9J-3664	9J-3662	9J-3663

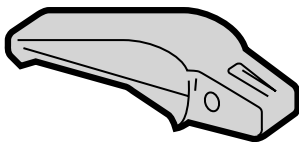

Flushmount Adapters

TIP SIZE	MODEL	FLUSHMOUNT ADAPTER		
		(lh)	(center)	(rh)
J200	---	---	4T-1204	---
J250	---	---	1U-1254	---
J300	---	---	1U-1304	---
J350	---	1U-1356	1U-1354	1U-1355
J400	---	---	107-3404	---
J460	---	8E-0466	8E-0464	8E-0465
J550	990, 992C	3G-4556	3G-4554	3G-4555
	992, 992B	7J-9556	7J-9554	7J-9555

Ground Engaging Tools - Loader Adapters

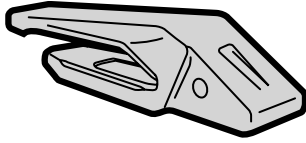

Two Strap Adapters

TIP SIZE	MODEL	TWO STRAP ADAPTER		
		(lh)	(center)	(rh)
J400	---	9U-9478	9U-9476	9U-9477
J460	---	8E-3466	8E-3464	8E-3465
J550	---	3G-9496	3G-9494	3G-9495
J600	---	6I-8606	6I-8604	6I-8605
J700	---	4T-4706	4T-4704	4T-4705

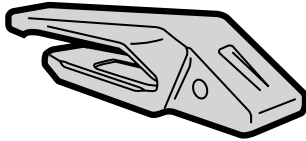

Heavy Duty Adapters

TIP SIZE	MODEL	HEAVY DUTY ADAPTER		
		(lh)	(center)	(rh)
J350	---	135-9356	135-9354	135-9355
J400	---	125-8406	125-8404	125-8405
J460	---	114-0466	114-0464	114-0465
J550	---	107-3556	107-3554	107-3555
J600	---	119-8606	119-8604	119-8605
J700	---	133-0706	133-0704	133-0705
J700	994		100-7416	
J800	---	---	6I-8804	---

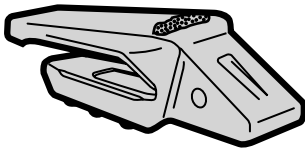

Heavy Duty A.R.M. Adapters

TIP SIZE	MODEL	HEAVY DUTY A.R.M. ADAPTER		
		(lh)	(center)	(rh)
J400	---	125-8409	125-8407	125-8408
J460	---	116-7466	116-7464	116-7465
J550	---	112-2556	112-2554	112-2555
J600	---	119-8606	119-8604	119-8605
J700	---	133-0708	133-0707	133-0709

Ground Engaging Tools - Loader Adapters

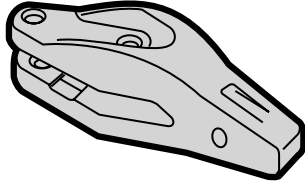

Upsize Bolt-On Center Adapters

TIP SIZE	EDGE THICKNESS		MODEL	UPSIZED TIP SIZE	UPSIZED BOLT-ON ADAPTER (center)		UPSIZED BOLT	UPSIZED NUT
	(in)	(mm)						
J200	0.75	19	910, 914G, 939	J225	6Y-6227	5J-4771	2J-3506	
J250	1.00	25	916, 920, 926, 930, 936	J300	1U-0307	8J-2928	8J-2933	
	1.00	25	941, 943, 951, 953	J300	1U-0307	8J-2928	8J-2933	
	1.00	25	IT18, IT28	J300	1U-0307	8J-2928	8J-2933	
J300	1.25	32	966C	J350	3G-7357	6V-8360	5P-8362	
J350	1.50	38	966D, 970F, 973, 977	J460	8E-3467	5P-8361	5P-8362	
	1.75	45	980	J460	8E-2467	5P-8361	5P-8362	

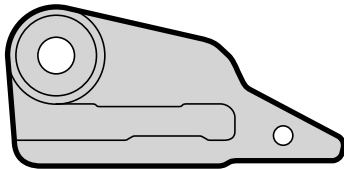

Upsize One-Bolt Corner Adapters

TIP SIZE	EDGE THICKNESS		MODEL	UPSIZED TIP SIZE	UPSIZED ONE BOLT ADAPTER		UPSIZED BOLT	UPSIZED NUT
	(in)	(mm)			(lh)	(rh)		
J200	0.75	19	910, 914G, 939	J225	6Y-6228	6Y-6229	6F-0196	2J-3505
J250	1.00	25	916, 920, 926, 930, 936	J300	3G-4308	3G-4309	6V-6535	5P-8362
	1.00	25	941, 943, 951, 953	J300	3G-4308	3G-4309	6V-6535	5P-8362
	1.00	25	IT18, IT28	J300	3G-4308	3G-4309	6V-6535	5P-8362
J300	1.25	32	966C	J350	3G-5358	3G-5359	5P-8823	5P-8362
J350	1.50	38	966, 973, 977	J460	8E-3469	8E-3468	5P-8823	6V-8360
	1.75	45	980	J460	8E-2469	8E-2468	6V-8360	5P-8362

Ground Engaging Tools - Loader Adapters / Protectors

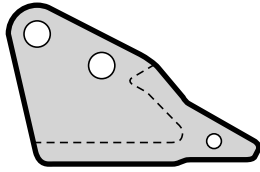

Upsize Two-Bolt Corner Adapters

TIP SIZE	EDGE THICKNESS		MODEL	UPSIZED TIP SIZE	UPSIZED TWO-BOLT ADAPTER		UPSIZED BOLT	UPSIZED BOLT	UPSIZED NUT
	(in)	(mm)			(lh)	(rh)			
J250	1.00	25	916, 920, 926, 930	J300	8E-5308	8E-5309	8T-9079	6V-8360	3K-9770
	1.00	25	941, 943, 951, 953	J300	8E-5308	8E-5309	8T-9079	6V-8360	3K-9770
J300	1.25	32	950, 953, 955, 963	J350	8E-5358	8E-5359	5P-8361	6V-6535	3K-9770

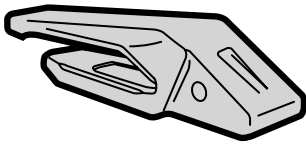

Upsize Two Strap Adapters

TIP SIZE	EDGE THICKNESS		MODEL	UPSIZED TIP SIZE	UPSIZED TWO-STRAP ADAPTER		
	(in)	(mm)			(lh)	(center)	(rh)
J400	1.75	45	980	J450	4T-8456	4T-8454	4T-8455
J460	2.00	51	983, 988	J550	4T-7556	4T-7554	4T-7555
J550	2.50	64	992	J700	9W-9706	9W-9704	9W-9705
J700	4.00	100	994	J800		6I-8804	



GROUND ENGAGING TOOLS - MOTOR GRADER

GraderBit Systems	310
GraderBit System Adapters	311
Cutting Edges	313
Moldboard End Bits	320
Overlay End Bits	321

Ground Engaging Tools - Motor Grader Bits

GraderBit Systems

The Caterpillar GraderBit System is a road maintenance edge that lowers owning and operating costs by increasing productivity, decreasing blade maintenance, and reducing downtime.

The Caterpillar GraderBit System works by using special adapters and graderbits instead of a conventional cutting edge. The adapters are bolted onto the moldboard, and then, the graderbits are secured into the adapter using snap rings. Different combinations of graderbit sizes and types allow you to customize the edge pattern to deliver the best performance in any surface condition, including mining haul roads, public roads, farm roads, logging roads, and even paved road.

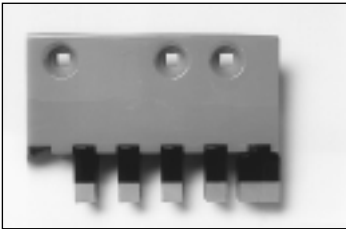

Standard Bit Arrangement

- Made from tungsten carbide wear material for better penetration and wear life than conventional cutting edges.
- Available in an optional serrated design.

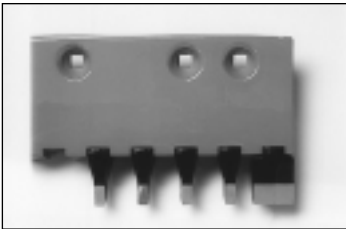

Sharp Bit Arrangement

- Made from tungsten carbide wear material for better penetration and wear life than conventional cutting edges.
- Available in an optional serrated design.

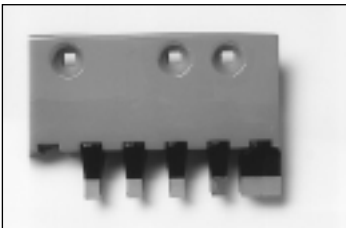

Penetration Bit Arrangement

- Made from tungsten carbide wear material for better penetration and wear life than conventional cutting edges.
- Available in an optional serrated design.

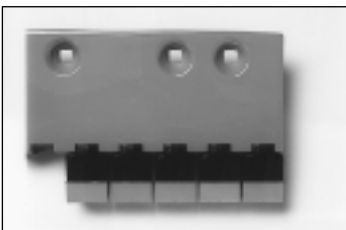

Wide Bit Arrangement

- Made from tungsten carbide wear material for better penetration and wear life than conventional cutting edges.
- Available in an optional serrated design for the 14 and 16 Motor Graders.
- Available in a continuous design with narrow gap adapters.

MODEL	GAP SIZE	EDGE LENGTH		GRADERBIT ARRANGEMENT*				SNAP RING RETAINER**
		(ft)	(m)	STANDARD	SHARP	PENETRATION	WIDE	
All	Narrow	3.00	0.914	6Y-4339 (15)	105-5183 (15)	105-5180 (15)	6Y-4340 (15)	068-4860 (15)
		4.00	1.219	6Y-4339 (20)	105-5183 (20)	105-5180 (20)	6Y-4340 (20)	068-4860 (15)
14, 16	Wide	3.00	0.914	6Y-4339 (12)	105-5183 (12)	105-5180 (12)	6Y-4340 (12)	068-4860 (15)
		4.00	1.219	6Y-4339 (16)	105-5183 (16)	105-5180 (16)	6Y-4340 (16)	068-4860 (15)

* Includes snap ring retainer.

** Uses 1P-1860 snap ring pliers.

Ground Engaging Tools - Motor Grader Adapters

GraderBit System Adapters

MODEL	GAP SIZE	EDGE LENGTH		MOLDBOARD LENGTH		ADAPTER PART NUMBER	BOLTS	NUTS
		(ft)	(m)	(ft)	(m)			
14, 16, 140H (3/4" bolts), 143H (3/4" bolts)	Narrow	3.00	0.914	10.00	3.050	159-0318 (2)	5J-4771 (19)	2J-3506 (19)
				11.00	3.350	159-0318	5J-4771 (21)	2J-3506 (21)
				13.00	3.960	159-0318 (3)	5J-4771 (24)	2J-3506 (24)
				14.00	4.270	159-0318 (2)	5J-4771 (30)	2J-3506 (30)
				15.00	4.570	159-0318	5J-4771 (28)	2J-3506 (28)
		4.00	1.219	10.00	3.050	159-0317	5J-4771 (19)	2J-3506 (19)
				11.00	3.350	159-0317 (2)	5J-4771 (21)	2J-3506 (21)
				12.00	3.660	159-0317 (3)	5J-4771 (23)	2J-3506 (23)
				13.00	3.960	159-0317	5J-4771 (24)	2J-3506 (24)
				14.00	4.270	159-0317 (2)	5J-4771 (30)	2J-3506 (30)
				15.00	4.570	159-0317 (3)	5J-4771 (28)	2J-3506 (28)
				16.00	4.880	159-0317 (4)	5J-4771 (36)	2J-3506 (36)
	Wide	3.00	0.914	10.00	3.050	159-0313 (2)	5J-4771 (19)	2J-3506 (19)
				11.00	3.350	159-0313	5J-4771 (21)	2J-3506 (21)
				13.00	3.960	159-0313 (3)	5J-4771 (24)	2J-3506 (24)
				14.00	4.270	159-0313 (2)	5J-4771 (30)	2J-3506 (30)
				15.00	4.570	159-0313	5J-4771 (28)	2J-3506 (28)
		4.00	1.219	10.00	3.050	159-0314	5J-4771 (19)	2J-3506 (19)
				11.00	3.350	159-0314 (2)	5J-4771 (21)	2J-3506 (21)
				12.00	3.660	159-0314 (3)	5J-4771 (23)	2J-3506 (23)
				13.00	3.960	159-0314	5J-4771 (24)	2J-3506 (24)
				14.00	4.270	159-0314 (2)	5J-4771 (30)	2J-3506 (30)
				15.00	4.570	159-0314 (3)	5J-4771 (28)	2J-3506 (28)
				16.00	4.880	159-0314 (4)	5J-4771 (36)	2J-3506 (36)
All except 14, 16, 140H (5/8" bolts), 143H (5/8" bolts)	Narrow	3.00	0.914	10.00	3.050	159-0311 (2)	3F-5108 (19)	4K-0367 (19)
				11.00	3.350	159-0311	3F-5108 (21)	4K-0367 (21)
				13.00	3.960	159-0311(3)	3F-5108 (24)	4K-0367 (24)
				14.00	4.270	159-0311 (2)	3F-5108 (30)	4K-0367 (30)
				15.00	4.570	159-0311	3F-5108 (28)	4K-0367 (28)
		4.00	1.219	10.00	3.050	159-0312	3F-5108 (19)	4K-0367 (19)
				11.00	3.350	159-0312 (2)	3F-5108 (21)	4K-0367 (21)
				12.00	3.660	159-0312 (3)	3F-5108 (23)	4K-0367 (23)
				13.00	3.960	159-0312	3F-5108 (24)	4K-0367 (24)
				14.00	4.270	159-0312 (2)	3F-5108 (30)	4K-0367 (30)
				15.00	4.570	159-0312 (3)	3F-5108 (28)	4K-0367 (28)
				16.00	4.880	159-0312 (4)	3F-5108 (36)	4K-0367 (36)
	Wide	3.00	0.914	10.00	3.050	159-0315 (2)	3F-5108 (19)	4K-0367 (19)
				11.00	3.350	159-0315	3F-5108 (21)	4K-0367 (21)
				13.00	3.960	159-0315 (3)	3F-5108 (24)	4K-0367 (24)
				14.00	4.270	159-0315 (2)	3F-5108 (30)	4K-0367 (30)
				15.00	4.570	159-0315	3F-5108 (28)	4K-0367 (28)
		4.00	1.219	10.00	3.050	159-0316	3F-5108 (19)	4K-0367 (19)
				11.00	3.350	159-0316 (2)	3F-5108 (21)	4K-0367 (21)

Ground Engaging Tools - Motor Grader Adapters

GraderBit System Adapters

MODEL	GAP SIZE	EDGE LENGTH		MOLDBOARD LENGTH		ADAPTER PART NUMBER	BOLTS	NUTS
		(ft)	(m)	(ft)	(m)			
All except 14, 16, 140H (5/8" bolts), 143H (5/8" bolts)	Wide	4.00	1.219	12.00	3.660	159-0316 (3)	3F-5108 (23)	4K-0367 (23)
				13.00	3.960	159-0316	3F-5108 (24)	4K-0367 (24)
				14.00	4.270	159-0316 (2)	3F-5108 (30)	4K-0367 (30)
				15.00	4.570	159-0316 (3)	3F-5108 (28)	4K-0367 (28)
				16.00	4.880	159-0316 (4)	3F-5108 (36)	4K-0367 (36)

Ground Engaging Tools - Motor Grader Cutting Edges

Cutting Edges

Caterpillar Motor Grader Cutting Edges are made of DH2 alloy steel, SAE specification high carbon steel, or Tungsten Carbide and are double bevel shaped for improved penetration.

DH2 Through-Hardened Edges are heat treated for longer wear life and greater breakage resistance than surface hardened edges or high carbon steel edges. DH2 Through-Hardened Edges have a lifetime warranty against breakage.

High Carbon Edges are wear resistant and intended for light duty applications.

Tungsten Carbide Edges provide twenty times more wear life in low impact, high wear applications.

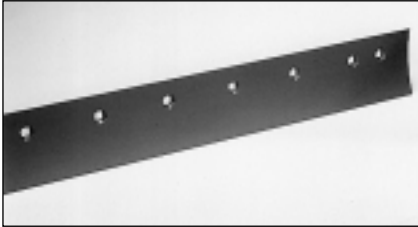

Curved Cutting Edges

- Provide best penetration.
- For use in most construction and finish grading applications.

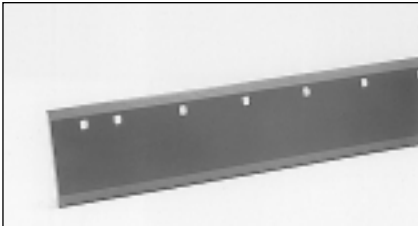

Flat Cutting Edges

- Provide greater strength and more wear material.
- For use with large machines in road maintenance and pioneering applications.



Serrated Cutting Edges

- Provide better penetration of frozen or hard-packed materials.
- For use in gravel raking and spreading applications, as well as other special applications.

EDGE WIDTH (in) (mm)		EDGE THICKNESS (in) (mm)		EDGE LENGTH (ft) (m)		EDGE TYPE	STEEL TYPE	BOLT SIZE	EDGE PART NUMBER	BOLTS	NUTS			
4.75	121	0.75	19	2.00	0.610	Curved	Tungsten Carbide	0.62	174-7952	3F-5108 (5)	4K-0367 (5)			
								0.75	174-7953	4F-7827 (5)*	2J-3506 (5)			
				3.00	0.914	Curved	Tungsten Carbide	0.62	174-7951	3F-5108 (7)	4K-0367 (7)			
								0.75	174-7961	4F-7827 (7)*	2J-3506 (7)			
6.00	152	0.50	13	4.00	1.219	Curved	DH2	0.62	3G-8016	3F-5108 (9)	4K-0367 (9)			
								0.75	9W-2293	3F-5108 (6)	4K-0367 (6)			
							5.00	1.524	Curved	DH2	0.62	9J-3862	3F-5108 (11)	4K-0367 (11)
											0.75	9W-2294	4F-7827 (6)*	2J-3506 (6)
				6.00	1.828	Curved	DH2	0.62	9W-2295	3F-5108 (7)	4K-0367 (7)			
								0.75	9W-2296	4F-7827 (7)*	2J-3506 (7)			
							DH2	0.62	8D-2786	3F-5108 (13)	4K-0367 (13)			
								0.75	9J-3660	4F-7827 (13)*	2J-3506 (13)			

* For a 14G Motor Grader, use 5J-4773 bolts.

For a 16G Motor Grader with a 16 ft. blade, use 5F-8933 bolts.

For a 16G Motor Grader without a 16 ft. blade, use 5J-4771 bolts.

For a 24H Motor Grader, use 1J-3527 bolts for last the last five bolts on each end of the edge.

Ground Engaging Tools - Motor Grader Cutting Edges

Cutting Edges

EDGE WIDTH (in) (mm)		EDGE THICKNESS (in) (mm)		EDGE LENGTH (ft) (m)		EDGE TYPE	STEEL TYPE	BOLT SIZE	EDGE PART NUMBER	BOLTS	NUTS
6.00	152	0.50	13	6.00	1.828	Curved	High Carbon	0.62	9W-2297	3F-5108 (8)	4K-0367 (8)
								0.75	9W-2298	4F-7827 (8)*	2J-3506 (8)
				7.00	2.133	Curved	DH2	0.62	8D-2787	3F-5108 (15)	4K-0367 (15)
								0.75	9J-3659	4F-7827 (15)*	2J-3506 (15)
							High Carbon	0.62	9W-2299	3F-5108 (9)	4K-0367 (9)
								0.75	9W-2300	4F-7827 (9)*	2J-3506 (9)
				8.00	2.438	Curved	DH2	0.62	8J-7782	3F-5108 (17)	4K-0367 (17)
								0.75	9J-3656	4F-7827 (17)*	2J-3506 (17)
							High Carbon	0.62	9W-2301	3F-5108 (10)	4K-0367 (10)
								0.75	9W-2302	4F-7827 (10)*	2J-3506 (10)
				9.00	2.743	Curved	High Carbon	0.62	4Z-8968	3F-5108 (11)	4K-0367 (11)
				10.00	3.048	Curved	High Carbon	0.62	9W-2303	3F-5108 (12)	4K-0367 (12)
		0.75	9W-2304					4F-7827 (12)*	2J-3506 (12)		
		12.00	3.658	Curved	High Carbon	0.62	9W-2305	3F-5108 (13)	4K-0367 (13)		
						0.75	9W-2306	4F-7827 (14)*	2J-3506 (14)		
		14.00	4.267	Curved	High Carbon	0.62	9W-2307	3F-5108 (16)	4K-0367 (16)		
						0.75	9W-2308	4F-7827 (16)*	2J-3506 (16)		
		0.62	16	2.00	0.610	Curved	DH2	0.62	9W-1835	3F-5108 (4)	4K-0367 (4)
								0.75	9W-2326	4F-7827 (6)*	2J-3506 (6)
				4.00	1.219	Curved	High Carbon	0.62	9W-2325	3F-5108 (6)	4K-0367 (6)
								0.75	9W-2326	4F-7827 (6)*	2J-3506 (6)
				5.00	1.524	Curved	DH2	0.62	7D-4508	3F-5108 (11)	4K-0367 (11)
								0.75	9W-2327	4F-7827 (7)*	2J-3506 (7)
							High Carbon	0.62	7T-1640	3F-5108 (7)	4K-0367 (7)
								0.75	9W-2327	4F-7827 (7)*	2J-3506 (7)
				6.00	1.828	Curved	DH2	0.62	5D-9553	3F-5108 (13)	4K-0367 (13)
								0.75	9J-3657	4F-7827 (13)*	2J-3506 (13)
							High Carbon	0.62	7T-1633	3F-5108 (8)	4K-0367 (8)
0.75	7T-1637							4F-7827 (8)*	2J-3506 (8)		
7.00	2.133			Curved	DH2	0.62	5D-9554	3F-5108 (15)	4K-0367 (15)		
						0.75	9J-3658	4F-7827 (15)*	2J-3506 (15)		
					High Carbon	0.62	7T-1645	3F-5108 (9)	4K-0367 (9)		
						0.75	7T-1626	4F-7827 (9)*	2J-3506 (9)		
8.00	2.438			Curved	DH2	0.62	8J-4043	3F-5108 (17)	4K-0367 (17)		
						0.75	9J-3655	4F-7827 (17)*	2J-3506 (17)		
		High Carbon	0.62		7T-1632	3F-5108 (10)	4K-0367 (10)				
			0.75		7T-1629	4F-7827 (10)*	2J-3506 (10)				
11.00	3.353	Curved	High Carbon	0.62	4Z-8652	3F-5108 (13)	4K-0367 (13)				
12.00	3.658	Curved	High Carbon	0.62	4Z-8653	3F-5108 (14)	4K-0367 (14)				
0.75	19	4.00	1.219	Curved	High Carbon	0.62	9W-2331	3F-5108 (6)	4K-0367 (6)		
						0.75	9W-2332	4F-7827 (6)*	2J-3506 (6)		
5.00	1.524	Curved	DH2	0.62	3G-7966	3F-5108 (11)	4K-0367 (11)				

* For a 14G Motor Grader, use 5J-4773 bolts.

For a 16G Motor Grader with a 16 ft. blade, use 5F-8933 bolts.

For a 16G Motor Grader without a 16 ft. blade, use 5J-4771 bolts.

For a 24H Motor Grader, use 1J-3527 bolts for last the last five bolts on each end of the edge.

Ground Engaging Tools - Motor Grader Cutting Edges

Cutting Edges

EDGE WIDTH (in) (mm)		EDGE THICKNESS (in) (mm)		EDGE LENGTH (ft) (m)		EDGE TYPE	STEEL TYPE	BOLT SIZE	EDGE PART NUMBER	BOLTS	NUTS				
8.00	203	0.50	13	8.00	2.438	Curved	High Carbon	0.75	9W-2318	4F-7827 (10)*	2J-3506 (10)				
						10.00	3.048	Curved	High Carbon	0.62	9W-2319	3F-5108 (12)	4K-0367 (12)		
						12.00	3.658	Curved	High Carbon	0.75	9W-2320	4F-7827 (12)*	2J-3506 (12)		
										0.62	9W-2321	3F-5108 (14)	4K-0367 (14)		
						14.00	4.267	Curved	High Carbon	0.75	9W-2322	4F-7827 (14)*	2J-3506 (14)		
										0.62	9W-2323	3F-5108 (16)	4K-0367 (16)		
										0.75	9W-2324	4F-7827 (16)*	2J-3506 (16)		
										0.62	109-3137	3F-5108 (5)	4K-0367 (5)		
						0.62	16	2.00	0.610	Curved	DH2	0.75	3G-2166	4F-7827 (4)*	2J-3506 (4)
												0.62	132-1088	3F-5108 (9)	4K-0367 (9)
								4.00	1.219	Curved	DH2	0.75	134-1773	4F-7827 (9)*	2J-3506 (9)
												0.62	9W-2328	3F-5108 (6)	4K-0367 (6)
								Flat	DH2	0.75	9W-2329	4F-7827 (6)*	2J-3506 (6)		
										0.62	4Z-8119	3F-5108 (6)	4K-0367 (6)		
						5.00	1.524	Curved	DH2	0.62	7D-4509	3F-5108 (11)	4K-0367 (11)		
										0.62	7T-1641	3F-5108 (7)	4K-0367 (7)		
								Flat	DH2	0.75	9W-2330	4F-7827 (7)*	2J-3506 (7)		
										0.62	4T-2967	3F-5108 (11)	4K-0367 (11)		
										0.75	4Z-8120	4F-7827 (13)*	2J-3506 (13)		
										0.62	5D-9562	3F-5108 (13)	4K-0367 (13)		
						6.00	1.828	Curved	DH2	0.75	9J-7701	4F-7827 (13)*	2J-3506 (13)		
										0.62	7T-1636	3F-5108 (8)	4K-0367 (8)		
								Flat	DH2	0.75	7T-1639	4F-7827 (8)*	2J-3506 (8)		
										0.62	4T-2968	3F-5108 (13)	4K-0367 (13)		
										0.75	4T-2971	4F-7827 (13)*	2J-3506 (13)		
										0.62	5D-9561	3F-5108 (15)	4K-0367 (15)		
						7.00	2.133	Curved	DH2	0.75	7D-1158	4F-7827 (15)*	2J-3506 (15)		
										0.62	7T-1643	3F-5108 (9)	4K-0367 (9)		
								Flat	DH2	0.75	7T-1624	4F-7827 (9)*	2J-3506 (9)		
										0.62	4T-2969	3F-5108 (15)	4K-0367 (15)		
										0.75	4T-2970	4F-7827 (15)*	2J-3506 (15)		
										0.62	5D-9731	3F-5108 (17)	4K-0367 (17)		
						8.00	2.438	Curved	DH2	0.75	8J-9821	4F-7827 (17)*	2J-3506 (17)		
										0.62	7T-1631	3F-5108 (10)	4K-0367 (10)		
								Flat	DH2	0.75	7T-1628	4F-7827 (10)*	2J-3506 (10)		
										0.62	4T-2966	3F-5108 (17)	4K-0367 (17)		
								0.75	4T-9603	4F-7827 (17)*	2J-3506 (17)				
								0.62	6G-8623	3F-5108 (4)	4K-0367 (4)				
		0.75	19	2.00	0.610	Curved	DH2	0.75	3G-2165	4F-7827 (4)*	2J-3506 (4)				
								0.62	4Z-8129	3F-5108 (11)	4K-0367 (11)				
				3.00	0.914	Flat	DH2	0.62							

- * For a 14G Motor Grader, use 5J-4773 bolts.
- For a 16G Motor Grader with a 16 ft. blade, use 5F-8933 bolts.
- For a 16G Motor Grader without a 16 ft. blade, use 5J-4771 bolts.
- For a 24H Motor Grader, use 1J-3527 bolts for last the last five bolts on each end of the edge.

Ground Engaging Tools - Motor Grader Cutting Edges

Cutting Edges

EDGE WIDTH (in) (mm)		EDGE THICKNESS (in) (mm)		EDGE LENGTH (ft) (m)		EDGE TYPE	STEEL TYPE	BOLT SIZE	EDGE PART NUMBER	BOLTS	NUTS
8.00	203	0.75	19	4.00	1.219	Curved	DH2	0.62	132-1087	3F-5108 (9)	4K-0367 (9)
								0.75	109-3124	4F-7827 (9)*	2J-3506 (9)
							High Carbon	0.62	9W-2338	3F-5108 (6)	4K-0367 (6)
						0.75		9W-2339	4F-7827 (6)*	2J-3506 (6)	
						Curved Serrated	DH2	0.62	8D-3428	3F-5108 (9)	4K-0367 (9)
								0.75	8J-8255	4F-7827 (9)*	2J-3506 (9)
				5.00	1.524	Curved	DH2	0.62	9W-6252	3F-5108 (11)	4K-0367 (11)
								0.75	4Z-8131	4F-7827 (7)*	2J-3506 (7)
							High Carbon	0.62	9W-2340	3F-5108 (7)	4K-0367 (7)
						0.75		9W-2341	4F-7827 (7)*	2J-3506 (7)	
						Curved Serrated	DH2	0.62	8D-3429	3F-5108 (11)	4K-0367 (11)
								0.75	8J-8256	4F-7827 (11)*	2J-3506 (11)
		Flat	DH2	0.62	4T-3034	3F-5108 (11)	4K-0367 (11)				
				0.75	4T-3033	4F-7827 (13)*	2J-3506 (13)				
		6.00	1.828	Curved	DH2	0.62	5D-9558	3F-5108 (13)	4K-0367 (13)		
						0.75	7D-1576	4F-7827 (13)*	2J-3506 (13)		
					High Carbon	0.62	7T-1634	3F-5108 (8)	4K-0367 (8)		
				0.75		7T-1638	4F-7827 (8)*	2J-3506 (8)			
				Curved Serrated	DH2	0.62	132-1072	3F-5108 (13)	4K-0367 (13)		
						0.75	4T-3007	3F-5108 (13)	4K-0367 (13)		
		7.00	2.133	Curved	DH2	0.62	5D-9559	3F-5108 (15)	4K-0367 (15)		
						0.75	7D-1577	4F-7827 (15)*	2J-3506 (15)		
					High Carbon	0.62	7T-1623	3F-5108 (9)	4K-0367 (9)		
				0.75		7T-1625	4F-7827 (9)*	2J-3506 (9)			
Curved Serrated	DH2			0.62	4Z-9020	3F-5108 (15)	4K-0367 (15)				
				0.75	4T-3036	3F-5108 (15)	4K-0367 (15)				
Flat	DH2	0.62	4T-3032	4F-7827 (15)*	2J-3506 (15)						
		0.75	4T-3032	4F-7827 (15)*	2J-3506 (15)						
8.00	2.438	Curved	DH2	0.62	5D-9732	3F-5108 (17)	4K-0367 (17)				
				0.75	7D-1949	4F-7827 (17)*	2J-3506 (17)				
				High Carbon	0.62	7T-1630	3F-5108 (10)	4K-0367 (10)			
			0.75		7T-1627	4F-7827 (10)*	2J-3506 (10)				
			Curved Serrated	DH2	0.62	132-1073	3F-5108 (17)	4K-0367 (17)			
					0.75	4T-3035	3F-5108 (17)	4K-0367 (17)			
		1.00	25	Curved	DH2	0.75	109-3150	4F-7827 (9)*	2J-3506 (9)		
						0.75	4T-3512	4F-7827 (9)*	2J-3506 (9)		
					Flat	DH2	0.62	135-9692	3F-5108 (11)	4K-0367 (11)	
				0.75			4Z-8926	4F-7827 (13)*	2J-3506 (13)		
				Flat Serrated	DH2	0.75	7T-3600	4F-7827 (9)*	2J-3506 (9)		
						0.62	4T-2240	3F-5108 (11)	4K-0367 (11)		

* For a 14G Motor Grader, use 5J-4773 bolts.

For a 16G Motor Grader with a 16 ft. blade, use 5F-8933 bolts.

For a 16G Motor Grader without a 16 ft. blade, use 5J-4771 bolts.

For a 24H Motor Grader, use 1J-3527 bolts for last the last five bolts on each end of the edge.

Ground Engaging Tools - Motor Grader Cutting Edges

Cutting Edges

EDGE WIDTH (in) (mm)		EDGE THICKNESS (in) (mm)		EDGE LENGTH (ft) (m)		EDGE TYPE	STEEL TYPE	BOLT SIZE	EDGE PART NUMBER	BOLTS	NUTS		
8.00	203	1.00	25	5.00	1.524	Curved Serrated	DH2	0.75	4T-3511	4F-7827 (11)*	2J-3506 (11)		
						Flat	DH2	0.62	7T-3497	3F-5108 (11)	4K-0367 (11)		
						Flat Serrated	DH2	0.75	7T-3601	4F-7827 (11)*	2J-3506 (11)		
				6.00	1.828	Curved	DH2	0.62	4T-2244	3F-5108 (13)	4K-0367 (13)		
							Flat	DH2	0.75	4T-2231	4F-7827 (13)*	2J-3506 (13)	
								DH2	0.62	7T-3499	3F-5108 (13)	4K-0367 (13)	
						7.00	2.133	Curved	DH2	0.75	7T-3493	4F-7827 (13)*	2J-3506 (13)
									DH2	0.62	4T-2242	3F-5108 (15)	4K-0367 (15)
								Flat	DH2	0.75	4T-2233	4F-7827 (15)*	2J-3506 (15)
				DH2	0.62	7T-3498	3F-5108 (15)		4K-0367 (15)				
				8.00	2.438	Curved	DH2	0.75	7T-3494	4F-7827 (15)*	2J-3506 (15)		
							DH2	0.62	4T-2237	3F-5108 (17)	4K-0367 (17)		
							DH2	0.75	4T-2236	4F-7827 (17)*	2J-3506 (17)		
						Flat	DH2	0.62	7T-3496	3F-5108 (17)	4K-0367 (17)		
							DH2	0.75	7T-3495	4F-7827 (17)*	2J-3506 (17)		
10.00	254	1.00	25	4.00	1.219	Flat Serrated	DH2	0.75	4T-8800	4F-7827 (9)*	2J-3506 (9)		
						Flat Serrated	DH2	0.75	4T-8801	4F-7827 (11)*	2J-3506 (11)		
						Flat	DH2	0.75	4T-6502	4F-7827 (13)*	2J-3506 (13)		
				7.00	2.133	Flat	DH2	0.75	4T-6508	4F-7827 (15)*	2J-3506 (15)		
						Flat Serrated	DH2	0.75	4Z-8055	4F-7827 (15)*	2J-3506 (15)		
				8.00	2.438	Flat	DH2	0.75	4T-6511	4F-7827 (17)*	2J-3506 (17)		
							DH2	0.75	4Z-8056	4F-7827 (17)*	2J-3506 (17)		
						Flat Serrated	DH2	0.75	4T-8316	4F-7827 (15)*	2J-3506 (15)		
							DH2	0.75	4Z-8346	4F-7827 (15)*	2J-3506 (15)		
				1.38	35	7.00	2.133	Flat	DH2	0.75	4T-8317	4F-7827 (17)*	2J-3506 (17)
								Flat Serrated	DH2	0.75	100-4581	4F-7827 (17)*	2J-3506 (17)
						8.00	2.438	Flat	DH2	0.75	104-3628	4F-7827 (17)*	2J-3506 (17)
				Flat Serrated	DH2			0.75	104-3631	4F-7827 (17)*	2J-3506 (17)		
				1.77	45	8.00	2.438	Flat	DH2	0.75	104-3628	4F-7827 (17)*	2J-3506 (17)
								Flat Serrated	DH2	0.75	104-3631	4F-7827 (17)*	2J-3506 (17)
1.75	45	8.00	2.438	Flat Serrated	DH2	0.75	104-3631	4F-7827 (17)*	2J-3506 (17)				
				Flat	DH2	0.75	104-3628	4F-7827 (17)*	2J-3506 (17)				
				Flat Serrated	DH2	0.75	104-3631	4F-7827 (17)*	2J-3506 (17)				
11.00	280	1.00	25	7.00	2.133	Flat	DH2	0.75	140-6790	4F-7827 (15)*	2J-3506 (15)		
						Flat	DH2	0.75	140-6832	4F-7827 (17)*	2J-3506 (17)		
				1.38	35	8.00	2.438	Flat	DH2	0.75	132-1086	4F-7827 (17)*	2J-3506 (17)
12.00	305	1.38	35	8.00	2.438	Flat	DH2	0.75	4Z-9188	4F-7827 (17)*	2J-3506 (17)		
						Flat	DH2	0.75	4Z-9188	4F-7827 (17)*	2J-3506 (17)		
13.00	330	1.12	28	4.00	1.219	Flat	DH2	1.00	109-3117	4J-9058 (9)*	2J-3507 (9)		
						Flat	DH2	1.00	109-3116	4J-9058 (9)*	2J-3507 (9)		
				Flat Serrated	DH2		1.00	138-6542	4J-9058 (9)*	2J-3507 (9)			
		8.00	2.438		Flat	DH2	0.75	128-2577	4F-7827 (17)*	2J-3506 (17)			
				Flat Serrated	DH2	0.75	134-1778	4F-7827 (17)*	2J-3506 (17)				
		2.38	60	4.00	1.219	Flat	DH2	1.00	132-1019	4J-9058 (9)*	2J-3507 (9)		
Flat Serrated	DH2					1.00	132-4753	4J-9058 (9)*	2J-3507 (9)				
16.00	406	1.12	28	4.00	1.219	Flat	DH2	1.00	135-9690	4J-9058 (9)*	2J-3507 (9)		

* For a 14G Motor Grader, use 5J-4773 bolts.

For a 16G Motor Grader with a 16 ft. blade, use 5F-8933 bolts.

For a 16G Motor Grader without a 16 ft. blade, use 5J-4771 bolts.

For a 24H Motor Grader, use 1J-3527 bolts for last the last five bolts on each end of the edge.

Ground Engaging Tools - Motor Grader Cutting Edges

Cutting Edges

EDGE WIDTH (in) (mm)		EDGE THICKNESS (in) (mm)		EDGE LENGTH (ft) (m)		EDGE TYPE	STEEL TYPE	BOLT SIZE	EDGE PART NUMBER	BOLTS	NUTS
16.00	406	1.75	45	4.00	1.219	Flat	DH2	1.00	138-6440	4J-9058 (9)*	2J-3507 (9)
		2.38	60	4.00	1.219	Flat	DH2	1.00	135-9349	4J-9058 (9)*	2J-3507 (9)
						Flat Serrated	DH2	1.00	135-9796	4J-9058 (9)*	2J-3507 (9)
		3.00	75	4.00	1.219	Flat	DH2	1.00	135-9576	4J-9058 (9)*	2J-3507 (9)
						Flat Serrated	DH2	1.00	135-9797	4J-9058 (9)*	2J-3507 (9)

* For a 14G Motor Grader, use 5J-4773 bolts.

For a 16G Motor Grader with a 16 ft. blade, use 5F-8933 bolts.

For a 16G Motor Grader without a 16 ft. blade, use 5J-4771 bolts.

For a 24H Motor Grader, use 1J-3527 bolts for the last five bolts on each end of the edge.

Ground Engaging Tools - Motor Grader End Bits

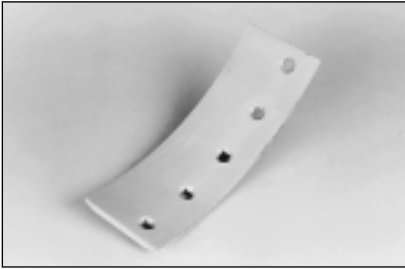

Moldboard End Bits

- Designed to protect the end of the moldboard from wear and damage.
- For use in all applications.
- For machines equipped with a power blade arrangement, please refer to the parts book for the applicable moldboard end bits.

MODEL	SERIAL NUMBER	MOLDBOARD END BIT (2) Required	BOLTS	NUTS
12, 12G	12 (All), 12G (61M1-11715)	7D-2052	3F-5108 (5)	4K-0367 (5)
12G	61M11716-UP	8E-5531	3F-5108 (5)	4K-0367 (5)
12H	All	8E-5531	3F-5108 (5)	4K-0367 (5)
14	All	7D-2084	3F-5108 (5)	4K-0367 (5)
14G	96U1-7324	9J-4406	4F-7827 (4)	2J-3506 (4)
	96U7325-UP	8E-5529	5J-4773 (5)	2J-3506 (5)
14H	All	8E-5529	5J-4773 (5)	2J-3506 (5)
16	All	9J-4408	3F-5108 (4)	4K-0367 (4)
16G	93U1-2777	9D-4881	4F-7827 (4)	2J-3506 (4)
	93U2778-UP	8E-5530	1J-6762 (5)*	2J-3506 (5)
16H	All	8E-5530	1J-6762 (5)*	2J-3506 (5)
24H	All	109-3118	1J-3527 (6)	2J-3507 (6)
112	All	7D-2052	3F-5108 (5)	4K-0367 (5)
120	87V1-6134	7D-2052	3F-5108 (5)	4K-0367 (5)
120G	87V6135-UP	8E-5531	3F-5108 (5)	4K-0367 (5)
120H	All	8E-5531	3F-5108 (5)	4K-0367 (5)
130	74V1-2292	9W-2945	3F-5108 (5)	4K-0367 (5)
130G	74V2293-UP	8E-5531	3F-5108 (5)	4K-0367 (5)
135H	All	8E-5531	3F-5108 (5)	4K-0367 (5)
140	72V1-9828	9W-2945	3F-5108 (5)	4K-0367 (5)
140G	72V9829-UP	8E-5531	3F-5108 (5)	4K-0367 (5)
140H (Blades using $\frac{3}{4}$ bolts)	All with 112-4520 and 112-4521 Blade Groups	8E-5529	5J-4773 (5)	2J-3506 (5)
140H (Blades using $\frac{5}{8}$ bolts)	All with 8X-8011 and 8X-8016 Blade Groups	8E-5531	3F-5108 (5)	4K-0367 (5)
143H (Blades using $\frac{3}{4}$ bolts)	All with 112-4520 and 112-4521 Blade Groups	8E-5529	5J-4773 (5)	2J-3506 (5)
143H (Blades using $\frac{5}{8}$ bolts)	All with 8X-8011 and 8X-8016 Blade Groups	8E-5531	3F-5108 (5)	4K-0367 (5)
160H, 163H	All	8E-5529	5J-4773 (5)	2J-3506 (5)
212	All	9J-4411	3F-5108 (4)	4K-0367 (4)

*Use the larger 5F-8933 bolt when rear moldboard reinforcing plates are used.

Ground Engaging Tools - Motor Grader End Bits



Overlay End Bits

- Designed to protect the ends of the cutting edge from excessive wear.
- Curved overlay end bits can be rotated 180° and used on the other end of the moldboard for a second wear life.
- For use on machines used for ditching where cutting edges wear fastest on the outer corners.

MODEL	SERIAL NUMBER	EDGE WIDTH		EDGE TYPE	OVERLAY END BIT		BOLTS	NUTS
		(in)	(mm)		(lh)	(rh)		
12, 12G	61M1-11715	6.00	152	Curved		6D-1904	4F-3658 (5)	4K-0367 (5)
		8.00	203	Curved		6D-1948	4F-3658 (5)	4K-0367 (5)
				Flat*	4D-5758	4D-5757	4F-3658 (5)	4K-0367 (5)
12G	61M11716-UP	4.75	121	Curved		135-9345	4F-3657 (5)	4K-0367 (5)
		6.00	152	Curved		9W-1767	4F-3658 (5)	4K-0367 (5)
		8.00	203	Curved		9W-1768	4F-3658 (5)	4K-0367 (5)
12H		4.75	121	Curved		135-9345	4F-3657 (5)	4K-0367 (5)
		6.00	152	Curved		9W-1767	4F-3658 (5)	4K-0367 (5)
		8.00	203	Curved		9W-1768	4F-3658 (5)	4K-0367 (5)
14	early models	8.00	203	Curved		7D-5583	1J-6762 (5)	2J-3506 (5)
	later models	8.00	203	Flat*	4D-5758	4D-5757	4F-3658 (5)	4K-0367 (5)
14G	96U1-7324	8.00	203	Curved		7D-9999	1J-6762 (5)	2J-3506 (5)
	96U7325-UP	8.00	203	Curved		6Y-2805	1J-6762 (5)	2J-3506 (5)
14H		8.00	203	Curved		6Y-2805	1J-6762 (5)	2J-3506 (5)
16	early models	6.00	152	Curved		7D-5582	1J-6762 (5)	2J-3506 (5)
		8.00	203	Curved		7D-5193	4F-3658 (5)	4K-0367 (5)
16G	93U1-2777	8.00	203	Curved		7D-9999	1J-6762 (5)	2J-3506 (5)
	93U2778-UP	8.00	203	Curved		6Y-2805	1J-6762 (5)	2J-3506 (5)
120, 120G	87V1-6135	6.00	152	Curved		6D-1904	4F-3658 (5)	4K-0367 (5)
		8.00	203	Curved		6D-1948	4F-3658 (5)	4K-0367 (5)
				Flat*	4D-5758	4D-5757	4F-3658 (5)	4K-0367 (5)
120G	87V6135-UP	4.75	121	Curved		135-9345	4F-3657 (5)	4K-0367 (5)
		6.00	152	Curved		9W-1767	4F-3658 (5)	4K-0367 (5)
		8.00	203	Curved		9W-1768	4F-3658 (5)	4K-0367 (5)
120H		4.75	121	Curved		135-9345	4F-3657 (5)	4K-0367 (5)
		6.00	152	Curved		9W-1767	4F-3658 (5)	4K-0367 (5)
		8.00	203	Curved		9W-1768	4F-3658 (5)	4K-0367 (5)
130, 130G	74V1-2292	6.00	152	Curved		6D-1904	4F-3658 (5)	4K-0367 (5)
		8.00	203	Curved		6D-1948	4F-3658 (5)	4K-0367 (5)
				Flat*	4D-5758	4D-5757	4F-3658 (5)	4K-0367 (5)
130G	74V2293-UP	4.75	121	Curved		135-9345	4F-3657 (5)	4K-0367 (5)
		6.00	152	Curved		9W-1767	4F-3658 (5)	4K-0367 (5)
		8.00	203	Curved		9W-1768	4F-3658 (5)	4K-0367 (5)
135H		4.75	121	Curved		135-9345	4F-3657 (5)	4K-0367 (5)
		6.00	152	Curved		9W-1767	4F-3658 (5)	4K-0367 (5)
		8.00	203	Curved		9W-1768	4F-3658 (5)	4K-0367 (5)

* Flat overlay end bits must be used with flat edges.

** Applicable for blade group numbers 8X-8011 and 8X-8016.

+ Applicable for blade group numbers 112-4520 and 112-4521.

Ground Engaging Tools - Motor Grader End Bits

Overlay End Bits

MODEL	SERIAL NUMBER	EDGE WIDTH		EDGE TYPE	OVERLAY END BIT		BOLTS	NUTS
		(in)	(mm)		(lh)	(rh)		
140, 140G	72V1-9828	6.00	152	Curved		6D-1904	4F-3658 (5)	4K-0367 (5)
		8.00	203	Curved		6D-1948	4F-3658 (5)	4K-0367 (5)
				Flat*	4D-5758	4D-5757	4F-3658 (5)	4K-0367 (5)
140G	72V9829-UP	6.00	152	Curved		9W-1767	4F-3658 (5)	4K-0367 (5)
		8.00	203	Curved		9W-1768	4F-3658 (5)	4K-0367 (5)
140H**, 143H**		4.75	121	Curved		135-9345	4F-3657 (5)	4K-0367 (5)
		6.00	152	Curved		9W-1767	4F-3658 (5)	4K-0367 (5)
		8.00	203	Curved		9W-1768	4F-3658 (5)	4K-0367 (5)
140H+, 143H+		8.00	203	Curved		6Y-2805	1J-6762 (5)	2J-3506 (5)
160H, 163H		8.00	203	Curved		6Y-2805	1J-6762 (5)	2J-3506 (5)

* Flat overlay end bits must be used with flat edges.

+ Applicable for blade group numbers 112-4520 and 112-4521.

** Applicable for blade group numbers 8X-8011 and 8X-8016.



GROUND ENGAGING TOOLS - PAVING PRODUCTS

Blocks/ HOLDERS, Soil Stabilizer Tools, Cutter Bits 324

Ground Engaging Tools - Paving Product Bits, Tools and Holders

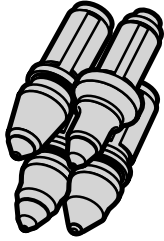

Profiler / Road Reclaimer

ITEM				
<i>Blocks / Holders</i>		<i>Part Number</i>		
Holder - Breakaway Reclaimer (3/4")		6R-3927		
Holder - Dual Bit Stabilizer (1")		113-0313		
Holder - Heavy Duty Breakaway Cold Planer/Reclaimer (3/4")		151-9941		
Holder - Heavy Duty Weld-On Cold Planer (3/4")		113-0328		
Holder - Quick Change (7/8")		117-3887		
Holder - Standard Weld-On Reclaimer (3/4")		7R-6187		
Holder - Weld-On Cold Planer (3/4")		9U-9617		
Holder - Weld-On Reclaimer/Stabilizer (7/8")		117-4076		
Mounting Block (For use with Weld-On Holders)		8T-4084		
Mounting Block - Breakaway (For use with 6R-3927 Holder)		6R-3926		
Mounting Block - Heavy Duty Breakaway (For use with 151-9941 Holder)		169-1412		
Mounting Block - Standard Reclaimer (For use with 7R-6187 Holder)		077-2848		
Holder-Quick Change (For use with 077-4018/077-2820)		107-3343		
<i>Soil Stabilizer Tools</i>		<i>Part Number</i>	<i>LH Part Number</i>	<i>RH Part Number</i>
Chopper Tools - Carbide Face			077-7343	077-4727
Chopper Tools - Hardened Steel			077-2775	077-2776
Quick Change Tools - Carbide Face		077-4018		
Quick Change Tools - Hardened Steel		077-2820		
Quick Change Tools - Holder		077-2807		
Straight Tool		077-2774		
Straight Tool Holder		077-2789		
<i>Cutter Bits</i>		<i>Part Number</i>	<i>Palet Quantity (2000)</i>	
Asphalt Bit - Heavy Duty (3/4" Shank)		140-2864	144-1238	
Asphalt Bit - Standard (3/4" Shank)		138-0697	144-1239	
Asphalt and Soil Stabilizer Bit (7/8" Shank)		117-3884		
Asphalt and Soil Stabilizer Bit - Carbide Face (7/8" Shank)		117-3885		
Soil Stabilizer Bit (7/8" Shank)		195-7244		
Concrete Bit (3/4" Shank)		149-5763	144-1236	
Enhanced Rotation Bit (3/4" Shank)		138-0678	144-1237	
Grooved Bit (3/4" Shank)		174-7984	174-7983	
Stabilizer Bit (1" Shank for use with 113-0313 Dual Holder)		113-0312		
Washer - Hardened		8C-1856		
<i>Specialty Tools</i>		<i>Part Number</i>		
Installation/Removal Tool		8T-4474		
Punch (For use with pneumatic tool)		104-8591		



GROUND ENGAGING TOOLS - RIPPER / SCARIFIER

Large Ripper / Scarifier Tips	326
Large Ripper / Scarifier Shanks	327
Small Ripper / Scarifier Tips	328
Small Ripper / Scarifier Shanks	329

Ground Engaging Tools - Ripper / Scarifier Tips

Large Rippers

For large rippers, there are two types of tips available — centerline and penetration. Both types of tips have a center rib for strength and sharpness, in addition to being forged from DH-3 steel for added strength and wear resistance. Available in several lengths to meet various applications.



Centerline Ripper Tips

- Offer good penetration and more wear material.



Penetration Ripper Tips

- Offer better initial penetration.
- Penetration tips should be installed with the rib up.



ARM Ripper Tips

- Offer increased wear life, and enhanced penetration and productivity.
- ARM Ripper Tips should not be used in severe impact conditions.

MODEL	CENTERLINE			ARM	PENETRATION			ARM
	LONG	MEDIUM	SHORT	CENTERLINE MEDIUM	LONG	MEDIUM	SHORT	PENETRATION MEDIUM
D8L, D8, D8N, D8R	114-0453	9W-2452	9W-2451	8E-5770		4T-5452	4T-5451	8E-5771
D9, D9N, D9R	114-0453	9W-2452	9W-2451	8E-5770		4T-5452	4T-5451	8E-5771
D9L, D9R SS*, D9R DR*	8E-8503	4T-4502	4T-4501	8E-5774	4T-5503	4T-5502	4T-5501	8E-5772
D10, D10N, D10R	8E-8503	4T-4502	4T-4501	8E-5774	4T-5503	4T-5502	4T-5501	8E-5772
D11 MS	8E-8503	4T-4502	4T-4501	8E-5774	4T-5503	4T-5502	4T-5501	8E-5772
D11 SS		9W-4552	9W-4551			6Y-3552		

* Applicable for serial numbers 8BL1000-UP and 7TL753-UP.

Ground Engaging Tools - Ripper / Scarifier Shanks

Shank Protectors and Pin / Retainers

MODEL	SHANK PROTECTOR			COUNTERBORED RIPPER SHANK				NON-COUNTERBORED PIN ASSY.
	STANDARD	SHARP	EXTENDED	NON-REUSABLE PIN	RET. ASSY.	REUSABLE PIN	RETAINER	
D8, D8N, D8R, D8L	6J-8814	8E-1848	132-4716			6Y-3394	8E-4743	4T-2479+ 6J-8814++
D9, D9N, D9R	6J-8814	8E-1848	132-4716			6Y-3394	8E-4743	4T-2479+ 6J-8814++
D9L, D9R SS*, D9R DR*		9W-8365		6Y-1204	6Y-1202	6Y-3909	4T-4707	102-9062
D10		6Y-8960		6Y-1204	6Y-1202	6Y-3909	4T-4707	102-9062
D10R MS, D10N, D10R		9W-8365		6Y-1204	6Y-1202	6Y-3909	4T-4707	102-9062
D10R SS		6Y-8960		6Y-1204	6Y-1202	6Y-3909	4T-4707	102-9062
D11 MS		6Y-8960		6Y-1204	6Y-1202	6Y-3909	4T-4707	102-9062
D11 SS		9N-4621		9N-4245	6Y-1205	8E-2229	8E-2230	6Y-2443

* Applicable for serial numbers 8BL1000-UP and 7TL753-UP.

+ Top protector hole.

++ Lower protector hole.

Shank Repair / Conversion Parts

MODEL	ADAPTER	NOSE
D8L, D8, D8N, D8R	8E-8418	9U-9694
D9, D9N, D9R	8E-8418	9U-9694
D9L (1 pin protector)	1U-3630	103-8114
D9L, D9R HD (2 pin protector)	103-8115	107-3361
D10 (1 pin protector)	1U-3630	103-8114
D10 (2 pin protector)	103-8115	107-3361
D11 MS (1 pin protector)	1U-3630	103-8114
D11 MS (2 pin protector)	103-8115	107-3361
D11 SS	104-9279	

Ground Engaging Tools - Ripper / Scarifier Tips

Small Rippers and Scarifiers

For small rippers and scarifiers, there are two types of tips available — centerline and penetration. Both types of tips have a center rib for strength and sharpness, in addition to being forged from DH-3 steel for added strength and wear resistance. Available in several lengths to meet various applications.



Centerline Ripper Tips

- Offer good penetration and more wear material.



Penetration Ripper Tips

- Offer better initial penetration.
- Penetration tips should be installed with the rib up.

MODEL	CENTERLINE	PENETRATION				
	LONG	LONG	SHORT	SHARP	PIN	RETAINER
D3	1U-3202*	1U-3209*		9W-8209	8E-6208	8E-6209
D4		6Y-0309		9W-7309	9W-2668	1U-2405
D5, D6, D7	6Y-0352	6Y-0359			8E-6358	1U-2405
931	1U-3202*	1U-3209*		9W-8209	8E-6208	8E-6209
943, 953		9J-4259*	1U-3251*	9W-8259	8E-6258	8E-6259
963		6Y-0309		9W-7309	9W-2668	1U-2405
973	6Y-0352	6Y-0359			8E-6358	1U-2405
12, 14		6Y-0309		9W-7309	9W-2668	1U-2405
16	6Y-0352	6Y-0359			8E-6358	1U-2405
V-Block (Rear Notched)	6Y-5230					
V-Block (Front Notched)	6Y-5230					
Straight Block (Rear Notched)	6Y-5230					
No. 6 (Non-current)	5K-0450*					

* DH-2 Steel.

Ground Engaging Tools - Ripper / Scarifier Shanks

Shanks

MODEL	RIPPER		SCARIFIER	
	CURVED	STRAIGHT	STANDARD	LONG
D4		8J-5299		
D4	9J-8913 6Y-0865**	9J-6586		
D6, D7	9J-8923	9J-3139		
931		9W-7382		
943		8J-5299		
953	1U-1257			
963	1U-1257			
963	9J-8913 6Y-0865**	9J-6586		
12	9J-8913 6Y-0865**	9J-6586		
14	9J-8913 6Y-0865**	9J-6586		
V-Block (Rear Notched)	9J-8923	9J-3139		
V-Block (Front Notched)			5B-0947	
Straight Block (Rear Notched)			9F-5124	7D-4501
No. 6 (Non-current)			5B-6251	
No. 6 (Non-current)			6K-5704	

** Heavy-Duty Shank — use 6Y-0352 or 6Y-0359 tips with a 9W-2678 pin and a 1U-2405 retainer.



GROUND ENGAGING TOOLS - SCRAPER

Cutting Edges	332
Router Bits	333
Integrated Tooth Cutting Edges	334
Integrated Tooth Cutting Edge Tips	334
Bolt-On Adapters	334
Bolt-On Adapter Tips	335

Ground Engaging Tools - Scraper Cutting Edges

Scraper Cutting Edges

There's a complete line of scraper cutting edges, providing the right combination of edge thickness and arrangement to match practically any job condition.

All edges are rolled from DH-2 steel and through-hardened for strength and wear resistance. Two types are available:

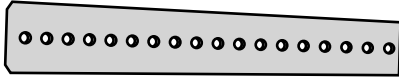

Level Cut Arrangement

- For finish work or very high impact conditions where stinger breakage is a problem.

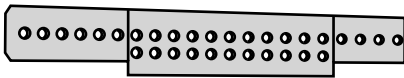

Stinger Arrangement

- The standard configuration of cutting edge on most scrapers. Provides good penetration and efficient flow of material into the bowl.

MODEL	THICKNESS		STINGER ARRANGEMENT		CHANGES FOR LEVEL CUT		BOLTS	NUTS
	(in)	(mm)	CENTER	ENDS	CENTER	ENDS		
613, 613C	0.88	22	4T-6611	4T-6613 (2)		b	4F-7827 (15)	2J-3506 (15)
615 (46Z1-1342, 47Z1-1339)	0.88	22	7T-5104	7T-5105 (2)		b	5J-2409 (13)	2J-3505 (13)
	0.88	22	9W-5807	9W-5810		9W-5806 (2)	4J-9058 (17)	2J-3507 (17)
621B, 621E, 621F, 627B, 627E, 627F	0.88	22	4T-6568	4T-6612 (2)	a		3J-2801 (14)	2J-3507 (14)
	1.12	28	4T-2896	4T-6380 (2)		4T-2894 (2)	3J-2801 (14)	2J-3507 (14)
623B, 623E, 623F, J619, J621	0.88	22	4T-2887	4T-6612 (2)	4T-6620		4F-4042 (20)	2J-3507 (20)
	1.12	28	4T-2895	4T-6380 (2)	a		4F-4042 (20)	2J-3507 (20)
631D, 631E, 637D, 637E	0.88	22	4T-6566	4T-6614 (2)	a		4F-4042 (16)	2J-3507 (16)
	1.12	28	4T-3444	4T-6378 (2)	a		4F-4042 (16)	2J-3507 (16)
	1.38	35	9J-4369	9W-6092 (2)		7J-0225 (2)	4F-4042 (16)	2J-3507 (16)
	1.62	41	9J-5899	7J-2959 (2)	a		4F-4042 (16)	2J-3507 (16)
633D, 639	1.12	28	4T-3428	4T-2899 (2)	a		4F-4042 (17)	2J-3507 (17)
	1.38	35	9J-1111	9J-1109 (2)	a		4F-4042 (17)	2J-3507 (17)
651B, 657B	1.38	35	7J-1551	7J-0225 (2)	7J-0226		4J-9058 (34)	2J-3507 (17)
	1.62	41	7J-2977	7J-2978 (2)	7J-2981		4J-9058 (34)	2J-3507 (17)
651E (88Z146-UP)	1.38	35	9W-4901	9W-4902	a		4J-9058 (48)	2J-3507 (48)
	1.38	35	9W-4505	9W-4399 (2)	a		6V-6535 (29)*	3K-9770 (29)
	1.62	41	9W-4394	9W-4509 (2)	a		6V-6535 (29)*	3K-9770 (29)
	1.75	45	9W-9701	9W-9702	a		4J-9058 (48)	2J-3507 (48)
651F, 657F	1.38	35	9W-4901	9W-4902	a		4J-9058 (48)	2J-3507 (48)
	1.75	45	9W-9701	9W-9702	a		4J-9058 (48)	2J-3507 (48)
657E (86Z241-UP, 6MB91-UP)	1.38	35	9W-4901	9W-4902	a		4J-9058 (48)	2J-3507 (48)
	1.38	35	9W-4505	9W-4399 (2)	a		6V-6535 (29)*	3K-9770 (29)
	1.62	41	9W-4394	9W-4509 (2)	a		6V-6535 (29)*	3K-9770 (29)
	1.75	45	9W-9701	9W-9702	a		4J-9058 (48)	2J-3507 (48)

a - Reposition center section.

b - Reposition end sections.

* Requires 4K-0684.

Ground Engaging Tools - Scraper Router Bits

Router Bits

Router Bits are used on all scrapers to protect the lower corners of the bowl. They are made of DH-2 steel and through-hardened for extra strength and wear resistance. Three types are available:

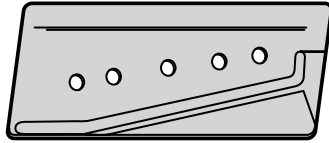

Standard Router Bits

- Recommended for most applications. Reversible for added life and value.

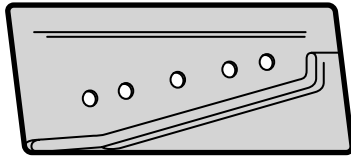

Heavy Duty Router Bits

- Have 45% more wear material than standard router bits and are reversible. To avoid possible damage to the bowl, they should not be used in high impact conditions.

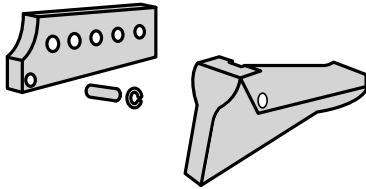

Quick Change Router Bits

- Designed to reduce downtime in abrasive conditions. Pinned onto supports which bolt to the bowl.

MODEL	STD.	HEAVY DUTY	QUICK-CHANGE				BOLTS	NUTS	WASHERS
			SUPPORT	BIT	PIN	RETAIN.			
613, 613B	9F-1831*						a	4K-0367 (3)	
613C	4T-4336	9W-4903**					8S-9092 (3)	4K-0367 (3)	5P-8247 (3)
615, 621, 623, 627	4J-8665						1D-4637 (5)	2J-3507 (5)	5P-8250 (5)
631, 633, 637	4J-8665	7J-3023++	4T-0051	4T-0054	4T-0055	1U-2405	4F-4042 (5)	2J-3507 (5)	5P-8250 (5)
639, 651B, 657B	4J-8665	7J-3023++	4T-0051	4T-0054	4T-0055	1U-2405	4F-4042 (5)	2J-3507 (5)	5P-8250 (5)
651E (88Z146-UP)		7J-3023	4T-0051	4T-0054	4T-0055	1U-2405	4J-9058 (5)	2J-3507 (5)	5P-8250 (5)
651E (88Z1-145)	4T-0668		4T-1512	4T-1514	8E-6358	8E-6359	5P-8823 (5)+	3K-9770 (5)	4K-0684 (5)
651F, 657F		7J-3023	4T-0051	4T-0054	4T-0055	1U-2405	4J-9058 (5)	2J-3507 (5)	5P-8250 (5)
657E (86Z241-UP, 6MB91-UP)		7J-3023	4T-0051	4T-0054	4T-0055	1U-2405	4J-9058 (5)	2J-3507 (5)	5P-8250 (5)
657E (86Z1-240, 6MB1-90)	4T-0668		4T-1512	4T-1514	8E-6358	8E-6359	5P-8823 (5)+	3K-9770 (5)	4K-0684 (5)

a - 613 and 613B require one 1B-4367 bolt and two 8S-9092 bolts per router bit.

* 9J-4414 (LH) and 9J-4413 (RH) end bits are also available for finishing and cleaning operations.

** Clean up or two position router bit.

+ Uses 6V-6535 bolts rather than 5P-8823 with quick-change.

++ Uses 4J-9058 bolts.

Ground Engaging Tools - Scraper Cutting Edges and Tips

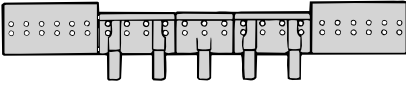

Integrated Tooth Cutting Edges

- Improve penetration in compacted soils.
- Consist of three center edge sections with cast-in adapters and two standard end sections.
- Replaceable tips provide low operating costs in abrasive conditions.

MODEL	CENTER TOOTH EDGE	END TOOTH EDGE	CUTTING EDGE ENDS	BOLTS	NUTS
623	1U-1901 (1)	1U-1902 (2)	4T-6612 (2)	3J-2801 (10)* 4F-4042 (20)	2J-3507 (30)
633, 639	9J-1108 (1)	9J-1107 (2)	9J-1109 (2)**	4F-4042 (34)	2J-3507 (34)

* For use on 4T-6612 Cutting Edge (5 per end).

** Applicable for serial number 19W only. For serial number 86H, use 8J-3137 (2) cutting edge ends.

Integrated Tooth Cutting Edge Tips

MODEL	NUMBER OF TEETH	SHORT	LONG	PENETRATION	WIDE	SHARP	HEAVY DUTY LONG	HEAVY DUTY ABRASION	PIN	RETAINER ASSEMBLY
623	5	1U-3301	1U-3302	9J-4309	107-3300	9W-8309	9N-4302	9N-4303	107-3308	8E-6259
633, 639	5	1U-3351	1U-3352	9J-4359	107-3350	9W-2359	9N-4352	9N-4353	8E-6358	8E-6359

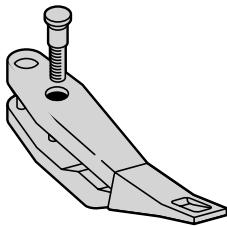

Bolt-On Adapters

- Improve penetration in compacted soils.
- Provide an easily replaceable tooth option for machines that change applications frequently and may not need teeth on all jobs.
- Install over the center section in the stinger configuration.

MODEL	ADAPTER	BOLTS	NUTS	WASHERS
613	9J-8455	5F-8933 (2)	2J-3506 (2)	
615 (47Z1-1339)	4T-5805	1J-0849 (2)	2J-3505 (2)	
615 (47Z1340-UP)	9J-2307	1J-3527 (2)	2J-3507 (2)	5P-8250 (2)
J619, J621, 623, 633, 639	9W-9971*	1J-4947 (2)	2J-3507 (2)	5P-8250 (2)

* Recommended for use only with 9W-9972 notched center edge. Use 8J-3137 end edges with 86H models. Use 9J-1109 end edges with 19W models.

Ground Engaging Tools - Scraper Bolt-on Adapter Tips

Bolt-On Adapter Tips

MODEL	NUMBER OF TEETH	SHORT	LONG	PENETRATION	WIDE	SHARP	HEAVY DUTY LONG	HEAVY DUTY ABRASION	PIN	RETAINER ASSEMBLY
613	4	1U-3251	1U-3252	9J-4259	107-3300	9W-8309	9N-4252	9N-4253	8E-6258	8E-6259
615 (47Z1-1339)	5	1U-3301	1U-3302	9J-4309	107-3300	9W-8309	9N-4302	9N-4303	107-3308	8E-6259
615 (47Z1340-UP)	4	1U-3301	1U-3302	9J-4309	107-3300	9W-8309	9N-4302	9N-4303	107-3308	8E-6259
J619, J621, 623, 633, 639	5	1U-3351	1U-3352	9J-4359	107-3350	9W-2359	9N-4352	9N-4353	8E-6358	8E-6359

ARM Cutting Edges

In addition to our standard cutting edges, your dealer now has a full line of ARM Cutting Edges for Scrapers. These include ARM Center C/E, ARM End Edge, ARM Router Bits, and ARM Serrated Center C/E.

HARDWARE

Bolts	338
Nuts	370
Washers	378
Screws	382
Studs	384
Eyebolts	385
Rivets	386
Pins	389
Rod Ends	392
Woodruff Keys	395
Snap Rings	396
Hose Clamps	398
Springs	399
Kits	402



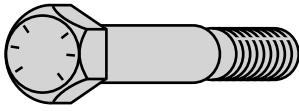

Hex Head Bolts

- Designed with smooth rolled threads for better clamp load, shear resistance and resistance to stripping.
- Made of fine grain steel for a more uniform micro-structure, resulting in improved toughness and fracture resistance.
- Inch Bolts
 - Meet or exceed SAE Grade 8 specifications for tensile strength and proof load, minimum tensile strength of 150,000 psi.
 - Have 20% higher head height than SAE specifications for longer wear life, easier gripping and less slippage.
 - Marked with 6 radial dashes on the bolt head.
- Metric Bolts
 - Meet or exceed ISO Class 10.9 specifications for tensile strength and proof load, minimum tensile strength of 150,000 psi.
 - Marked with 10.9 on the bolt head.
- Bolt Coatings
 - Phosphate and Oil coating provides better clamp loads and torque retention.
 - Zinc Dichromate plating provides better long term corrosion resistance.

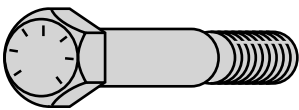

High Strength Hex Head Bolts

- Thread design and steel - similar to HEX Head Bolts.
- Inch Bolts
 - Have 20% higher head height than SAE specifications for longer wear life, easier gripping and less slippage.
 - Exceed SAE Grade 8 specifications for tensile strength and proof load, minimum tensile strength of 170,000 psi.
 - Marked with seven radial dashes on the bolt head.
- Metric Bolts
 - Exceed ISO 10.9 specifications for tensile strength and proof load, minimum tensile strength of 170,000 psi.
 - Marked with 11.9 on the bolt head.
- Coatings - similar to HEX Head Bolts.



Bolts

12 Point Head Bolts

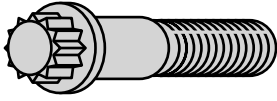

- Designed with smooth rolled threads for better clamp load, shear resistance, and resistance to stripping.
- Made of fine grain steel for a more uniform micro-structure, resulting in improved toughness and fracture resistance.
- Exceed SAE Grade 8 specifications for tensile strength and proof load, minimum tensile strength of 170,000 psi.
- For use in restricted clearance applications.

Hex Socket Head Screw Bolts

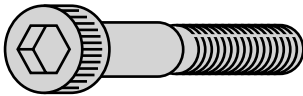

- Designed with smooth rolled threads for better clamp load, shear resistance, and resistance to stripping.
- Made of fine grain steel for a more uniform micro-structure, resulting in improved toughness and fracture resistance.
- Exceed SAE Grade 8 specifications for tensile strength and proof load, minimum tensile strength of 170,000 psi.
- For use in restricted clearance applications.

Hex Head Forcing Bolts

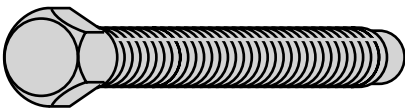

- Designed with smooth rolled threads for better clamp load, shear resistance, and strip resistance.
- Made of fine grain steel for a more uniform micro-structure, resulting in improved toughness and fracture resistance.



Hardware

Bolts

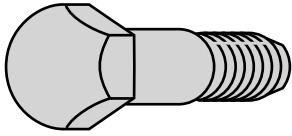

Track Bolts and Split Master Link Bolts

- High dome Hex head for longer wear life and reuseability.
- Exceed SAE Grade 8 specifications for tensile strength and proof load, minimum tensile strength 170,000 psi.
- Special induction heat treat process provides Rockwell C37-42 hardness.

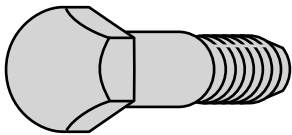

High Strength Track Bolts

- Similar high dome Hex head as standard Track Bolts.
- Exceed SAE Grade 8 specifications for tensile strength and proof load, minimum tensile strength 180,000 psi.
- Special induction heat treat process provides Rockwell C39 - 43 hardness.

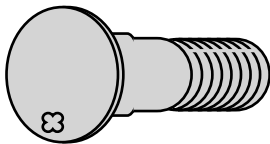

Cutting Edge Bolts

- Dome shaped head for added strength and wear resistance.
- Exceed SAE Grade 8 specifications for tensile strength and proof load, minimum tensile strength of 150,000 psi.
- Special induction heat treat process provides Rockwell C33 - 39 minimum.

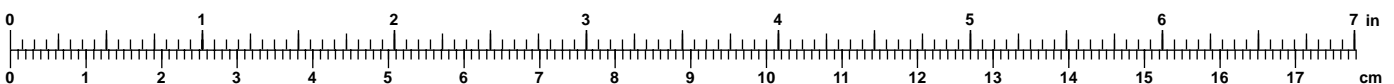

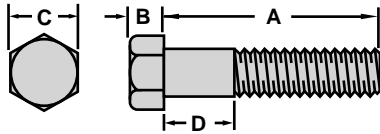

Hex Head Bolts / Inch / Coarse Thread UNC / Phosphate & Oil Coated

THREAD SIZE (in - TPI)	A BOLT LENGTH (in)	B HEAD HEIGHT (in)	C HEAD WIDTH (in)	D GRIP LENGTH (in)	PART NUMBER
1/4-20	3/8	0.19	0.44	0.06	0S-1613
	1/2	0.19	0.44	0.06	0S-1614
	5/8	0.19	0.44	0.13	2A-0762
	3/4	0.19	0.44	0.13	0S-1615
	7/8	0.19	0.44	0.13	4F-7957
	1	0.19	0.44	0.13	0S-1616
	1 1/8	0.19	0.44	0.37	9F-6580
	1 1/4	0.19	0.44	0.13	7B-2742
	1 3/8	0.19	0.44	0.63	2A-5546
	1 1/2	0.19	0.44	0.25	9F-7022
	1 5/8	0.19	0.44	0.87	7B-8167
	1 3/4	0.19	0.44	1.00	1B-2713
	2	0.19	0.44	1.13	8B-2377
	2 1/4	0.19	0.44	1.37	1D-4533
	2 1/2	0.19	0.44	1.75	1B-2714
	2 3/4	0.19	0.44	2.00	2A-4781
	3	0.19	0.44	2.00	4B-9365
	3 1/4	0.19	0.44	2.50	8F-8178
	3 1/2	0.19	0.44	2.75	3B-8695
	3 3/4	0.19	0.44	3.00	8F-6302
	4	0.19	0.44	3.25	8S-4710
	4 1/2	0.19	0.44	3.75	8S-4711
	4 3/4	0.19	0.44	4.00	4L-3776
	5	0.19	0.44	4.25	1B-2716
5 1/2	0.19	0.44	4.50	1B-2717	
6	0.19	0.44	5.25	1B-2718	
6 1/2	0.19	0.44	5.50	4N-1761	
Nut				9S-8750	
Washer				5P-0537	
5/16-18	1/2	0.24	0.50	0.06	1C-0569
	5/8	0.24	0.50	0.13	2H-3755
	3/4	0.24	0.50	0.13	0S-1617
	7/8	0.24	0.50	0.13	2B-2695
	1	0.24	0.50	0.13	0S-1618
	1 1/8	0.24	0.50	0.25	4B-3388
	1 1/4	0.24	0.50	0.37	1B-7182
	1 3/8	0.24	0.50	0.50	1B-2790
	1 1/2	0.24	0.50	0.09	1A-9579

THREAD SIZE (in - TPI)	A BOLT LENGTH (in)	B HEAD HEIGHT (in)	C HEAD WIDTH (in)	D GRIP LENGTH (in)	PART NUMBER
5/16-18	1 5/8	0.24	0.50	0.75	1H-5514
	1 3/4	0.24	0.50	0.87	1B-9575
	2	0.24	0.50	1.13	2B-2694
	2 1/4	0.24	0.50	1.37	1D-4538
	2 1/2	0.24	0.50	1.63	1D-4539
	2 3/4	0.24	0.50	1.87	1D-4540
	3	0.24	0.50	2.13	1D-4541
	3 1/4	0.24	0.50	2.25	1F-5842
	3 1/2	0.24	0.50	2.63	1F-4111
	3 3/4	0.24	0.50	2.75	4B-0831
	4	0.24	0.50	3.00	4B-3903
	4 1/4	0.24	0.50	3.37	8H-8769
	4 1/2	0.24	0.50	3.63	3H-5932
	4 3/4	0.24	0.50	3.87	3H-3243
	5	0.24	0.50	4.13	1F-6296
	5 1/2	0.24	0.50	4.63	5L-1761
	5 3/4	0.24	0.50	4.87	8M-1865
	6	0.24	0.50	5.13	5P-0059
	6 1/2	0.24	0.50	5.37	4F-3508
	Nut				5S-0003
Washer				9M-1974	
3/8-16	1/2	0.29	0.56	0.09	4F-4879
	5/8	0.29	0.56	0.09	0T-0102
	3/4	0.29	0.56	0.13	0S-0509
	7/8	0.29	0.56	0.13	0L-1351
	1	0.29	0.56	0.13	0S-1594
	1 1/8	0.29	0.56	0.31	1A-2029
	1 1/4	0.29	0.56	0.25	0S-1588
	1 3/8	0.29	0.56	0.37	3B-1915
	1 1/2	0.29	0.56	0.37	0S-1591
	1 5/8	0.29	0.56	0.87	2A-4639
	1 3/4	0.29	0.56	0.75	0S-1571
	1 7/8	0.29	0.56	1.06	1C-2251
	2	0.29	0.56	1.00	0S-1590
	2 1/4	0.29	0.56	1.25	0L-2070
	2 1/2	0.29	0.56	1.50	0L-1143
2 3/4	0.29	0.56	1.75	0T-0573	
3	0.29	0.56	2.00	0S-1619	

* High strength bolt.

Hardware

Hex Head Bolts / Inch / Coarse Thread UNC / Phosphate & Oil Coated

THREAD SIZE (in - TPI)	A BOLT LENGTH (in)	B HEAD HEIGHT (in)	C HEAD WIDTH (in)	D GRIP LENGTH (in)	PART NUMBER
3/8-16	3 1/4	0.29	0.56	2.25	0L-1352
	3 1/2	0.29	0.56	2.50	0T-0065
	3 3/4	0.29	0.56	2.50	0S-1608
	4	0.29	0.56	3.00	8S-9191
	4 1/4	0.29	0.56	3.25	0T-0055
	4 1/2	0.29	0.56	3.25	1A-5964
	4 3/4	0.29	0.56	3.75	1A-5183
	5	0.29	0.56	4.00	5B-9603
	5 1/4	0.29	0.56	4.25	5B-2638
	5 1/2	0.29	0.56	4.50	5F-4899
	5 3/4	0.29	0.56	4.75	7F-3425
	6	0.29	0.56	4.87	1D-4706
	6 1/4	0.29	0.56	4.75	8F-8544
	6 1/2	0.29	0.56	5.25	4F-0411
	7	0.29	0.56	5.75	9F-8999
	7 1/2	0.29	0.56	6.25	6B-1557
	8	0.29	0.56	6.75	8F-6350
	8 1/2	0.29	0.56	7.25	9F-2773
	9	0.29	0.56	7.75	5F-6044
	9 1/2	0.29	0.56	8.25	4H-3283
	11	0.29	0.56	9.75	5P-1415
12	0.29	0.56	11.00	7M-1202	
Nut					9S-8752
Washer					5M-2894
7/16-14	3/4	0.34	0.69	0.19	5P-0060
	7/8	0.34	0.69	0.13	3L-0526
	1	0.34	0.69	0.13	0T-0318
	1 1/8	0.34	0.69	0.13	4F-8965
	1 1/4	0.34	0.69	0.13	0T-0320
	1 3/8	0.34	0.69	0.25	3H-5368
	1 1/2	0.34	0.69	0.37	0T-0772
	1 3/4	0.34	0.69	0.63	0T-0768
	2	0.34	0.69	0.87	0T-0319
	2 1/4	0.34	0.69	1.13	1D-4707
	2 1/2	0.34	0.69	1.37	1D-4703
	2 3/4	0.34	0.69	1.63	1D-4556
	3	0.34	0.69	1.87	4F-5192
	3 1/4	0.34	0.69	2.13	3B-8428
	3 1/2	0.34	0.69	2.37	7F-8698
	3 3/4	0.34	0.69	2.63	9F-2491
	4	0.34	0.69	2.87	4F-7226

THREAD SIZE (in - TPI)	A BOLT LENGTH (in)	B HEAD HEIGHT (in)	C HEAD WIDTH (in)	D GRIP LENGTH (in)	PART NUMBER	
7/16-14	4 1/4	0.34	0.69	3.13	2J-5907	
	4 1/2	0.34	0.69	3.25	4B-7220	
	4 3/4	0.34	0.69	3.63	7H-3472	
	5	0.34	0.69	3.75	5B-5059	
	5 1/2	0.34	0.69	4.37	8F-4197	
	6	0.34	0.69	4.87	8F-6419	
	6 1/2	0.34	0.69	5.13	3L-0742	
	7	0.34	0.69	5.63	7H-7209	
	7 1/2	0.34	0.69	6.13	2L-7442	
	8	0.34	0.69	6.62	4L-7925	
	9	0.34	0.69	7.63	4L-7926	
	11	0.34	0.69	9.63	3L-4317	
	Nut					3S-1546
	Washer					5P-8244
	1/2-13	1/2	0.39	0.75	0.06	1K-6705
		3/4	0.39	0.75	0.13	0S-1620
7/8		0.39	0.75	0.28	2H-3855	
1		0.39	0.75	0.13	0S-1621	
1 1/8		0.39	0.75	0.13	6H-1717	
1 1/4		0.39	0.75	0.31	0S-1595	
1 3/8		0.39	0.75	0.44	7B-3235	
1 1/2		0.39	0.75	0.25	0S-1585	
1 3/4		0.39	0.75	0.44	0S-1587	
2		0.39	0.75	0.75	1A-1460	
2 1/4		0.39	0.75	1.00	9X-8873	
2 1/4		0.39	0.75	1.00	2B-0947*	
2 1/2		0.39	0.75	1.25	9S-1366	
2 3/4		0.39	0.75	1.50	1A-5822	
3		0.39	0.75	1.75	9X-8874	
3		0.39	0.75	1.75	0L-1329*	
3 1/4		0.39	0.75	2.00	0V-0375	
3 1/2		0.39	0.75	2.25	9X-8875	
3 1/2		0.39	0.75	2.25	1D-4566*	
3 3/4		0.39	0.75	2.50	1B-2886	
4		0.39	0.75	2.75	0S-1573	
4 1/4	0.39	0.75	3.00	1D-4569		
4 1/2	0.39	0.75	3.25	8S-9089		
4 3/4	0.39	0.75	3.50	9X-8876		
4 3/4	0.39	0.75	3.50	2B-2006*		
5	0.39	0.75	3.75	9X-8877		
5	0.39	0.75	3.75	2H-6488*		

* High strength bolt.

Hex Head Bolts / Inch / Coarse Thread UNC / Phosphate & Oil Coated

THREAD SIZE (in - TPI)	A BOLT LENGTH (in)	B HEAD HEIGHT (in)	C HEAD WIDTH (in)	D GRIP LENGTH (in)	PART NUMBER	
1/2-13	5 1/4	0.39	0.75	4.00	9X-8878	
	5 1/4	0.39	0.75	4.00	6F-5282*	
	5 1/2	0.39	0.75	4.25	9X-8879	
	5 1/2	0.39	0.75	4.25	1D-4572*	
	5 3/4	0.39	0.75	4.50	8F-8804	
	6	0.39	0.75	4.75	1D-4574	
	6 1/4	0.39	0.75	4.75	9H-8260	
	6 1/2	0.39	0.75	5.00	2A-1531	
	7	0.39	0.75	5.50	1A-7669	
	7 1/2	0.39	0.75	6.00	1A-0168	
	8	0.39	0.75	6.50	9S-1374	
	8 1/2	0.39	0.75	7.00	1B-3573	
	9	0.39	0.75	7.50	6M-9613	
	10	0.39	0.75	8.50	6F-5281	
	10 1/2	0.39	0.75	9.00	8M-0139*	
	11	0.39	0.75	9.50	8S-3887	
	11 1/2	0.39	0.75	10.00	5P-5421*	
	13	0.39	0.75	11.50	8S-6212*	
	14	0.39	0.75	12.50	5M-7900*	
		Nut				1F-7958
	Washer				5P-8245	
9/16-12	1	0.43	0.87	0.12	3K-3379	
	1 1/4	0.43	0.87	0.16	8S-4732	
	1 3/8	0.43	0.87	0.17	4B-8519	
	1 1/2	0.43	0.87	0.16	8S-4733	
	2 1/2	0.43	0.87	1.13	8S-4735	
	3	0.43	0.87	1.63	8S-4736	
	3 1/2	0.43	0.87	2.13	8S-4737	
	4	0.43	0.87	2.63	8S-4738	
	4 1/2	0.43	0.87	3.13	8S-4739	
	5	0.43	0.87	3.63	8S-4740	
	5 1/2	0.43	0.87	4.13	8S-4741	
	6	0.43	0.87	4.63	8S-4742	
	8	0.43	0.87	6.38	9H-9129	
		Nut				5P-0539
		Washer				5P-8246
	5/8-11	3/4	0.48	0.94	0.06	1H-9456
1		0.48	0.94	0.19	0S-1624	
1 1/8		0.48	0.94	0.28	7S-9372	
1 1/4		0.48	0.94	0.19	0S-1592	
1 3/8		0.48	0.94	0.19	4B-4043	

THREAD SIZE (in - TPI)	A BOLT LENGTH (in)	B HEAD HEIGHT (in)	C HEAD WIDTH (in)	D GRIP LENGTH (in)	PART NUMBER
5/8-11	1 1/2	0.48	0.94	0.19	0S-1566
	1 3/4	0.48	0.94	0.25	0S-1589
	2	0.48	0.94	0.50	9X-8880
	2	0.48	0.94	0.50	1A-1135*
	2 1/4	0.48	0.94	0.75	9X-8881
	2 1/4	0.48	0.94	0.75	8S-9092*
	2 1/2	0.48	0.94	0.63	9X-8882
	2 1/2	0.48	0.94	0.63	0S-1625*
	2 3/4	0.48	0.94	1.25	9X-8883
	2 3/4	0.48	0.94	1.25	1A-8537*
	3	0.48	0.94	1.50	1B-4367
	3 1/4	0.48	0.94	1.75	1D-4585
	3 1/2	0.48	0.94	2.00	1D-4586
	3 3/4	0.48	0.94	2.25	0L-1169
	4	0.48	0.94	2.50	0S-1569
	4 1/4	0.48	0.94	2.75	1D-4588
	4 1/2	0.48	0.94	3.00	1A-8651
	4 3/4	0.48	0.94	3.25	1D-4590
	5	0.48	0.94	3.50	1A-5405
	5 1/4	0.48	0.94	3.75	9X-8884
	5 1/4	0.48	0.94	3.75	7S-3224*
	5 1/2	0.48	0.94	4.00	1D-4593
	6	0.48	0.94	4.50	1D-4595
	6 1/4	0.48	0.94	4.50	5D-9514
	6 1/2	0.48	0.94	4.75	1D-4597
	7	0.48	0.94	5.25	1D-4599
	7 1/2	0.48	0.94	5.75	1D-4600
	8	0.48	0.94	6.25	1B-7709
	8 1/2	0.48	0.94	6.75	1D-4601
	9	0.48	0.94	7.25	2H-3756
9 1/2	0.48	0.94	7.75	1D-4602	
11 1/2	0.48	0.94	9.75	5P-4624	
	Nut				4K-0367
	Washer				5P-8247
3/4-10	1	0.58	1.13	0.31	7H-2069
	1 1/4	0.58	1.13	0.31	0S-1583
	1 1/2	0.58	1.13	0.31	0S-1626
	1 3/4	0.58	1.13	0.31	1A-0458
	2	0.58	1.13	0.31	0L-1178
	2 1/4	0.58	1.13	0.50	9X-8885
2 1/4	0.58	1.13	0.50	2A-1538*	

* High strength bolt.

Hardware

Hex Head Bolts / Inch / Coarse Thread UNC / Phosphate & Oil Coated

THREAD SIZE (in - TPI)	A BOLT LENGTH (in)	B HEAD HEIGHT (in)	C HEAD WIDTH (in)	D GRIP LENGTH (in)	PART NUMBER
3/4-10	2 1/2	0.58	1.13	0.75	1A-8063
	2 3/4	0.58	1.13	1.00	9X-8886
	2 3/4	0.58	1.13	1.00	1D-4608*
	3	0.58	1.13	1.25	9X-8887
	3	0.58	1.13	1.25	1D-4609*
	3 1/4	0.58	1.13	1.50	9X-8888
	3 1/4	0.58	1.13	1.50	1D-4610*
	3 1/2	0.58	1.13	1.75	9X-8889
	3 1/2	0.58	1.13	1.75	3B-2968*
	3 3/4	0.58	1.13	2.00	7F-5227
	4	0.58	1.13	2.25	1D-4612
	4 1/4	0.58	1.13	2.50	0S-1756
	4 1/2	0.58	1.13	2.75	0S-1627
	4 3/4	0.58	1.13	3.00	3B-6753
	5	0.58	1.13	3.25	1D-4614
	5 1/4	0.58	1.13	3.50	6V-8199
	5 1/2	0.58	1.13	3.75	1D-4615
	5 3/4	0.58	1.13	4.00	6K-1330
	6	0.58	1.13	4.25	1D-4616
	6 1/4	0.58	1.13	4.25	1D-4617
	6 1/2	0.58	1.13	4.50	2B-1015
	7	0.58	1.13	5.00	1D-4620
	7 1/2	0.58	1.13	5.50	1D-4621
	8	0.58	1.13	6.00	1D-4622
	8 1/2	0.58	1.13	6.50	1D-4623
	9	0.58	1.13	7.00	1D-4624
	9 1/2	0.58	1.13	7.50	5J-1702
	10	0.58	1.13	8.00	8F-4225
	11 1/2	0.58	1.13	9.50	4J-7945
	13	0.58	1.13	11.00	031-9099
Nut				2J-3506	
Washer				5P-8248	
7/8-9	1 1/2	0.67	1.31	0.25	0T-0690
	1 3/4	0.67	1.31	0.37	2H-3757
	2	0.67	1.31	0.37	9X-8890
	2	0.67	1.31	0.37	0S-1973*
	2 1/4	0.67	1.31	0.37	9F-9522
	2 1/2	0.67	1.31	0.50	1D-4625
	2 3/4	0.67	1.31	0.75	9X-8891
	2 3/4	0.67	1.31	0.75	1D-4626*
	3	0.67	1.31	1.00	1D-4627
	3 1/4	0.67	1.31	1.25	9X-8892

THREAD SIZE (in - TPI)	A BOLT LENGTH (in)	B HEAD HEIGHT (in)	C HEAD WIDTH (in)	D GRIP LENGTH (in)	PART NUMBER	
7/8-9	3 1/4	0.67	1.31	1.25	1D-4628*	
	3 1/2	0.67	1.31	1.50	9X-8893	
	3 1/2	0.67	1.31	1.50	1D-4629*	
	3 3/4	0.67	1.31	1.75	9X-8894	
	3 3/4	0.67	1.31	1.75	2H-3856*	
	4	0.67	1.31	2.00	9X-8895	
	4	0.67	1.31	2.00	1D-4630*	
	4 1/4	0.67	1.31	2.25	1D-4631	
	4 1/2	0.67	1.31	2.50	1A-5576	
	4 3/4	0.67	1.31	2.75	4J-8622	
	5	0.67	1.31	3.00	9S-1351	
	5 1/2	0.67	1.31	3.50	1D-4634	
	6	0.67	1.31	3.75	9S-1322	
	6 1/2	0.67	1.31	4.25	6J-1536	
	7	0.67	1.31	4.75	1D-5976	
	7 1/2	0.67	1.31	5.25	1K-9422	
	8	0.67	1.31	5.75	1D-6259	
	8 1/2	0.67	1.31	6.25	3K-7127	
	9	0.67	1.31	6.75	6K-8739	
	9 1/2	0.67	1.31	7.25	1D-6260	
	10	0.67	1.31	7.75	2B-2391	
	11	0.67	1.31	8.75	3K-3112	
	12 1/2	0.67	1.31	10.25	4D-8317	
	14	0.67	1.31	11.75	3K-0581	
	15	0.67	1.31	12.75	3K-3183	
	16	0.67	1.31	13.75	3K-6552	
	Nut				2J-3505	
	Washer				5P-8249	
	1-8	1 1/4	0.71	1.50	0.31	8S-4767
		1 1/2	0.71	1.50	0.31	0V-0450
1 3/4		0.71	1.50	0.37	1J-7370	
2		0.71	1.50	0.75	1J-5257	
2 1/4		0.71	1.50	0.25	8S-9093	
2 1/2		0.71	1.50	0.50	1D-4635	
2 3/4		0.71	1.50	0.50	9S-1363	
3		0.71	1.50	0.75	1D-4709	
3 1/4		0.71	1.50	1.00	1D-4637	
3 1/2		0.71	1.50	1.25	1D-4638	
3 3/4		0.71	1.50	1.50	8H-5772	
4		0.71	1.50	1.75	9X-8896	
4		0.71	1.50	1.75	1D-4639*	
4 1/4		0.71	1.50	2.00	9X-8897	

* High strength bolt.

Hex Head Bolts / Inch / Coarse Thread UNC / Phosphate & Oil Coated

THREAD SIZE (in - TPI)	A BOLT LENGTH (in)	B HEAD HEIGHT (in)	C HEAD WIDTH (in)	D GRIP LENGTH (in)	PART NUMBER	
1-8	4 1/4	0.71	1.50	2.00	1D-4640*	
	4 1/2	0.71	1.50	2.25	1D-4641	
	4 3/4	0.71	1.50	2.50	2A-1420	
	5	0.71	1.50	2.75	9X-8898	
	5	0.71	1.50	2.75	1D-4642*	
	5 1/2	0.71	1.50	3.25	1D-4643	
	6	0.71	1.50	3.75	9F-6936	
	6 1/2	0.71	1.50	4.00	5B-5473	
	7	0.71	1.50	4.50	5F-9338	
	7 1/2	0.71	1.50	5.00	2B-7218	
	8	0.71	1.50	5.50	1D-4644	
	8 1/2	0.71	1.50	6.00	1D-4645	
	9	0.71	1.50	6.50	1D-4646	
	9 1/2	0.71	1.50	7.00	1D-4647	
	10	0.71	1.50	7.50	2J-8348	
	10 1/2	0.71	1.50	8.00	8F-6453	
	11	0.71	1.50	8.50	8K-5130	
	11 1/2	0.71	1.50	9.00	7K-4363	
	12	0.71	1.50	10.50	2H-4010	
	13	0.71	1.50	10.50	6J-4081	
14	0.71	1.50	10.50	6M-2001		
15	0.71	1.50	13.50	2H-4011		
16	0.71	1.50	14.00	6M-1029		
	Nut				2J-3507	
	Washer				5P-8250	
1 1/8-7	2	0.72	1.69	0.25	3J-8281	
	2 1/2	0.72	1.69	1.00	7J-7222	
	2 3/4	0.72	1.69	0.44	2K-2037	
	3	0.72	1.69	0.50	1J-2814	
	3 1/2	0.72	1.69	1.00	1J-2175	
	4	0.72	1.69	0.63	3N-1614	
	4 1/4	0.72	1.69	1.75	5J-1572	
	4 1/2	0.72	1.69	2.00	5M-0544	
	5 1/4	0.72	1.69	3.00	6J-1551	
	6	0.72	1.69	3.50	8H-5727	
	6 1/2	0.72	1.69	3.75	8F-4486	
		Nut				4J-5977
		Washer				3S-1349
	1 1/4-7	2 1/2	0.81	1.87	0.44	3F-6353
		3	0.81	1.87	0.44	3R-2299
3 1/4		0.81	1.87	0.50	1J-5484	

THREAD SIZE (in - TPI)	A BOLT LENGTH (in)	B HEAD HEIGHT (in)	C HEAD WIDTH (in)	D GRIP LENGTH (in)	PART NUMBER
1 1/4-7	3 1/2	0.81	1.87	0.75	2B-1955
	4	0.81	1.87	1.25	2H-3758
	4 1/4	0.81	1.87	1.50	1S-6560
	4 1/2	0.81	1.87	1.75	3R-2300
	4 3/4	0.81	1.87	2.00	8F-1156
	5	0.81	1.87	2.25	2H-1618
	5 1/2	0.81	1.87	2.75	1B-2721
	6	0.81	1.87	3.25	2H-1537
	6 1/2	0.81	1.87	3.50	6H-1628
	7	0.81	1.87	4.00	6V-2624
	8	0.81	1.87	5.00	3F-9025
	8 1/2	0.81	1.87	5.50	1J-6775
	9	0.81	1.87	6.00	1K-9418
	9 1/2	0.81	1.87	6.50	1K-9420
	10	0.81	1.87	7.00	1D-4649
	10 1/2	0.81	1.87	7.50	6B-0388
	11	0.81	1.87	8.25	1K-9415
	13	0.81	1.87	10.50	1K-4378
	14	0.81	1.87	11.00	6V-1734
	15	0.81	1.87	12.00	031-0213
	Nut				3K-9770
	Washer				4K-0684
1 1/2-6	3 1/2	0.97	2.25	0.40	3J-1805
	4	0.97	2.25	0.50	6V-8970
	4 1/2	0.97	2.25	1.00	6V-8536
	4 1/2	0.97	2.25	1.25	138-8455
	5	0.97	2.25	1.75	1K-9414
	6	0.97	2.25	2.50	131-2627
	7	0.97	2.25	2.50	4R-9112
	9	0.97	2.25	5.50	6V-7977
	11 1/2	0.97	2.25	7.50	6V-0659
	12 1/2	0.97	2.25	9.00	127-4840
		Nut			
	Washer				3S-6162

* High strength bolt.

Hardware

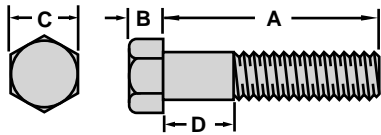

Hex Head Bolts / Inch / Fine Thread UNF / Phosphate & Oil Coated

THREAD SIZE (in - TPI)	A BOLT LENGTH (in)	B HEAD HEIGHT (in)	C HEAD WIDTH (in)	D GRIP LENGTH (in)	PART NUMBER	
1/4-28	1/2	0.19	0.44	0.09	6F-7027	
	5/8	0.19	0.44	0.08	0S-1570	
	3/4	0.19	0.44	0.08	0T-0284	
	7/8	0.19	0.44	0.08	0L-1340	
	1	0.19	0.44	0.25	0S-1597	
	1 1/8	0.19	0.44	0.37	0L-1590	
	1 1/4	0.19	0.44	0.13	4B-2152	
	1 1/2	0.19	0.44	0.75	5F-4475	
	1 3/4	0.19	0.44	1.00	2D-7563	
	2	0.19	0.44	1.25	4B-8701	
	2 1/4	0.19	0.44	1.50	2B-8593	
	2 1/2	0.19	0.44	1.50	1A-9919	
	3	0.19	0.44	2.25	8S-4712	
	3 1/2	0.19	0.44	2.75	8S-4713	
	4	0.19	0.44	3.25	8S-4714	
	4 1/2	0.19	0.44	3.75	8S-4715	
	5	0.19	0.44	4.25	8S-4716	
	Nut					9S-8748
	Washer					5P-0537
5/16-24	1/2	0.24	0.50	0.09	2F-2093	
	5/8	0.24	0.50	0.13	2H-3737	
	3/4	0.24	0.50	0.13	1A-2343	
	7/8	0.24	0.50	0.09	4B-9883	
	1	0.24	0.50	0.13	2H-3738	
	1 1/8	0.24	0.50	0.66	6H-0187	
	1 1/4	0.24	0.50	0.37	1B-1293	
	1 3/8	0.24	0.50	0.50	2A-1371	
	1 1/2	0.24	0.50	0.63	1B-0581	
	1 3/4	0.24	0.50	0.87	2H-3708	
	2	0.24	0.50	1.13	1H-5403	
	2 1/4	0.24	0.50	1.37	2H-3739	
	2 1/2	0.24	0.50	1.63	8S-4717	
	2 3/4	0.24	0.50	1.87	4B-1028	
	3	0.24	0.50	2.13	8S-4718	
	3 1/4	0.24	0.50	2.37	7F-0938	
	3 1/2	0.24	0.50	2.63	8S-4719	
	4	0.24	0.50	3.13	8S-4720	
	4 1/2	0.24	0.50	3.63	8S-4721	

THREAD SIZE (in - TPI)	A BOLT LENGTH (in)	B HEAD HEIGHT (in)	C HEAD WIDTH (in)	D GRIP LENGTH (in)	PART NUMBER	
5/16-24	5	0.24	0.50	4.13	8S-4722	
	Nut				9S-8751	
	Washer				9M-1974	
3/8-24	1/2	0.29	0.56	0.09	0L-1138	
	5/8	0.29	0.56	0.09	0T-0642	
	3/4	0.29	0.56	0.13	0L-0472	
	7/8	0.29	0.56	0.09	0T-0703	
	1	0.29	0.56	0.19	6F-7030	
	1 1/8	0.29	0.56	0.13	5B-2208	
	1 1/4	0.29	0.56	0.25	1A-2209	
	1 3/8	0.29	0.56	0.37	2A-4996	
	1 1/2	0.29	0.56	0.50	0T-0924	
	1 3/4	0.29	0.56	0.75	0L-0478	
	2	0.29	0.56	1.00	0S-1748	
	2 1/4	0.29	0.56	1.25	0L-0639	
	2 1/2	0.29	0.56	1.50	0L-1648	
	2 3/4	0.29	0.56	1.75	0L-0139	
	3	0.29	0.56	2.00	6F-7031	
	3 1/4	0.29	0.56	2.25	0S-1605	
	3 3/4	0.29	0.56	2.50	1B-3680	
	4	0.29	0.56	3.00	0T-0513	
	4 1/4	0.29	0.56	3.25	1B-5082	
	4 1/2	0.29	0.56	3.50	6F-8425	
	5	0.29	0.56	4.00	1A-2116	
	5 1/2	0.29	0.56	4.50	5B-6579	
	6	0.29	0.56	5.00	6F-4736	
	6 1/2	0.29	0.56	5.25	03S-2353	
	8	0.29	0.56	6.75	4H-5883	
	Nut					3S-2713
	Washer					5M-2894
7/16-20	1	0.34	0.69	0.13	0T-0840	
	1 1/4	0.34	0.69	0.13	0T-0244	
	1 1/2	0.34	0.69	0.37	8S-4723	
	1 3/4	0.34	0.69	0.63	1A-4350	
	2	0.34	0.69	0.87	0T-0489	
	2 1/4	0.34	0.69	1.13	8S-4724	
	2 1/2	0.34	0.69	1.37	1B-0572	
	2 3/4	0.34	0.69	1.63	8S-4725	

* High strength bolt.

Hex Head Bolts / Inch / Fine Thread UNF / Phosphate & Oil Coated

THREAD SIZE (in - TPI)	A BOLT LENGTH (in)	B HEAD HEIGHT (in)	C HEAD WIDTH (in)	D GRIP LENGTH (in)	PART NUMBER
7/16-20	3	0.34	0.69	1.87	8S-4726
	3 1/4	0.34	0.63	1.75	5D-4085
	3 1/2	0.34	0.69	2.37	1J-6298
	3 3/4	0.34	0.69	2.63	8S-4727
	4	0.34	0.69	2.87	8S-4728
	4 1/2	0.34	0.69	3.37	8S-4729
	5	0.34	0.69	3.87	8S-4730
	6	0.34	0.69	4.87	8S-4731
	9	0.34	0.69	7.63	2L-4523
	Nut				9S-8905
	Washer				5P-8244
1/2-20	3/4	0.39	0.75	0.13	6F-7032
	7/8	0.39	0.75	0.13	0T-0598
	1	0.39	0.75	0.13	0S-1629
	1 1/4	0.39	0.75	0.13	0S-1593
	1 3/8	0.39	0.75	0.13	4K-7502
	1 1/2	0.39	0.75	0.25	0S-1603
	1 3/4	0.39	0.75	0.50	0S-1584
	2	0.39	0.75	0.75	0S-1579
	2 1/4	0.39	0.75	1.00	0S-0484
	2 1/2	0.39	0.75	1.25	0S-1604
	2 3/4	0.39	0.75	1.50	0S-1599
	3	0.39	0.75	1.75	0L-1732
	3 1/4	0.39	0.75	2.00	0L-1558
	3 1/2	0.39	0.75	2.25	0L-2315
	3 3/4	0.39	0.75	2.50	1A-1952
	4	0.39	0.75	2.75	0L-1559
	4 1/4	0.39	0.75	3.00	6F-7033
	4 1/2	0.39	0.75	3.25	1A-3046
	4 3/4	0.39	0.75	3.50	0L-0557
	5	0.39	0.75	3.75	1B-1422
	5 1/2	0.39	0.75	4.25	3H-1097
	5 3/4	0.39	0.75	4.50	5M-9979
	6	0.39	0.75	4.75	9F-1595
	6 1/2	0.39	0.75	5.00	2H-3747
	7	0.39	0.75	3.37	3H-1930
	7 1/2	0.39	0.75	6.00	2H-3748
	8	0.39	0.75	6.50	1A-3967
	Nut				6B-6684
	Washer				5P-8245

THREAD SIZE (in - TPI)	A BOLT LENGTH (in)	B HEAD HEIGHT (in)	C HEAD WIDTH (in)	D GRIP LENGTH (in)	PART NUMBER
9/16-18	1 1/4	0.43	0.87	0.13	8S-4743
	1 3/8	0.43	0.87	0.13	8S-4761
	1 1/2	0.43	0.87	0.13	8S-4744
	1 3/4	0.43	0.87	0.38	8S-4762
	2	0.43	0.87	0.63	8S-4745
	2 1/4	0.43	0.87	0.88	8S-4763
	2 1/2	0.43	0.87	1.13	8S-4746
	2 3/4	0.43	0.87	1.38	8S-4764
	3	0.43	0.87	1.38	6S-0753
	3 1/2	0.43	0.87	2.13	8S-4747
	3 3/4	0.43	0.87	2.38	2S-1216
	4	0.43	0.87	2.63	8S-4748
	4 1/2	0.43	0.87	3.13	8S-4749
	5	0.43	0.87	3.63	8S-4750
	5 1/2	0.43	0.87	4.13	8S-4751
	6	0.43	0.87	4.63	8S-4752
	Nut				5P-0540
	Washer				5P-8246
	5/8-18	1	0.48	0.94	0.19
1 1/4		0.48	0.94	0.19	1A-4273
1 3/8		0.48	0.94	0.19	4H-4033
1 1/2		0.48	0.94	0.19	2L-1701
1 3/4		0.48	0.94	0.25	5B-0841
2		0.48	0.94	0.50	0S-1576
2 1/4		0.48	0.94	0.75	0S-1577
2 1/2		0.48	0.94	1.00	0S-1600
2 3/4		0.48	0.94	1.25	0S-1601
3		0.48	0.94	1.50	8B-5144
3 1/4		0.48	0.94	1.75	0S-2318
3 1/2		0.48	0.94	2.00	0S-1602
3 3/4		0.48	0.94	2.25	0S-2353
4		0.48	0.94	2.50	0V-0459
4 1/4		0.48	0.94	2.75	0V-0523
4 1/2		0.48	0.94	3.00	0T-0857
4 3/4		0.48	0.94	3.25	1A-3203
5		0.48	0.94	3.50	6F-7024
5 1/2		0.48	0.94	4.00	2A-2814
5 3/4	0.48	0.94	4.25	1B-7538	
6	0.48	0.94	4.50	2B-6030	
7	0.48	0.94	5.25	1B-3623	

* High strength bolt.

Hardware

Hex Head Bolts / Inch / Fine Thread UNF / Phosphate & Oil Coated

THREAD SIZE (in - TPI)	A BOLT LENGTH (in)	B HEAD HEIGHT (in)	C HEAD WIDTH (in)	D GRIP LENGTH (in)	PART NUMBER
5/8-18	7 1/2	0.48	0.94	5.75	7H-5569
	8	0.48	0.94	6.25	8S-4753
	8 1/2	0.48	0.94	6.75	6V-1873
	11	0.48	0.94	9.25	5K-7144
	12	0.48	0.94	10.25	6K-0953
	Nut				6B-6683
	Washer				5P-8247
3/4-16	1 1/4	0.58	1.13	0.19	2H-3740
	1 1/2	0.58	1.13	0.19	2H-3725
	1 3/4	0.58	1.13	0.19	1A-0075
	2	0.58	1.13	0.25	9S-1362
	2 1/4	0.58	1.13	0.50	0S-1897
	2 1/2	0.58	1.13	0.75	0T-0856
	2 3/4	0.58	1.13	1.00	8F-3152
	3	0.58	1.13	1.25	0S-1575
	3 1/4	0.58	1.13	1.50	6B-5310
	3 1/2	0.58	1.13	1.75	9S-1364
	3 3/4	0.58	1.13	2.00	1A-3103
	4	0.58	1.13	2.25	0L-1328
	4 1/4	0.58	1.13	2.50	1D-3419
	4 3/4	0.58	1.13	3.00	7B-5163
	5	0.58	1.13	3.25	0S-1607
	5 1/2	0.58	1.13	3.75	8F-6123
	6	0.58	1.13	4.25	7B-4436
	6 1/2	0.58	1.13	4.50	6F-7901
	7	0.58	1.13	5.00	2H-3749
	7 1/2	0.58	1.13	5.50	2H-3750
	8	0.58	1.13	6.00	4F-0925
	8 1/2	0.58	1.13	6.50	8S-4766
	9	0.58	1.13	7.00	7F-1926
	9 1/2	0.58	1.13	7.50	8B-7943
	10	0.58	1.13	8.00	2K-2813
	11	0.58	1.13	9.00	5P-8288
	11 1/2	0.58	1.13	9.50	2P-9845
Nut				6B-6682	
Washer				5P-8248	
7/8-14	1 1/2	0.67	1.31	0.25	8S-4754
	1 3/4	0.67	1.31	0.25	8F-7496
	2	0.67	1.31	0.25	2H-3854
	2 1/4	0.67	1.31	0.25	6F-7035
	2 1/2	0.67	1.31	0.50	1D-5873
	2 3/4	0.67	1.31	0.75	0S-1596

THREAD SIZE (in - TPI)	A BOLT LENGTH (in)	B HEAD HEIGHT (in)	C HEAD WIDTH (in)	D GRIP LENGTH (in)	PART NUMBER
7/8-14	3	0.67	1.31	1.00	6F-7036
	3 1/4	0.67	1.31	1.25	2H-3741
	3 1/2	0.67	1.31	1.50	1A-0224
	3 3/4	0.67	1.31	1.75	0L-2090*
	4	0.67	1.31	2.00	0T-0603
	4 1/4	0.67	1.31	2.25	1D-3848
	4 1/2	0.67	1.31	2.50	4H-8340
	5	0.67	1.31	3.00	1D-6089
	5 1/2	0.67	1.31	3.50	0S-1606
	6	0.67	1.31	4.00	7F-6100
	6 1/2	0.67	1.31	4.25	6F-4991
	7	0.67	1.31	4.75	4F-6426
	7 1/2	0.67	1.31	5.25	2K-1747
	8	0.67	1.31	5.75	7F-0479
	9	0.67	1.31	6.75	2L-1091
	11	0.67	1.31	8.75	3B-4978
	11 1/2	0.67	1.31	9.25	4B-7572
	Nut				1A-5666
	Washer				5P-8249
	1-14	1 1/2	0.71	1.50	0.13
1 3/4		0.71	1.50	0.13	8S-4756
2		0.71	1.50	0.25	2H-3743
2 1/4		0.71	1.50	0.25	2H-3744
2 1/2		0.71	1.50	0.25	5B-9385
2 3/4		0.71	1.50	0.50	2H-3745
3		0.71	1.50	0.75	6B-9194
3 1/4		0.71	1.50	1.00	6F-7037
3 1/2		0.71	1.50	1.25	9S-1368
3 3/4		0.71	1.50	1.50	9S-1367
4		0.71	1.50	1.75	1F-7464*
4 1/2		0.71	1.50	2.25	0V-0269
4 3/4		0.71	1.50	2.50	7B-7181
5		0.71	1.50	2.75	2H-3746
5 1/2		0.71	1.50	3.25	8F-6124
6		0.71	1.50	3.75	3F-6645
6 1/2		0.71	1.50	4.00	7F-4283
7		0.71	1.50	4.50	5F-6932
7 1/2	0.71	1.50	5.00	2H-0637	
8	0.71	1.50	5.50	8S-4757	
8 1/2	0.71	1.50	6.00	3J-5981	
9	0.71	1.50	6.50	9F-8122	
9 1/2	1.50	0.39	7.00	5F-7136	

* High strength bolt.

Hex Head Bolts / Inch / Fine Thread UNF / Phosphate & Oil Coated

THREAD SIZE (in - TPI)	A BOLT LENGTH (in)	B HEAD HEIGHT (in)	C HEAD WIDTH (in)	D GRIP LENGTH (in)	PART NUMBER
1-14	10	0.71	1.50	7.50	1L-8586
	Nut				1A-1935
	Washer				5P-8250
1 1/8-12	2 1/4	0.72	1.69	0.31	1A-2208
	2 1/2	0.72	1.69	0.50	2H-3751
	3 1/4	0.72	1.69	2.00	8B-0477
	4	0.72	1.69	1.50	8F-3895
	4 1/2	0.72	1.69	2.00	8H-4040
	5	0.72	1.69	2.50	7B-9215
	5 1/2	0.72	1.69	3.00	4B-5219
	6	0.72	1.69	3.50	2D-3424
	6 1/2	0.72	1.69	3.75	3B-5752
	7	0.72	1.69	4.25	2D-8930
	7 1/2	0.72	1.69	4.75	9M-3742
	8	0.72	1.69	5.25	1S-3647
	9	0.72	1.69	6.25	2M-3530
	Nut				3S-1356
	Washer				3S-1349
1 1/4-12	2 1/4	0.81	1.87	0.25	7B-2289
	3	0.81	1.87	0.25	7F-6112
	3 1/2	0.81	1.87	0.75	2K-0439
	4	0.81	1.87	1.25	5P-2663
	4 3/4	0.81	1.87	2.00	7B-8791
	5 1/2	0.81	1.87	2.75	2J-2555
	6	0.81	1.87	3.25	5H-1649
	6 1/2	0.81	1.87	3.50	4H-6511
	7 1/2	0.81	1.87	4.50	7F-9464
	8	0.81	1.87	5.00	4J-0924
	8 1/2	0.81	1.87	5.50	5F-9339
	9 1/2	0.81	1.87	6.50	3S-7079
	10	0.81	1.87	7.00	4H-8009
	11 1/2	0.81	1.87	8.38	6F-4438
	12	0.81	1.87	9.00	7H-3579
13	0.81	1.87	10.88	4H-2400	
Nut				7H-7539	
Washer				4K-0684	
1 1/2-12	3	0.97	2.25	0.25	7X-3305
	3 3/4	0.97	2.25	0.50	1J-2921
	4	0.97	2.25	0.75	8F-5535
	4 1/2	0.97	2.25	1.25	1F-6762
	5	0.97	2.25	1.75	5P-9402

THREAD SIZE (in - TPI)	A BOLT LENGTH (in)	B HEAD HEIGHT (in)	C HEAD WIDTH (in)	D GRIP LENGTH (in)	PART NUMBER
1 1/2-12	6	0.97	2.25	2.75	5F-9891
	7	0.97	2.25	3.50	8F-1692
	8	0.97	2.25	4.50	2D-7687
	9	0.97	2.25	5.50	5F-3492
	10	0.97	2.25	7.48	5P-9384
	Nut				8H-3390
	Washer				3S-6162
2-12	8	0.97	3.00	1.75	5R-8907

* High strength bolt.

Hardware

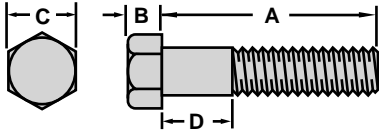

Hex Head Bolts / Inch / Coarse Thread UNC / Zinc Dichromate Plated

THREAD SIZE (in - TPI)	A BOLT LENGTH (in)	B HEAD HEIGHT (in)	C HEAD WIDTH (in)	D GRIP LENGTH (in)	PART NUMBER
1/4-20	1/2	0.19	0.44	0.06	5S-7349
	5/8	0.19	0.44	0.13	8T-9364
	3/4	0.19	0.44	0.13	4M-5281
	7/8	0.19	0.44	0.13	1H-3337
	1	0.19	0.44	0.13	8T-8908
	1 1/8	0.19	0.44	0.37	6D-2928
	1 1/4	0.19	0.44	0.13	7X-2501
	1 1/2	0.19	0.44	0.25	4M-5282
	1 3/4	0.19	0.44	1.00	5P-2675
	2	0.19	0.44	1.13	8T-9367
	2 1/4	0.19	0.44	1.37	8T-9368
	2 1/2	0.19	0.44	1.75	7X-0264
	2 3/4	0.19	0.44	2.00	7X-0265
	3	0.19	0.44	2.00	7X-0266
	3 1/4	0.19	0.44	2.50	7X-0267
	3 1/2	0.19	0.44	2.75	7X-0268
	3 3/4	0.19	0.44	3.00	8C-3793
	4	0.19	0.44	3.25	7X-0269
	5	0.19	0.44	4.25	8T-8909
	5 1/2	0.19	0.44	4.50	7X-0271
Nut				6V-8185	
Washer				8T-4205	
5/16-18	1/2	0.24	0.50	0.06	8T-5391
	5/8	0.24	0.50	0.13	5K-0906
	3/4	0.24	0.50	0.13	4M-0061
	7/8	0.24	0.50	0.13	8T-9043
	1	0.24	0.50	0.13	4M-6425
	1 1/8	0.24	0.50	0.25	6V-5782
	1 1/4	0.24	0.50	0.37	6V-8918
	1 1/2	0.24	0.50	0.09	8C-3121
	1 3/4	0.24	0.50	0.87	7X-0440
	2	0.24	0.50	1.13	8T-8911
	2 1/4	0.24	0.50	1.37	8T-8912
	2 1/2	0.24	0.50	1.63	5P-2955
	2 3/4	0.24	0.50	1.87	7X-0274
	3	0.24	0.50	2.13	4M-6424
	3 1/4	0.24	0.50	2.25	7X-0275
	3 1/2	0.24	0.50	2.63	7X-0276
	3 3/4	0.24	0.50	2.75	7X-0277

THREAD SIZE (in - TPI)	A BOLT LENGTH (in)	B HEAD HEIGHT (in)	C HEAD WIDTH (in)	D GRIP LENGTH (in)	PART NUMBER
5/16-18	4	0.24	0.50	3.00	7X-0278
	4 3/4	0.24	0.50	3.87	7X-0279
	5	0.24	0.50	4.13	7X-0280
	5 1/2	0.24	0.50	4.63	7X-0281
	6 1/2	0.24	0.50	5.37	7X-0282
	Nut				6V-8189
	Washer				8T-4224
	3/8-16	1/2	0.29	0.56	0.09
5/8		0.29	0.56	0.09	5P-8167
3/4		0.29	0.56	0.13	5M-3062
7/8		0.29	0.56	0.13	5S-7379
1		0.29	0.56	0.13	4L-6454
1 1/8		0.29	0.56	0.31	8T-2502
1 1/4		0.29	0.56	0.25	9B-7237
1 1/2		0.29	0.56	0.37	4L-9337
1 3/4		0.29	0.56	0.75	5S-7383
2		0.29	0.56	1.00	8T-2501
2 1/4		0.29	0.56	1.25	8T-9377
2 1/2		0.29	0.56	1.50	4L-6459
2 3/4		0.29	0.56	1.75	8T-9101
3		0.29	0.56	2.00	8T-7008
3 1/4		0.29	0.56	2.25	8T-8915
3 1/2		0.29	0.56	2.50	7X-0290
3 3/4		0.29	0.56	2.50	7X-0291
4		0.29	0.56	3.00	8T-9378
4 1/4		0.29	0.56	3.25	8T-9379
4 1/2		0.29	0.56	3.25	7X-0292
4 3/4		0.29	0.56	3.75	7X-0293
5		0.29	0.56	4.00	7X-0294
5 1/4		0.29	0.56	4.25	7X-0295
5 1/2		0.29	0.56	4.50	7X-0296
5 3/4	0.29	0.56	4.75	7X-0297	
6	0.29	0.56	4.87	8C-7323	
6 1/2	0.29	0.56	5.25	7X-0300	
7	0.29	0.56	5.75	7X-0301	
7 1/2	0.29	0.56	6.25	7X-0302	
8	0.29	0.56	6.75	7X-0303	
8 1/2	0.29	0.56	7.25	7X-0304	
9	0.29	0.56	7.75	7X-0305	

Hex Head Bolts / Inch / Coarse Thread UNC / Zinc Dichromate Plated

THREAD SIZE (in - TPI)	A BOLT LENGTH (in)	B HEAD HEIGHT (in)	C HEAD WIDTH (in)	D GRIP LENGTH (in)	PART NUMBER
3/8-16	9 1/2	0.29	0.56	8.25	4H-3283
	Nut				6V-8801
	Washer				8T-4896
7/16-14	3/4	0.34	0.69	0.19	7X-0307
	7/8	0.34	0.69	0.13	7X-0272
	1	0.34	0.69	0.13	8T-9380
	1 1/8	0.34	0.69	0.13	8T-6973
	1 1/4	0.34	0.69	0.13	8T-9382
	1 1/2	0.34	0.69	0.37	8T-8916
	1 3/4	0.34	0.69	0.63	8C-6877
	2	0.34	0.69	0.87	7X-0310
	2 1/4	0.34	0.69	1.13	7X-0311
	2 1/2	0.34	0.69	1.37	7X-0312
	2 3/4	0.34	0.69	1.63	7X-0313
	3	0.34	0.69	1.87	7X-0314
	3 1/4	0.34	0.69	2.13	7X-0315
	3 1/2	0.34	0.69	2.37	7X-0316
	3 3/4	0.34	0.69	2.63	7X-0317
	4	0.34	0.69	2.87	7X-0318
	4 1/4	0.34	0.69	3.13	7X-0319
	4 3/4	0.34	0.69	3.63	7H-3472
	5	0.34	0.69	3.75	7X-0320
	5 1/2	0.34	0.69	4.37	7X-0321
	6	0.34	0.69	4.87	7X-0322
	Nut				7X-0447
	Washer				8T-5360
1/2-13	3/4	0.39	0.75	0.13	8T-9383
	7/8	0.39	0.75	0.28	8T-9384
	1	0.39	0.75	0.13	5P-2228
	1 1/8	0.39	0.75	0.13	5C-6565
	1 1/4	0.39	0.75	0.31	8T-8917
	1 1/2	0.39	0.75	0.25	5P-2566
	1 3/4	0.39	0.75	0.44	8T-8919
	2	0.39	0.75	0.75	8T-4835
	2 1/4	0.39	0.75	1.00	5P-2424
	2 1/2	0.39	0.75	1.25	7X-0325
	2 3/4	0.39	0.75	1.50	8T-9389
	3	0.39	0.75	1.75	7X-0326
	3 1/4	0.39	0.75	2.00	8T-8920
	3 1/2	0.39	0.75	2.25	7X-0328
	3 3/4	0.39	0.75	2.50	8T-9391
	4	0.39	0.75	2.75	6V-4432
	4 1/4	0.39	0.75	3.00	7X-0331

THREAD SIZE (in - TPI)	A BOLT LENGTH (in)	B HEAD HEIGHT (in)	C HEAD WIDTH (in)	D GRIP LENGTH (in)	PART NUMBER
1/2-13	4 1/2	0.39	0.75	3.25	7X-0332
	4 3/4	0.39	0.75	3.50	7X-0333
	5	0.39	0.75	3.75	7X-0334
	5 1/4	0.39	0.75	4.00	7X-0335
	5 1/2	0.39	0.75	4.25	7X-0336
	5 3/4	0.39	0.75	4.50	7X-0337
	6	0.39	0.75	4.75	7X-0338
	6 1/2	0.39	0.75	5.00	7X-0340
	7	0.39	0.75	5.50	7X-0341
	7 1/2	0.39	0.75	6.00	8T-9392
	8 1/2	0.39	0.75	7.00	7X-0471
	Nut				6V-8188
	Washer				8T-4223
	9/16-12	2	0.43	0.87	0.63
5/8-11	1	0.48	0.94	0.19	5C-6266
	1 1/4	0.48	0.94	0.19	7X-0343
	1 1/2	0.48	0.94	0.19	8T-9393
	1 3/4	0.48	0.94	0.25	7X-0345
	2 1/4	0.48	0.94	0.75	7X-0347
	2 1/2	0.48	0.94	0.63	8T-6871
	2 3/4	0.48	0.94	1.25	8C-6362
	3	0.48	0.94	1.50	7X-0349
	3 1/4	0.48	0.94	1.75	8T-9396
	3 1/2	0.48	0.94	2.00	7X-0350
	3 3/4	0.48	0.94	2.25	7X-0351
	4	0.48	0.94	2.50	7X-0352
	4 1/4	0.48	0.94	2.75	7X-0353
	4 1/2	0.48	0.94	3.00	7X-0354
	4 3/4	0.48	0.94	3.25	7X-0355
	5	0.48	0.94	3.50	7X-0356
	5 1/4	0.48	0.94	3.75	7X-0357
	5 1/2	0.48	0.94	4.00	7X-0358
	6	0.48	0.94	4.50	7X-0359
	6 1/2	0.48	0.94	4.75	7X-0361
7	0.48	0.94	5.25	7X-0362	
8	0.48	0.94	6.25	7X-0363	
8 1/2	0.48	0.94	6.75	7X-0364	
9 1/2	0.48	0.94	7.75	7X-7890	
Nut				7X-0448	
Washer				8T-4122	
3/4-10	1 1/4	0.58	1.13	0.31	8T-9397
	1 1/2	0.58	1.13	0.31	7X-0365
	1 3/4	0.58	1.13	0.31	8T-9398

Hardware

Hex Head Bolts / Inch / Coarse Thread UNC / Zinc Dichromate Plated

THREAD SIZE (in - TPI)	A BOLT LENGTH (in)	B HEAD HEIGHT (in)	C HEAD WIDTH (in)	D GRIP LENGTH (in)	PART NUMBER
3/4-10	2	0.58	1.13	0.31	7X-0366
	2 1/4	0.58	1.13	0.50	8T-9399
	2 1/2	0.58	1.13	0.75	8T-8924
	2 3/4	0.57	1.13	1.00	8C-6857
	3	0.58	1.13	1.25	7X-0368
	3 1/4	0.58	1.13	1.50	7X-0369
	3 1/2	0.58	1.13	1.75	7X-0370
	3 3/4	0.58	1.13	2.00	7X-0371
	4	0.58	1.13	2.25	8C-8842
	4 1/4	0.58	1.13	2.50	7X-0372
	4 1/2	0.58	1.13	2.75	8T-9311
	4 3/4	0.58	1.13	3.00	8T-8925
	5	0.58	1.13	3.25	7X-0375
	5 1/2	0.58	1.13	3.75	7X-0373
	5 3/4	0.58	1.13	4.00	7X-0374
	6	0.58	1.13	4.25	8T-9312
	6 1/2	0.58	1.13	4.50	7X-0377
	7	0.58	1.13	5.00	8T-9313
	7 1/2	0.58	1.13	5.50	1J-8930
	8	0.58	1.13	6.00	5P-4135
	8 1/2	0.58	1.13	6.50	7X-0378
9	0.58	1.13	7.00	7X-3179	
10	0.58	1.13	8.00	8F-4225	
Nut				6V-8182	
Washer				8T-4994	
7/8-9	1 1/2	0.67	1.31	0.25	7X-0379
	1 3/4	0.67	1.31	0.37	7X-0380
	2	0.67	1.31	0.37	7X-0381
	2 1/4	0.67	1.31	0.37	7X-0382
	2 1/2	0.67	1.31	0.50	8T-9400
	2 3/4	0.67	1.31	0.75	7X-0383
	3	0.67	1.31	1.00	7X-0384
	3 1/4	0.67	1.31	1.25	7X-0385
	3 1/2	0.67	1.31	1.50	7X-0386
	3 3/4	0.67	1.31	1.75	7X-0453
	4	0.67	1.31	2.00	7X-0387
	4 1/4	0.67	1.31	2.25	7X-0455
	4 1/2	0.67	1.31	2.50	7X-0388
	4 3/4	0.67	1.31	2.75	7X-0389
	5	0.67	1.31	3.00	7X-0390
	5 1/2	0.67	1.31	3.50	7X-0391
	6	0.67	1.31	3.75	7X-0392
	6 1/2	0.67	1.31	4.25	7X-0393

THREAD SIZE (in - TPI)	A BOLT LENGTH (in)	B HEAD HEIGHT (in)	C HEAD WIDTH (in)	D GRIP LENGTH (in)	PART NUMBER
7/8-9	7	0.67	1.31	4.75	7X-0394
	8	0.67	1.31	5.75	7X-0395
	8 1/2	0.67	1.31	6.25	7X-0396
	9	0.67	1.31	6.75	7X-0397
	10	0.67	1.31	7.75	7X-0398
	Nut				7X-0449
	Washer				8C-6913
	1-8	1 1/4	0.71	1.50	0.31
1 1/2		0.71	1.50	0.31	7X-0400
1 3/4		0.71	1.50	0.37	7X-0401
2		0.71	1.50	0.75	7X-0402
2 1/4		0.71	1.50	0.25	7X-0403
2 1/2		0.71	1.50	0.50	7X-0404
2 3/4		0.71	1.50	0.50	7X-0405
3		0.71	1.50	0.75	7X-0406
3 1/4		0.71	1.50	1.00	7X-0407
3 1/2		0.71	1.50	1.25	7X-0408
3 3/4		0.71	1.50	1.50	8T-8927
4		0.71	1.50	1.75	7X-0410
4 1/4		0.71	1.50	2.00	7X-0411
4 1/2		0.71	1.50	2.25	8C-8843
4 3/4		0.71	1.50	2.50	7X-0412
5		0.71	1.50	2.75	8C-8844
5 1/2		0.71	1.50	3.25	7X-0443
6		0.71	1.50	3.75	1J-5929
6 1/2		0.71	1.50	4.00	7X-0444
7		0.71	1.50	4.50	7X-0413
7 1/2		0.71	1.50	5.00	7X-0414
8		0.71	1.50	5.50	7X-0415
8 1/2		0.71	1.50	6.00	7X-0416
9	0.71	1.50	6.50	7X-0417	
9 1/2	0.71	1.50	7.00	7X-0418	
10	0.71	1.50	7.50	7X-0419	
Nut				6V-8190	
Washer				8T-5361	
1 1/8-7	2	0.72	1.69	0.25	7X-0420
	3	0.72	1.69	0.50	7X-0421
	3 1/2	0.72	1.69	1.00	7X-0422
	4 1/2	0.72	1.69	2.00	7X-0423
	5 1/4	0.72	1.69	3.00	7X-0424
	6	0.72	1.69	3.50	7X-0425
	6 1/2	0.72	1.69	3.75	7X-0426
	Nut				7X-0450

Hex Head Bolts / Inch / Coarse Thread UNC / Zinc Dichromate Plated

THREAD SIZE (in - TPI)	A BOLT LENGTH (in)	B HEAD HEIGHT (in)	C HEAD WIDTH (in)	D GRIP LENGTH (in)	PART NUMBER
1 1/8-7	Washer				7X-0531
1 1/4-7	3 1/2	0.81	1.87	0.75	7X-0427
	4	0.81	1.87	1.25	7X-0428
	4 1/2	0.81	1.87	1.75	7X-0429
	5	0.81	1.87	2.25	7X-0445
	5 1/2	0.81	1.87	2.75	7X-0430
	6	0.81	1.87	3.25	7X-0431
	6 1/2	0.81	1.87	3.50	7X-0432
	7	0.81	1.87	4.00	7X-0433
	8	0.81	1.87	5.00	7X-0434
	8 1/2	0.81	1.87	5.50	7X-0435
	9	0.81	1.87	6.00	7X-0436
	9 1/2	0.81	1.87	6.50	7X-0437
	Nut				7X-0451
Washer				7X-0533	
1 1/2-6	3 1/2	0.97	2.25	0.40	7X-0438
	4 1/2	0.97	2.25	1.25	138-8455
	5	0.97	2.25	1.75	7X-0439
	6	0.97	2.25	2.50	131-2627
	Nut				7X-0452

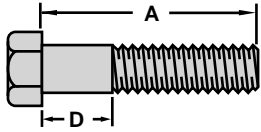

Self-Locking Bolts / Inch / Coarse Thread UNC

THREAD SIZE (in - TPI)	A BOLT LENGTH (in)	D GRIP LENGTH (in)	PART NUMBER
1/4-20	3/8	0.06	032-5691
	1/2	0.06	031-0214
	5/8	0.13	031-0215
	3/4	0.13	031-0216
	7/8	0.10	031-0217
	1	0.13	031-5085
	1 1/8	0.37	6V-7634
	1 1/4	0.13	6V-6845
	4	3.25	3J-8919
5/16-18	1/2	0.06	032-5473
	5/8	0.13	030-2135
	3/4	0.13	031-4630
	1	0.13	034-4160
	1 1/4	0.37	031-2701
	1 1/2	0.09	6V-4414
	1 5/8	0.87	1N-7543
	2	1.13	6V-9665
	2 1/4	1.37	6V-2664
	2 1/2	1.63	6V-0825
	3	2.13	6V-3314
3/8-16	1/2	0.09	031-0218
	5/8	0.13	6K-4936
	3/4	0.13	5K-9107
	7/8	0.13	030-8535
	1	0.13	5D-0353
	1 1/8	0.31	034-3557
	1 1/4	0.25	2J-3118
	1 1/2	0.50	030-8537
	1 3/4	0.75	031-0219
	2	1.00	5D-9844
	2 1/4	1.25	5P-8048
	2 1/2	1.50	031-0220
	3	2.00	5K-5552
	3 1/2	2.50	6V-8819
	7/16-14	3/4	0.13
1		0.13	034-0106
1 1/4		0.13	031-2523
1 1/2		0.37	5P-8282
2		0.87	5P-8864

THREAD SIZE (in - TPI)	A BOLT LENGTH (in)	D GRIP LENGTH (in)	PART NUMBER
1/2-13	3/4	0.13	031-0221
	7/8	0.13	6K-5718
	1	0.13	6K-7917
	1 1/8	0.13	5K-8454
	1 1/4	0.31	030-8538
	1 1/2	0.25	5K-7143
	1 3/4	0.44	031-0223
	2	0.75	6V-0314
	2 1/4	1.00	030-9620
	2 3/4	1.50	034-0172
	3 1/4	2.00	5P-8091
5/8-11	1	0.19	5K-7138
	1 1/4	0.13	6K-0138
	1 1/2	0.19	030-7335
	1 3/4	0.25	7K-4370
	2	0.50	6K-0137
	2 1/4	0.75	5P-7034
	2 1/2	0.63	5P-9118
	2 3/4	1.25	6V-1997
	3	1.50	032-0676
	3 3/4	2.25	5P-7782
3/4-10	1 1/4	0.31	031-2712
	1 1/2	0.31	031-9253
	1 3/4	0.31	031-0224
	2	0.31	031-0225
	2 1/4	0.50	5P-3882
	2 1/2	0.75	6K-1304
	3	1.25	5P-6712
	3 1/2	1.75	6V-1684
	4 1/2	2.75	5P-1910
	7/8-9	2 1/2	0.50
1-8	2 3/4	0.50	5P-7783
	3 1/2	1.25	7K-9272
	5 1/2	3.25	032-0679
1 1/8-7	3 1/2	1.00	7J-9897

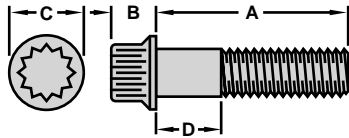

12 Point Head Bolts / Inch / Coarse & Fine Thread

THREAD SIZE (in - TPI)	A BOLT LENGTH (in)	B HEAD HEIGHT (in)	C HEAD WIDTH (in)	D GRIP LENGTH (in)	PART NUMBER
COARSE THREAD					
1/4-20	1/16	0.27	0.38	0.11	9S-5033
5/16-18	3/4	0.31	0.47	0.11	1T-0416
	1	0.31	0.47	0.11	1T-0414
	1 1/4	0.31	0.47	0.11	6L-4783
	1 1/2	0.31	0.47	0.11	8M-8162
	1 1/2	0.31	0.47	0.63	2N-7517
	1 3/4	0.31	0.47	0.63	6L-4784
	2 1/2	0.31	0.47	1.13	3S-4346
	3	0.31	0.47	1.63	2S-5818
	3 1/2	0.31	0.47	2.25	2S-0629
	4 1/2	0.31	0.47	3.25	9M-4288
	5	0.31	0.47	3.63	9M-4289
	5 1/2	0.31	0.47	4.25	1S-9810
	6	0.31	0.47	4.63	1S-9811
	6 1/2	0.31	0.47	5.25	4S-5845
3/8-16	3/4	0.38	0.56	0.25	1T-0822
	1	0.38	0.56	0.25	1T-0765
	1 1/16	0.38	0.56	0.50	4D-5239
	1 1/4	0.38	0.56	0.25	1T-0720
	2	0.38	0.56	0.50	3S-1307
	2 1/4	0.38	0.56	1.00	3S-0127
	2 3/4	0.38	0.56	1.50	2S-3567
	3	0.38	0.56	1.50	4S-9002
	3 3/4	0.38	0.56	2.50	8M-2518
7/16-14	1 1/2	0.44	0.66	0.14	6K-3771
	2 1/4	0.44	0.66	0.63	6K-3772
1/2-13	1	0.50	0.75	0.16	9M-6590
	1 1/4	0.50	0.75	0.16	8M-2530
	1 1/2	0.50	0.75	0.16	4K-5175
	2	0.50	0.75	0.16	5J-5793
	2 1/4	0.50	0.75	0.75	6J-2515
	2 1/2	0.50	0.75	1.00	7K-6058
	2 3/4	0.50	0.75	0.75	9S-9739
	3 1/2	0.50	0.75	1.50	5J-5794
	4 1/2	0.50	0.75	3.00	8D-0648

THREAD SIZE (in - TPI)	A BOLT LENGTH (in)	B HEAD HEIGHT (in)	C HEAD WIDTH (in)	D GRIP LENGTH (in)	PART NUMBER
5/8-11	7/8	0.62	0.94	0.19	1S-9808
	1	0.62	0.94	0.19	9S-8889
	1 3/4	0.62	0.94	0.19	8S-2332
	2	0.62	0.94	0.19	8S-2331
	2 1/4	0.62	0.94	0.50	6M-9149
	2 1/2	0.62	0.94	0.75	031-1382
	3	0.62	0.94	1.25	031-3185
	3 1/4	0.62	0.94	1.50	6J-3913
3/4-10	3 1/2	0.62	0.94	1.50	7K-3116
	1 1/2	0.75	1.13	0.25	6J-3991
	1 3/4	0.75	1.13	0.19	6M-8796
FINE THREAD					
5/16-24	3/4	0.31	0.47	0.08	5D-8269
3/8-24	5/8	0.38	0.56	0.08	1T-0510
	1	0.38	0.56	0.08	1T-0417
	1 1/4	0.38	0.56	0.08	1T-0448
	1 3/4	0.38	0.56	0.50	1T-0954
	2 1/2	0.38	0.56	1.00	5K-4451
7/16-20	2 3/4	0.44	0.66	1.25	5J-7820
1/2-20	3	0.50	0.75	1.50	8S-0509
5/8-18	1	0.62	0.94	0.19	9S-8890
	2 1/2	0.62	0.94	0.75	9S-8891
	3	0.62	0.94	0.75	2P-1956
3/4-16	3 1/4	0.75	1.13	1.00	9S-8892
7/8-14	2 1/2	0.88	1.31	0.16	2N-5014
1-14	2 1/2	1.00	1.50	0.75	2N-5006
	4	1.00	1.50	1.00	9S-8893

Hardware

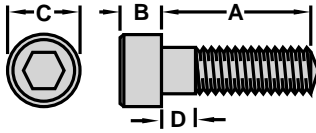

Hex Socket Head Screw Bolts / Inch / Coarse & Fine Thread

THREAD SIZE (in - TPI)	A BOLT LENGTH (in)	B HEAD HEIGHT (in)	C HEAD WIDTH (in)	D GRIP LENGTH (in)	PART NUMBER
COARSE THREAD					
No. 4-40	3/8	0.11	0.19	0.05	2S-9255
No. 8-32	1/2	0.16	0.27	0.06	6D-3897
	3/4	0.16	0.27	0.06	7D-5473
	1	0.16	0.27	0.06	9M-4704
No. 10-24	1/2	0.19	0.31	0.08	5S-2671
	5/8	0.19	0.31	0.08	2H-0191
	3/4	0.19	0.31	0.08	3L-2540
	7/8	0.19	0.31	0.08	9F-1707
	1 1/4	0.19	0.31	0.38	7L-0688
	1 1/2	0.19	0.31	0.38	5J-1714
1/4-20	1 3/4	0.19	0.31	0.88	2N-0402
	3/8	0.25	0.38	0.11	7J-0637
	1/2	0.25	0.38	0.11	8H-0708
	5/8	0.25	0.38	0.11	8H-3128
	3/4	0.25	0.38	0.11	8H-3127
	7/8	0.25	0.38	0.11	6L-5897
	1	0.25	0.38	0.11	8H-0707
	1 1/4	0.25	0.38	0.09	4L-7124
	1 1/2	0.25	0.38	0.50	2H-3764
	1 3/4	0.25	0.38	0.50	5L-9018
	2	0.25	0.38	1.00	6L-1596
	2 1/4	0.25	0.38	1.00	6L-5551
	2 1/2	0.25	0.38	1.50	6H-3958
	2 3/4	0.25	0.38	1.50	6J-2819
5/16-18	3/4	0.31	0.47	0.11	9F-5975
	1	0.31	0.47	0.11	1T-0284
	1 1/4	0.31	0.47	0.11	9F-6641
	1 1/2	0.31	0.47	0.11	5J-5314
	1 3/4	0.31	0.47	0.63	7S-6701
	2	0.31	0.47	0.63	9S-7381
	2 3/4	0.31	0.47	1.63	2L-1352
	3 1/2	0.31	0.47	2.25	9S-7382
3/8-16	3/4	0.38	0.56	0.25	1L-0509
	7/8	0.38	0.56	0.25	4S-5565
	1	0.38	0.56	0.25	2D-4534
	1 1/4	0.38	0.56	0.25	2J-5245
	1 1/2	0.38	0.56	0.25	4D-3120
	1 3/4	0.38	0.56	0.50	5S-2586

THREAD SIZE (in - TPI)	A BOLT LENGTH (in)	B HEAD HEIGHT (in)	C HEAD WIDTH (in)	D GRIP LENGTH (in)	PART NUMBER
3/8-16	2	0.38	0.56	0.50	1L-8793
	2 1/4	0.38	0.56	1.00	2L-3793
	2 1/2	0.38	0.56	1.00	1Y-7574
	2 3/4	0.38	0.56	1.50	2K-6073
	3 1/4	0.38	0.56	2.00	4B-3835
	4	0.38	0.56	2.50	3B-7614
	5	0.38	0.56	3.50	8L-3837
	6	0.38	0.56	4.50	2D-8992
	7/16-14	7/8	0.44	0.66	0.14
1 1/4		0.44	0.66	0.14	7B-7525
2		0.44	0.66	0.63	2N-0412
2 1/2		0.44	0.66	1.13	3J-4567
1/2-13	1/2	0.50	0.75	0.16	021-7916
	3/4	0.50	0.75	0.16	013-8289
	1	0.50	0.75	0.16	5H-4893
	1 1/4	0.50	0.75	0.16	5F-8807
	1 1/2	0.50	0.75	0.16	3F-7147
	1 3/4	0.50	0.75	0.16	5S-2256
	2	0.50	0.75	0.19	8B-7997
	2 1/4	0.50	0.75	0.75	2L-0041
	2 1/2	0.50	0.75	0.75	8B-7979
	2 3/4	0.50	0.75	0.75	5S-2389
	3	0.50	0.75	1.50	4L-8515
	3 1/4	0.50	0.75	1.50	6D-0119
	3 1/2	0.50	0.75	1.50	8B-7998
	5	0.50	0.75	3.00	5S-2388
	6	0.50	0.75	4.50	8L-4612
7	0.50	0.75	5.25	7L-0654	
5/8-11	1 1/4	0.62	0.94	0.19	5S-2201
	2	0.62	0.94	0.19	5S-2457
	3	0.62	0.94	0.75	4D-0242
	4	0.62	0.94	2.25	8L-4743
	4 1/2	0.62	0.94	2.25	6H-3959
	5 1/2	0.62	0.94	3.75	7L-8304
3/4-10	1 1/2	0.75	1.12	0.20	7L-9787
	1 3/4	0.75	1.12	0.20	5F-5321
	2 1/2	0.75	1.12	0.20	2N-6170
	3 1/4	0.75	1.12	1.00	2N-1746
	3 1/2	0.75	1.12	1.00	9S-4920

Hex Socket Head Screw Bolts / Inch / Coarse & Fine Thread

THREAD SIZE (in - TPI)	A BOLT LENGTH (in)	B HEAD HEIGHT (in)	C HEAD WIDTH (in)	D GRIP LENGTH (in)	PART NUMBER
7/8-9	2 1/2	0.88	1.31	0.22	8L-4638
	4	0.88	1.31	1.00	8L-9299
	4 1/2	0.88	1.31	3.00	8L-4717
1-8	2 1/2	1.00	1.50	0.25	8L-6059
	3	1.00	1.50	0.25	7L-9198
	5	1.00	1.50	2.00	8L-3745
FINE THREAD					
No. 10-32	5/8	0.19	0.31	0.06	3K-6168
	7/8	0.19	0.31	0.06	8H-4959
1/4-28	1/2	0.25	0.38	0.08	2K-8407
	5/8	0.25	0.38	0.08	021-7941
	3/4	0.25	0.38	0.08	3H-1392
	7/8	0.25	0.38	0.08	8S-1571
5/16-24	3/4	0.31	0.47	0.08	3F-8156
3/8-24	3/4	0.38	0.56	0.08	013-8253
	7/8	0.38	0.56	0.08	4L-1507
	1	0.38	0.56	0.08	5L-4183
	1 1/4	0.38	0.56	0.08	1T-0131
	1 1/2	0.38	0.56	0.19	5L-8894
	1 3/4	0.38	0.56	0.50	013-8257
	2	0.38	0.56	0.50	013-8258
	2 1/4	0.38	0.56	1.00	013-8259
	5 3/4	0.38	0.56	4.75	8J-1582
7/16-20	1/2	0.44	0.66	0.11	8S-2696
	1 3/4	0.44	0.66	0.11	8F-1948
1/2-20	1/2	0.50	0.75	0.11	021-7956
	3/4	0.50	0.75	0.11	013-8306
	1	0.50	0.75	0.11	013-8307
	1 1/4	0.50	0.75	0.11	1F-1375
	1 1/2	0.50	0.75	0.11	8F-0069
	1 3/4	0.50	0.75	0.11	013-8310
	2	0.50	0.75	0.11	2H-3763
	2 1/4	0.50	0.75	0.75	013-8312
3	0.50	0.75	1.50	013-8315	
5/8-18	2 1/4	0.62	0.94	0.11	9S-9078
3/4-16	2	0.75	1.12	0.13	061-8718

Hardware

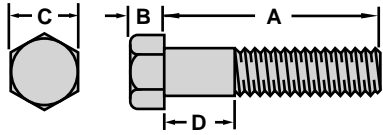

Hex Head Bolts / Metric / Coarse Thread UNC / Phosphate & Oil Coated

THREAD SIZE (dia x pitch)	A BOLT LENGTH (mm)	B HEAD HEIGHT (mm)	C HEAD WIDTH (mm)	D GRIP LENGTH (mm)	PART NUMBER	THREAD SIZE (dia x pitch)	A BOLT LENGTH (mm)	B HEAD HEIGHT (mm)	C HEAD WIDTH (mm)	D GRIP LENGTH (mm)	PART NUMBER	
M6 x 1.00	12	4	10	2	8T-0639	M10 x 1.50	30	7	16	5	6V-1820	
	16	4	10	3	6V-8837		35	7	16	5	6V-3822	
	20	4	10	3	6V-8214		40	7	16	14	6V-5842	
	25	4	10	3	6V-8490		45	7	16	19	6V-5843	
	30	4	10	12	8T-0640		50	7	16	24	6V-4249	
	35	4	10	17	6V-2315		60	7	16	34	6V-5230	
	40	4	10	22	2W-9499		70	7	16	44	6V-7981	
	45	4	10	6	6V-7728		80	7	16	54	8T-0643	
	50	4	10	33	8T-0275		90	7	16	64	8T-0644	
	60	4	10	42	8T-5066		100	7	16	74	6V-1819	
	70	4	10	52	6V-8359		110	7	16	78	8T-0355	
	80	4	10	62	6V-9798		120	7	16	94	8T-5030	
	Nut						6V-8225	140	7	16	108	8C-2926
	Washer						9X-8267	150	7	16	118	8T-9085
M8 x 1.25	12	6	13	3	6V-2316	160	7	16	128	8T-0356		
	16	6	13	3	6V-5215	180	7	16	148	8T-7950		
	20	6	13	3	6V-5217	200	7	16	168	8T-6854		
	25	6	13	3	6V-3940	Nut					2Y-5829	
	30	6	13	8	6V-2317	Washer					6V-5839	
	35	6	13	13	6V-5218	M12 x 1.75	16	8	18	5	6V-8177	
	40	6	13	18	6V-5219		20	8	18	5	8T-0293	
	45	6	13	23	8T-0276		25	8	18	5	6A-5591	
	50	6	13	28	6V-3918		30	8	18	5	6V-3668	
	60	6	13	38	8T-0100		35	8	18	5	6V-8675	
	70	6	13	48	5P-8347		40	8	18	5	6V-8197	
	80	6	13	58	6V-5221		45	8	18	15	6V-5684	
	90	6	13	68	8T-0292		50	8	18	20	6V-7673	
	100	6	13	78	6V-5223		60	8	18	30	6V-3823	
	110	6	13	88	6V-3821		70	8	18	40	6V-8336	
	120	6	13	98	6V-9607		80	8	18	50	6V-5696	
	130	6	13	108	7X-0457		90	8	18	60	8T-0372	
	140	6	13	112	7X-0870		100	8	18	70	8T-0106	
150	6	13	122	8C-4984	110		8	18	80	8T-0646		
Nut					120	8	18	90	6V-8004			
Washer					140	8	18	104	7X-0909			
M10 x 1.50	12	7	16	5	6V-8084	150	8	18	114	8T-5044		
	16	7	16	3	6V-8212	160	8	18	124	8T-0162		
	20	7	16	5	6V-6317	180	8	18	144	8T-6991		
	25	7	16	5	6V-4248	200	8	18	147	8C-3226		

Hex Head Bolts / Metric / Coarse Thread UNC / Phosphate & Oil Coated

THREAD SIZE (dia x pitch)	A BOLT LENGTH (mm)	B HEAD HEIGHT (mm)	C HEAD WIDTH (mm)	D GRIP LENGTH (mm)	PART NUMBER
M12 x 1.75	Nut				6V-8149
	Washer				5P-8245
M14 x 2.00	20	9	21	6	8T-0373
	25	9	21	6	8T-0296
	30	9	21	6	8T-0297
	35	9	21	6	6V-8550
	45	9	21	6	8T-0226
	50	9	21	16	6V-5685
	60	9	21	26	8T-3666
	80	9	21	46	8T-3653
	90	9	21	56	8C-0537
	100	9	21	66	8T-0298
	Nut				139-6366
	M16 x 2.00	25	10	24	4
30		10	24	3	8T-0299
35		10	24	4	6V-5844
40		10	24	5	6V-4429
45		10	24	5	8T-0375
50		10	24	12	6V-5686
60		10	24	22	6V-3303
70		10	24	32	8T-0357
80		10	24	42	8T-0281
90		10	24	52	8T-0358
100		10	24	62	8T-0207
110		10	24	72	8T-0649
120		10	24	82	8T-0282
130		10	24	86	8T-0359
140		10	24	96	6V-7675
150		10	24	106	6V-8154
160		10	24	116	8T-0650
180		10	24	136	8T-5002
Nut					8T-1757
Washer					9X-8268
M20 x 2.50	30	13	30	4	8T-0651
	35	13	30	4	8T-0300
	40	13	30	5	6V-7729
	45	13	30	6	8T-0652
	50	13	30	4	6V-3531
	60	13	30	14	6V-3532
	70	13	30	24	6V-5845
	80	13	30	34	6V-3669
	90	13	30	44	8T-0360

THREAD SIZE (dia x pitch)	A BOLT LENGTH (mm)	B HEAD HEIGHT (mm)	C HEAD WIDTH (mm)	D GRIP LENGTH (mm)	PART NUMBER	
M20 x 2.50	100	13	30	54	6V-9667	
	110	13	30	64	8T-0362	
	120	13	30	74	8T-0070	
	130	13	30	78	8T-0655	
	140	13	30	88	6V-9167	
	150	13	30	98	8T-0656	
	160	13	30	108	8T-0657	
	180	13	30	128	8T-0658	
	200	13	30	148	6V-8569	
	Nut				6V-7742	
	Washer				8T-3282	
	M24 x 3.00	35	15	36	8	8T-0662
40		15	36	8	8T-0661	
45		15	36	8	8T-0663	
50		15	36	8	6V-9199	
70		15	36	8	8T-0664	
80		15	36	26	6V-8133	
90		15	36	36	8T-0666	
100		15	36	46	8T-0667	
110		15	36	56	8T-0668	
120		15	36	66	6V-8132	
130		15	36	70	8T-0669	
140		15	36	80	8T-0670	
150		15	36	90	8T-0671	
160		15	36	100	8T-0672	
180		15	36	120	8T-0674	
200		15	36	140	6V-8198	
Nut					7X-0851	
Washer					6V-8237	
M30 x 3.50		80	19	46	14	8C-3222
		90	19	46	24	8C-3411
	100	19	46	34	8T-0368	
	110	19	46	44	8T-0283	
	120	19	46	54	8T-0369	
	140	19	46	68	8T-0370	
	160	19	46	88	8C-3236	
	180	19	46	108	8T-6624	
	Nut				8T-1583	
	Washer				9X-8399	

Hardware

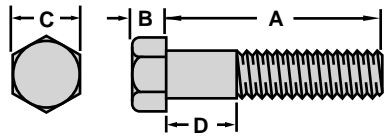

Hex Head Bolts / Metric / Coarse Thread UNC / Zinc Dichromate Plated

THREAD SIZE (dia x pitch)	A BOLT LENGTH (mm)	B HEAD HEIGHT (mm)	C HEAD WIDTH (mm)	D GRIP LENGTH (mm)	PART NUMBER	THREAD SIZE (dia x pitch)	A BOLT LENGTH (mm)	B HEAD HEIGHT (mm)	C HEAD WIDTH (mm)	D GRIP LENGTH (mm)	PART NUMBER	
M6 x 1.00	12	4	10	2	8T-4171	M10 x 1.50	25	7	16	5	8T-4136	
	16	4	10	3	5C-9553		30	7	16	5	8T-4195	
	20	4	10	3	8T-4138		35	7	16	5	8T-4196	
	25	4	10	2	6V-7357		40	7	16	14	8T-4186	
	30	4	10	12	8T-4971		45	7	16	19	8T-4182	
	35	4	10	17	7X-2533		50	7	16	24	8T-4185	
	40	4	10	22	8C-8451		60	7	16	34	8T-6466	
	45	4	10	6	8T-2947		70	7	16	44	8T-5005	
	50	4	10	32	7X-2534		80	7	16	54	8T-4172	
	60	4	10	42	7X-2535		90	7	16	64	8T-4178	
	70	4	10	52	8T-3844		100	7	16	74	8T-4198	
	80	4	10	62	8T-6974		110	7	16	84	8T-6685	
	Nut						5C-2890	120	7	16	94	7X-2543
	Washer						9X-8256	130	7	16	98	8T-5436
M8 x 1.25	12	6	13	3	8T-4199		140	7	16	108	7X-2544	
	16	6	13	3	8T-4200		150	7	16	118	7X-2545	
	20	6	13	3	8T-4189		160	7	16	128	8T-6408	
	25	6	13	3	8T-4908		180	7	16	148	7X-2546	
	30	6	13	8	8T-7547		200	7	16	168	7X-2547	
	35	6	13	13	7X-2537		Nut					8T-4133
	40	6	13	3	8T-4197	Washer					8T-4121	
	45	6	13	23	7X-0818	M12 x 1.75	16	8	18	5	7X-2548	
	50	6	13	28	8T-6912		20	8	18	5	8T-4179	
	60	6	13	38	8T-6869		25	8	18	5	8T-4192	
	70	6	13	48	8T-6870		30	8	18	5	8T-4139	
	80	6	13	58	8T-3647		35	8	18	5	8T-4956	
	90	6	13	68	8T-4177		40	8	18	5	8T-4183	
	100	6	13	78	7X-2538		45	8	18	15	8T-4184	
	110	6	13	88	7X-2539		50	8	18	20	8T-4194	
	120	6	13	98	7X-2540		60	8	18	30	8T-4910	
	130	6	13	108	108-2989		70	8	18	40	8T-4648	
	140	6	13	112	7X-2541		80	8	18	50	8T-6868	
	150	6	13	122	7X-2542		90	8	18	60	8T-4176	
	160	6	13	128	8T-7352		100	8	18	70	7X-2549	
Nut					110		8	18	80	7X-2550		
Washer					120	8	18	90	8T-5041			
M10 x 1.50	12	7	16	5	7X-2621	130	8	18	94	8T-5001		
	16	7	16	5	8T-4191	140	8	18	104	8T-5412		
	20	7	16	5	8T-4137	150	8	18	114	8T-5092		

Hex Head Bolts / Metric / Coarse Thread UNC / Zinc Dichromate Plated

THREAD SIZE (dia x pitch)	A BOLT LENGTH (mm)	B HEAD HEIGHT (mm)	C HEAD WIDTH (mm)	D GRIP LENGTH (mm)	PART NUMBER	THREAD SIZE (dia x pitch)	A BOLT LENGTH (mm)	B HEAD HEIGHT (mm)	C HEAD WIDTH (mm)	D GRIP LENGTH (mm)	PART NUMBER
M12 x 1.75	160	8	18	124	8T-7930	M20 x 2.50	180	13	30	128	7X-2568
	180	8	18	144	8T-7929		200	13	30	148	7X-2569
	200	8	18	147	7X-2551		Nut				8T-4131
	Nut				8T-4244		Washer				8T-4123
	Washer				8T-4223	M24 x 3.00	35	15	36	8	7X-2572
M16 x 2.00	25	10	24	4	8T-4190		40	15	36	8	7X-2573
	30	10	24	3	7X-2552		45	15	36	8	7X-2574
	35	10	24	4	8T-4779		50	15	36	8	8T-5379
	40	10	24	5	7X-2553		60	15	36	8	7X-2575
	45	10	24	5	8T-7338		70	15	36	8	7X-2576
	50	10	24	12	8T-4193		80	15	36	26	8T-5878
	60	10	24	22	8T-4140		90	15	36	36	7X-2577
	70	10	24	32	7X-2554		100	15	36	46	7X-2489
	80	10	24	42	7X-2555		110	15	36	56	7X-2454
	90	10	24	52	8T-4175		120	15	36	66	8T-0363
	100	10	24	56	7X-2556		130	15	36	70	8T-6380
	110	10	24	72	8T-4173		140	15	36	80	8T-4649
	120	10	24	82	8T-4174		150	15	36	90	8C-3290
	130	10	24	86	7X-2475		160	15	36	100	7X-2567
	140	10	24	96	7X-2557		180	15	36	120	7X-2465
	150	10	24	106	7X-2558		200	15	36	140	7X-2578
	160	10	24	116	7X-2559		Nut				8T-4001
	180	10	24	136	8T-6385		Washer				8T-4167
	200	10	24	156	8T-6383		M30 x 3.50	50	19	46	9
	Nut				8T-4132	80		19	46	14	8C-8723
Washer				8T-4122	90	19		46	24	7X-2580	
M20 x 2.50	30	13	30	4	8T-4780	100		19	46	34	7X-2581
	35	13	30	4	7X-2561	110		19	46	44	7X-2582
	40	13	30	5	8T-5460	120		19	46	54	7X-2583
	45	13	30	6	7X-2562	140		19	46	68	7X-2584
	50	13	30	4	8T-6430	160		19	46	88	7X-2585
	60	13	30	14	7X-2563	180		19	46	108	7X-2586
	70	13	30	24	8T-4141	Nut					8C-8722
	80	13	30	34	8T-4187	Washer				9X-8258	
	90	13	30	44	7X-2564						
	100	30	30	54	7X-2565						
	110	13	30	64	7X-2566						
	120	13	30	74	8T-6381						
	130	13	30	78	7X-2532						
	140	13	30	88	8C-8478						
	150	13	30	98	8T-4170						
	160	13	30	108	7X-2488						

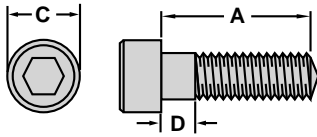

Hex Socket Head Screw Bolts / Metric / Coarse Thread UNC

THREAD SIZE (dia x pitch)	A BOLT LENGTH (mm)	C HEAD WIDTH (mm)	D GRIP LENGTH (mm)	PART NUMBER
M3 x 0.50	6	6	2	8C-6365
	20	6	2	8T-9006
M4 x 0.70	6	7	2	095-0640
	10	7	2	095-0641
	16	7	1	8T-9405
	20	7	1	8C-4982
	45	7	25	101-4306
	65	7	51	107-3198
M5 x 0.80	8	9	2	096-5968
	10	9	2	099-0822
	12	9	2	099-2374
	14	9	2	8C-6364
	16	9	2	8C-8580
	20	9	2	096-4833
	25	9	2	096-5969
	35	9	13	8T-6699
	40	9	18	8T-0266
	45	9	23	8T-3283
	50	9	28	095-0642
M6 x 1.00	10	10	5	9X-6153
	12	10	3	8T-0267
	16	10	3	6V-5683
	20	10	3	8T-0269
	25	10	3	3T-0849
	30	10	3	8T-8442
	35	10	11	1R-5396
	40	10	16	6V-8653
	45	10	21	8C-6965
	50	10	32	8T-9534
	55	10	37	095-0645
	60	10	36	8T-2396
	65	10	41	8T-2922
	70	10	46	9X-2537
M8 x 1.25	16	13	4	6V-8202
	20	13	4	8T-1158
	25	13	4	5A-3604

THREAD SIZE (dia x pitch)	A BOLT LENGTH (mm)	C HEAD WIDTH (mm)	D GRIP LENGTH (mm)	PART NUMBER
M8 x 1.25	30	13	4	6V-5192
	35	13	4	6V-8337
	45	13	17	8T-0338
	50	13	22	3E-8025
	55	13	33	9X-6154
	60	13	38	8T-9535
	65	13	37	096-0187
	70	13	42	6V-8213
	80	13	58	6V-5196
	90	13	62	8T-2394
	100	13	72	102-7365
	110	13	82	8T-0339
	130	13	102	3E-8006
	200	13	172	9X-8269
M10 x 1.50	16	16	5	096-4835
	20	16	5	6V-3938
	25	16	5	8T-1159
	30	16	3	9X-6032
	35	16	5	8T-0271
	40	16	8	8T-9515
	45	16	13	8T-2223
	50	16	18	8T-1160
	55	16	29	095-0655
	60	16	28	8T-0341
	65	16	33	8T-2392
	70	16	38	095-0658
	80	16	48	8T-0342
	90	16	58	9X-2158
	100	16	68	8T-7586
	110	16	78	8T-0272
	120	16	88	096-1331
130	16	98	086-2369	
150	16	118	3E-8028	
220	16	194	095-0665	
M12 x 1.75	20	18	5	8T-9080
	25	18	5	8T-8441
	30	18	5	8T-3957
	35	18	5	6V-8200
	40	18	5	8T-0273

Hex Socket Head Screw Bolts / Metric / Coarse Thread UNC

THREAD SIZE (dia x pitch)	A BOLT LENGTH (mm)	C HEAD WIDTH (mm)	D GRIP LENGTH (mm)	PART NUMBER
M12 x 1.75	45	18	5	095-0670
	50	18	5	8T-7811
	55	18	19	8T-0343
	60	18	24	095-0673
	65	18	35	095-0674
	70	18	34	3E-6910
	80	18	44	8C-8729
	90	18	54	3E-8007
	100	18	64	7X-2436
	110	18	74	095-9804
	120	18	84	8C-3413
	130	18	94	7X-2607
	140	18	104	8T-7058
	180	18	144	3E-6911
	220	18	184	8C-4980
M16 x 2.00	25	24	6	3E-6923
	30	24	6	8T-0439
	35	24	6	8T-6594
	40	24	6	8T-4944
	45	24	6	6V-8201
	50	24	6	8T-0348
	55	24	17	095-0700
	60	24	6	8T-2393
	65	24	21	8T-0349
	70	24	26	8T-1447
	80	24	36	095-9806
	90	24	46	3E-8008
	100	24	56	095-0705
	110	24	66	095-0706
	120	24	76	095-0707
	140	24	96	096-0008
	160	24	116	8C-7587
180	24	136	102-2562	
200	24	156	7Y-5243	
260	24	216	7Y-5244	
M20 x 2.50	45	30	8	7Y-5221
	50	30	8	8T-5042
	55	30	8	8T-6593
	60	30	8	7Y-5241
	70	30	8	7Y-5217

THREAD SIZE (dia x pitch)	A BOLT LENGTH (mm)	C HEAD WIDTH (mm)	D GRIP LENGTH (mm)	PART NUMBER
M20 x 2.50	80	30	28	7Y-5216
	90	30	38	9X-2404
	150	30	98	113-7430
	240	30	196	102-2563
	300	30	256	102-2564
M24 x 3.00	90	36	30	7Y-5215
	100	36	40	7Y-5239
	110	36	50	9X-8480
	130	36	70	9X-8915

Hardware

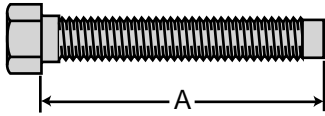

Forcing Bolts / Inch / Fine Thread UNF

THREAD SIZE (in - TPI)	A LENGTH (in)	GRIP LENGTH (in)	PART NUMBER
7/8-14	5 3/8	0.33	5P-5265
1-14	6 15/16	0.97	5P-8715
1 1/2-12	2 7/8	0.33	6V-0187
1 1/2-12	4 3/4	0.33	5P-5264

Forcing Bolts / Metric / Coarse Thread UNC

THREAD SIZE (dia x pitch)	A LENGTH (mm)	GRIP LENGTH (mm)	PART NUMBER
M24 x 3.0	190	13	136-1978

Track Bolts / Inch

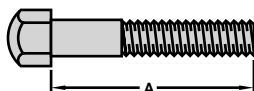

MODEL	THREAD SIZE (in - TPI)	A BOLT LENGTH In.	PART NUMBER
307, E70, E70B	1/2 - 20	1.38	102-8072
307, PM465	1/2 - 20	1.50	3A-9605
D3, D4, 931	1/2 - 20	1.50	8H-7504
931C, 933C, 935C, 941 D3, D4, D4B, D4C, 215 TR225B, AP1050 PR450, SF350	9/16 - 18	1.63	4K 7038
AP650B, BG225C, AP1050B, BG245C	9/16 - 18	2.00	8S4745
D5C *, 561, D4, D5, D6 941, 943, 951, 953, 955, 977, 205, 211, 213, 215, 215SA, 219, 225 PR750, PR1000, PM565 SF500, TR500	5/8 - 18	2.01	7H-3597
D5M, D5C, D5H, D4H 939, 939C	5/8 - 18	2.17	9G3110
D6, D7, 572 955, 963, 977 215SA, 219, 225, 225SA 229, 231, 235, FB227	3/4 - 16	2.16	1S-1859

* Use with "9K" links

MODEL	THREAD SIZE (in - TPI)	A BOLT LENGTH In.	PART NUMBER
D7, D8, 571, 572 973, 977, 235, 583	3/4 - 16	2.41	7H-3598
D7H, D6R, D6H, D6M, D5H 517, 527, FB227, D6HD	3/4 - 16	2.40	6V1792
D7R, D7H, D8 973, 983, 235	7/8 - 14	2.66	7H3599
D8R/N, D8L, 583R, 578	7/8 - 14	3.43	6V1723
235	7/8 - 14	2.80	5P4028
D9, 594, 245**	1 - 14	2.94	2M-5657
245	1 - 14	3.11	3T-6308
D9R/N	1 - 14	3.54	6T-2638
D9L, 589	1 - 14	3.81	6V-1726
D10	1 1/8 - 12	4.21	5P-3868
D10R/N	1 1/8 - 12	3.78	7T-1000
5130	1 3/8 - 12	4.73	6I-8648
D11RN, 5130	1 3/8 - 12	4.30	6T-8853

** Use with "8K" links

Track Bolts / Inch / Self Cleaning Shoes

MODEL	THREAD SIZE (in - TPI)	A BOLT LENGTH In.	PART NUMBER
D3C, D4C, D4	9/16 - 18	1.62	4K-7038
	9/16 - 18	3.00	5A-3187
D5H, D5M, D4H	5/8 - 18	2.17	9G3110
	5/8 - 18	3.54	3T-3884
D4, D5	5/8 - 18	3.31	5A-4104
	5/8 - 18	2.01	7H-3597
D6M/D5H	3/4 - 16	3.62	107-0718
	3/4 - 16	2.40	6V1792
D7H, D6R, D6H	3/4 - 16	4.13	6T2162
	3/4 - 16	2.40	6V1792

MODEL	THREAD SIZE (in - TPI)	A BOLT LENGTH In.	PART NUMBER
D6	3/4 - 16	2.16	1S1859
	3/4 - 16	3.90	5A-7524
D7	3/4 - 16	4.10	5P-1028
	3/4 - 16	2.41	7H-3598
D7R/H	7/8 - 14	2.66	7H3599
	7/8 - 14	4.33	116-8145

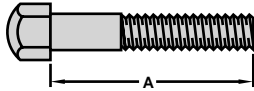

Track Bolts / Metric

MODEL	THREAD SIZE (dia x pitch)	A BOLT LENGTH MM	PART NUMBER
307B	M14 x 1.50	35	136-2401
311, 312, 313 E110, E110B, E120, E120B	M16 x 1.50	46	4I-7538
E140	M16 x 1.50	55	096-1043
E180	M18 x 1.50	58	093-0262
315, 317, 318, 320, 322, E200B, E240B, E240C	M20 x 1.50	55	9W-3619
317, 318, 320, 320S, 322, 325	M20 x 1.50	63	6Y-0846
E240, E300	M20 x 1.50	63	093-0266
E300B, EL300	M20 x 1.50	70	093-0265
330, 345, 350	M22 x 1.50	67	6Y-9024
350	M22 x 1.50	73	143-4891
E450	M22 x 1.50	78	093-0268
E650	M24 x 1.50	81	093-0271
345B	M24 x 1.50	67	150-4741
365B	M27 x 2.00	78	144-0805
375, 5080	M27 x 2.00	90	6Y-7432

Track Bolts / Metric / Self Cleaning Shoes

MODEL	THREAD SIZE (dia x pitch)	A BOLT LENGTH MM	PART NUMBER
311, 312, 313 E110, E110B, E120, E120B, E140	M16 x 1.50	108	093-0261
	M16 x 1.50	68	093-0259
E180*	M18 x 1.50	90	093-0264
315, 317, 318, 320, 322 E200B, E240B, E240C	M20 x 1.50	55	9W-3619
	M20 x 1.50	80	8E-9349
E240*	M20 x 1.50	108	096-0551
325	M20 x 1.50	63	6Y-0846
	M20 x 1.50	110	6Y-5686
330	M22 x 1.50	67	6Y-0924
	M22 x 1.50	110	5Q-3253

* Only one bolt length used.

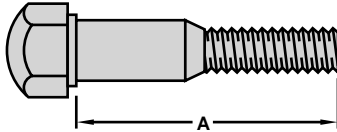

Split Master Link Bolts / Inch

MODEL	THREAD SIZE (in - TPI)	A BOLT LENGTH In.	PART NUMBER
D3, D3C, D4C 935C, 933C, 931C PM465, AP1050, PR450 SF350, TR225B	9/16 - 18	3.00	5A-3187
AP650B, BG225C AP1050B, BG245C	9/16 - 18	3.50	8S4747
D5M, D4H, D5H D5C, 939C	5/8 - 18	2.64	3T8601
D5M, D4H, D5C, 939C	5/8 - 18	3.27	9G-8592
D5H	5/8 - 18	3.58	3T-8580
D5C*, D4, D5, D6, 561 941, 943, 951, 953, 955, 977	5/8 - 18	3.50	3P-2274
D6M, D5H, 517	3/4 - 16	3.90	107-0719
D6M, D5H, 517	3/4 - 16	2.91	106-1642
D7H	3/4 - 16	3.15	6V-1793
D7H, D6, 963, 955	3/4 - 16	4.13	9S-1838

MODEL	THREAD SIZE (in - TPI)	A BOLT LENGTH In.	PART NUMBER
D7, 571, 572 973, 977	3/4 - 16	4.45	2P-9670
D7R/H, 973	7/8 - 14	4.57	9W-9058
D7R/H	7/8 - 14	3.43	6V-1723
D8R/N, D8L, 583R, 578	7/8 - 14	3.78	6V-1724
D8R/N, D8L, 583R, 578	7/8 - 14	5.08	6V-1725
D8, 983, 583	7/8 - 14	4.84	8S-0395
D9R/N, D9L, 589	1 - 14	5.83	6V-1728
D9R/N, D9L, 589	1 - 14	4.84	7T-2283
D9, 594	1 - 14	5.56	8S-1723
D10R/N	1 1/8 - 12	6.46	7T-0998
D10R/N	1 1/8 - 12	5.28	7T-0999
D10	1 1/8 - 12	6.61	5P-8222
D11R/N	1 3/8 - 12	7.20	6T-8520
D11R/N	1 3/8 - 12	6.02	6T-8521

* Use with "9K" links.

Split Master Link Bolts / Inch / Self Cleaning Shoes

MODEL	THREAD SIZE (in - TPI)	A BOLT LENGTH In.	PART NUMBER
D3C, D4C	9/16 - 18	4.29	5P-4683
	9/16 - 18	3.00	5A-3187
D5M, D4H	5/8 - 18	3.27	9G-8592
	5/8 - 18	4.02	3T-3889
D5H	5/8 - 18	3.58	3T-8580
	5/8 - 18	4.02	3T-3889
D4, D5	5/8 - 18	3.50	3P-2274
	5/8 - 18	4.63	5P0569

MODEL	THREAD SIZE (in - TPI)	A BOLT LENGTH In.	PART NUMBER
D6M, D5H	3/4 - 16	3.90	107-0719
	3/4 - 16	4.29	107-0717
D6R/H, D6	3/4 - 16	5.47	3P-1111
	3/4 - 16	4.13	9S-1838
D7	3/4 - 16	4.29	2P-9670
	3/4 - 16	5.47	3P-1111
D7H	3/4 - 16	4.29	2P-9670
	3/4 - 16	4.92	6T-1441
D7R/H	7/8 - 14	4.57	9W-9058
	7/8 - 14	5.08	6V-1725

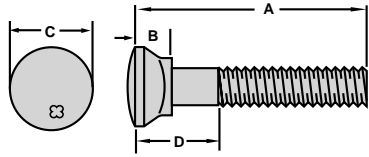

Cutting Edge Bolts / Inch / Coarse Thread

THREAD SIZE (in - TPI)	A BOLT LENGTH (in)	B HEAD HEIGHT (in)	C HEAD WIDTH (in)	D GRIP LENGTH (in)	PART NUMBER
3/8-16	2	0.31	0.67	1.00	4F-4048
	Nut				6B-6682
1/2-13	1 1/4	0.44	0.89	0.50	4F-3647
	1 1/2	0.44	0.89	0.63	4F-3646
	1 3/4	0.44	0.89	0.63	4F-3648
	2	0.44	0.89	0.75	4F-3649
	2 1/4	0.44	0.89	1.00	4F-3650
	2 1/2	0.44	0.89	1.25	4F-3651
	2 3/4	0.44	0.89	1.50	4F-3652
	3	0.44	0.89	1.75	4F-3662
	3 1/2	0.45	0.89	2.25	4F-3663
	5	0.44	0.89	3.75	4F-4043
	Nut				10-4719
	5/8-11	1 1/2	0.54	1.04	0.63
1 3/4		0.54	1.04	0.63	4F-3653
2		0.54	1.04	0.75	4F-3654
2 1/4		0.54	1.04	1.25	3F-5108
2 1/2		0.54	1.04	1.00	4F-3656
2 3/4		0.54	1.04	1.25	4F-3657
3		0.54	1.04	1.50	4F-3658
3 1/2		0.54	1.04	2.00	4F-3665
3 3/4		0.54	1.04	2.25	4F-0391
4		0.54	1.04	2.50	4F-3671
Nut					4K-0367
3/4-10	2	0.63	1.20	0.75	4F-3672
	2 1/4	0.63	1.20	1.00	4F-7827
	2 1/2	0.63	1.20	1.19	5J-4773
	2 3/4	—	—	1.50	5J-4771
	3 1/8	0.63	1.20	1.38	1J-6762
	3 3/4	0.63	1.20	2.00	5F-8933
	4 1/4	0.63	1.20	2.50	1J-0962
	4 5/8	0.63	1.20	2.88	1J-6761
	Nut				2J-3506
7/8-9	2 1/2	0.74	1.41	1.36	5J-4772
	2 3/4	0.74	1.41	1.50	6F-0196
	3	0.74	1.41	1.25	5J-2409
	3 1/4	0.74	1.41	2.44	8J-2935
	3 1/2	0.74	1.41	1.75	2J-2548
	4 1/4	0.74	1.41	2.50	2J-5458

THREAD SIZE (in - TPI)	A BOLT LENGTH (in)	B HEAD HEIGHT (in)	C HEAD WIDTH (in)	D GRIP LENGTH (in)	PART NUMBER
7/8-9	4 5/8	0.74	1.41	2.63	1J-0849
	Nut				2J-3505
1-8	2 1/2	0.81	1.60	1.31	3J-2801
	2 3/4	0.81	1.60	1.50	1J-5607
	3	0.81	1.60	1.75	4F-4042
	3 1/4	0.81	1.60	1.91	4J-9058
	3 1/2	0.81	1.60	2.19	4J-9208
	3 3/4	0.81	1.60	2.69	8J-2928
	3 3/4	0.81	1.60	1.50	1J-4948
	4	0.81	1.60	2.95	5P-8136
	4 1/2	0.81	1.60	2.25	1J-3527
	5 1/4	0.81	1.60	3.00	1J-4947
	Nut				2J-3507
	1 1/4-7	3 3/8	1.06	2.03	1.65
3 3/4		1.06	2.03	2.28	6V-6535
4 1/8		1.02	2.01	2.28	5P-8823
4 1/2		1.06	2.03	2.28	6V-8360
4 15/16		1.06	2.03	2.28	5P-8361
Nut					3K-9770

Maintenance Tips For Cutting Edge Hardware

1. Clean all surfaces of rust, paint, nicks, and burrs.
2. Install bolts first in the center and work out toward the edge.
3. Tighten all bolts to the specified torque (see chart below for specifications).
4. Set bolt heads firmly into the edge countersink using a heavy hammer. Safety glasses **MUST** be worn when striking bolt heads.
5. Tighten all bolts again to the specified torque.

THREAD SIZE (in - TPI)	(ft lbs)	TORQUE (N•M)	Size
5/8	200 ±30	270 ±40	16 mm
3/4	350 ±45	475 ±60	19 mm
7/8	550 ±65	750 ±90	22 mm
1	825 ±110	1125 ±150	25 mm
1 1/4	1350 ±220	1850 ±300	32 mm

Hardware

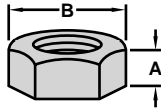

Nuts / Hex Head / Inch

- Made of fine grain steel.
- Designed with a washer-faced surface.
- Provide a tensile strength comparable to SAE Grade 8 bolt.
- Hardened nuts marked with 6 lines, dashes, or dots for identification.

Coarse Thread UNC / Phosphate & Oil Coated / Hardened

THREAD SIZE (in - TPI)	A NUT HEIGHT (in)	B NUT WIDTH (in)	PART NUMBER
1/4-20	0.22	7/16	9S-8750
5/16-18	0.27	1/2	5S-0003
3/8-16	0.39	9/16	9S-8752
7/16-14	0.38	11/16	3S-1546
1/2-13	0.44	3/4	1F-7958
9/16-12	0.48	7/8	5P-0539
5/8-11	0.55	15/16	4K-0367

THREAD SIZE (in - TPI)	A NUT HEIGHT (in)	B NUT WIDTH (in)	PART NUMBER
3/4-10	0.64	1 1/8	2J-3506
7/8-9	0.75	1 5/16	2J-3505
1-8	0.86	1 1/2	2J-3507
1 1/8-7	0.97	1 11/16	4J-5977
1 1/4-7	1.06	1 7/8	3K-9770
1 3/8-6	1.17	2 1/16	9M-3770
1 1/2-6	1.28	2 1/4	9S-8216

Coarse Thread UNC / Zinc Dichromate Plated / Hardened

THREAD SIZE (in - TPI)	A NUT HEIGHT (in)	B NUT WIDTH (in)	PART NUMBER
1/4-20	0.22	7/16	6V-8185
5/16-18	0.27	1/2	6V-8189
3/8-16	0.33	9/16	6V-8801
7/16-14	0.37	11/16	7X-0447
1/2-13	0.44	3/4	6V-8188
5/8-11	0.55	15/16	7X-0448

THREAD SIZE (in - TPI)	A NUT HEIGHT (in)	B NUT WIDTH (in)	PART NUMBER
3/4-10	0.64	1 1/8	6V-8182
7/8-9	0.75	1 5/16	7X-0449
1-8	0.86	1 1/2	6V-8190
1 1/8-7	0.97	1 11/16	7X-0450
1 1/4-7	1.06	1 7/8	7X-0451
1 1/2-6	1.28	2 1/4	7X-0452

Fine Thread UNF / Phosphate & Oil Coated / Hardened

THREAD SIZE (in - TPI)	A NUT HEIGHT (in)	B NUT WIDTH (in)	PART NUMBER
1/4-28	0.22	7/16	9S-8748
5/16-24	0.27	1/2	9S-8751
3/8-24	0.39	9/16	3S-2713
7/16-20	0.38	11/16	9S-8905
1/2-20	0.44	3/4	6B-6684
9/16-18	0.48	7/8	5P-0540
5/8-18	0.55	15/16	6B-6683

THREAD SIZE (in - TPI)	A NUT HEIGHT (in)	B NUT WIDTH (in)	PART NUMBER
3/4-16	0.64	1 1/8	6B-6682
7/8-14	0.75	1 5/16	1A-5666
1-14	0.86	1 1/2	1A-1935
1 1/8-12	.97	1 11/16	3S-1356
1 1/4-12	1.06	1 7/8	7H-7539
1 3/8-12	1.17	2	2M-0400
1 1/2-12	1.28	1 9/32	8H-3390

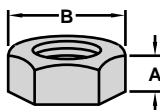

Self-Locking Nuts / Hex Head / Inch

- Made of fine grain steel.
- Resist loosening under vibration.
- Provide a tensile strength comparable with SAE Grade 8 bolts.
- Resist loosening under vibration.

Coarse Thread UNC / Hardened

THREAD SIZE (in - TPI)	A NUT HEIGHT (in)	B NUT WIDTH (in)	PART NUMBER
1/4-20	0.23	7/16	2D-6235
5/16-18	0.27	1/2	031-4155
3/8-16	0.33	9/16	2K-4973
7/16-14	0.38	11/16	6V-5729
1/2-13	0.44	3/4	1K-6872
9/16-12	0.50	7/8	034-9954

THREAD SIZE (in - TPI)	A NUT HEIGHT (in)	B NUT WIDTH (in)	PART NUMBER
5/8-11	0.55	15/16	3K-2889
3/4-10	0.64	1 1/8	1K-6870
7/8-9	0.75	1 5/16	6K-0545
1-8	0.86	1 1/2	6K-3632
1 1/8-7	0.97	1 11/16	8D-9513
1 1/4-7	1.06	1 7/8	2J-5997

Fine Thread / UNF / Hardened

THREAD SIZE (in - TPI)	A NUT HEIGHT (in)	B NUT WIDTH (in)	PART NUMBER
1/4-28	0.23	7/16	2L-9038
5/16-24	0.27	1/2	3D-8752
1/2-20	0.44	3/4	2K-0564
9/16-18	0.50	7/8	054-5448
5/8-18	0.55	15/16	2K-4821

THREAD SIZE (in - TPI)	A NUT HEIGHT (in)	B NUT WIDTH (in)	PART NUMBER
3/4-16	0.64	1 1/8	2K-0337
7/8-14	0.75	1 5/16	5D-1986
1-14	0.86	1 1/2	2K-7471
1 1/8-12	0.97	1 11/16	3D-4904
1 1/4-12	1.06	1 7/8	2K-7468
1 1/2-12	1.28	2 1/4	5M-6667

Hardware

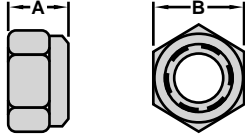

Self-Locking Nuts / Hex Head / Inch / Plastic Insert

- Resist loosening under vibration.

Coarse Thread / UNC / Zinc Dichromate Plated / Hardened

THREAD SIZE (in - TPI)	A NUT HEIGHT (in)	B NUT WIDTH (in)	PART NUMBER
1/4-20	0.31	7/16	3E-9865
5/16-18	0.34	1/2	3E-9860
3/8-16	0.45	9/16	3K-6060
1/2-13	0.59	3/4	9X-0941
5/8-11	0.75	15/16	3E-9861
3/4-10	0.88	1 1/16	3E-9862
7/8-9	0.98	1 1/4	3E-9863

Coarse Thread UNC / Zinc Dichromate Plated / Non Hardened

THREAD SIZE (in - TPI)	A NUT HEIGHT (in)	B NUT WIDTH (in)	PART NUMBER
No. 6-32	0.18	5/16	7D-6922
No. 8-32	0.23	11/32	6D-5801
No. 10-24	0.25	3/8	031-0249
1/4-20	0.31	7/16	7H-8909
5/16-18	0.34	1/2	2R-0504

THREAD SIZE (in - TPI)	A NUT HEIGHT (in)	B NUT WIDTH (in)	PART NUMBER
3/8-16	0.37	11/16	9T-2730
1/2-13	0.59	3/4	2H-3788
5/8-11	0.75	15/16	2H-3789
3/4-10	0.88	1 1/16	2H-3790

Fine Thread UNF / Zinc Dichromate Plated / Non Hardened

THREAD SIZE (in - TPI)	A NUT HEIGHT (in)	B NUT WIDTH (in)	PART NUMBER
No. 10-32	0.25	3/8	4L-1250
1/4-28	0.31	7/16	3F-7674
5/16-24	0.34	1/2	3F-2617
3/8-24	0.18	9/16	2F-8616

THREAD SIZE (in - TPI)	A NUT HEIGHT (in)	B NUT WIDTH (in)	PART NUMBER
7/16-20	0.45	11/16	139-4187
1/2-20	0.59	3/4	2M-2570

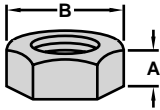

Hex Jam Nuts / Hex Head / Inch

- Designed with a chamfered and washer-faced surface.
- For use in locking other nuts to prevent loosening.

Coarse Thread UNC / Non Hardened

THREAD SIZE (in - TPI)	A NUT HEIGHT (in)	B NUT WIDTH (in)	PART NUMBER
1/4-20	0.16	7/16	1B-4427
5/16-18	0.19	1/2	5B-3180
3/8-16	0.22	9/16	1B-2578
7/16-14	0.25	11/16	1L-9048
1/2-13	0.31	3/4	3H-3680
9/16-12	0.31	7/8	8S-5151

THREAD SIZE (in - TPI)	A NUT HEIGHT (in)	B NUT WIDTH (in)	PART NUMBER
5/8-11	0.38	15/16	1D-5118
3/4-10	0.42	1 1/8	1D-5119
7/8-9	0.48	1 5/16	5P-0541
1-8	0.55	1 1/2	1D-6306

Fine Thread UNF / Non Hardened

THREAD SIZE (in - TPI)	A NUT HEIGHT (in)	B NUT WIDTH (in)	PART NUMBER
1/4-28	0.16	7/16	9M-1311
5/16-24	0.19	1/2	4F-2294
3/8-24	0.22	9/16	2A-5351
7/16-20	0.25	11/16	5B-3254
3/4-16	0.42	1 1/8	1D-5120

THREAD SIZE (in - TPI)	A NUT HEIGHT (in)	B NUT WIDTH (in)	PART NUMBER
7/8-14	0.48	1 5/16	1D-5121
1-14	0.55	1 1/2	2H-3786

Hardware

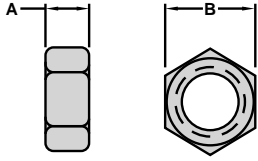

Nuts / Hex Head / Metric

- Made of fine grain steel.
- Designed with a washer-faced surface.
- Provide a proof load comparable to 10.9 metric bolt.

Coarse Thread UNC / Phosphate & Oil Coated / Hardened

THREAD SIZE (dia x pitch)	A NUT HEIGHT (mm)	B NUT WIDTH (mm)	PART NUMBER
M6 x 1.00	5.05	10	6V-8225
M8 x 1.25	6.40	13	5P-7970
M10 x 1.50	8.22	16	2Y-5829
M12 x 1.75	10.64	18	6V-8149
M16 x 2.00	14.45	24	8T-1757
M20 x 2.50	18.00	30	6V-7742

THREAD SIZE (dia x pitch)	A NUT HEIGHT (mm)	B NUT WIDTH (mm)	PART NUMBER
M24 x 3.00	21.50	36	7X-0851
M30 x 3.50	24.95	46	8T-1583

Coarse Thread UNC / Zinc Dichromate Plated / Hardened

THREAD SIZE (dia x pitch)	A NUT HEIGHT (mm)	B NUT WIDTH (mm)	PART NUMBER
M6 x 1.00	5.05	10	5C-2890
M8 x 1.25	6.40	13	5C-7261
M10 x 1.50	8.22	16	8T-4133
M12 x 1.75	10.64	18	8T-4244
M16 x 2.00	14.45	24	8T-4132

THREAD SIZE (dia x pitch)	A NUT HEIGHT (mm)	B NUT WIDTH (mm)	PART NUMBER
M20 x 2.50	18.00	30	8T-4131
M24 x 3.00	21.50	36	8T-4001
M30 x 3.50	24.95	46	8C-8722

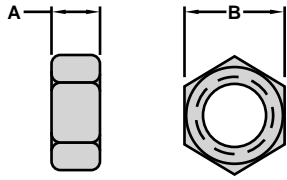

Self-Locking Nuts / Hex Head / Metric Coarse Thread UNC / Hardened

- Made of fine grain steel.
- Designed with a washer-faced surface.
- Provide a proof load comparable to 10.9 metric bolt.
- Resist loosening under vibration.

THREAD SIZE (dia x pitch)	A HEIGHT (mm)	B WIDTH (mm)	PART NUMBER
M6 x 1.00	5.90	10	6V-7743
M8 x 1.25	7.10	13	6V-9189
M10 x 1.50	9.00	16	6V-7744
M12 x 1.75	11.60	18	6V-7687
M16 x 2.00	15.20	24	8T-4778
M20 x 2.50	22.15	30	6V-7688
M24 x 3.00	26.35	36	6V-7676
M30 x 3.50	30.00	46	8T-5065

Track Nuts



Inch



Metric

MODEL	THREAD SIZE (in - TPI)	A NUT HEIGHT In.	PART NUMBER
D3, 931	1/2 - 20	0.60	6S-3419
D4	1/2 - 20	0.56	8H-5724
307, PM465	1/2 - 20	0.63	117-8885
307, E70, E70B	1/2 - 20	0.51	102-8073
D3, D3B, D3C, D4, D4B, D4C, 215, 931, 933, 935, 941 PR450, PM 565, AP650B, AP1050, BG225C, BG245C SF350, TR225B,	9/16 - 18	0.72	7K-2017
D4, 941	9/16 - 18	0.61	7H-3606
D4, D5C, D5, D6, 561 939, 941, 943, 951 953, 955, 977 205, 211, 213, 215, 215SA, 219, 225 PR750, PR1000, SF500, TR500	5/8 - 18	0.72	1M-1408
D6M, D5H, D6R/H, D7H, 517, 527, D6, D7, D8, 955, 936, 973, 977 571, 572, 583 215SA, 219, 225, 225SA, FB227, 229, 231, 235	3/4 - 16	0.74	1S-1860
973, 235	7/8 - 14	0.94	7T-9825
D7R/H D8, 983, 583	7/8 - 14	0.93	2S-2140
D9, 594, 245	1 - 14	1.00	1S-6421
245 *	1 - 14	1.00	2V-0250

* Use with "8K" links.

MODEL	THREAD SIZE (dia x pitch)	A NUT HEIGHT MM	PART NUMBER
307B	M14 x 1.50	14	136-2404
311, 312, 313E110, E110B, E120B, E120	M16 x 1.50	16	5I-6125
E140	M16 x 1.50	22	093-0319
E180, EL180	M18 x 1.50	22	093-0320
315, 317, 318, 320, 322, 325, 3205, E200B, EL200B, E240B, EL240B, E240C, EL240C	M20 x 1.50	21	9W-3361
E240, EL240, E300B, E300, EL300, EL300B	M20 x 1.50	27	093-0321
330, 345, 350	M22 x 1.50	22	9W-4381
E450	M22 x 1.50	29	096-0586
345B	M24 x 1.50	24	150-4742
E650	M24 x 1.50	29	093-0323
365B	M27 x 2.00	27	144-0806
375, 5080	M27 x 2.00	38.5	6Y-7433



Inch

MODEL	THREAD SIZE (in - TPI)	A NUT HEIGHT In.	PART NUMBER
D8R/N, D8L, 583R, 578	7/8 - 14	1.38	7G-6442
D9R/N	1 - 14	1.57	7G-0434
D10, D10R/N	1 3/8 - 12	1.72	5P-8221
D11R/N, 5130	1 3/8 - 12	1.81	3T-6292

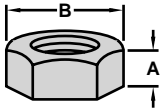

Cutting Edge Nuts

THREAD SIZE (in - TPI)	A HEIGHT (in)	B WIDTH (in)	PART NUMBER
1/2-20	0.44	3/4	6B-6684
5/8-11	0.55	15/16	1D-4720
5/8-11	0.55	15/16	4K-0367
3/4-10	0.64	1 1/8	2J-3506
3/4-16	0.64	1 1/8	6B-6682
7/8-9	0.75	1 5/16	2J-3505
1-8	0.86	1 1/2	2J-3507
1 1/4-7	1.06	1 7/8	3K-9770

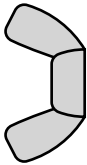

Wing Nuts / Inch / Coarse Thread UNC / Zinc Dichromate Plated

- Install and remove by hand.

THREAD SIZE (in - TPI)	PART NUMBER
10-24	6F-6898
10-32	033-3658
1/4-20	1F-1739
5/16-18	3B-0723
3/8-16	2B-9498
3/8-24	7B-8839

Hardware

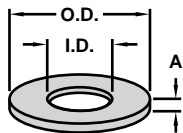

Washers / Flat / Inch

- Compatible with SAE Grade 8 bolts.

Phosphate and Oil Coated / Hardened

BOLT DIAMETER (in)	INSIDE DIAMETER (in)	OUTSIDE DIAMETER (in)	A THICKNESS (in)	PART NUMBER
1/4	0.28	0.56	0.08	5P-0537
5/16	0.34	0.62	0.08	9M-1974
3/8	0.39	0.72	0.09	5M-2894
7/16	0.50	0.88	0.09	5P-8244
1/2	0.53	1.00	0.12	5P-8245
9/16	0.62	1.14	0.12	5P-8246

BOLT DIAMETER (in)	INSIDE DIAMETER (in)	OUTSIDE DIAMETER (in)	A THICKNESS (in)	PART NUMBER
5/8	0.67	1.26	0.14	5P-8247
3/4	0.79	1.44	0.14	5P-8248
7/8	0.94	1.62	0.16	5P-8249
1	1.09	1.94	0.20	5P-8250
1 1/8	1.19	2.06	0.25	3S-1349
1 1/4	1.31	2.12	0.25	4K-0684
1 1/2	1.59	2.62	0.25	3S-6162

Zinc Dichromate Plated / Hardened

BOLT DIAMETER (in)	INSIDE DIAMETER (in)	OUTSIDE DIAMETER (in)	A THICKNESS (in)	PART NUMBER
1/4	0.28	0.56	0.08	8T-4205
5/16	0.34	0.62	0.08	8T-4224
3/8	0.41	0.72	0.09	8T-4896
7/16	0.47	0.88	0.09	8T-5360
1/2	0.53	1.00	0.12	8T-4223
5/8	0.66	1.25	0.14	8T-4122

BOLT DIAMETER (in)	INSIDE DIAMETER (in)	OUTSIDE DIAMETER (in)	A THICKNESS (in)	PART NUMBER
3/4	0.78	1.44	0.14	8T-4994
7/8	0.94	1.62	0.16	8C-6913
1	1.09	1.94	0.20	8T-5361
1 1/8	1.22	2.06	0.25	7X-0531
1 1/4	1.34	2.19	0.25	7X-0533
1 1/2	1.59	2.64	0.25	7X-0537

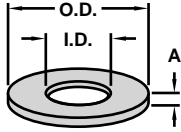

Washers / Flat / Inch

- Compatible with SAE Grade 5 bolts.

SAE

BOLT DIAMETER (in)	INSIDE DIAMETER (in)	OUTSIDE DIAMETER (in)	A THICKNESS (in)	PART NUMBER
No. 8	0.19	0.44	0.05	4B-4863
No. 10	0.22	0.50	0.06	4B-4274
1/4	0.28	0.62	0.06	4B-4276
5/16	0.34	0.69	0.06	4B-4277
3/8	0.41	0.81	0.06	4B-4278
7/16	0.47	0.94	0.06	4B-4279
1/2	0.53	1.06	0.09	4B-4280
9/16	0.59	1.19	0.09	4B-5059

BOLT DIAMETER (in)	INSIDE DIAMETER (in)	OUTSIDE DIAMETER (in)	A THICKNESS (in)	PART NUMBER
5/8	0.66	1.31	0.09	4B-4281
3/4	0.81	1.50	0.12	4B-4283
7/8	0.94	1.75	0.12	4B-4284
1	1.06	2.00	0.12	4B-4285
1 1/8	1.19	2.25	0.12	4B-5325
1 1/4	1.31	2.50	0.16	4B-5326
1 3/8	1.44	2.75	0.16	4B-4286
1 1/2	1.56	3.00	0.16	4B-5327

USS

BOLT DIAMETER (in)	INSIDE DIAMETER (in)	OUTSIDE DIAMETER (in)	A THICKNESS (in)	PART NUMBER
1/4	0.31	0.75	0.06	4B-5269
5/16	0.38	0.88	0.08	4B-5270
3/8	0.44	1.00	0.08	4B-5271
7/16	0.50	1.25	0.08	4B-5272
1/2	0.56	1.38	0.11	4B-5273
9/16	0.62	1.50	0.11	4B-5274

BOLT DIAMETER (in)	INSIDE DIAMETER (in)	OUTSIDE DIAMETER (in)	A THICKNESS (in)	PART NUMBER
5/8	0.69	1.75	0.14	4B-5275
3/4	0.81	2.00	0.14	4B-5276
7/8	0.94	2.25	0.16	4B-5277
1	1.06	2.50	0.16	4B-5278
1 1/4	1.38	3.00	0.17	4B-5280
1 3/8	1.50	3.25	0.17	4B-5281

Hardware

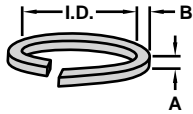

Lock Washers / Split Spring / Inch

- Made of high carbon, spring-tempered steel.
- Resist corrosion due to zinc dichromate plated finish.

Zinc Dichromate Plated / Non-Hardened

BOLT DIAMETER (in)	INSIDE DIAMETER (in)	A THICKNESS (in)	B WIDTH (in)	PART NUMBER
No. 6	0.14	0.03	0.05	9B-1117
No. 8	0.17	0.04	0.06	3B-4501
No. 10	0.20	0.05	0.06	3B-4502
1/4	0.26	0.11	0.08	3B-4504
5/16	0.32	0.13	0.10	3B-4505
3/8	0.38	0.14	0.12	3B-4506
7/16	0.45	0.13	0.16	3B-4507
1/2	0.52	0.15	0.18	3B-4508
9/16	0.57	0.19	0.17	3B-4509

BOLT DIAMETER (in)	INSIDE DIAMETER (in)	A THICKNESS (in)	B WIDTH (in)	PART NUMBER
5/8	0.63	0.21	0.19	3B-4510
3/4	0.76	0.23	0.19	3B-4512
7/8	0.88	0.27	0.22	3B-4514
1	1.01	0.30	0.25	3B-4516
1 1/8	1.14	0.33	0.28	3B-4518
1 1/4	1.26	0.36	0.31	3B-4520
1 3/8	1.39	0.39	0.34	3B-4522
1 1/2	1.51	0.42	0.38	3B-4524

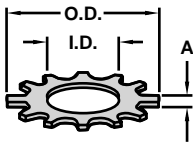

Lock Washers / External Tooth / Inch

- Provide “spring” action to keep assembly under tension.
- Resist corrosion due to zinc dichromate plated finish.

Zinc Dichromate Plated / Non-Hardened

BOLT DIAMETER (in)	INSIDE DIAMETER (in)	OUTSIDE DIAMETER (in)	A THICKNESS (in)	PART NUMBER
No. 6	0.15	0.31	0.02	5H-6555
No. 8	0.17	0.38	0.02	1H-4393
No. 10	0.20	0.40	0.02	9F-8125
1/4	0.26	0.50	0.03	1H-3338
5/16	0.33	0.59	0.03	7H-3937
3/8	0.39	0.69	0.04	4D-1326

BOLT DIAMETER (in)	INSIDE DIAMETER (in)	OUTSIDE DIAMETER (in)	A THICKNESS (in)	PART NUMBER
7/16	0.46	0.75	0.04	7F-6998
1/2	0.52	0.89	0.04	3J-4818

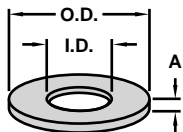

Washers / Flat / Metric

- Compatible with ISO property class 10.9.

Phosphate and Oil Coated / Hardened

BOLT DIAMETER (mm)	INSIDE DIAMETER (mm)	OUTSIDE DIAMETER (mm)	A THICKNESS (mm)	PART NUMBER
M6	6.60	12.00	2.00	9X-8267
M8	8.80	16.00	2.00	9M-1974
M10	11.00	21.00	2.50	6V-5839
M12	13.50	25.50	3.00	5P-8245
M14	15.50	29.00	3.00	5P-8246
M16	17.50	30.00	3.50	9X-8268

BOLT DIAMETER (mm)	INSIDE DIAMETER (mm)	OUTSIDE DIAMETER (mm)	A THICKNESS (mm)	PART NUMBER
M20	22.00	35.00	3.50	8T-3282
M24	26.00	44.00	4.00	6V-8237
M30	33.00	56.00	6.00	9X-8399

Zinc Dichromate Plated / Hardened

BOLT DIAMETER (mm)	INSIDE DIAMETER (mm)	OUTSIDE DIAMETER (mm)	A THICKNESS (mm)	PART NUMBER
M6	6.60	12.00	2.00	9X-8256
M8	8.80	16.00	2.00	8T-4224
M10	11.00	21.00	2.50	8T4121
M12	13.50	25.50	3.00	8T-4223
M16	17.50	30.00	3.50	9X-8257
M20	22.00	35.00	3.50	8T-4123
M24	26.00	44.00	4.00	8T-4167
M30	33.00	56.00	6.00	9X-8258

Hardware

Pan Head / Machine Screws / Inch

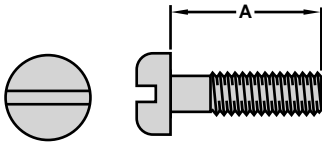

- Made of steel and finished with a zinc plating.
- Conform to ANSI B18.6.3 standard.

THREAD SIZE (in - TPI)	A SCREW LENGTH (in)	PART NUMBER
No. 6-32	3/8	2N-3474
	1/2	2N-3475
	3/4	2N-3476
	1	030-8838
	1 1/4	2N-3477
	1 1/2	033-4815
No. 8-32	3/4	7S-4338
	1 1/4	6V-7697
	1 1/2	7S-1198
	2	5S-9105

THREAD SIZE (in - TPI)	A SCREW LENGTH (in)	PART NUMBER
No. 10-24	3/8	2N-3478
	1/2	2N-3479
	3/4	2N-3480
	1 1/4	2N-3162
	1 1/2	2N-7456
1/4-20	3/8	030-9614
	5/8	3K-6881
	3/4	2Y-1020
	1	7H-1246

Round Head / Machine Screws / Inch

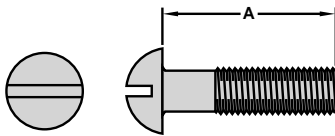

- Made of steel and finished with a zinc plating.
- Conform to ANSI B18.6.3 standard.

THREAD SIZE (in - TPI)	A SCREW LENGTH (in)	PART NUMBER
No. 6-32	1/4	4B-1218
	3/8	5S-7348
	1/2	4B-9762
	1 1/4	010-0744
	1 1/2	010-0746
No. 8-32	1/4	9B-7242
	3/8	4B-1220
	1/2	4B-1221
	3/4	5M-6668
	1	3K-8106

THREAD SIZE (in - TPI)	A SCREW LENGTH (in)	PART NUMBER
No. 10-24	1/4	4B-1226
	3/8	4B-1227
	1/2	4B-1229
	3/4	4B-1232
	1 1/4	4B-1234
	1 1/2	011-0508
	2	032-8924

Flat Head / Machine Screws / Inch / Coarse Thread

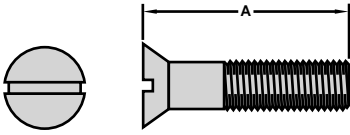

- Made of steel and finished with a zinc plating.
- Conform to ANSI B18.6.3 standard.

THREAD SIZE (in - TPI)	A SCREW LENGTH (in)	PART NUMBER
No. 10-24	3/8	4B-1293
	1/2	4B-1273
	5/8	4B-1274
	3/4	2H-6120
	1	1H-8456
	1 1/4	5P-5583
	1 1/2	8T-9514
	1 3/4	5P-5582
No. 6-32	3/8	5D-0853
	1/2	7K-3435

THREAD SIZE (in - TPI)	A SCREW LENGTH (in)	PART NUMBER
No. 6-32	3/4	2D-6327
No. 8-32	1/2	4B-1268
	5/8	4B-1269
	3/4	4B-1270
1/4-20	3/8	2M-5139
	1	4B-1284
	1 1/4	4B-1285
	1 1/2	1H-8294
	1 3/4	1H-8298
5/16-18	1/2	4B-1286

THREAD SIZE (in - TPI)	A SCREW LENGTH (in)	PART NUMBER
5/16-18	1 1/4	1H-8293
	1 1/2	1H-8658
	1 3/4	5P-0399
3/8-16	3/4	1H-8296
	1	4B-1291
	1 1/4	5B-7431
	1 1/2	8F-6987
	1 3/4	8H-9579

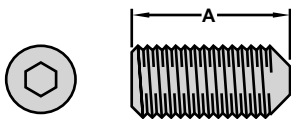

Cup Point / Set Screws / Inch / Coarse Thread UNC

- Heat treated with a black oxide finish.

THREAD SIZE (in - TPI)	A SCREW LENGTH (in)	PART NUMBER
No. 10-24	1/4	5B-9324
	3/8	8C-8430
	1/2	4B-3627
1/4-20	1/4	4B-9806
	3/8	010-2570
	1/2	4B-9808
	5/8	1K-6979
	3/4	010-2573
	1	010-3575
5/16-18	1/4	010-2580

THREAD SIZE (in - TPI)	A SCREW LENGTH (in)	PART NUMBER
5/16-18	3/8	8B-7179
	1/2	010-2582
	3/4	5P-2556
	1	2H-3907
3/8-16	1/4	010-2591
	3/8	2F-5326
	1/2	3B-8601
	5/8	2F-5325
	3/4	3H-8430
	1	010-2597

THREAD SIZE (in - TPI)	A SCREW LENGTH (in)	PART NUMBER
1/2-13	1/2	010-2615
	5/8	010-2616
	3/4	4B-1771
	1	2H-3906

Hardware

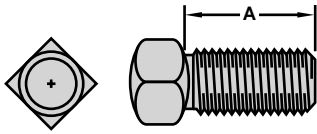

Square Head / Set Screws / Inch / Coarse Thread UNC

- Made of case-hardened steel with a full square head.

THREAD SIZE (in - TPI)	A SCREW LENGTH (in)	PART NUMBER
1/4-20	3/8	4B-3565
	1/2	4B-3566
	1	4B-3569
5/16-18	1/2	4B-3570
	5/8	4B-3571
3/8-16	1/2	4B-3572
	5/8	4B-3573
	3/4	4B-3574
	7/8	4B-4994
	1	4B-3575

THREAD SIZE (in - TPI)	A SCREW LENGTH (in)	PART NUMBER
3/8-16	1 1/4	4B-3576
	1 1/2	4B-3577
	1 3/4	2H-3881
1/2-13	3/4	4B-3580
	7/8	4B-3581
	1	4B-3582
	1 1/4	4B-3583
	1 1/2	4B-3584
	1 3/4	4B-3585
2	4B-3586	

THREAD SIZE (in - TPI)	A SCREW LENGTH (in)	PART NUMBER
5/8-11	1 1/2	4B-3594
	1 3/4	4B-3595
	2	4B-3596
	2 1/2	4B-3598
	3	4B-3599
3/4-10	1 1/2	4B-3601
	1 3/4	4B-3602
	2	4B-3603
	2 1/2	4B-3604
	3	4B-3605

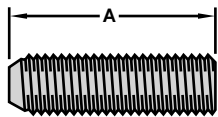

Taper Lock / Studs / Inch / Coarse Thread UNC

- Heat treated with a direct-hardening process.
- Hardened to Rockwell C 33 - 39.
- Designed with a taper point for a plug tap.
- Meet SAE grade 8 strength requirements.

THREAD SIZE (in - TPI)	A SCREW LENGTH (in)	PART NUMBER
3/8-16	1 9/16	2M-1538
	1 3/4	2M-4779
	2	1J-8668
	2 3/16	4M-2743
	2 3/8	8M-1871
	2 5/8	3M-0496
	2 13/16	7S-6719
	2 15/16	9M-3296
	3 1/8	2M-8411
	3 9/16	2M-2488
4	6L-4428	
1/2-13	1 9/16	8M-8778

THREAD SIZE (in - TPI)	A SCREW LENGTH (in)	PART NUMBER
1/2-13	1 3/4	2D-8153
	2	3D-0490
	2 3/16	5M-1932
	2 3/8	2D-8154
	2 5/8	4J-6925
	2 13/16	3D-0472
	2 15/16	3D-6627
	3 1/8	2D-8426
	3 9/16	2D-8155
	4	3D-0471
5/8-11	2 3/16	3D-4639
	2 3/8	2D-8822

THREAD SIZE (in - TPI)	A SCREW LENGTH (in)	PART NUMBER
5/8-11	2 5/8	2D-5238
	2 13/16	4D-4823
	2 15/16	6L-7655
	3 1/8	3J-8154
	3 9/16	3D-5963
	4	5P-3887
3/4-10	2 5/8	4D-6579
	2 13/16	2D-8369
	2 15/16	4D-6578
	3 1/8	4D-7246
	3 9/16	5J-6796
	4	2P-1303

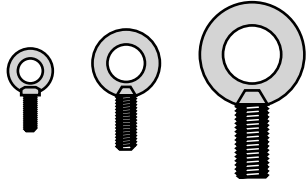

Lifting Eyebolts / Inch

THREAD SIZE (in - TPI)	MAXIMUM WORKING LOAD								PART NUMBER
	0°		30°		60°		90°		
	(lbs)	(kg)	(lbs)	(kg)	(lbs)	(kg)	(lbs)	(kg)	
1/4-20	400	180	70	32	—	—	—	—	1P-7403
5/16-18	680	308	200	91	—	—	—	—	1P-7404
3/8-16	1000	453	375	170	200	91	155	70	1P-7405
7/16-14	1380	625	500	227	300	136	235	107	1P-7406
1/2-13	1840	835	805	365	470	213	395	179	1P-7407
5/8-11	2940	1330	1340	608	805	365	670	304	2D-1201
3/4-10	4340	1960	2115	959	1180	540	1040	472	1P-7409

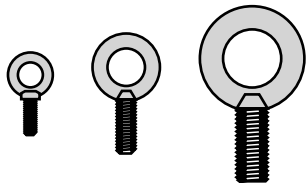

Lifting Eyebolts / Metric

THREAD SIZE (dia x pitch)	MAXIMUM WORKING LOAD				PART NUMBER
	0°		<=45°		
	(lbs)	(kg)	(lbs)	(kg)	
M8 x 1.25	350	160	175	80	3E-3882
M16 x 2.00	1380	630	690	315	3E-3879
M20 x 2.50	2200	1000	1100	500	3E-3880
M24 x 3.00	3520	1600	1760	800	3E-3881
M64 x 6.00	35270	16000	17635	8000	3E-3878

Hardware

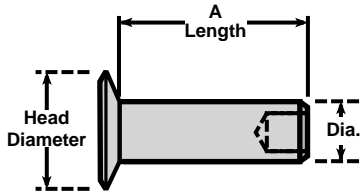

Rivets / Flat Head / Countersunk Shank / Inch

BODY DIAMETER (in)	A LENGTH (in)	HEAD DIAMETER (in)	PART NUMBER	MATERIAL
5/32	5/16	3/8	6B-4284	STEEL
3/16	9/32	3/8	7B-5048	BRASS
3/16	5/16	3/8	7B-5050	BRASS
3/16	3/8	3/8	7B-5054	BRASS
3/16	13/32	3/8	7B-5056	BRASS
3/16	15/32	3/8	7B-5060	BRASS
3/16	1/2	3/8	7B-5062	BRASS
3/16	17/32	3/8	6B-1985	STEEL
3/16	17/32	3/8	7B-5064	BRASS
3/16	19/32	3/8	6B-4594	STEEL
3/16	19/32	3/8	7B-5068	BRASS
3/16	19/32	3/8	7B-5068	BRASS
3/16	19/32	3/8	7B-5068	BRASS
3/16	3/4	3/8	6B-1369	STEEL

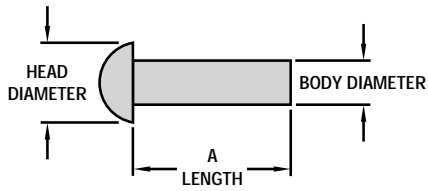

Rivets / Button Head / Solid Shank / Inch

- Made of cold-formed steel.
- Meet ANSI B18.1.1 requirements.

BODY DIAMETER (in)	A LENGTH (in)	HEAD DIAMETER (in)	PART NUMBER
1/8	1/4	0.23	4B-4304
1/8	3/8	0.23	4B-4306
1/8	1/2	0.23	4B-4307
3/16	3/8	0.34	4B-4310
3/16	1/2	0.34	4B-4311
3/16	5/8	0.34	4B-4312
3/16	3/4	0.34	4B-4314
3/16	7/8	0.34	1J-6280
3/16	1	0.34	4B-4315
1/4	3/8	0.45	4B-4319
1/4	1/2	0.45	4B-4320
1/4	5/8	0.45	4B-4321
1/4	3/4	0.45	4B-4322
1/4	7/8	0.56	1F-3577
1/4	1 1/8	0.45	4B-4325
5/16	5/8	0.56	4B-4334
5/16	3/4	0.56	4B-4335
5/16	7/8	0.56	4B-4336
5/16	1	0.56	4B-4337
3/8	3/4	0.67	4B-4343
3/8	7/8	0.67	4B-4344
3/8	1	0.67	4B-4345
3/8	1 1/8	0.67	4B-4346
3/8	1 1/4	0.67	4B-4347

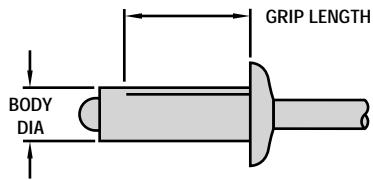

Rivets / Blind / Inch

- Contain an open-end and a steel mandrel.

BODY DIAMETER (in)	GRIP LENGTH (in)	PART NUMBER
1/8	3/8 - 1/2	6K-3273
1/8	1/8 - 3/16	7K-6536
1/8	1/16 - 1/8	8L-7905
1/8	5/16 - 3/8	9M-5731
5/32	1/4 - 3/8	034-7044
5/32	1/8 - 1/4	2N-2258
3/16	3/8 - 1/2	033-9412
3/16	1/2 - 5/8	4D-6716
3/16	1/4 - 3/8	9M-5732
3/16	1/8 - 1/4	9M-5733

Spring Pins / Roll Pin / Inch

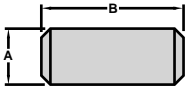

- Contain a chamfered end for easy installation.
- Made of heat-treated steel.

A DIAMETER (in)	B PIN LENGTH (in)	PART NUMBER
1/16	1/4	8S-7499
	3/8	1L-5316
	1/2	8S-3157
	3/4	2L-4911
3/32	1/2	3H-1118
	5/8	2K-3455
	3/4	2L-5894
	1	5M-8009
	1 1/4	032-8870
1/8	1/2	3H-9675
	5/8	4H-1641
	3/4	3K-4897
	1	8T-0277
	1 1/4	2K-8467
5/32	3/8	8L-6565
	1/2	1T-0099
	3/4	2L-5893
	1	5H-9839
	1 1/2	6V-3259
3/16	1/2	5H-8985
	5/8	2K-5986
	3/4	4H-8380
	1	6H-3956
	1 1/4	1H-1200
	1 1/2	4H-3119

A DIAMETER (in)	B PIN LENGTH (in)	PART NUMBER
3/16	1 3/4	1J-5799
1/4	1/2	6B-6863
	5/8	3H-2617
	3/4	7M-5130
	1	5H-3182
	1 1/4	5H-3193
	1 1/2	2L-1699
	1 3/4	4H-4737
	2	4H-6996
	2 1/2	1J-5353
	5/16	3/4
1		1T-0550
1 1/2		2H-9445
1 3/4		5M-1179
2		2M-3521
3		2K-1594
3/8	5/8	1T-0068
	3/4	8T-5089
	1	2L-3650
	1 1/4	5J-3941
	1 1/2	2J-5850
	1 3/4	5L-5711
	2	1J-8136
1/2	3	045-7012
	3/4	7K-6820

A DIAMETER (in)	B PIN LENGTH (in)	PART NUMBER
1/2	1	1N-5981
	1 1/4	2K-9062
	1 1/2	5H-4905
	2 1/2	2K-8078
	3	027-3873
	3 1/2	031-0255
	4	8C-8513

Hardware

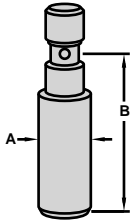

TYPE 1

Drawbar and Clevis Pins / Type I

A DIAMETER (in)	PIN HOLE DIAMETER (in)	B LENGTH (in)	PART NUMBER
1 1/2	25/64	9 7/8	5H-8812
2	25/64	8 3/8	9S-8184
2	25/64	9 3/8	2R-0179
2 15/64	25/64	10 3/8	1H-4106

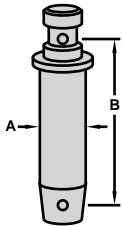

TYPE 2

Drawbar and Clevis Pins / Type II

A DIAMETER (in)	PIN HOLE DIAMETER (in)	B LENGTH (in)	PART NUMBER
1 1/2	25/64	7	7F-9549
1 1/2	25/64	8	7F-9544
1 35/64	25/64	9	7F-9541
1 3/4	25/64	8	7F-9547
1 3/4	25/64	12	5H-2209
2	25/64	10 1/2	2M-0093

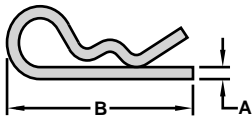

Locking Pins /Inch / Steel

A DIAMETER (in)	PIN HOLE DIAMETER (in)	B LENGTH (in)	PART NUMBER
3/32	1/4 - 1/2	1.62	5P-0372
3/32	1/2	2.00	008-3843
1/8	1/2 - 3/4	1.75	6S-6646
1/8	5/8 - 7/8	2.50	8S-6377
5/32	5/8 - 7/8	3.00	5P-0370
3/16	3/4 - 11/16	3.75	5P-8837

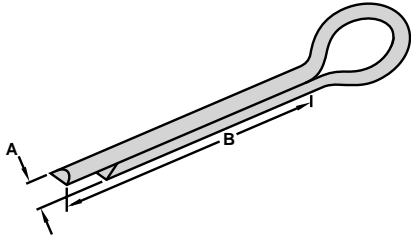

Cotter Pins / Inch / Zinc Plated Steel

A DIAMETER (in)	B PIN LENGTH (in)	PART NUMBER
1/16	3/4	3B-4605
	1 1/4	3B-4606
	1 1/2	010-3365
3/32	1/2	3B-4607
	3/4	1S-0685*
	1	3B-4611
	1	6F-3465*
	1 1/4	3B-4612
	1 1/2	3B-5312
	1 3/4	2H-3862
	2	010-3378
1/8	1/2	3B-4613
	3/4	3B-4615
	1	3B-4617
	1 1/4	3B-4618
	1 1/4	6F-5264*
	1 1/2	5H-9456*
	1 3/4	6H-5800*
	2	3B-4621
	2	7F-2002*
	2 1/4	3B-4622
	2 1/2	8B-9264
9/64	1	1S-1083*
	1 1/4	9M-6505*
5/32	1 1/4	3B-4624
	1 1/2	3B-5301
	1 3/4	7B-1331

A DIAMETER (in)	B PIN LENGTH (in)	PART NUMBER
5/32	2	2H-3768
	2 1/4	010-3401
	2 3/4	3B-4625
3/16	1	3B-4627
	1 1/4	3B-4628
	1 1/2	3B-4629
	2	3B-4631
	2 1/4	3B-5302
	2 1/2	3B-4632
	2 3/4	3B-4633
	3	3B-4634
	4	3B-4636
	1/4	1
1 1/4		3B-4637
1 1/2		3B-5313
1 3/4		3B-4639
2		3B-4640
2 1/4		3B-5303
2 1/2		3B-4641
3		3B-5328
3 1/2		3B-4643
4		8T-1459
5/16	4 1/2	4D-8002
	1	3B-6705
	1 1/4	2H-3770
	1 1/2	2H-3771
5/8	2	3B-5314

A DIAMETER (in)	B PIN LENGTH (in)	PART NUMBER
5/16	2 1/4	3B-5315
	2 1/2	3B-5316
	3	3B-5317
	3 1/2	2H-3772
	4	2H-3773
	4 1/2	3F-8357
	5	2H-3774
	3/8	1 1/4
1 1/2		3B-4644
1 3/4		3B-4645
2		3B-4646
2 1/2		3B-4647
2 3/4		3B-5319
3		3B-5320
3 1/2		3B-5322
4		3B-5329
4 1/2		4J-1888
1/2	2	3B-5323
	2 1/2	3B-5324
	2 3/4	3B-5325
	3	2H-3775
	3 1/2	3B-5326
	5	1J-2920
	5 1/2	3J-2985
5/8	3	3B-5327

* Double head cotter pin.

Hardware

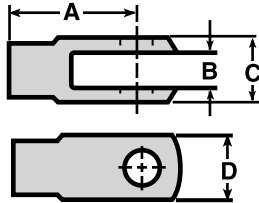

Yoke-Type Rod End / Inch

DIAMETER (in)	A LENGTH TO PIN HOLE (in)	B GAP SIZE (in)	C HEIGHT (in)	D WIDTH (in)	PART NUMBER	NUT	PIN ASSY.	CLEVIS PIN	RETAIN. CLIP	RETAIN. PIN	COTTER PIN
1/4	26.2	7.10	15.90	12.70	2M-4036	5L-4426		4B-3057			3B-4607
1/4	50.8	7.10	15.90	12.70	8B-3768	5L-4426		4B-3057			3B-4607
5/16	30.2	8.70	19.00	15.00	3D-9609	1B-4202		1A-2457			3B-4609
5/16	57.0	8.70	18.00	15.00	010-4037	1B-4202		1A-2457			3B-4609
3/8	34.9	11.10	22.20	17.50	1M-1341	1B-4203	8T-8932				
3/8	34.9	11.10	22.20	17.50	1M-1341	1B-4203		1B-0676			3B-4615
3/8	63.5	11.10	22.20	17.50	1A-9252	1B-4203		1B-0676			3B-4615
1/2	46.0	14.30	28.60	23.90	2M-8340	9S-5585		8B-1419		6S-6646	
1/2	46.0	14.30	28.60	23.90	2M-8340	9S-5585		8B-1419			3B-4617
1/2	76.2	14.30	28.60	23.90	6F-7010	9S-5585		8B-1419		6S-6646	
1/2	76.2	14.30	28.60	23.90	6F-7010	9S-5585		8B-1419			3B-4617
5/8	57.9	17.50	34.90	30.20	4M-7930	5D-3183		9S-1315			3B-4617
5/8	125.4	17.50	34.90	30.20	9S-1314	5D-3183		9S-1315			3B-4617

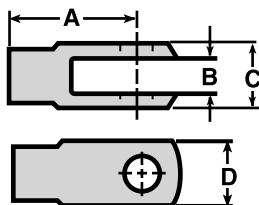

Yoke-Type Rod End / Metric

DIAMETER (mm)	A LENGTH TO PIN HOLE (mm)	B GAP SIZE (mm)	C HEIGHT (mm)	D WIDTH (mm)	PART NUMBER	NUT	PIN ASSY.	CLEVIS PIN	RETAIN. CLIP	RETAIN. PIN	COTTER PIN
M6	36.0	6.0	12.0	12.0	8T-4742	5C-2890	8T-4744	8T-6904	8T-6902		
M10	40.0	10.0	20.0	20.0	8T-4815	8T-4133	8T-4743	9R-2806	9R-2807		
M10-LH	60.0	10.0	20.0	20.0	8C-6955	9X-2065	8T-5381	9R-2806	9R-2807		
M10	60.0	10.0	20.0	20.0	8T-5063	8T-4133	8T-5381	9R-2806	9R-2807		
M12	48.0	12.2	24.0	24.0	8C-3393	8T-4244	8C-3394	8T-6905	8T-6903		
M12	48.0	12.2	24.0	24.0	8C-3393	8T-4244		7X-3161		6S-6646	3B-4615
M12-LH	72.0	12.0	24.0	24.0	7X-0858	8T-4244	8T-5382	8T-6905	8T-6903		
M12-LH	72.0	12.0	24.0	24.0	7X-0858	8T-4244		7X-3161		6S-6646	3B-4615
M12	72.0	12.0	24.0	24.0	8T-4650	8T-4244	8T-5382	8T-6905	8T-6903		
M12	72.0	12.0	24.0	24.0	8T-4650	8T-4244		7X-3161		6S-6646	3B-4615

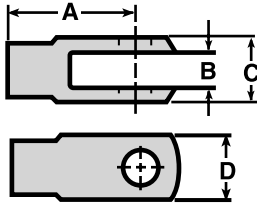

Yoke-Type Rod End / Jump Sizes / Metric

DIAMETER (mm)	A LENGTH TO PIN HOLE (mm)	B GAP SIZE (mm)	C HEIGHT (mm)	D WIDTH (mm)	PART NUMBER	NUT	PIN ASSY.	CLEVIS PIN	RETAIN. CLIP	RETAIN. PIN	COTTER PIN
M10**	40.0	10.0	20.0	20.0	3E-3826	8T-4133		1B-0676		6S-6646	3B-4615
M10*	40.0	10.0	20.0	20.0	8T-5921	8T-4133					

* 6.0 mm bore.

** 9.5 mm bore.

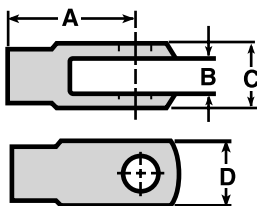

Yoke-Type Rod End / Forged / Metric

DIAMETER (mm)	A LENGTH TO PIN HOLE (mm)	B GAP SIZE (mm)	C HEIGHT (mm)	D WIDTH (mm)	PART NUMBER	NUT	PIN ASSY.	CLEVIS PIN	RETAIN. CLIP	RETAIN. PIN	COTTER PIN
M6*	45.0	7.1	15.9	13.0	7X-2496	5C-2890		7X-2618			3B-4607
M10**	34.9	11.1	22.2	17.5	8T-4968	8T-4133		1B-0676		6S-6646	3B-7615
M10**	63.5	11.1	22.2	17.5	8T-3988	8T-4133		1B-0676		6S-6646	3B-7615
M12***	46.4	14.3	28.6	23.9	7X-7660	8T-4244		8B-1419			3B-4617

* External thread.

*** 12.7 mm bore.

** 9.5 mm bore.

Hardware

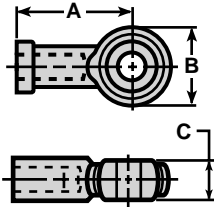

Spherical Rod End / Inch

DIAMETER (in)	A LENGTH TO PIN HOLE (in)	B DIAM. (in)	C HEIGHT (in)	D WIDTH (in)	PART NUMBER	NUT	PIN ASSY.	CLEVIS PIN	RETAIN. CLIP	RETAIN. PIN	COTTER PIN
1/4	1.33	0.89	0.37		6L-7751						
5/16	1.37	1.02	0.44		7H-3641						
3/8	1.64	1.13	0.50		4D-4064						
1/2	2.12	1.39	0.63		4D-4065						

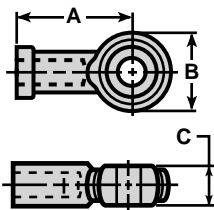

Spherical Rod End / Metric

DIAMETER (mm)	A LENGTH TO PIN HOLE (mm)	B DIAM. (mm)	C HEIGHT (mm)	D WIDTH (mm)	PART NUMBER	NUT	PIN ASSY.	CLEVIS PIN	RETAIN. CLIP	RETAIN. PIN	COTTER PIN
M6	29.0	22.0	9.0		8C-3111						
M8	35.0	26.0	12.0		7X-7915						
M10	42.0	30.0	14.0		8T-6431						
M12	49.0	34.0	19.0		8C-3392						
M16	63.0	42.0	21.0		9R-4760						

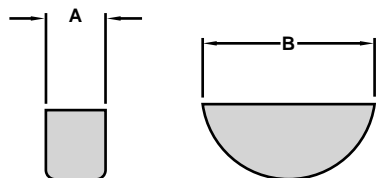

Woodruff Keys

- Made of medium carbon steel and machined to a smooth finish.

A THICKNESS (in)	B DIAMETER (in)	SAE NUMBER	PART NUMBER
1/16	5/16	206	4F-2291
1/16	3/8	211	3B-2098
1/16	1/2	1	1F-3130
3/32	5/16	207	8B-9318
3/32	3/8	212	1B-8735
3/32	1/2	2	1B-8701
3/32	5/8	4	1B-8703
1/8	3/8	213	5H-2532
1/8	1/2	3	1B-8702
1/8	5/8	5	1B-8704
1/8	3/4	7	1B-8706
5/32	5/8	6	1B-8705
5/32	3/4	8	1B-8707
5/32	7/8	10	1B-8709
3/16	3/4	9	1B-8708
3/16	7/8	11	1B-8710
3/16	1	13	1B-8712
3/16	1 1/8	16	1B-8715
7/32	1	14	3K-4723
1/4	3/4	91	2B-9373
1/4	7/8	A	1B-8736
1/4	1	15	1B-8714
1/4	1 1/8	18	1B-8716
1/4	1 1/4	21	1B-8719
1/4	1 3/8	22	1B-8720
1/4	1 1/2	24	1B-8722
5/16	1	B	1H-6627
5/16	1 1/8	C	1B-8737
5/16	1 1/4	D	1B-8738
5/16	1 3/8	23	1B-8721
5/16	1 1/2	25	1B-8723
3/8	1 1/4	E	1B-8739
3/8	1 3/8	F	1B-8740
3/8	1 1/2	G	1B-8741
3/8	2 3/4	T	1B-8743

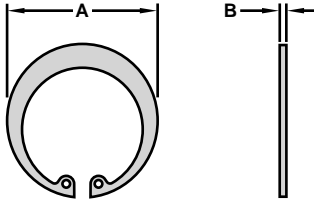

Snap Rings / Internal / Inch

- Made of tempered carbon steel.

BORE DIAMETER (in)	A FREE DIAMETER (in)	B THICKNESS (in)	PART NUMBER
0.44	0.48	0.025	3D-8358
0.50	0.55	0.035	1S-1638
0.56	0.62	0.035	2R-1256
0.69	0.76	0.035	1H-4142
0.75	0.83	0.035	2M-8191
0.81	0.90	0.042	5S-4455
0.88	0.97	0.042	2L-6726
0.90	1.00	0.042	4L-1466
1.00	1.11	0.042	4D-1322
1.12	1.25	0.050	5S-1522
1.25	1.39	0.050	2D-6398
1.38	1.53	0.050	1L-3768
1.44	1.60	0.050	2H-1142
1.50	1.66	0.062	8N-7294
1.56	1.73	0.062	3K-9879
1.65	1.83	0.062	2R-1230
1.81	2.01	0.062	2D-5826
1.85	2.05	0.078	1L-8490
2.05	2.28	0.078	6J-7855
2.31	2.54	0.078	2D-6648
2.44	2.70	0.078	6L-8797
2.50	2.77	0.078	4D-1736
2.75	3.05	0.093	6K-3531
2.83	3.12	0.093	2H-5549
3.00	3.33	0.093	2R-1236
3.16	3.52	0.109	1K-6985
3.25	3.62	0.109	8J-7636
3.50	3.89	0.109	3D-8341
3.56	3.94	0.109	1J-6472
3.88	4.29	0.109	9M-9935
4.00	4.42	0.109	7M-2275
4.33	4.76	0.109	5L-4751
4.72	5.21	0.109	067-3161

BORE DIAMETER (in)	A FREE DIAMETER (in)	B THICKNESS (in)	PART NUMBER
5.00	5.49	0.109	2L-0043
6.00	6.62	0.125	5L-4756
7.00	7.72	0.156	1L-7388
7.50	8.27	0.187	7F-6021

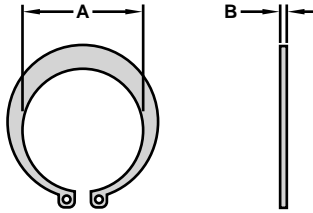

Snap Rings / External / Inch

- Made of tempered carbon steel.

SHAFT DIAMETER (in)	A FREE DIAMETER (in)	B THICKNESS (in)	PART NUMBER
0.25	0.22	0.025	6H-5829
0.38	0.34	0.025	9M-7611
0.44	0.40	0.025	4H-0094
0.47	0.43	0.025	6L-3801
0.56	0.52	0.035	3D-2975
0.59	0.55	0.035	2L-8509
0.62	0.58	0.035	8F-4610
0.75	0.69	0.042	2J-6356
0.81	0.75	0.042	9F-5444
0.94	0.87	0.042	6H-6109
0.98	0.91	0.042	1L-8497
1.00	0.93	0.042	001-5600
1.06	0.98	0.050	3K-8276
1.12	1.04	0.050	5L-4019
1.19	1.10	0.050	4M-5285
1.25	1.16	0.050	2M-4287
1.31	1.21	0.050	4D-8309
1.38	1.27	0.050	1J-6474
1.56	1.45	0.062	2L-6965
1.62	1.50	0.062	9L-2336
1.69	1.56	0.062	5L-2931
1.77	1.64	0.062	2J-7550
1.81	1.68	0.062	5K-9106
1.88	1.74	0.062	1K-6995
1.97	1.82	0.062	077-9687
2.12	1.96	0.078	1K-6984
2.16	1.99	0.078	4K-4284
2.50	2.31	0.078	5K-4627
2.56	2.38	0.078	6S-1753
2.62	2.43	0.078	1K-6992
2.75	2.54	0.093	5J-3864
2.94	2.72	0.093	7J-6580
3.16	2.92	0.093	1N-8620

SHAFT DIAMETER (in)	A FREE DIAMETER (in)	B THICKNESS (in)	PART NUMBER
3.35	3.09	0.093	9S-4368
3.50	3.24	0.109	5L-4753
3.62	3.35	0.109	7J-6525
4.00	3.70	0.109	8F-1959
4.25	3.99	0.109	1N-5410
4.38	4.11	0.109	5H-5012
4.75	4.46	0.109	2L-0049
5.75	5.40	0.125	5L-8579
6.25	5.87	0.156	2L-0044

Hardware

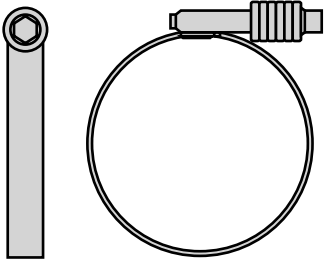

Hose Clamps / Uniform Load

WORKING DIAMETER		PART NUMBER
(in)	(mm)	
1 1/4 - 2 1/8	32-54	8T-4983
1 3/4 - 2 5/8	45-67	8T-6703
2 1/4 - 3 1/8	57-79	8T-4984
2 3/4 - 3 5/8	70-92	8T-6675
3 1/4 - 4 1/8	83-105	8T-4985
4 1/4 - 5 1/8	108-130	8T-4986
5 1/4 - 6 1/8	133-156	8T-4987
6 1/4 - 7 1/8	159-181	8T-4988
7 1/4 - 8 1/8	184-206	8T-4989
8 1/4 - 9 1/8	210-232	8T-4990

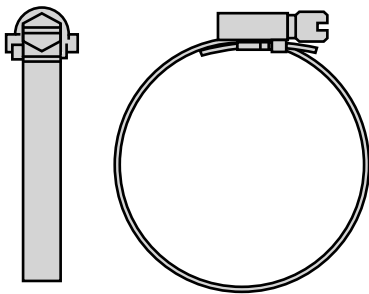

Hose Clamps

WORKING DIAMETER		PART NUMBER
(in)	(mm)	
7/32 - 5/8	6-16	1P-4278
9/16 - 11/16	16-27	5D-1026
15/16 - 1 3/4	24-45	9M-7958
1 9/16 - 2 1/2	40-64	9M-0164
2 9/16 - 3 1/2	65-89	9M-7959
3 5/16 - 4 1/4	89-108	9M-6738

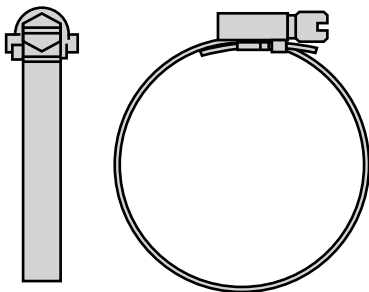

Hose Clamps / Heavy Duty

WORKING DIAMETER		PART NUMBER
(in)	(mm)	
1 1/4 - 2	32-51	5P-2230
1 3/4 - 2 5/8	45-67	5P-0597
2 1/8 - 4 1/8	54-105	5P-0598
4 - 6 1/8	102-156	5P-0599
6 - 9	156-229	5P-0600

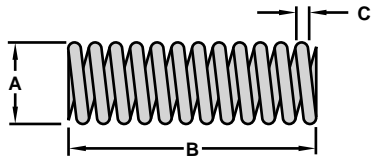

Springs / Compression

A OUTSIDE DIAMETER (in)	B LENGTH (in)	C WIRE DIAMETER (in)	PART NUMBER
1/4	5/16	0.031	9N-1747
	3/8	0.031	9L-9522
	1/2	0.031	091-7106
	9/16	0.031	3G-0670
	3/4	0.031	7V-3827
	13/16	0.031	090-5957
	1	0.063	4T-7794
	1 5/16	0.063	1V-8784
	1 1/2	0.031	9N-4049
	2 1/4	0.031	9N-1622
	2 13/16	0.063	8J-9273
3/8	1/2	0.031	6B-3364
	9/16	0.063	7M-3801
	5/8	0.031	7M-7446
	3/4	0.031	3K-7217
	7/8	0.063	4K-8350
	15/16	0.031	9S-1347
	1	0.031	1V-9969
	1 1/8	0.031	9L-6422
	1 1/4	0.031	3N-6233
	1 1/2	0.031	5B-1890
	1 5/8	0.031	6N-8793
	1 3/4	0.031	2V-3457
	1 7/8	0.063	6P-4993
	2 3/16	0.063	7N-0426
	2 1/4	0.031	2L-4403
	2 1/2	0.031	7F-7276
	2 5/8	0.094	2H-5062
	3 1/8	0.094	1P-9602
	3 3/8	0.094	7B-9411
	3 5/8	0.094	4M-5912
4	0.031	034-3705	
1/2	5/8	0.031	6F-0967
	1	0.031	5K-3918
	1 1/4	0.031	5F-7464
	1 1/2	0.063	6Y-0172

A OUTSIDE DIAMETER (in)	B LENGTH (in)	C WIRE DIAMETER (in)	PART NUMBER
1/2	1 5/8	0.031	3C-0585
	1 3/4	0.125	3G-7402
	1 7/8	0.063	9M-1986
	2	0.031	7M-7244
	2 1/4	0.063	0L-1466
	2 1/2	0.063	6P-7701
	2 5/8	0.031	3N-5738
	3 1/4	0.031	0L-1142
	3 3/4	0.063	5B-1952
	3 7/8	0.094	5J-9605
	4 1/4	0.063	5B-8858
	4 3/4	0.063	5M-6110
	4 7/8	0.094	3T-7584
	5 3/8	0.094	6T-1318
	5 7/8	0.094	9S-9876
	5/8	3/8	0.094
1/2		0.063	6T-8234
5/8		0.031	9N-6249
1		0.188	6B-3416
1 1/8		0.094	6S-8736
1 1/4		0.094	9M-3091
1 1/2		0.063	5B-3754
1 13/16		0.063	3F-8845
1 7/8		0.094	4F-9503
2		0.094	9W-1467
2 1/8		0.063	2P-5700
2 1/4		0.063	5J-1787
2 1/2		0.063	2F-5889
2 3/4		0.063	4F-6145
3 1/8		0.094	4J-4051
3 1/4		0.063	1W-6077
3 3/8	0.125	3P-7566	
3 1/2	0.063	6P-9784	
3 3/4	0.125	4T-4033	
4 3/8	0.094	2P-4498	
4 1/2	0.125	9T-1676	

Hardware

Springs — Compression

A OUTSIDE DIAMETER (in)	B LENGTH (in)	C WIRE DIAMETER (in)	PART NUMBER
3/4	7/8	0.031	4T-2684
	1	0.125	6F-4294
	1 3/8	0.031	3N-7848
	1 1/2	0.094	7M-3496
	1 5/8	0.125	5F-2201
	2	0.063	5F-9035
	2 1/4	0.094	7G-5378
	2 3/8	0.125	9S-8237
	2 1/2	0.125	1K-4476
	2 5/8	0.125	3D-2777
	2 7/8	0.063	8F-3398
	3	0.156	1K-9105
	3 1/8	0.094	6H-1649
	3 3/8	0.094	5H-7473
	3 5/8	0.094	1U-1067
	3 7/8	0.063	2H-6117
	4	0.125	1S-5646
	4 1/4	0.094	9F-6092
	4 1/2	0.031	9T-8208
	4 7/8	0.094	2S-6538
7/8	7/16	0.063	3P-8042
	15/16	0.063	9P-9211
	1 3/16	0.094	8J-6080
	2	0.094	9S-8632
	2 3/16	0.094	9H-4204
	2 7/16	0.125	4M-6012
	2 7/8	0.125	1W-9860
	3	0.125	5N-3015
	3 1/8	0.125	3P-0246
	3 3/8	0.125	1W-2208
	3 1/2	0.125	9L-9243
	4 3/8	0.063	5M-6111
	4 1/2	0.094	6K-4302
	4 5/8	0.125	6B-8809
	5 3/8	0.156	4D-7637
	5 1/2	0.094	7M-1405
	5 5/8	0.156	5D-6293
	5 15/16	0.094	4H-1221
	6 7/16	0.125	4D-9469
	7 1/4	0.125	7D-6198
1	5/8	0.063	9T-1699
	7/8	0.125	7W-2110

A OUTSIDE DIAMETER (in)	B LENGTH (in)	C WIRE DIAMETER (in)	PART NUMBER
1	1	0.094	7V-0444
	1 1/8	0.094	9P-8308
	1 1/4	0.094	6T-7221
	1 3/8	0.094	7J-0736
	1 1/2	0.125	1P-0620
	1 5/8	0.063	4N-5663
	1 3/4	0.125	1S-7592
	1 7/8	0.063	9F-1993
	2	0.094	2S-8398
	2 1/8	0.125	9T-2168
	2 1/4	0.156	8H-9488
	2 3/8	0.094	2J-0075
	2 1/2	0.125	7W-7700
	2 5/8	0.125	3V-5498
	2 3/4	0.094	8J-3819
	2 7/8	0.125	6L-2084
	3	0.094	4J-7066
	3 1/8	0.094	5J-3719
	3 1/4	0.094	8J-1705
	3 3/8	0.188	039-8820
	3 1/2	0.156	9T-1848
	3 3/4	0.094	5J-3419
	4	0.063	4B-4910
	4 1/8	0.063	1L-1098
	4 1/4	0.156	6L-4173
	4 1/2	0.156	9J-5002
	4 3/4	0.094	8J-6728
	4 7/8	0.125	5M-5526
	5	0.063	3L-4521
	5 1/4	0.094	8J-5839
	5 3/8	0.188	8M-1955
	5 1/2	0.188	6N-1320
	5 5/8	0.156	4M-0804
	6 1/8	0.156	2S-2760
	6 1/4	0.094	4F-6446
	6 1/2	0.125	6D-0314
6 7/8	0.125	5M-7884	

Springs / Extension

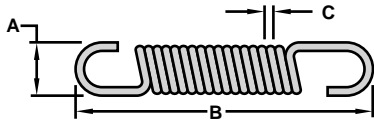

A OUTSIDE DIAMETER (in)	B LENGTH (in)	C WIRE DIAMETER (in)	PART NUMBER
5/16	1	0.094	039-9138
	1 1/4	0.035	7F-7613
	1 7/16	0.031	1A-3540
	1 11/16	0.031	3C-0481
	2 13/32	0.031	038-8415
3/8	1 1/2	0.063	1A-1376
	1 5/8	0.063	7L-4563
	4 9/32	0.047	5H-4291
1/2	1 1/4	0.063	8L-8491
	1 1/2	0.063	090-3006
	2	0.063	1A-0302
9/16	1 5/8	0.063	5M-9708
	4 1/4	0.063	2R-0416
5/8	1 3/8	0.063	9F-0965
	2 1/8	0.063	001-2809
	2 7/8	0.031	001-2810
	4	0.063	001-2811

A OUTSIDE DIAMETER (in)	B LENGTH (in)	C WIRE DIAMETER (in)	PART NUMBER
1 1/16	4	0.094	1D-1313
	6	0.094	7D-5289
3/4	2 5/32	0.063	1A-8189
25/32	3 3/4	0.094	1F-4449
7/8	2	0.094	2D-9871
	2 1/4	0.125	8L-5917
	3 1/8	0.125	5G-1684
	3 1/4	0.094	8Y-4581
	3 13/16	0.094	9S-1312
	4	0.125	7G-1251
1	4	0.094	009-2445
	5 1/8	0.094	035-7877
	5 3/8	0.156	038-2805
1 3/16	5 5/32	0.156	9P-9185
	5 3/8	0.125	091-7882
1 3/16	6 1/2	0.156	091-7881

Hardware

Hardware Bin Kits

Four different Hardware Bin Kits are available for customers who want to stock hardware bins for their service departments and/or service vehicles with various quantities of popular sizes of Cat bolts, nuts and washers. Kits available:

Part Number	Thread	Coating	Contains	Pieces
3E6640	Inch - Coarse	Phos. & Oil	59 Part Numbers	1735
3E9420	Inch - Coarse	Phos. & Oil	38 Part Numbers	1975
3E9421	Inch - Fine	Phos. & Oil	38 Part Numbers	1650
3E9422	Metric - Coarse	Phos. & Oil	38 Part Numbers	1580

Hardware Shop / Field Kits

Five different Hardware Shop / Field Kits are available for small repair shops or field service vehicles. Kits contain assortments of popular sizes of Cat bolts with matching washers and nuts, in phosphate and oil coatings. The hardware is packaged in a rugged metal box with hinged metal cover and latch. Inch Hardware Kits come in two sizes, small and large, depending on the quantity of hardware in the kit. Kits available:

Part Number	Thread	Coating	Size	Contains	Pieces
178-2207	Inch - Fine	Phos. & Oil	Large	24 Part Numbers	476
178-2208	Inch - Fine	Phos. & Oil	Small	29 Part Numbers	894
178-2209	Inch - Coarse	Phos. & Oil	Small	27 Part Numbers	502
178-2210	Inch - Coarse	Phos. & Oil	Large	34 Part Numbers	936
178-2211	Metric - Coarse	Phos. & Oil	Small	32 Part Numbers	630



LUBRICANTS

Oils	404
Special Application Lubricants	416
Grease	419
Brake Fluid	423



Cat Diesel Engine Oil (DEO™)

- Ensures optimum performance in Cat engines due to premium quality and conformance to Cat proprietary engine tests.
- Reduces piston ring groove deposits to minimize ring sticking.
- Controls soot build-up which can lead to filter plugging.
- Improves fuel and oil consumption.
- Exceeds API (American Petroleum Institute) test standards.
- Used as standard factory fill oil in Caterpillar facilities.
- For use in diesel, gasoline, and propane engines — including Caterpillar 3000, 3100, 3200, 3300, 3400, 3500, and D Series engines.

OIL TYPE	SAE OIL VISCOSITY	API / OEM SPECIFICATION	SIZE (gal)	SIZE (L)	PART NUMBER	
Cat Diesel Engine Oil (DEO™)	10W-30*	CF, CF-4, CG-4, SH	1		3E-9904	
			5		3E-9709	
			55		3E-9708	
			Bulk		155-6198	
				1	155-9013	
				4	3E-9846	
				5	3E-9845	
				20	3E-9844	
				25	3E-9843	
				200	130-7055	
				205	3E-9711	
				208	3E-9707	
		1200	8C-9910			
		Bulk	5P-2586			
		15W-40*	CF, CF-4, CG-4, CH-4, SJ	1		3E-9714
	5				3E-9713	
	55				3E-9712	
	Bulk				155-6199	
				1	123-4077	
				4	3E-9902	
				5	3E-9901	
				18	3E-9900	
				19	3E-9849	
				20	3E-9848	
	25			3E-9847		
	50			8C-6733		
	60	121-4038				
	200	3E-9842				
	205	3E-9841				
	208	3E-9840				
	209	3E-9839				

* Suitable for use in diesel and gasoline engines.

Note: Not all part numbers are available in all parts of the world. In general, English unit part numbers (gallons) are available for the United States or for U.S. export. Metric unit part numbers (liters) are available for countries outside the United States.

OIL TYPE	SAE OIL VISCOSITY	API / OEM SPECIFICATION	SIZE (gal)	SIZE (L)	PART NUMBER
Cat Diesel Engine Oil (DEO™) (cont.)	15W-40*	CF, CF-4, CG-4, CH-4, SJ		1000	3E-9838
				1040	201-0775
				1200	8C-9811
				2000	120-5285
				10000	119-5131
				15000	119-5130
				Bulk	8T-9548
	10W	CF		4	7X-7838
				20	7X-7837
				205	7X-7836
				208	109-0298
	30	CF	1		8C-3701
			5		8C-3700
			55		8C-3699
			Bulk		155-6201
				4	7X-7841
				5	9X-6178
				18	7X-7982
				19	9X-8462
				20	7X-7840
				25	9X-6179
				50	9X-6180
				60	121-4039
				200	7X-2887
				205	7X-7839
				208	9X-6462
				209	7X-7981
				1000	9X-6271
				1200	8C-9911
				Bulk	8C-3698
			40	CF	5
	55				8C-3704
	Bulk				155-6202
		1			123-4078
		4			7X-7844
		5			9X-6464
		18			9X-2004
		19			9X-8529
		20			7X-7843
		50			3E-8322
	60	121-4040			
	200	9X-8528			
	205	7X-7842			
	208	9X-6463			
	209	9X-2003			

* Suitable for use in diesel and gasoline engines.

Note: Not all part numbers are available in all parts of the world. In general, English unit part numbers (gallons) are available for the United States or for U.S. export. Metric unit part numbers (liters) are available for countries outside the United States.

Lubricants

OIL TYPE	SAE OIL VISCOSITY	API / OEM SPECIFICATION	SIZE (gal)	SIZE (L)	PART NUMBER
Cat Diesel Engine Oil (DEO™) (cont.)	40	CF		1000	9X-6272
				1200	203-1044
				2000	119-5134
				10000	119-5133
				15000	119-5132
				Bulk	8C-3703
Cat Special Application Engine Oil (SAEO™)*	30	CF, CF-4, SJ	1		170-5262
			5		198-7368
	40	CF, CF-4, SJ	1		170-5261
			5		198-7369

* Suitable for use in diesel and gasoline engines.

Note: Not all part numbers are available in all parts of the world. In general, English unit part numbers (gallons) are available for the United States or for U.S. export. Metric unit part numbers (liters) are available for countries outside the United States.



Cat Synthetic Diesel Engine Oil (DEO SYN™)

- Provides extended drain capability.
- Highly resistant to oxidation.
- Provides capability to improve fuel economy by 2-5% over conventional 15W40 oils.
- Provides exceptional cold start operation in temperatures as low as -22° F (-30° C).

OIL TYPE	SAE OIL VISCOSITY	API/OEM SPECIFICATION	SIZE		PART NUMBER
			(gal)	(L)	
Diesel Engine Oil - DEO 5W40 Synthetic**	5W-40	CF, CF-4, CG-4, CH-4, SJ	1		141-3339
			55		141-3341
			Bulk		155-6200
				Bulk	142-1417

* Suitable for use in diesel and gasoline engines.

Note: Not all part numbers are available in all parts of the world. In general, English unit part numbers (gallons) are available for the United States or for U.S. export. Metric unit part numbers (liters) are available for countries outside the United States.



Cat Natural Gas Engine Oil (NGEO™)

- Provides excellent valve guide face and seat protection.
- Provides maximum protection against piston scuffing, scoring, and piston/cylinder liner wear.
- Improves piston cleanliness and controls carbon deposits.
- Provides excellent foam and corrosion resistance.
- For use in all Caterpillar natural gas engines and any four-cycle, medium-to-high speed gas engine requiring a low ash level product.

OIL TYPE	SAE OIL VISCOSITY	SIZE		PART NUMBER
		(gal)	(L)	
Cat Natural Gas Engine Oil (NGEO™)	30	5		7X-2427
		55		7X-2461
		Bulk		155-6209
			19	121-0326
			20	109-0297
			205	9X-8526
			208	109-0296
			Bulk	7X-2425
	40	5		7X-2428
		55		7X-2469
		Bulk		155-6210
			5	105-3338
			19	121-0327
			20	105-3337
			200	197-6911
			205	9X-8527
			208	105-3336
			209	166-3491
			1000	159-8156
			Bulk	7X-2426

Note: Not all part numbers are available in all parts of the world. In general, English unit part numbers (gallons) are available for the United States or for U.S. export. Metric unit part numbers (liters) are available for countries outside the United States.



Cat Transmission and Drive Train Oil (TDTO™)

- Protects against scoring and pitting of gear teeth and bearings.
- Increases load carrying capacity of clutches and eliminates brake chatter.
- Provides maximum friction material life in power-shift transmissions and wet brakes.
- Exceeds the Cat TO-4 Industry Standard and meets Allison C-4 transmission performance requirements.
- Used as standard factory fill oil for transmissions in Caterpillar facilities.
- For use with all Cat transmission and brake disc materials.

OIL TYPE	SAE OIL VISCOSITY	API / OEM SPECIFICATION	SIZE (gal)	SIZE (L)	PART NUMBER	
Cat Transmission and Drive Train Oil (TDTO™)	10W	TO-4	1		8T-9567	
			5		8T-9568	
			55		8T-9569	
			Bulk		155-6212	
				4	7X-7853	
				5	100-7019	
				19	145-0995	
				20	7X-7852	
				25	9X-8525	
				60	121-4041	
				200	112-2866	
				205	7X-7851	
				208	103-2528	
				209	123-3104	
		1000	166-0393			
		1200	8C-9913			
		Bulk	3P-0659			
		30	TO-4	1		8T-9571
				5		8T-9572
				55		8T-9573
				Bulk		155-6213
					4	7X-7856
					5	9X-6467
					18	9X-2010
				19	9X-8469	
				20	7X-7855	
				25	9X-6175	
		50	3E-8323			
		60	121-4042			
		200	7X-2888			
		205	7X-7854			
		208	9X-6466			

Note: Not all part numbers are available in all parts of the world. In general, English unit part numbers (gallons) are available for the United States or for U.S. export. Metric unit part numbers (liters) are available for countries outside the United States.

Lubricants

OIL TYPE	SAE OIL VISCOSITY	API / OEM SPECIFICATION	SIZE (gal)	SIZE (L)	PART NUMBER
Cat Transmission and Drive Train Oil (TDTO™) (cont.)	30	TO-4		209	9X-2009
				1000	7X-7611
				1200	8C-9914
				2000	119-5137
				10000	119-5136
				15000	119-5135
				Bulk	2P-9869
	50	TO-4	1		8T-9575
			5		8T-9576
			55		8T-9577
			Bulk		155-6214
				4	7X-7859
				5	9X-8443
				18	9X-2012
				19	9X-8531
				20	7X-7858
				25	9X-6174
				50	3E-8324
				60	121-4043
				200	9X-8530
				205	7X-7857
				208	3E-9478
				209	9X-2011
				1000	7X-7612
				1200	8C-9925
				2000	119-5140
				10000	119-5139
	15000	119-5138			
	Bulk	5P-1228			

Note: Not all part numbers are available in all parts of the world. In general, English unit part numbers (gallons) are available for the United States or for U.S. export. Metric unit part numbers (liters) are available for countries outside the United States.



Cat Transmission and Drive Train Oil (TDTO-TMS™)

- Operates over a wider temperature range than standard TDTO.
- Improves transmission performance in cold weather.
- Provides extended drain capability.
- Compatible for use in multiple compartments.
- For use in all seasons.

OIL TYPE	SAE OIL VISCOSITY	API/OEM SPECIFICATION	SIZE		PART NUMBER
			(gal)	(L)	
Cat Transmission and Drive Train Oil (TDTO-TMS™)	Multi-Vis	TO-4M	5		154-0195
			55		154-0194
			Bulk		154-0192
				20	154-0196
				208	154-0197
				Bulk	154-0193

Note: Not all part numbers are available in all parts of the world. In general, English unit part numbers (gallons) are available for the United States or for U.S. export. Metric unit part numbers (liters) are available for countries outside the United States.



Cat Multipurpose Tractor Oil (MTO)

- Provides considerable improvement in wet brake control.
- Meets Ford spec M2C134 D/C.
- For use in specified Cat components and systems — such as Backhoe Loader Rear Axles, Compactors CP563 and CS563 Rear Axles, and Challenger Tractor hydraulics and steering systems.

OIL TYPE	SAE OIL VISCOSITY	API/OEM SPECIFICATION	SIZE		PART NUMBER
			(gal)	(L)	
Cat Multipurpose Tractor Oil (MTO)	10W-30	FORD M2C134D/C, JOHN DEERE J20A/C, CASE MS1205, MS1207	5		105-3335
			55		105-3334
			Bulk		155-6218
				5	172-6894
				18	135-3189
				19	112-9183
				20	109-4395
				200	126-2700
				205	138-4271
				208	120-5286
				Bulk	105-3333

Note: Not all part numbers are available in all parts of the world. In general, English unit part numbers (gallons) are available for the United States or for U.S. export. Metric unit part numbers (liters) are available for countries outside the United States.



Cat Final Drive and Axle Oil (FDAO™)

- Specially formulated for the final drives and differentials of Caterpillar off-highway trucks, D6 - D11 tractors and selected other machine models.
- Provides greater protection against pitting and scoring of gear teeth and bearings than Transmission/Drive Train Oil.
- Not to be used in compartments which contain brake or friction materials unless specified in the Operational & Maintenance Instructions.
- Not to be used in compartments in which GL-5 Gear oils are required.
- Designed for protection of highly loaded gears and bearings.
- Used as factory fill for all Cat off-highway trucks and D6R - D11R tractor final drives.

OIL TYPE	SAE OIL VISCOSITY	API/OEM SPECIFICATION	SIZE		PART NUMBER	
			(gal)	(L)		
Cat Final Drive and Axle Oil (FDAO™)	50		5		184-6025	
			55		184-6024	
			Bulk		184-6023	
				18	206-5209	
				20	184-8052	
				200	198-7671	
				205	201-9854	
				208	184-8053	
				1200	202-9752	
				Bulk	184-8051	
	60			5		184-6022
				55		184-6021
				Bulk		184-6020
					18	206-5210
					20	184-8055
					200	198-7672
					205	201-9855
					208	184-8056
					1200	202-9753
					Bulk	184-8054

Note: Not all part numbers are available in all parts of the world. In general, English unit part numbers (gallons) are available for the United States or for U.S. export. Metric unit part numbers (liters) are available for countries outside the United States.

Cat Final Drive and Axle Oil Synthetic (FDAO Syn™)

- For Off-Highway Trucks and Track-Type Tractors subjected to severe operating conditions in which mineral oil-based final drive lubricants experience high rates of oxidation and resultant short life.
- Provides extended life capability when S-O-S Analysis is employed at 500 hour intervals.
- Not for use in compartments in which GL-5 Gear Oils are required.
- Not for use in compartments that contain brake or friction materials.

OIL TYPE	SAE OIL VISCOSITY	API/OEM SPECIFICATION	SIZE		PART NUMBER
			(gal)	(L)	
Cat Final Drive and Axle Oil Synthetic (FDAO Syn™)	Multi-Vis	FD-1	5		208-2390
			55		198-7450
				18	206-5211
				208	206-5212

Note: Not all part numbers are available in all parts of the world. In general, English unit part numbers (gallons) are available for the United States or for U.S. export. Metric unit part numbers (liters) are available for countries outside the United States.

Lubricants



Cat Hydraulic Oil (HYDO™)

- Provides maximum protection against mechanical wear, low temperature rusting, and corrosive wear.
- Additive system contains superior metallic detergents, rust inhibitors, antiwear agents, and defoamants.
- Exceeds minimum zinc additive requirement needed for lubrication of pumps, motors, and valves.
- Disperses water in the hydraulic oils, preventing water damage to pumps, motors, and valves.
- Used as factory fill oil in Caterpillar facilities.
- For use in all hydraulic systems and hydrostatic transmissions.

OIL TYPE	SAE OIL VISCOSITY	SIZE		PART NUMBER	
		(gal)	(L)		
Cat Hydraulic Oil (HYDO™)	10W	1		8T-9579	
		5		8T-9580	
		55		8T-9581	
		Bulk		155-6216	
			4	7X-7862	
			5	9X-6171	
			18	9X-2014	
			19	9X-8533	
			20	7X-7861	
			25	9X-6172	
			50	9X-6173	
			60	121-4044	
			200	9X-8532	
			205	7X-7860	
			208	9X-6468	
			209	9X-2013	
			1000	7X-7613	
		1040	201-0776		
		1200	8C-9926		
		2000	119-5143		
		10000	119-5142		
		15000	119-5141		
		Bulk	2P-9063		
		30		18	100-7017
				20	127-5454
				200	122-6627
				208	127-5453
			209	100-7018	

Note: Not all part numbers are available in all parts of the world. In general, English unit part numbers (gallons) are available for the United States or for U.S. export. Metric unit part numbers (liters) are available for countries outside the United States.



Cat Gear Oil (GO)

- Provides excellent stability under high temperatures and superior performance under low temperature.
- Protects against rust and corrosion.
- Protects against scoring and pitting of gear teeth and rolling element bearings.
- Includes EP “Extreme Pressure” additive.
- For use in manual transmissions, axles, final drives, and systems requiring API GL-5 oil.
- For use in the vibrator drum of soil compactors.

OIL TYPE	SAE OIL VISCOSITY	API/OEM SPECIFICATION	SIZE		PART NUMBER	
			(gal)	(L)		
Cat Gear Oil (GO)	80W90	GL-5	5		8T-9582 ^③	
			15		8C-7398 ^②	
			30		8T-9583	
			55		8T-9584 ^①	
			Bulk		155-6220	
				4	7X-7868	
				5	9X-6470	
				18	9X-2016	
				19	9X-8535	
				20	7X-7867	
				25	9X-6170	
				50	3E-8325	
				60	7X-7887	
		200	9X-8534			
		205	7X-7866			
		208	9X-6469			
		209	9X-2015			
		1000	119-5129			
		1200	8C-9927			
		2000	119-5144			
		Bulk	2P-9863			
		85W140	GL-5	1		165-9046
				5		9X-6185 ^③
					4	7X-7618
					18	133-9643
					20	7X-7617
				50	3E-8326	
				200	205-4312	
				205	7X-7616	
				208	161-1246	
				209	133-9644	
				1000	7X-7615	
				Bulk	7X-7614	

① - Drum = 55 gal = 400 lbs

② - Keg = 15 gal = 120 lbs

③ - Pail = 5 gal = 38 lbs

Note: Not all part numbers are available in all parts of the world. In general, English unit part numbers (gallons) are available for the United States or for U.S. export. Metric unit part numbers (liters) are available for countries outside the United States.

Lubricants



Synthetic Gear Oil (GO)

- For use in the vibrator drum of asphalt compactors.

OIL TYPE	SAE OIL VISCOSITY	SIZE		PART NUMBER
		(gal)	(L)	
Synthetic Gear Oil (GO)	—	5		4C-6767



Cat Axle and Brake Oil Additive

- For the rear axle housing of Cat backhoe loaders.
- Reduces noise and chatter experienced by some Cat backhoe loaders.
- Do not use in any other axle, brake or hydraulic system.

ITEM	SAE OIL VISCOSITY	SIZE		PART NUMBER
		(gal)	(L)	
Cat Axle and Brake Oil Additive	—	0.250 (1 qt)	0.946	197-0017



Rubber Lubricant

- Helps stop rim corrosion and bead surface damage during tire repair.
- Helps renew appearance of rubber, vinyl, and leather.

ITEM	SIZE	SIZE	PART NUMBER
	(oz.)	(gal)	
Rubber Lubricant		1	5P-3975



Bearing Lubricant

- Services ball and roller bearings which operate at high speeds and temperatures: -30° F to 325° F (-34° C to 163° C).
- Assures good lubrication and maximum bearing service life.
- For use with high temperature anti-friction bearings in applications such as electric motors, alternators, fan drives, starters, and generators.

ITEM	SIZE (oz.)	SIZE (gal)	PART NUMBER
Bearing Lubricant	14.50 (Cartridge)		2S-3230



Camshaft Break-In Lubricant

- Helps prevent galling on camshaft lobes during the critical start-up cycle.

ITEM	SIZE (oz.)	SIZE (gal)	PART NUMBER
Camshaft Break-In Lubricant	8.00		8T-2998



Silicone Lubricant

- For use with flexible coupling rubber boots or as a general rubber lubricant.

ITEM	SIZE (oz.)	SIZE (gal)	PART NUMBER
Silicone Lubricant	12.00		5N-5561

Lubricants



Molykote Paste Lubricant

- Helps prevent bushing to thrust ring galling on D9L and D10 Track-Type Tractors.

ITEM	SIZE (oz.)	SIZE (gal)	PART NUMBER
Molykote Paste Lubricant	17.60 (Cartridge)		6V-4876



Chain and Cable Lubricant

- Prevents wear and corrosion, extending service life.
- Provides quick and easy temporary rust protection for any metal part.
- For use with chains, cables, and hinges.

ITEM	SIZE (oz.)	SIZE (gal)	PART NUMBER
Chain and Cable Lubricant	13.00 (Aerosol)		1U-8266
		5 (Plastic Pail)	4C-4081



Dry Film Lubricant

- Provides a dry, low friction lubricant that does not attract dirt or dust.
- For use with sliding surfaces, such as Motor Grader blade circles and Backhoe Loader sideshift mechanisms.

ITEM	SIZE (oz.)	SIZE (gal)	PART NUMBER
Dry Film Lubricant	13.00 (Aerosol)		1U-8268



High Vacuum Grease

- For use in the seal ring groove at the turbine end of the turbocharger wheel and shaft assembly.

ITEM	SIZE (oz.)	SIZE (gal)	PART NUMBER
High Vacuum Grease	5.30		6V-2055



Dielectric Tune-Up Grease

- Prevents fusing of spark plug boots, arcing, voltage leaks, and corrosion in electrical connections.

ITEM	SIZE (oz.)	SIZE (gal)	PART NUMBER
Dielectric Tune-Up Grease	0.20		8T-9020

Lubricants



Multipurpose Lithium Grease - MPGM

- Contains 3% or 5% molybdenum disulfide.
- For use in a wide range of operating temperatures: -18° F to 300° F (-28° C to 149° C).
- For use with heavily loaded bearings and joints requiring an extreme pressure grease.

ITEM	SIZE (oz.)	SIZE (gal)	PART NUMBER
Multi. Lithium Grease NLGI Grd. 0 - MPGM (5% MoS ²)		5 (Metal Pail)	129-1961
		5 (Plastic Pail)	129-1960
		15	129-1962
		55	129-1963
		Bulk	129-1965
Multi. Lithium Grease NLGI Grd. 2 - MPGM (3% MoS ²)	16.00 (Can)		129-1922
	14.50 (Cartridge)		5P-0960
		5 (Metal Pail)	129-1924
		5 (Plastic Pail)	7X-7699
		15	9X-6489
		55	7X-7701
		Bulk	129-1926



Multipurpose Lithium Grease - MPG

- For use with light duty automotive type applications requiring a high temperature grease (350° F, 175° C).

ITEM	SIZE (oz.)	SIZE (gal)	PART NUMBER
Multipurpose Lithium Grease NLGI Grade 2 - MPC	16.00 (Can)		129-1916
	14.50 (Cartridge)		1P-0808
		5 (Metal Pail)	129-1919
		5 (Plastic Pail)	7X-7664
		15	9X-6488
		55	7X-7665
		Bulk	129-1921



White Lithium Assembly Grease

- Provides an extra tacky hold for assembly products such as needle bearings and gaskets.
- For use in general purpose lubrication applications.

ITEM	SIZE (oz.)	SIZE (gal)	PART NUMBER
White Lithium Assembly Grease NLGI Grade 2	13.00 (Aerosol)		129-1968
	16.00 (Can)		129-1967
	16.00 (Cartridge)		129-1966
		5 (Metal Pail)	129-1970
		5 (Plastic Pail)	129-1969
		15	129-1971
		55	129-1973
		Bulk	129-1975



Water and Temperature Resistant Grease

- Maintains exceptional water and temperature resistance.
- Meets ASTM D-1264 Water Washout Test.
- For moderately loaded machines that work in wet conditions.

ITEM	SIZE (oz.)	SIZE (gal)	PART NUMBER
Water and Temperature Resistant Grease NLGI Grade 1	8.00		4C-9792
	16.00 (Cartridge)		4C-9793
		5 (Metal Pail)	4C-9794
		15	4C-9795
		55	4C-9796
	Water and Temperature Resistant Grease NLGI Grade 2	8.00	
13.00 (Aerosol)			129-1949
16.00 (Can)			129-1948
16.00 (Cartridge)			4C-4774
		5 (Metal Pail)	129-1951
		5 (Plastic Pail)	4C-5594
		15	4C-5595
		55	4C-5596
		Bulk	129-1955

Lubricants



Desert Gold Grease

- Extra tacky to stick to open gears and bearings.
- Contains 5% molybdenum disulfide for extra high loads.
- For use in heavily loaded joints where temperatures can be as high as 400° F (204° C).
- For use in central lube systems on large mining vehicles.
- Very water resistant.
- Longer lasting than regular MPGM greases.

ITEM	SIZE (oz.)	SIZE (gal)	PART NUMBER
Desert Gold NLGI Grade 2	16.00 (Can)		129-1939
	16.00 (Cartridge)		129-1938
		5 (Metal Pail)	129-1942
		5 (Plastic Pail)	129-1941
		15	129-1943
		55	129-1944
		Bulk	129-1946



Arctic Platinum Grease

- Provides an extra tacky hold to stick to open gears and bearings.
- Contains 5% molybdenum disulfide for extra high loads.
- For use in heavily loaded joints where temperatures can be as low as -65° F (-54° C).
- For use in central lube systems on large mining vehicles.
- Exceptional water resistance.
- Exceptional resistance to breakdown from mechanical working.

ITEM	SIZE (oz.)	SIZE (gal)	PART NUMBER
Arctic Platinum NLGI Grade 0		5 (Metal Pail)	129-8707
		5 (Plastic Pail)	129-8708
		15	129-8709
		55	129-8710
		Bulk	129-8711
Arctic Platinum NLGI Grade 00		5 (Metal Pail)	129-8716
		5 (Plastic Pail)	129-8717
		15	129-8718
		55	129-8719
		Bulk	129-8720

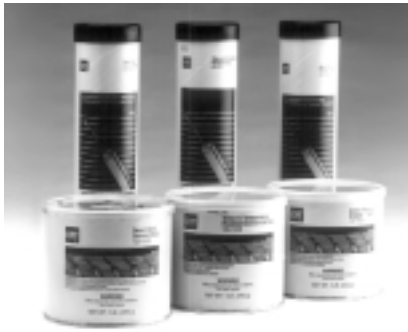

Auto-Lube Grease #1

- Environmentally friendly, with no additives such as lead, antimony, zinc, barium, chlorine and no sulfur or phosphorous.
- Provides excellent pumpability and dispersing properties in ambient temperatures.
- Exceptional water resistance.
- Exceptional resistance to breakdown from mechanical working.

ITEM	SIZE (oz.)	SIZE (gal)	PART NUMBER
Auto-Lube Grease #1	16.00		161-9203
		15	161-0970
		55	161-0971
		Bulk	160-8028



Brake Fluid

- DOT 3 is for use where brake fluid is specified by the service manual or operators guide — such as Loaders, Lift Trucks, or Service Trucks.
- DOT 5 is for use in extreme service conditions where higher than normal temperatures are encountered or where moisture absorption is a problem. DOT 5 is used for high performance cars or off-road vehicles.

ITEM	SIZE (oz.)	SIZE (gal)	PART NUMBER
Brake Fluid DOT 3		0.250 (1 qt)	4C-5585
		1	4C-5586
Brake Fluid DOT 5		0.250 (1 qt)	4C-5588
		1	4C-5589



OPERATOR CONVENIENCES

Digital Tachometers	426
Service Meters	427
Signals, Alarms and Horns	429
Mud Flaps	430
Windshield Wipers	431
Control Knobs and Fuel Water Separator	432
Contour Series Seats	433
Radios	434
Orange Hand Cleaner and Master Padlocks	435

Operator Conveniences



Digital Tachometers

ITEM	NUMBER OF RING GEAR TEETH	PROGRAMMING BOARD*	PART NUMBER
Digital Tachometer	84	3T-2164	9X-1117
Digital Tachometer	113	3T-2160	9X-1117
Digital Tachometer	126	3T-2163	9X-1117
Digital Tachometer	132	3T-2162	9X-1117
Digital Tachometer	134	3T-2161	9X-1117
Digital Tachometer	136	3T-2161	9X-1117
Digital Tachometer	151	3T-2162	9X-1117
Digital Tachometer	156	3T-2163	9X-1117
Digital Tachometer	183	3T-2164	9X-1117
Digital Tachometer	255	3T-2162	9X-1114
Digital Tachometer (Lighted)	84	3T-2164	9X-1116
Digital Tachometer (Lighted)	113	3T-2160	9X-1116
Digital Tachometer (Lighted)	126	3T-2163	9X-1116
Digital Tachometer (Lighted)	132	3T-2162	9X-1116
Digital Tachometer (Lighted)	134	3T-2161	9X-1116
Digital Tachometer (Lighted)	136	3T-2161	9X-1116
Digital Tachometer (Lighted)	151	3T-2162	9X-1116
Digital Tachometer (Lighted)	156	3T-2163	9X-1116
Digital Tachometer (Lighted)	183	3T-2164	9X-1116
$\frac{5}{8}$ -18 UNF Thread Pick-Up			3E-7126
$\frac{3}{4}$ -16 UNF Thread Pick-Up			2W-8918

* Programming boards allow the digital tachometer to function with ring gears that have several different quantities of teeth.



Service Meters

ITEM	MODEL	SERIAL NUMBER	PART NUMBER
Electronic Service Meter (Machine)	All except D3, D9L, D10, 910, 931		9W-1491
	D3, 910, 931		9W-1493
	D9L, D10		9W-1495
Electronic Service Meter (Engine)	D330C (Industrial, Naturally Aspirated)	2B3686	9S-8722
	D330C (Industrial, Turbocharged)	4B4822	9S-8722
	D330C (Marine, Turbocharged)	5B982	9S-8722
	D333C (Industrial, Naturally Aspirated)	23C722	9S-8722
	D333C (Industrial, Turbocharged)	66D6728	9S-8722
	D334 (Industrial, Turbocharged-Aftercooler)	92B1	6L-4420
	D334 (Marine, Turbocharged-Aftercooler)	93B1	6L-4420
	D342C (Industrial, Naturally Aspirated)	31B2191	7L-4855
	D342C (Marine, Naturally Aspirated)	32B1332	7L-4855
	D342C (Industrial, Turbocharged)	49B1	7L-4855
	D342C (Marine, Turbocharged)	50B1	7L-4855
	D343A (Marine, Turbocharged-Aftercooler)	33B3028	8S-3687
	D343A (Industrial, Turbocharged-Aftercooler)	62B6728	8S-3687
	D346 (Industrial, Turbocharged-Aftercooler)	39J413	1P-6395
	D346 (Marine, Turbocharged-Aftercooler)	40J246	8S-3687
	D346 (Off-Highway Truck, Turbocharged-Aftercooler)	98N1	1P-6395
	D348 (Industrial, Turbocharged-Aftercooler)	36J363	1P-6395
	D348 (Marine, Turbocharged-Aftercooler)	38J193	8S-3687
	D348 (Off-Highway Truck, Turbocharged-Aftercooler)	58K367	8S-3687
	D349 (Industrial, Turbocharged-Aftercooler)	61P1	1P-6395
	D349 (Marine, Turbocharged-Aftercooler)	62P1	8S-3687
	D349 (Off-Highway Truck, Turbocharged-Aftercooler)	93B1	8S-3687
	D353D/E (Industrial, Turbocharged)	46B903	6L-9354
	D353D/E (Marine, Turbocharged-Aftercooler)	47B485	6L-9354
	D379A/B (Industrial, Turbocharged)	68B2305	2N-8378
	D379A/B (Marine, Turbocharged-Aftercooler)	69B1113	2N-8378
	D398 (Industrial, Turbocharged-Aftercooler)	66B3145	2N-8378
	D398 (Marine, Turbocharged-Aftercooler)	67B1253	2N-8378
	D398A (Industrial, Turbocharged-Aftercooler)	2N8378	2N-8378
	D399 (Industrial, Turbocharged-Aftercooler)	35B505	2N-8378
	D399 (Marine, Turbocharged-Aftercooler)	91B331	2N-8378
	G333C (Industrial, Naturally Aspirated Spark Ignited)	67D852	9S-8722
	G342C (Industrial, Naturally Aspirated Spark Ignited)	71B1	7L-4855
G343 (Industrial, Turbocharged-Aftercooler)	47N1	3S-7229	

Operator Conveniences

Service Meters

ITEM	MODEL	SERIAL NUMBER	PART NUMBER
Electronic Service Meter (Engine)	G346 (Industrial, Turbocharged-Aftercooler)	91B1	1P-6395
	G348 (Industrial, Turbocharged-Aftercooler)	92B1	1P-6395
	G349 (Industrial, Turbocharged-Aftercooler)	32R1	1P-6395
	G353D (Industrial, Naturally Aspirated Spark Ignited)	64B1	5S-1391
	G379A (Industrial, Naturally Aspirated Spark Ignited)	72B409	2N-8378
	G399 (Industrial, Turbocharged-Aftercooler)	49C176	2N-8378
Self-Powered Service Meter	(⁵ / ₈ -18 UNF Thread Pick-Up)		9W-1494

Operator Conveniences



Signals

ITEM	SIZE		PART NUMBER
	(in)	(mm)	
Beacon			6T-8941
Reflector (Red)	3 5/8" x 4 1/2"	92 x 114	7L-6363
Turn Signal Flasher			108-0358

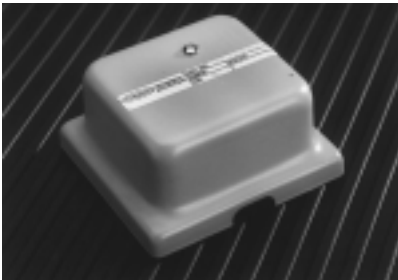

Alarms

ITEM	VOLTAGE	PART NUMBER
Back-up Alarm	12 or 24	3T-1815
Excavator Travel Alarm		9P-1813
Low Air Pressure Alarm (Off-Highway Trucks)	12	8M-0479
Low Air Pressure Alarm (Off-Highway Trucks)	24	9M-8067
Low Air Pressure Alarm (Articulated Trucks, Wheel Loaders, Wheel Tractors)	24	7K-8924



Horns

ITEM	VOLTAGE	PART NUMBER
Air Horn		5D-6998
Forward Warning Horn (Low Tone)	12	7T-0635
Forward Warning Horn (Low Tone)	24	7T-0969
Forward Warning Horn (High Tone)	12	109-4575
Forward Warning Horn (High Tone)	24	7T-0970

Operator Conveniences



Mud Flaps

- Reduce water spray.

ITEM	MODEL	SIZE		PART NUMBER
		(in)	(mm)	
Cat Diesel Power Mud Flap (Black With Yellow Lettering)	613, 613B, 613C	24 x 33.5	609 x 846	9J-9125
Cat Diesel Power Mud Flap (Black With Yellow Lettering)	615, 615C	30 x 40.5	762 x 1028	9J-7485
Cat Mud Flap (Black With Yellow Lettering)	On-Highway Trucks	12 x 18	304 x 457	9U-7309
Cat Mud Flap (Black With Yellow Lettering)	On-Highway Trucks	20 x 14	508 x 353	9U-7310
Cat Diesel Power Mud Flap (White With Black Lettering)	On-Highway Trucks	24 x 14	610 x 355	7X-2983
Cat Diesel Power Mud Flap (Black With Yellow Lettering)	On-Highway Trucks	24 x 30	610 x 762	154-6563
Cat Diesel Power Mud Flap (White With Black Lettering)	On-Highway Trucks	24 x 36	610 x 914	7X-2984
Cat Diesel Power Mud Flap (White With Black Lettering)	On-Highway Trucks	24 x 36	610 x 914	7X-2985
Cat Diesel Power Mud Flap (Black With Yellow Lettering)	On-Highway Trucks	24 x 14	610 x 355	7X-2982
Cat Diesel Power Mud Flap (Black With Yellow Lettering)	On-Highway Trucks	24 x 30	610 x 762	154-6564
Cat Diesel Power Mud Flap (Black With Yellow Lettering)	On-Highway Trucks	24 x 36	610 x 914	7X-2986
Spray Guard Rain Flap	On-Highway Trucks	24 x 30	610 x 762	154-8873
Spray Guard Rain Flap	On-Highway Trucks	24 x 36	610 x 914	6V-3351
Spray Guard Rain Flap Skirt	On-Highway Trucks	6 x 48	152 x 1219	6V-3352
Black Rubber Fiber Mud Flap	Pickups, Campers, Trailers, Vans	24 x 14	610 x 355	5P-0774
Black Rubber Fiber Mud Flap	613	24 x 14	610 x 355	9J-0108
Black Rubber Fiber Mud Flap	627	24 x 14	610 x 355	8J-2961
Black Rubber Fiber Mud Flap	631B, 631C	24 x 14	610 x 355	7J-6214
Black Rubber Fiber Mud Flap	988B, 988F, 988G	24 x 14	610 x 355	8J-2962
Black Rubber Fiber Mud Flap	785, 785B, 785C, 789C, 793B, 793C	24 x 23.5	612 x 600	105-4727
Black Rubber Fiber Mud Flap	Large On-Highway Trucks	24 x 36	610 x 914	2P-8549
Black Rubber Fiber Mud Flap	D250E, D300E, D350E	27.5 x 24	695 x 610	130-3130
Black Rubber Fiber Mud Flap	777, 777B, 777C, 777D	38 x 48	965 x 1220	6G-3361
Black Rubber Fiber Mud Flap	777, 777B, 777C, 777D, 785C	48 x 12	1225 x 300	8W-6062
Black Rubber Fiber Mud Flap	785, 785C	49 x 13	1250 x 330	5T-5987
Black Rubber Fiber Mud Flap	785, 785C	49 x 34.5	1250 x 872	5T-5986
Black Rubber Fiber Mud Flap	797	58.5 x 39.5	1490 x 1000	153-7963
Black Rubber Fiber Mud Flap	785, 785C, 789, 789C	60 x 18	1524 x 453	5T-5988
Black Rubber Fiber Mud Flap	785, 785C, 789, 789C	60 x 39.5	1524 x 1003	5T-5989
Black Rubber Fiber Mud Flap	793B, 793C	67 x 10	1700 x 250	8X-5064
Black Rubber Fiber Mud Flap	789, 789C, 793B, 793C, 797	70.5 x 20.5	1790 x 520	5T-7275
Black Rubber Fiber Mud Flap	793B, 793C	70.5 x 23.5	1790 x 600	8X-5063
Black Rubber Fiber Mud Flap	789, 789C, 793B, 793C, 797	70.5 x 39.5	1790 x 1000	5T-7274
White Anti-Sail Mud Flap	Pickups, Campers, Trailers, Vans	24 x 14	610 x 355	6V-1474
White Anti-Sail Mud Flap	Large On-Highway Trucks	24 x 36	610 x 914	6V-1449

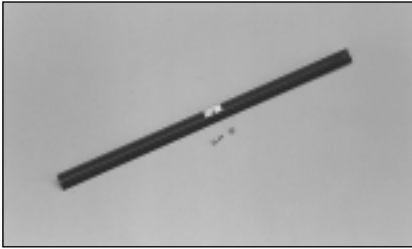

Windshield Wipers

ITEM	VOLTAGE	WIPE ANGLE	LENGTH		PART NUMBER
			(in)	(mm)	
Windshield Wiper Blade			10.24	260	6V-8255
Windshield Wiper Blade			12.90	330	123-4355
Windshield Wiper Blade			12.90	330	128-5040
Windshield Wiper Blade			15.75	400	6V-5851
Windshield Wiper Blade			17.72	450	6V-5853
Windshield Wiper Blade			17.70	450	4I-6839
Windshield Wiper Blade			19.68	500	5C-8811
Windshield Wiper Blade			19.80	503	6V-6543
Windshield Wiper Blade			20.00	508	8T-6450
Windshield Wiper Blade (No Blade Holder)			22.00	559	2V-2248
Windshield Wiper Blade			22.00	560	6W-3924
Windshield Wiper Blade			23.62	600	5C-8813
Windshield Wiper Blade			23.62	600	6V-6864
Windshield Wiper Blade			27.56	700	6V-7419
Windshield Wiper Blade (No Blade Holder)			8.00	203	4K-0353
Windshield Wiper Blade			9.00	229	5P-5376*
Windshield Wiper Blade			10.00	254	5P-5345*
Windshield Wiper Blade			11.00	279	5P-5377*
Windshield Wiper Blade			12.00	305	5P-5378*
Windshield Wiper Blade			14.00	356	9D-1242*
Windshield Wiper Blade (No Blade Holder)			16.00	406	8K-6289
Windshield Wiper Blade (No Blade Holder)			18.00	457	4K-1077
Windshield Wiper Blade (No Blade Holder)			20.00	508	5K-1028
Windshield Wiper Group	12	55°	1.00	25	7T-1033
Windshield Wiper Group	12	68°	1.00	25	7T-1032
Windshield Wiper Group	24	55°	1.00	25	6T-7293
Windshield Wiper Group	24	55°	3.00	76	6T-7249
Windshield Wiper Group	24	68°	1.00	25	6T-7295
Windshield Wiper Group	24	68°	2.00	51	6T-7296
Windshield Wiper Group	24	85°	1.00	25	6T-7297
Windshield Wiper Group	24	85°	2.00	51	6T-7299
Windshield Wiper Group	24	93°	2.00	51	6T-7300
Windshield Wiper Group	24	108°	1.00	25	6T-7301
Windshield Wiper Group	24	108°	2.00	51	6T-7302

* Wiper Arm included

Operator Conveniences

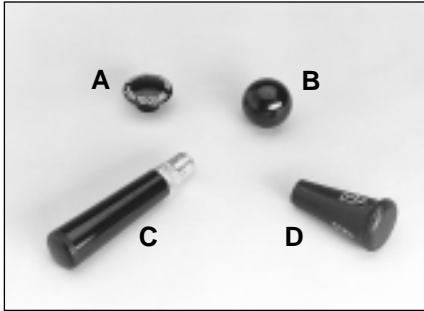

Control Knobs

ITEM	SHAPE	THREAD SIZE (in - TPI)	THREAD SIZE (dia x pitch)	HEIGHT (in)	HEIGHT (mm)	PART NUMBER
Spinner Knob	—	—	—	2.12	54	2K-9096
Brake Control Knob	A	1/4-28		1.00	25	9K-6765
Choke Knob	A	1/4-28		0.81	21	1H-4936
Choke Knob	A	1/4-28		0.88	22	5H-2624
Choke Knob	A	1/4-28		1.00	25	6P-0863
Choke Knob	A	1/4-20		1.00	25	6P-0863
Choke Knob	A	1/4-28		1.77	45	3P-4570
Choke Knob	A	1/4-20		1.77	45	3P-4570
Fuel Knob	A	1/4-28		0.81	21	4K-4597
Fuel Knob	A	1/4-28		0.88	22	1S-1310
Temperature Control Knob	A		6.4	0.63	16	1P-6509
Temperature Control Knob	A		6.4	0.75	19	2V-0099
Throttle Knob	A	1/4-28		0.81	21	1H-4937
Throttle Knob	A	1/4-28		0.88	22	5H-2625
Brake Control	A		9.0	1.17	30	9C-3408
Gearshift Knob	A	3/8-24		1.56	40	0L-1170
Gearshift Knob	B	3/8-24		1.50	38	6D-0679
Ball Knob	B		M12 x 1.75	1.30	33	8T-3984
Gearshift Knob	B	1/2-20		1.88	48	2A-1736
Ball Knob	B		M16 x 2.00	1.57	40	8T-9000
Gearshift Knob	C	3/8-24		2.50	64	7M-0706
Gearshift Knob	C		9.8	3.80	97	4N-4523
Control Knob	C	7/16-20		4.87	124	1K-2880
Control Knob	C	1/2-20		4.87	124	0L-0829
Safety Knob	D	3/8-16		3.00	71	2M-8908



Fuel Water Separator

- Helps protect engines against water-contaminated fuel which can cause internal wear and corrosion of vital components.

ITEM	WATER CAPACITY BEFORE DRAINING (oz)	WATER CAPACITY BEFORE DRAINING (ml)	MAXIMUM FUEL FLOW RATE (gal)	MAXIMUM FUEL FLOW RATE (L)	PART NUMBER
Fuel Water Separator (Standard Capacity)	6.4	189	33	125	9N-6519
Fuel Water Separator (High Capacity)	34.0	1000	300	1135	8N-0940



Caterpillar Contour Series Seats

Caterpillar Comfort Series Seats have been designed to provide you the most comfortable support and durability available on any earthmoving equipment. Durable, heavy-duty construction and contoured cushions assure you of continuing satisfaction and a comfortable, less tiring ride.

- Reduce pressure on the thighs due to a rolled down front edge of the seat cushion.
- Provide additional comfort due to an adjustable tilt angle feature on the seat cushion.
- Restrain side-to-side movement when operating on side slopes and rough terrain due to seat cushion side bolsters.
- Provide additional side-to-side support due to back cushion bolsters.
- Provide back cushions that conform to operator's spinal curve for good support and comfort.
- Adjust ergonomically designed lumbar support for added comfort.
- Provide a durable dual-locking backrest structure that is adjustable up to 30 degree recline (up to 45 degrees on some models).
- Provide additional upper back support due to a backrest extension.
- Adjust armrest to the most comfortable position, or flip up the armrest when not desired.
- Allow unrestricted arm movement due to a narrowing backrest.
- Offer superior suspension performance using both air and mechanical suspension versions.
- Contain a 3" wide automatic locking retractor seat belt, which has anti-cinching features.

MODEL *	MATERIAL	VAR. DAMP	LEFT ARMREST	RIGHT ARMREST	SEAT** PART NUMBER	SUSPENSION PART NUMBER
769-793	Fabric-Gray	Yes	Short	Short-Adjust	186-3051	169-8716
797	Fabric-Gray	Yes	Short	Short	186-3049	169-8716
D350-D400	Fabric-Gray	Yes	Short	Short	187-4295	169-7034
621-637	Fabric-Gray	Yes	Short	Short	177-3255	
D4-D11, 988, 834	Fabric-Gray	No	None	None	178-0606	161-7539
D4-D11	Fabric-Brown	No	None	None	184-6012	161-7539
D4-D11	Vinyl	No	None	None	159-2950	
D4-D11	Fabric-Gray	No	None	None	160-7186	
D4-D11	Fabric-Brown	No	None	None	159-2951	
990-994, 844-854	Fabric-Gray	No	None	None	185-9726	161-7539
836 Steering Wheel	Fabric-Gray	No	Wide	None	180-9851	161-7539
950-980	Fabric-Gray	No	Wide	Controls	187-0821	172-9444
950-980, 824-826	Vinyl	No	Wide	Controls	210-2113	172-9444
824-826	Fabric-Gray	No	Wide	Controls	187-0821	161-7539

* For models manufactured after 1980 and containing Caterpillar Corporate Seats, mounting dimensions and space requirements are identical to those required for the new Contour Series Seat.

** The seat part numbers that have a suspension part number listed in the adjacent column indicate air suspension, this part number along with 173-7035 Block Kit needs to be ordered for a complete seat-suspension system.

Operator Conveniences



Radios

Caterpillar radios are made specifically for earthmoving applications. They exceed industry standards and pass Caterpillar's strict engineering tests.

- Designed to withstand vibration and shock loads.
- Equipped with a fixed DIN mounting bracket.
- Equipped with custom designed knobs for easy handling with gloves or arctic mittens.
- Equipped with a wiring harness and Cat connector.
- Equipped with LED backlighting for greater visibility.

Caterpillar also offers a radio installation kit to install a radio system in cabs that are not already "radio-ready". The kit includes everything needed for easy installation including a mounting bracket and hardware for a radio, 13" rubber antenna with 60" cable, two 30W surface mounted speakers, and a 15' wiring harness to connect speakers and power to the radio.

ITEM	PART NUMBER	CASSETTE PLAYER WITH AUTO-REVERSE	ELECTRONIC TUNING	18 STATION PRESET	AUTO-PRESET MEMORY	SEEK TUNING	STONE CONTROL	BALANCE AND FADER CONTROL	CLOCK	FIXED MOUNT	U.S. FREQUENCY	WEATHER BAND	POWER OUTPUT
Radio (12V DC)	173-6530		●	●	●	●	●	●	●	●	●	●	2 X 15W
Radio (12V DC)	173-6532	●	●	●	●	●	●	●	●	●	●	●	2 X 15W
Radio (12V DC)	146-3090	●	●	●	●	●	●	●	●	●		●	2 X 15W
Radio Installation Kit	136-3643												
12V Converter (5 amp)	119-1733												

Operator Conveniences



Orange Hand Cleaner

- Contains Aloe, Lanolin, and Jojoba to help prevent dermatitis.
- Contains no petroleum solvents and is biodegradable.
- Formulated with a mild citrus smell.
- Available with pumice for extra cleaning power.
- For use in cleaning dirty, oily, or greasy hands.

ITEM	SIZE		SIZE		PACKAGE QUANTITY	PART NUMBER
	(fl oz.)	(ml)	(gal)	(L)		
Orange Hand Cleaner (smooth)	7.5	225			12	9U-5026
Orange Hand Cleaner (smooth)			1.0	3.8	4	9U-5027
Orange Hand Cleaner (with pumice)	7.5	225			12	9U-5028
Orange Hand Cleaner (with pumice)			1.0	3.8	4	9U-5029
Wall Mount Bracket for 1 gallon container					1	9U-5030

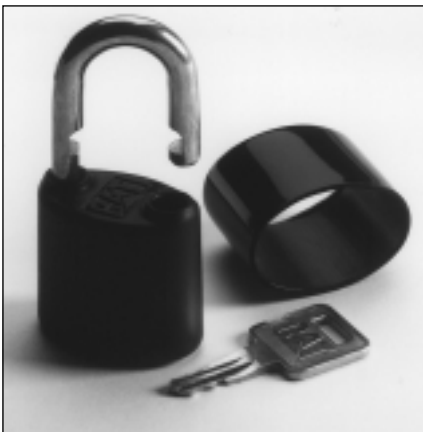

Master Padlocks

ITEM	BODY WIDTH (in)	SHACKLE HEIGHT (in)	PACKAGE QUANTITY	PART NUMBER
Steel Body Locks	1.12	0.56	12	1U-9776
Steel Body Locks	1.50	0.75	12	1U-9772
Steel Body Locks	1.50	0.75	4	1U-9774
Steel Body Locks	1.50	2.00 max	6	1U-9773
Steel Body Locks	1.75	0.94	6	1U-9770
Steel Body Locks	1.75	2.50 max	6	1U-9771
Steel Body Locks	1.88	1.19	10	5P-8502
Steel Body Locks	2.00	1.00	6	1U-9775
Brass Body Locks	1.50	0.75	6	1U-9779
Brass Body Locks	1.56	0.44	6	1U-9781
Brass Body Locks	1.75	1.31	6	1U-9777
Brass Body Locks	2.00	1.00	6	1U-9782
Combination Locks	1.88	0.75	12	1U-9783
Combination Locks	2.00	1.00	6	1U-9784



REMANUFACTURED PRODUCTS

Reman for Earthmoving Equipment 438

Reman for Paving Products 444

Reman for Engines 445

Remanufactured Products



Caterpillar remanufactured products are backed by Caterpillar's commitment to quality and performance. Our comprehensive coverage gets you back to work quickly. Plus, Cat Reman products are value priced at a fraction of new while backed by a same-as-new warranty. Products are ready to install right now, so you can minimize downtime and maintain the productivity of your Cat machine or engine.

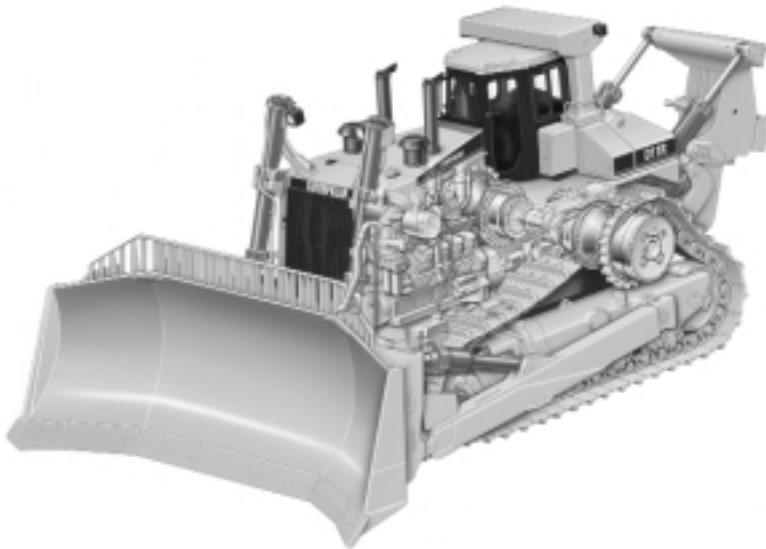

Cat Reman

As Good As New As Strong As Ever!

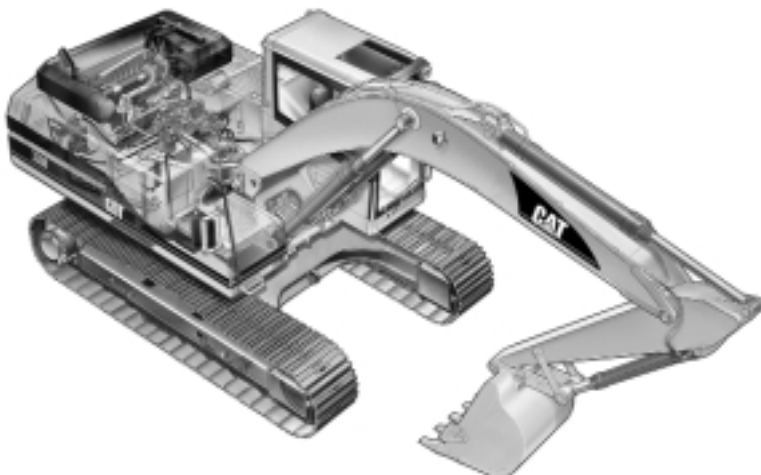

Earthmoving



Agricultural Tractors

- Brake shoes
- Clutch Plate
- Engine Components
- Final Drives and Components
- Hydraulic Pumps, Motors and Parts
- Hydraulic Cylinders and Rods
- Torque Converters
- Transmissions
- CCM (Chassis Control Modules)



Backhoe Loaders

- Hydraulic Pumps, Motors and Parts
- Hydraulic Cylinders and Rods
- Engine Components



Excavator

- Hydraulic Pumps, Motors and Parts
- Hydraulic Cylinders and Rods
- Engine Components



Forestry Machines

- Clutch Plates
- Hydraulic Pumps, Motors and Parts
- Final Drive Groups
- Hydraulic Cylinder and Rods
- Torque Converters
- Transmissions
- Final Drive Spindlers
- Engine Components

Coverages shown are typical. Please see your dealer for specific applications.

Remanufactured Products

Earthmoving



Front Shovel Excavators

- Engines and Components
- Final Drive Spindles
- Hydraulic Pumps, Motors and Parts
- Hydraulic Cylinders and Rods



Integrated Toolcarriers

- Hydraulic Pumps, Motors and Parts
- Hydraulic Cylinders and Rods
- Engine Components



Landfill Compactors

- Brake Shoes
- Clutch Plate
- Final Drives and Components
- Hydraulic Pumps, Motors and Parts
- Hydraulic Cylinders and Rods
- Transmissions
- Torque Converters
- Wheel Assemblies
- Engine Components



Motor Graders

- Brake Shoes
- Hydraulic Pumps, Motors and Parts
- Hydraulic Cylinders and Rods
- Transmissions
- Engine Components

Coverages shown are typical. Please see your dealer for specific applications.

Earthmoving



Off Highway Trucks

- Brake Shoes
- Clutch Plates
- Final Drive and Components
- Axle Housings
- Reaction Hubs
- Hydraulic Pumps, Motors and Parts
- Hydraulic Cylinders and Rods
- Torque Converters
- Transmissions
- Engine and Engine Components
- Wheel Assemblies
- Steering Clutch and Brake Groups



Pipelayers

- Brake Bands
- Clutch Plates
- Final Drives and Components
- Hydraulic Pumps, Motors and Parts
- Steering Clutch and Brake Groups
- Torque Converters
- Transmissions
- Engine Components



Scrapers

- Brake Shoes
- Clutch Plates
- Final Drives and Components
- Hydraulic Pumps, Motors and Parts
- Hydraulic Cylinders and Rods
- Torque Converters
- Transmissions
- Engine Components

Coverages shown are typical. Please see your dealer for specific applications.

Remanufactured Products

Earthmoving



Soil Compactors

- Brake Shoes
- Clutch Plates
- Final Drives and Components
- Hydraulic Pumps, Motors and Parts
- Hydraulic Cylinders and Rods
- Transmissions
- Engine Components



Telehandlers

- Hydraulic Cylinders and Rods
- Engine Components



Track Loaders

- Brake Shoes
- Brake Bands
- Clutch Plates
- Final Drives and Components
- Hydraulic Pumps, Motors and Parts
- Hydraulic Cylinders and Rods
- Transmissions
- Engine Components



Track-Type Tractors

- Brake Bands
- Clutch Plates
- Final Drives and Components
- Hydraulic Pumps, Motors and Parts
- Hydraulic Cylinders and Rods
- Steering Clutch and Brake Groups
- Torque Converters
- Transmissions
- Engines and Engine Components

Coverages shown are typical. Please see your dealer for specific applications.

Earthmoving



Tractors

- Brake Shoes
- Clutch Plates
- Final Drives and Components
- Hydraulic Pumps, Motors and Parts
- Hydraulic Cylinders and Rods
- Torque Converters
- Axle Housings
- Engines and Engine Components
- Reaction Hubs
- Wheel Assemblies



Wheel Loaders

- Brake Shoes
- Clutch Plates
- Final Drives and Components
- Hydraulic Pumps, Motors and Parts
- Torque Converters
- Transmissions
- Engines and Engine Components
- Brake Bands
- Hydraulic Cylinder and Rods



Wheel Tractors

- Brake Shoes
- Clutch Plates
- Final Drive Housings
- Hydraulic Pumps, Motors and Parts
- Hydraulic Cylinders and Rods
- Transmissions
- Engine Components

Coverages shown are typical. Please see your dealer for specific applications.

Remanufactured Products

Paving Products



Paving Products

- Auxiliary Pumps
- Conveyor Motors
- Cutter Pumps
- Hydraulic Motors and Pumps
- Propel Motors and Pumps
- Vibe Motors and Pumps
- Hydraulic Cylinders and Rods
- Eccentric Weight Housing Groups

Coverages shown are typical. Please see your dealer for specific applications.

Remanufactured Products

Remanufactured Products for Engines

ENGINE FAMILY	ENGINE MODEL	AC COMPRESSORS	AIR COMPRESSORS	ALTERNATORS	CAMSHAFTS & CAMSHAFT KITS	CONNECTING RODS	CRANKSHAFT	CYLINDER HEAD GROUPS	CYLINDER PACKS	ENGINES	ENGINE DAMPERS/BALANCERS	ENGINE OVERHAUL KITS	FLYWHEELS	FUEL / AIR RATIO CONTROLS	FUEL NOZZLES / UNIT INJECTORS	FUEL PUMPS & GOVERNORS	FUEL TRANSFER PUMPS	LONG BLOCKS	OIL COOLERS	OIL PUMPS	PRE-LUBE STARTERS ^④	ROCKER ARM ASSEMBLIES	SHORT BLOCKS	STARTERS	TURBOCHARGERS	UPRATE KITS	WATER PUMPS
1.1 liter	3114	●	●		●	●	●	●	●				●		●		●	●	●			●	●	●			●
	3116	●	●	●	●	●	●	●	●		●		●		●		●	●	●	●		●	●	●	●		●
1.7 liter	3176	●	●	●	●	●	●	●	●	●	●	●	●		●				●	●	●			●	●		●
1100	1100			●		●				⑤					●								●	●			●
1600	1600	●	●			①	●	①																●	●		
3000	3054						●	●								●								●	●		●
	3056						●	●								●								●	●		●
3100	3126	●	●	●	●	●	●	●	●		●		●		●	●	●	●	●	●		●	●	●	●		●
	3160		●	●	●	●	●	●	●	●					●			●	●	●			●	●	●		●
3200	3204		●	●	●	●	●	●			●				●				●	●			●	●	●		●
	3208	●	●	●	●	●	●	●	●	●	●		●		●	●		●	●	●			●	●	③		●
3300	3304	●	●	●	●	●	●	●	●				●	●	●	●	●	●	●	●			●	●	●		●
	3306	●	●	●	●	●	●	●	●		●		●	●	②	⑤	●	●	●	●			●	●	●		●
3400	3406	●	●	●	●	●	●	●	●	●	●	●	●	●	●	●	●	●	●	●	●	●	●	●	●	●	●
	3408	●	●	●	●	●	●	●	●	●	●	●	●	●	●	●	●	●	●	●	●	●	●	●	●	●	●
	3412	●	●	●	●	●	●	●	●	●	●	●	●	●	●	●	●	●	●	●	●	●	●	●	●	●	●
3500*	3508	●	●	●	●	●	●	●	●	●	●	●	●		●		●	●	●	●	●	●	●	●	●	●	●
	3512	●	●	●	●	●	●	●	●	●	●	●	●		●	●	●	●	●	●	●	●	●	●	●	●	●
	3516	●	●	●	●	●	●	●	●	●	●	●	●		●		●	●	●	●	●	●	●	●	●	●	●
	G350		●	●	●	●	●	●	●	●	●	●	●		●	●		●	●	●	●	●	●	●	●	●	●
	G351		●	●	●	●	●	●	●	●	●	●	●		●		●	●	●	●	●	●	●	●	●	●	●
	G351		●	●	●	●	●	●	●	●	●	●	●		●		●	●	●	●	●	●	●	●	●	●	●
3600	3606		●	●	●	●	●	●	●	●	●	●	●			●	●	●	●	●			●	●	●	●	●
	3608		●	●	●	●	●	●	●	●	●	●	●		●	●	●	●	●	●			●	●	●	●	●
	3612		●	●	●	●	●	●	●	●	●	●	●		●	●	●	●	●	●		●	●	●	●	●	●
	3616		●	●	●	●	●	●	●	●	●	●	●		●	●	●	●	●	●		●	●	●	●	●	●
C10	C10	●	●	●	●	●	●	●	●	●	●	●	●	●				●	●			●	●	●		●	
C12	C12	●	●	●	●	●	●	●	●	●	●	●	●	●				●	●			●	●	●		●	

① - 1673C/1693.

② - B Series only.

⑤ - Sleeve metering fuel system.

* Reman lifters available for some applications. Contact your dealer for details.

③ - T Model only.

④ - See Reman Products Guide for specific applications.

Remanufactured Products

Remanufactured Products for Engines

ENGINE FAMILY	ENGINE MODEL	AC COMPRESSORS	AIR COMPRESSORS	ALTERNATORS	CAMSHAFTS & CAMSHAFT KITS	CONNECTING RODS	CRANKSHAFT	CYLINDER HEAD GROUPS	CYLINDER PACKS	ENGINES	ENGINE DAMPERS/BALANCERS	ENGINE OVERHAUL KITS	FLYWHEELS	FUEL / AIR RATIO CONTROLS	FUEL NOZZLES / UNIT INJECTORS	FUEL PUMPS & GOVERNORS	FUEL TRANSFER PUMPS	LONG BLOCKS	OIL COOLERS	OIL PUMPS	PRE-LUBE STARTERS ^④	ROCKER ARM ASSEMBLIES	SHORT BLOCKS	STARTERS	TURBOCHARGERS	UPRATE KITS	WATER PUMPS
D300	D342			●	●	●	●	●	●										●					●	●		●
	D343			●		●	●	●			●								●					●	●		●
	D346		●	●		●	●	●	●					●					●		●			●	●		●
	D348		●	●		●	●	●	●					●					●		●			●	●		●
	D349		●	●		●	●	●	●					●					●		●			●	●		●
	D353			●	●		●	●	●		●			●				●		●		●		●	●		●
	D379			●	●	●	●	●	●		●								●		●			●	●		●
	D398			●	●	●	●	●	●										●		●			●	●		●
	D399			●	●	●	●	●	●										●		●			●	●		●

① - 1673C/1693.

② - B Series only.

⑤ - Sleeve metering fuel system.

* Reman lifters available for some applications. Contact your dealer for details.

③ - T Model only.

④ - See Reman Products Guide for specific applications.

SEALS

O-Rings	448
O-Ring Measuring Cone	479
O-Ring Seal Kits	479
O-Ring Materials and Applications	480
Backup Rings	483



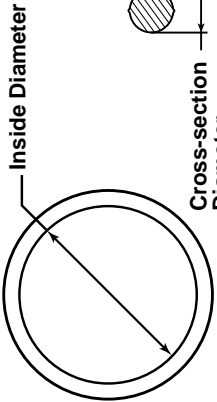

O-Ring

- Meet or exceed industry standards.
- Available in SAE A5568 (Dash) sizes as well as custom sizes used on Cat equipment.
- Available for different fluids, temperatures and pressures.
- Consistently meet stringent dimensional tolerances.
- Offer superior resistance to seal compression set for leak free performance.

CROSS SECTION DIA. (MM)	SEAL INSIDE DIA. (MM)	DASH SIZE	EPDM (70)	FLUORO-CARBON (75)	FLUORO-CARBON (90)	HNBR (72)	NBR NITRILE (60)	NBR NITRILE (70)	NBR NITRILE (75)	NBR NITRILE (90)	POLY-ACRYLIC (75)	SILICONE (70)	URETHANE (90)
1.000	6.000			107-7642									
1.020	10.030									6V-3693			
1.090	45.000				6V-1556								
1.090	64.060				6V-1555								
1.170	10.410			189-3769									
1.350	11.630								1P-8116				
1.400	6.700								085-8219				
1.400	25.630				9X-7430								
1.420	3.990			5P-9262									
1.420	4.470					9X-7379			5P-6458				
1.420	4.700	901							7M-0105			3S-2912	
1.500	4.500									3E-4288			
1.500	5.000			8C-3131									
1.500	6.500								8U-1766	3E-4289			
1.500	7.500								177-2645				
1.500	8.000									3E-4296			
1.500	8.200				8C-3076					8T-7876			
1.500	8.500			192-7111									
1.500	9.000								123-2341				
1.500	9.500								147-4214				
1.500	10.000			8U-5942						3E-4297			
1.500	11.500								7I-2750				
1.500	12.000			9X-7377									
1.500	13.500								4I-0754				
1.500	17.000				8C-3106								
1.500	17.500								112-0034				

CROSS SECTION DIA. (MM)	SEAL INSIDE DIA. (MM)	DASH SIZE	EPDM (70)	FLUORO-CARBON (75)	FLUORO-CARBON (90)	HNBR (72)	NBR NITRILE (60)	NBR NITRILE (70)	NBR NITRILE (75)	NBR NITRILE (90)	POLY-ACRYLIC (75)	SILICONE (70)	URETHANE (90)
1.500	19.500								122-7776				
1.500	52.000		175-0054										
1.570	12.700								5D-0834				
1.570	15.880								4M-6582				
1.570	31.040						2M-8663						
1.590	10.720								8M-8544				
1.590	12.700		2T-2893										
1.600	3.200		192-7110						146-6730				
1.600	9.500						2T-2677						
1.600	12.100			107-7640									
1.600	12.500			8C-3133									
1.600	13.100								8C-3097				
1.600	14.000		8C-3132										
1.600	25.100								8C-3102				
1.600	27.100								8C-3101				
1.600	29.100									186-0128			
1.630	6.070	902	8T-9587	5P-7812	109-9685	109-0093				4J-7533			
1.630	6.070	902		163-4565									
1.630	7.650	903	8K-0001	5P-7813	108-5803					7J-0204	1N-6001		
1.650	14.500				8C-3082								
1.780	1.780	004								085-7537			
1.780	2.570	005		8C-3095									
1.780	2.900	006							6H-9691				
1.780	3.650	007		6V-3685		150-4651			3H-0442				
1.780	4.470	008							8F-7219	2Y-2271		8M-8468	8T-2360
1.780	4.470	008								6V-5722			
1.780	5.280	009			107-3116				8F-9538	3G-1209		8M-5250	8T-2361
1.780	6.070	010		9N-1756					2D-6392	6V-5586		3L-6768	1P-7363
1.780	6.400									147-6603			
1.780	7.650	011		061-7538	9X-7680	9X-7380			5F-9144	3E-6760			
1.780	7.650	011								8C-3085			
1.780	7.650	011								4J-5477			
1.780	9.250	012	6D-7128	5P-8942	153-4907				1H-1023	161-6154		5H-8853	
1.780	9.250	012		8L-2779	033-6039					6V-8397			

Seals / O-Rings

CROSS SECTION DIA. (MM)	SEAL INSIDE DIA. (MM)	DASH SIZE	EPDM (70)	FLUORO-CARBON (75)	FLUORO-CARBON (90)	HNBR (72)	NBR NITRILE (60)	NBR NITRILE (70)	NBR NITRILE (75)	NBR NITRILE (90)	POLY-ACRYLIC (75)	SILICONE (70)	URETHANE (90)
1.780	10.820	013		033-5879	9X-7409	9X-7381			6M-5062	095-1750		7X-4800	126-6514
1.780	10.820	013			3E-6780								
1.780	12.420	014	180-8424	033-6033	6V-5758	9X-7408			4K-2039	161-6149			126-6515
1.780	12.420	014								6V-8398			
1.780	13.340					117-2983			008-5593				
1.780	14.000	015			033-6043	9X-7382			5L-4758	095-1751		5P-6620	126-6516
1.780	15.600	016	6V-5138	8L-2746	6V-5142				4D-2297	8C-3086			
1.780	15.720			136-7226	152-2938					7J-9108			
1.780	17.170	017		2P-2975	135-2652	9X-7383			8T-6447	6V-8399			
1.780	17.170	017							1S-8947				
1.780	18.770	018		5P-9757	9X-7681				8M-8997	9X-7454			
1.780	18.770	018								8C-3087			
1.780	18.940									6V-9746			
1.780	20.340	019							2Y-2272				
1.780	20.350	019		033-6044	5E-9816					6V-6580			
1.780	21.950	020		5P-5599					030-4605	8J-2413			061-8341
1.780	23.520	021		106-9586	8C-3093								
1.780	23.520	021							8C-3098	8C-3088			
1.780	23.660									5K-9090			
1.780	25.120	022		175-3135	8T-9529				5L-4759				
1.780	25.120	022		6V-9178									
1.780	26.700	023		033-6032	136-3377	9X-7384			077-3241	005-8592			
1.780	28.300	024		5P-5600					003-8137	4K-4986			
1.780	29.870	025		9X-7734					6V-0894	2Y-2347		5P-6436	
1.780	30.010									6V-8400			
1.780	31.470	026			8C-0563				8F-0212	085-7538			
1.780	33.050	027		5P-5601					5D-6539	8T-4827			
1.780	34.650	028		5P-9658	9X-7431				5D-6543	5K-5221		5P-4932	
1.780	37.820	029		7X-4782									
1.780	37.980												
1.780	41.000	030								8T-0315			
1.780	44.170	031		5E-8767					3J-9015	5K-6526			
1.780	47.350	032		5E-8768					3P-1979	5K-0227		5P-7914	
1.780	50.520	033							6V-0895	5K-0216		5P-8907	

CROSS SECTION DIA. (MM)	SEAL INSIDE DIA. (MM)	DASH SIZE	EPDM (70)	FLUORO-CARBON (75)	FLUORO-CARBON (90)	HNBR (72)	NBR NITRILE (60)	NBR NITRILE (70)	NBR NITRILE (75)	NBR NITRILE (90)	POLY-ACRYLIC (75)	SILICONE (70)	URETHANE (90)
1.780	53.700	034							5P-9939			3P-5859	
1.780	60.050	036							077-5843	095-1753			
1.780	63.220	037		7X-4745								3P-0815	
1.780	69.570	039								113-7820		2P-5820	
1.780	72.750	040								9J-5686			
1.780	75.920	041		6V-3865				032-9714					
1.780	78.560											5P-3114	
1.780	79.000							142-6218					
1.780	82.270	042		6V-5778				5P-2931					
1.780	88.620	043	8T-2944	8T-6717				5P-3881					
1.780	94.970	044		5E-8769				7X-9372					
1.780	101.320	045		6V-1320				7X-5494				8T-2572	
1.780	107.670	046								9X-7357			
1.780	120.370	048						8C-5237					
1.780	124.400			9X-7365									
1.780	126.720	049		3E-6799									
1.780	133.070	050		6V-1934						131-3716		5P-4969	
1.780	142.340											5P-9650	
1.780	193.370											9S-6929	
1.780	228.830											1S-7390	
1.780	271.830							6V-1919					
1.800	7.000									124-0623			
1.800	14.500			128-4004									
1.830	8.920	904	6V-9027	6V-5048	033-5853	9X-7378							
1.830	10.520	905		5P-7814	137-6667						7L-3348		
1.830	10.520	905			109-3206								
1.880	7.980												
1.900	2.800								095-1508				
1.900	3.800								095-1509	7Y-5280			
1.900	4.800								095-1510	095-1572			
1.900	5.800								3T-7528	095-1573			
1.900	6.800								095-1511	095-1574			
1.900	7.800			103-8254					095-1512	095-1575			
1.900	8.800								095-1513	095-1576			

Seals / O-Rings

CROSS SECTION DIA. (MM)	SEAL INSIDE DIA. (MM)	DASH SIZE	EPDM (70)	FLUORO-CARBON (75)	FLUORO-CARBON (90)	HNBR (72)	NBR NITRILE (60)	NBR NITRILE (70)	NBR NITRILE (75)	NBR NITRILE (90)	POLY-ACRYLIC (75)	SILICONE (70)	URETHANE (90)
1.900	9.800				189-9763				095-1514	095-1578			
1.900	16.760											6V-6921	
1.980	11.890	906	6V-3250	6V-5049	033-6042					3J-1907	7L-6385		
1.980	11.890	906		109-2333	153-4906								
2.000	6.000			9X-4626						187-1979			
2.000	7.000												
2.000	7.500				8T-9528								
2.000	9.000			9X-4617									
2.000	9.500							8U-5928					
2.000	10.000			187-8567						9T-4057			
2.000	10.500				135-3437								
2.000	12.000								123-2342	3E-4298			
2.000	14.000								8T-0116				
2.000	15.000			3E-6749						122-9250			
2.000	16.000			173-8277				121-8112					
2.000	17.000				3E-6769								
2.000	20.000									3E-6761			
2.000	30.000								092-2304				
2.000	30.200			9X-4618									
2.000	32.000							8U-4125					
2.000	36.000			192-7121									
2.000	50.000							117-1495					
2.000	57.000			125-3193									
2.000	63.500								71-2749				
2.000	66.500							130-7114					
2.000	74.500								116-3682				
2.000	78.000			192-7120									
2.000	80.000			8T-9525									
2.000	84.000								107-6279				
2.000	84.500								165-9448				
2.000	103.000								191-7604				
2.000	149.500								177-2553				
2.000	160.000								196-4670				
2.100	9.400									6V-9028			

CROSS SECTION DIA. (MM)	SEAL INSIDE DIA. (MM)	DASH SIZE	EPDM (70)	FLUORO-CARBON (75)	FLUORO-CARBON (90)	HNBR (72)	NBR NITRILE (60)	NBR NITRILE (70)	NBR NITRILE (75)	NBR NITRILE (90)	POLY-ACRYLIC (75)	SILICONE (70)	URETHANE (90)
2.100	11.400									6V-6560			
2.100	13.400									8T-6850			
2.100	15.400									8T-7524			
2.100	17.400									8T-7877			
2.100	19.400									6V-7970			
2.200	9.600				9X-7317								
2.210	16.360	908	6V-6609	8L-2786	033-6028	112-5282			9X-7745	124-9346			
2.380	22.220			2T-2894									
2.390	8.970								179-0793	4P-9041			
2.390	31.420												
2.400	9.300			8T-9521									
2.400	9.800								112-0033	095-1577			
2.400	10.800								095-1515	095-1579			
2.400	11.800								095-1516	095-1580			
2.400	12.300			8T-9522						095-1581			
2.400	12.700			2T-2679					095-1517	095-1582			
2.400	13.800								095-1517				
2.400	13.800								095-1518	095-1583			
2.400	14.800			103-8255									
2.400	15.300			8U-3473									
2.400	15.800								095-1519	095-1584			
2.400	16.300				117-8766				123-2343	3E-4299			
2.400	17.800									095-1585			
2.400	18.300			8T-9523	117-8764								
2.400	19.300			9X-4619									
2.400	19.800								095-1521	095-1586			
2.400	20.300												
2.400	20.800				109-1294				095-1522	3E-6762			119-5458
2.400	21.800								095-1524	095-1590			
2.400	25.300								123-2345	3E-6763			
2.400	27.300			9X-4625									
2.400	27.700											9X-4614	
2.400	39.700											8C-0626	
2.400	52.600									189-2624			

Seals / O-Rings

CROSS SECTION DIA. (MM)	SEAL INSIDE DIA. (MM)	DASH SIZE	EPDM (70)	FLUORO-CARBON (75)	FLUORO-CARBON (90)	HNBR (72)	NBR NITRILE (60)	NBR NITRILE (70)	NBR NITRILE (75)	NBR NITRILE (90)	POLY-ACRYLIC (75)	SILICONE (70)	URETHANE (90)
2.400	67.600								8T-6716				
2.460	19.180	910	6V-3251	136-7227	152-2939	114-4427				2M-9780	7L-2224		
2.460	19.180			6V-4589	033-6027								
2.500	5.000									170-5716			
2.500	7.000				174-5057								
2.500	8.000				174-5056								
2.500	25.000									118-2725			
2.500	26.000									113-0308			
2.500	27.500									133-9279			
2.500	32.000									9X-7447			
2.500	33.000									3E-6764			
2.500	86.000				117-8765								
2.500	90.000			192-5166									
2.500	107.000				8C-3083				8C-3057				
2.500	140.000												
2.500	195.000				3E-6770								
2.620	4.420	106								8J-1699			
2.620	5.230	107								8B-7216			
2.620	6.020	108								8J-8343			
2.620	7.590	109								4J-2506			
2.620	9.190	110								6F-5559		8M-8157	
2.620	9.800				107-3118					7W-3983			
2.620	10.770	111								5H-6005		8M-5127	
2.620	12.370	112								8F-9206		8M-5251	
2.620	13.940	113								6F-4855		8M-4437	
2.620	13.940	113				132-2072							
2.620	15.540	114				117-1385							
2.620	15.540	114				118-5068				8F-3469	7L-2180	8M-5260	
2.620	17.120	115											
2.620	17.960									122-8352			
2.620	18.720	116								4J-5351		8M-4438	
2.620	20.300	117								6V-5325			
2.620	20.300	117								7F-8607		8M-5253	
2.620	20.300	117								4M-8303		8M-4389	
2.620	21.890	118										8M-4389	
2.620	21.890	118								9H-6761		8M-8283	

CROSS SECTION DIA. (MM)	SEAL INSIDE DIA. (MM)	DASH SIZE	EPDM (70)	FLUORO-CARBON (75)	FLUORO-CARBON (90)	HNBR (72)	NBR NITRILE (60)	NBR NITRILE (70)	NBR NITRILE (75)	NBR NITRILE (90)	POLY-ACRYLIC (75)	SILICONE (70)	URETHANE (90)
2.620	23.470	119		033-6034	6V-8352				4D-9986	6V-5326		9X-4609	
2.620	25.070	120		5P-3456	6V-6339				3D-4245	6V-5556		1S-7462	6V-8958
2.620	26.640	121		6V-6228					1M-1077	7E-4846		8M-4431	
2.620	26.640	121							3D-2992	085-7539			
2.620	28.240	122		5P-7530	6V-4591				2K-8199	099-8232		8M-8514	
2.620	29.820	123		7X-4744					3S-9233	6V-8978		8M-1112	
2.620	31.420	124		9X-3979	3E-6787				2S-4663				
2.620	31.420	124		8T-5452	9X-7722								
2.620	31.720									096-3044			
2.620	32.990	125		3E-6747	6V-3550				2K-8198	6V-8218		8M-8515	
2.620	32.990	125			9X-7418								
2.620	34.590	126	9X-7545	6V-4367	166-2903				5M-2057	096-6100			
2.620	34.590	126			3E-6767					096-6100			
2.620	36.170	127	5P-8065	9X-7735	107-9570				6J-2419	7E-4847			
2.620	36.170	127								6V-5393			
2.620	36.540				131-3719								
2.620	37.770	128	8C-0624	6V-7323					4D-3107	6V-5391		6F-0249	
2.620	39.340	129	6V-5143	6V-1250					5P-8215	1R-5318			
2.620	39.340	129	7X-8592										
2.620	40.940	130	3E-6788						9X-7684	6V-5597			
2.620	42.520	131	9X-7432				4J-8268		4L-7711	085-7540			
2.620	44.120	132	3E-6790						2D-0598	5P-2568	8C-4949		
2.620	45.690	133	8C-3078						7D-9749	3E-6771			
2.620	47.290	134							032-9882				
2.620	48.900	135	6V-8676						3D-2898				
2.620	50.470	136	8C-3079						8C-3080				
2.620	52.070	137			6E-5412				005-8593				
2.620	53.640	138	8C-5196	6V-5100					3D-7805				
2.620	55.240	139		6V-3832	135-2655		5J-1808		004-1963				
2.620	56.820	140		144-7338		144-7339				7Y-5269			
2.620	58.420	141		5P-5756					7J-2036	119-7843		3S-4489	
2.620	59.990	142		009-2061					8T-7000				
2.620	61.600	143		6D-7889					8S-0768				
2.620	63.170	144		009-2062					8C-3081				

Seals / O-Rings

CROSS SECTION DIA. (MM)	SEAL INSIDE DIA. (MM)	DASH SIZE	EPDM (70)	FLUORO-CARBON (75)	FLUORO-CARBON (90)	HNBR (72)	NBR NITRILE (60)	NBR NITRILE (70)	NBR NITRILE (75)	NBR NITRILE (90)	POLY-ACRYLIC (75)	SILICONE (70)	URETHANE (90)
2.620	63.200		8T-2929										
2.620	64.770	145		5P-5757	180-2391			117-7273				5S-4548	
2.620	66.340	146							5M-6509	131-3715			
2.620	67.940	147							107-4057			129-5701	
2.620	67.940	147							109-7412				
2.620	69.520	148							004-1964				
2.620	71.120	149							3K-4025				
2.620	72.690	150		8C-5197					5P-0908				
2.620	75.870	151		5E-8770					7R-8872	119-7844			
2.620	79.380					107-5769			1P-8362				
2.620	82.220	152		8C-3089	6V-3551				5P-3863	5P-2569			
2.620	88.570	153	8T-6340	6V-3834	136-3378				6V-2483				
2.620	92.410			185-3241									
2.620	93.120												
2.620	94.620	154	7X-4752		107-3119	185-3503			4F-4097	140-7969			
2.620	97.800			7X-4804									
2.620	101.270	155		6D-7146	107-3120				3K-0715				
2.620	101.270	155	9X-7549		133-6578					8T-5049			
2.620	107.620	156								1T-1068			
2.620	113.970	157		6V-7350					6S-3002				
2.620	120.320	158	117-3036	5E-8771						9X-7566			
2.620	126.670	159	9X-7697	117-8801					7J-6285				
2.620	126.670	159		9X-7422					7J-6285				
2.620	126.670	159		169-7442									
2.620	131.200									133-0128			
2.620	133.020	160							2P-1692				
2.620	139.370	161							5J-3886	117-7282			
2.620	139.370	161							5J-3886				
2.620	145.720	162		176-1378						9X-7358			
2.620	152.070	163		9X-4576					5P-3864				
2.620	158.420	164		9X-7286					8T-6404	119-7845			
2.620	164.800		4S-7762							9X-7391			
2.620	171.120	166							9D-8042				
2.620	177.470	167							5P-5397				

CROSS SECTION DIA. (MM)	SEAL INSIDE DIA. (MM)	DASH SIZE	EPDM (70)	FLUORO-CARBON (75)	FLUORO-CARBON (90)	HNBR (72)	NBR NITRILE (60)	NBR NITRILE (70)	NBR NITRILE (75)	NBR NITRILE (90)	POLY-ACRYLIC (75)	SILICONE (70)	URETHANE (90)
2.620	183.820	168							9X-7725				
2.620	190.170	169		9X-7295					9X-7683				
2.620	202.870	171			9X-7410					125-4194		7X-4799	
2.620	209.220	172							162-9997				
2.620	215.570	173							161-4102				
2.620	234.620	176		107-3114									
2.620	240.970								190-8501				
2.620	247.320	178		154-8741									
2.620	249.500								8C-5175				
2.620	260.000								8C-5177				
2.620	269.400								8C-5176				
2.620	287.910								065-2793				
2.620	330.890		194-3087										
2.650	145.720									8U-2543			
2.650	183.800									125-4189			
2.660	9.870									173-5549			
2.700	13.600								8T-0117				
2.720	19.300								006-2992				
2.800	22.700									8T-7878			
2.800	23.700									8T-7525			
2.800	29.700									8T-7526			
2.800	38.700									8C-5193			
2.950	21.920	911							9X-7692				
2.950	23.470	912	6V-5063	6V-5050	033-6036					3D-2824	7L-3385		
2.950	26.590	914		6V-1903	033-6038	119-5155				4K-1388			
2.950	29.740	916	6V-5064	5P-7701	9X-7712					7M-8485	7L-2229		
3.000	9.000			132-4240									
3.000	19.000			2T-2695									
3.000	19.500			150-7732									
3.000	23.000												
3.000	24.000									5W-9413			
3.000	26.200								133-4771				
3.000	34.000									118-3131			
3.000	36.500			9X-4621						179-9013			

Seals / O-Rings

CROSS SECTION DIA. (MM)	SEAL INSIDE DIA. (MM)	DASH SIZE	EPDM (70)	FLUORO-CARBON (75)	FLUORO-CARBON (90)	HNBR (72)	NBR NITRILE (60)	NBR NITRILE (70)	NBR NITRILE (75)	NBR NITRILE (90)	POLY-ACRYLIC (75)	SILICONE (70)	URETHANE (90)
3.000	37.460		6V-5065	5P-7815						2S-4078	7L-3386		
3.000	37.470				183-2317								
3.000	41.000							2T-2692					
3.000	43.690	924	8C-0562	5P-7816	108-5806					6K-6307	1N-6002		
3.000	49.000								121-8117				
3.000	50.000			9X-4616									
3.000	51.000							2T-2691					
3.000	53.100	928	8T-2928	9X-3978									
3.000	54.000				174-5055								
3.000	54.500				175-6715								
3.000	56.000									122-9251			
3.000	59.360	932		5P-7817						030-4606			
3.000	60.000									118-3128			
3.000	64.000									122-9252			
3.000	70.000			128-4005									
3.000	79.500								3C-5546				
3.000	84.000							125-7005					
3.000	84.500			9X-4622									
3.000	85.000				177-0344								
3.000	92.000												
3.000	96.000								109-5698				
3.000	97.000			121-9907				113-7822					
3.000	98.000									121-8094			
3.000	102.000									179-3560			
3.000	104.000												
3.000	105.000			8T-9526									
3.000	108.860												
3.000	115.000												
3.000	120.000									125-9701			
3.000	128.000												
3.000	130.000												
3.000	144.500			192-5167									
3.000	150.000												
3.000	179.000			192-5168					109-5700				

CROSS SECTION DIA. (MM)	SEAL INSIDE DIA. (MM)	DASH SIZE	EPDM (70)	FLUORO-CARBON (75)	FLUORO-CARBON (90)	HNBR (72)	NBR NITRILE (60)	NBR NITRILE (70)	NBR NITRILE (75)	NBR NITRILE (90)	POLY-ACRYLIC (75)	SILICONE (70)	URETHANE (90)
3.000	179.500								107-5665				
3.000	190.000			132-4423									
3.000	192.000			167-1829									
3.000	200.000								109-5693				
3.000	205.000						8U-5927						
3.000	210.000								109-5694				
3.000	220.000								109-5701				
3.000	224.000								121-8132				
3.000	280.000								109-5706				
3.000	315.000								109-5705				
3.000	335.000								133-4769				
3.000	360.000								109-5695				
3.000	420.000								145-6735				
3.000	420.000								145-5935				
3.100	24.400								095-1657	095-1696			
3.100	29.400								095-1658	095-1698			
3.100	34.400								095-1659	095-1700			
3.100	39.400				109-1296					095-1701			
3.100	44.400									095-1703			
3.100	49.400								095-1662	095-1704			
3.100	49.400								3A-9280				
3.100	54.400								095-1663	095-1705			
3.100	59.400									095-1706			
3.100	64.400									095-1707			
3.100	69.400									095-1708			
3.100	74.400									095-1709			
3.100	79.400			193-1736						095-1710			
3.100	84.400								8T-3338	095-1711			
3.100	89.400									095-1712			
3.100	94.400			096-3944					095-1671	095-1713			
3.100	99.400									095-1714			
3.100	104.400								095-1673	095-1715			
3.100	109.400								095-1674	095-1716			
3.100	114.400								095-1675	095-1717			

Seals / O-Rings

CROSS SECTION DIA. (MM)	SEAL INSIDE DIA. (MM)	DASH SIZE	EPDM (70)	FLUORO-CARBON (75)	FLUORO-CARBON (90)	HNBR (72)	NBR NITRILE (60)	NBR NITRILE (70)	NBR NITRILE (75)	NBR NITRILE (90)	POLY-ACRYLIC (75)	SILICONE (70)	URETHANE (90)
3.100	119.400								095-1676	095-1718			
3.100	124.400								095-1678	095-1719			
3.100	129.400									095-1720			
3.100	134.400								095-1679	095-1721			
3.100	139.400								095-1680	095-1722			
3.100	144.400								095-1681	095-1723			
3.100	152.500									107-6986			
3.100	160.000									095-7384			
3.100	174.000									095-7383			
3.100	190.000									096-4377			
3.100	259.300								6V-8101				
3.100	363.680								3F-8948				
3.150	30.000			8T-9524									
3.180	21.820								179-0794				
3.180	34.110								4D-5256				
3.180	49.230								4F-2709				
3.180	200.020								3F-8333				
3.180	323.850									4S-5805			
3.180	377.820									002-6962			
3.180	419.100										4S-5804		
3.250	114.000									140-0180			
3.250	168.740									140-0236			
3.300	31.750								4F-2928				
3.300	66.680								3F-3759				
3.300	74.630								4F-3408				
3.300	106.380								4F-9174				
3.300	195.280								4F-2410				
3.400	285.600								177-8740				
3.500	21.700								096-0034	095-1589			5I-4115
3.500	22.100								095-1525	095-1591			
3.500	23.700				190-7674				095-1526	095-1592			
3.500	24.700								095-1527	095-1593			
3.500	25.700								095-1528	095-1594			
3.500	25.700									095-1595			

CROSS SECTION DIA. (MM)	SEAL INSIDE DIA. (MM)	DASH SIZE	EPDM (70)	FLUORO-CARBON (75)	FLUORO-CARBON (90)	HNBR (72)	NBR NITRILE (60)	NBR NITRILE (70)	NBR NITRILE (75)	NBR NITRILE (90)	POLY-ACRYLIC (75)	SILICONE (70)	URETHANE (90)
3.500	28.700								095-1530	095-1596			
3.500	29.700								095-1531	095-1597			
3.500	30.700								095-1532	095-1598			
3.500	31.700								095-1533	095-1599			103-8173
3.500	33.700								095-1534	095-1600			
3.500	34.700								8T-2148	095-1601			
3.500	35.700								095-1536	095-1602			
3.500	37.700			190-7673					095-1537	095-1603			
3.500	38.700								095-1538	096-5572			
3.500	39.700								095-1539	095-1604			
3.500	40.700								095-1540	095-1605			
3.500	41.700								095-1541	095-1606			
3.500	43.700									095-1607			
3.500	44.700								095-1543	095-1608			
3.500	45.700								095-1544	095-1609			
3.500	47.700									095-1610			
3.500	48.000			177-0343								8C-5212	
3.500	48.700								095-1545	095-1611		8C-5213	
3.500	49.700								095-1547	095-1613		8C-5214	
3.500	84.600											8M-8281	
3.500	89.600								2H-5001	9J-6491			
3.500	94.600									6V-5555			
3.530	5.940	202	6V-4366										
3.530	7.520	203	137-8101										
3.530	9.120	204	7X-4805	6V-3548					2J-6274	6V-0913			
3.530	10.690	205	119-9443										
3.530	10.690	205	6V-5759										
3.530	12.290	206	5P-0840						2M-4453	5P-6300		8M-4447	
3.530	13.210											5M-1868	
3.530	13.870	207	125-1372						3H-3385			8M-8282	
3.530	13.870	207										5P-9557	
3.530	15.470	208	8C-0504	5P-5598					2J-0157	6J-1038		8M-4448	
3.530	17.040	209		5P-8119									
3.530	18.640	210	5P-3148	5P-6718		169-7487			5F-7054	4J-5140		8M-4435	

Seals / O-Rings

CROSS SECTION DIA. (MM)	SEAL INSIDE DIA. (MM)	DASH SIZE	EPDM (70)	FLUORO-CARBON (75)	FLUORO-CARBON (90)	HNBR (72)	NBR NITRILE (60)	NBR NITRILE (70)	NBR NITRILE (75)	NBR NITRILE (90)	POLY-ACRYLIC (75)	SILICONE (70)	URETHANE (90)
3.530	18.660								8U-6426				
3.530	20.220	211		061-7539		9X-7385			1H-8171	008-2103			
3.530	21.820	212		3P-1156		112-3132			3H-0107	4J-8996		8M-4445	
3.530	23.390	213		6V-3683	109-3207				5H-2767			8M-4446	035-0273
3.530	24.990	214		117-8803	109-3205				5F-1678	4J-5267		8M-4988	
3.530	24.990	214		3P-1155									
3.530	25.400									141-7454			
3.530	26.570	215		5P-8118					4F-8946	180-8722		8M-4432	
3.530	26.570	215								7X-1550			
3.530	28.170	216		061-9458		121-0145			2H-3932	4J-8997		8M-5248	
3.530	29.740	217		165-4854					4F-9029	6V-0357		8M-4433	
3.530	29.740	217		5P-8883						6V-0357			
3.530	31.340	218		5P-8210	134-5691				6F-6673	4J-0519		8M-5254	
3.530	32.920	219		5P-8066	170-5715				4F-7391	4J-0520		8M-4987	
3.530	32.920	219			9X-7557								
3.530	34.520	220	7L-4774	5P-4268	3E-6766				3H-1461	4J-0521		8M-5249	
3.530	36.090	221		6V-5266	9X-7419				5F-9657	4J-8998		1S-9799	
3.530	37.690	222		061-7540	191-2962	118-7214			4F-7952	4J-0522	7L-2175	8M-4986	
3.530	39.270								2J-1826				
3.530	40.870	223		061-8561	061-8561	118-8586			6F-0711	4J-5573		8M-4992	
3.530	40.870	223			194-9584				099-0187				
3.530	40.870	223			8J-8725								
3.530	44.040	224	8T-9588	8J-4351	5P-1480	129-1653			1H-9696	4J-0523		8M-4443	
3.530	47.220	225	8T-1702	061-9455					7F-8267	4J-0524		8M-5661	
3.530	50.390	226		5P-8211					5F-8000	4J-0525		8M-4436	
3.530	50.390	226		6V-6756									
3.530	53.570	227		061-9456	8C-3077				7F-8268	4J-0526		8M-5010	
3.530	53.570	227		124-1858									
3.530	53.970									141-7452			
3.530	55.600								137-3623				
3.530	56.740	228	8T-1703	6V-4368		112-1577			8F-6711	4J-0527		8M-4390	
3.530	59.920	229		5P-4892					1H-8720	4J-0528		1S-2174	
3.530	59.920	229							175-7894				
3.530	63.090	230		061-9457					1H-5728	3P-0439		8M-4395	

CROSS SECTION DIA. (MM)	SEAL INSIDE DIA. (MM)	DASH SIZE	EPDM (70)	FLUORO-CARBON (75)	FLUORO-CARBON (90)	HNBR (72)	NBR NITRILE (60)	NBR NITRILE (70)	NBR NITRILE (75)	NBR NITRILE (90)	POLY-ACRYLIC (75)	SILICONE (70)	URETHANE (90)
3.530	65.070								5B-4399				
3.530	66.270	231		6J-2244		118-8708			8F-8882	3E-6730		8M-5252	
3.530	66.270	231				118-8706							
3.530	69.440	232	167-4407	033-6031	8T-0568	112-1574			175-7895	6J-2680		9M-7539	
3.530	69.440	232							5H-8848				
3.530	72.620	233		6V-1179					6H-3977	149-0231			
3.530	75.790	234		5P-4889					175-7896			5M-3038	
3.530	75.790	234							1H-7339				
3.530	78.970	235		153-1157	170-7098				2H-6184	3E-6732			
3.530	78.970	235							175-7897				
3.530	82.140	236	8C-3073	6V-1196	170-4821				2H-3931	6V-6707		6L-9965	
3.530	85.320	237	8C-3072	124-1859					2H-6338	117-1266		2P-3538	
3.530	85.320	237		6V-8001						2H-6338			
3.530	88.490	238		6V-8002					2H-4145	6R-0365		3S-1427	
3.530	88.490	238							175-7898				
3.530	91.670	239		131-3718					8H-7521	3E-6735		2M-2561	
3.530	92.080									5D-6618			
3.530	94.840	240		3E-6773					1H-8128	5P-6302		5K-1770	
3.530	98.020	241		6V-1197					175-7900	9X-4611		9M-9936	
3.530	98.020	241							2H-3934				
3.530	101.190	242		6V-6353					1H-6227			2S-2182	
3.530	104.370	243		5D-5957					4M-0189			7M-9909	
3.530	107.540	244		3E-6785					2H-3928		7L-3313	8S-5654	
3.530	110.720	245		6V-5053					4H-9105	3E-6703		9M-9729	
3.530	110.720	245		8T-9527					175-7902				
3.530	113.890	246		9X-7287					5H-6734	190-3011			
3.530	117.070	247		5D-5958					2J-8163			5P-1705	
3.530	120.240	248		125-9794					5F-3144	175-7903	7L-2211	8M-5255	
3.530	123.420	249		6V-8260					5F-3999			7M-6637	
3.530	126.590	250		9X-7371					5F-3106	031-4392		4S-5898	
3.530	126.590	250							175-7904				
3.530	129.770	251		130-0229					3F-5792		7L-4090	5P-3457	
3.530	129.770	251		5P-8286									
3.530	132.940	252		6V-7351					175-7905			9N-1619	

Seals / O-Rings

CROSS SECTION DIA. (MM)	SEAL INSIDE DIA. (MM)	DASH SIZE	EPDM (70)	FLUORO-CARBON (75)	FLUORO-CARBON (90)	HNBR (72)	NBR NITRILE (60)	NBR NITRILE (70)	NBR NITRILE (75)	NBR NITRILE (90)	POLY-ACRYLIC (75)	SILICONE (70)	URETHANE (90)
3.530	132.940	252							2H-9247				
3.530	136.120	253		6V-1195					2H-3935			9N-2693	
3.530	139.290	254							8F-9516	190-3010		8M-5007	
3.530	142.470	255		161-8068		129-1609			2D-8009			6V-1904	
3.530	145.640	256	6V-3428		6V-3549				5H-3252	6J-5541			
3.530	148.820	257		161-8069		129-1610			2K-8257			3S-5135	
3.530	151.990	258		6V-5553	170-7106				8F-8733	7D-9014	2L-1778	5D-4311	
3.530	158.340	259		6V-3319					2K-4472		7L-3380	8M-4704	
3.530	158.340	259										6V-3689	
3.530	164.690	260		6V-7681	175-5077				6F-4718			1S-4974	
3.530	171.040	261		5P-8428	170-4825				9F-1399	061-9729		2S-4071	
3.530	177.390	262		6V-1902					2K-2939		7L-2181	5S-4554	
3.530	183.740	263		6V-3907	175-5088				4H-6520		7L-3314	1S-6119	
3.530	190.090	264	6V-5098			149-5461			3J-0634	5J-2383			
3.530	196.440	265	8T-2921						1H-8278	126-4003	8L-5189		
3.530	202.790	266							1J-2176	7Y-4277		9M-9545	
3.530	204.000	266								9C-3493			
3.530	209.140	267				122-3771			9M-5024	7Y-4294		9N-2694	
3.530	214.300								2M-0340				
3.530	215.490	268		156-5198		122-3772			4K-6804				
3.530	221.840	269							8F-5900				
3.530	226.000								116-7830				
3.530	228.190	270		6V-3684					8F-6230				
3.530	230.670											146-7311	
3.530	234.540	271							1T-0132			8L-3017	
3.530	238.230											146-7312	
3.530	240.890	272							2D-9572	126-4002		9N-1609	
3.530	247.240	273							5S-3676				
3.530	253.590	274							5H-4909			7D-1979	
3.530	266.290	275							8J-8879				
3.530	269.880								9H-5548				
3.530	278.990	276							2R-0239				
3.530	281.940									5D-4187			
3.530	282.370								6V-7991				

CROSS SECTION DIA. (MM)	SEAL INSIDE DIA. (MM)	DASH SIZE	EPDM (70)	FLUORO-CARBON (75)	FLUORO-CARBON (90)	HNBR (72)	NBR NITRILE (60)	NBR NITRILE (70)	NBR NITRILE (75)	NBR NITRILE (90)	POLY-ACRYLIC (75)	SILICONE (70)	URETHANE (90)
3.530	285.800									4D-5497			
3.530	291.690	277							5P-2545			9N-1520	
3.530	298.450								9X-7686				
3.530	304.390	278		165-4852					2D-6533				
3.530	307.570			5P-9035									
3.530	316.870								5P-2861				
3.530	317.910											6V-2406	
3.530	323.440									5J-1086			
3.530	329.790	279							4D-6695			9N-1552	
3.530	340.990								171-9375				
3.530	345.000								116-5897				
3.530	351.000								171-9298				
3.530	355.190	280		5D-5959					4S-5879			9N-1562	
3.530	367.890								6D-0692				
3.530	380.590	281							4D-1577				
3.530	385.340			6V-5058					8D-2714				
3.530	399.800								5P-9147				
3.530	405.260	282							7S-8561				
3.530	412.340								2P-3628				
3.530	413.490								7Y-1455				
3.530	430.660	283							4S-5924				
3.530	454.910								7X-1548				
3.530	470.000								8C-5240				
3.530	481.460								2D-6507				
3.530	484.860								6W-4310				
3.530	500.740								136-2967				
3.530	523.470								7D-7519				
3.530	535.500								6V-6204				
3.530	552.040								4D-0449			9X-7550	
3.530	570.000												
3.530	576.480								7Y-0640				
3.530	606.020								7D-5868				
3.530	669.000								129-9124				
3.530	698.090								6D-1355				

Seals / O-Rings

CROSS SECTION DIA. (MM)	SEAL INSIDE DIA. (MM)	DASH SIZE	EPDM (70)	FLUORO-CARBON (75)	FLUORO-CARBON (90)	HNBR (72)	NBR NITRILE (60)	NBR NITRILE (70)	NBR NITRILE (75)	NBR NITRILE (90)	POLY-ACRYLIC (75)	SILICONE (70)	URETHANE (90)
3.530	749.000								5P-4076				
3.530	1108.000											150-8791	
3.550	155.000			129-5426									
3.550	185.000							123-2003					
3.600	24.600			3E-6775					4F-5675			1H-3748	
3.960	11.130											3H-2387	
3.960	14.270												
3.960	22.220								4F-5676				
3.960	25.400							8B-6015					
3.960	38.1											3H-2389	
3.960	76.2											4D-6773	
3.960	88.04											7H-0538	
3.960	117.480								7F-6268				
4.000	38.000							121-7687					
4.000	45.000			121-8116									
4.000	65.000									114-8837			
4.000	75.000									112-6921			
4.000	76.000									125-7001			
4.000	80.000									135-7940			
4.000	95.000								165-8066			3E-6752	
4.000	102.000									112-6920			
4.000	112.000									118-2718			
4.000	140.000								9X-7440				
4.000	150.000								111-7052				
4.000	160.000								109-5704				
4.000	165.000								141-0749				
4.000	172.000								8C-3058				
4.000	330.000								109-5707				
4.000	375.000								109-5703				
4.000	530.000								133-4767				
4.000	595.000								109-5692				
4.290	9.520								7B-0305				
4.300	9.530											3S-5496	
4.300	9.530											3S-5496	

CROSS SECTION DIA. (MM)	SEAL INSIDE DIA. (MM)	DASH SIZE	EPDM (70)	FLUORO-CARBON (75)	FLUORO-CARBON (90)	HNBR (72)	NBR NITRILE (60)	NBR NITRILE (70)	NBR NITRILE (75)	NBR NITRILE (90)	POLY-ACRYLIC (75)	SILICONE (70)	URETHANE (90)
4.310	140.200		142-7072	142-6217									
4.310	140.200		6V-5121	3E-6777									
4.310	140.200			3E-6777									
4.310	141.000				110-2220								
4.390	42.880							7B-6868					
4.390	101.600							7B-2125					
4.390	113.800		3S-3977										
4.390	117.100		5S-6670										
4.700	357.380							4F-5291					
4.780	7.920							2A-3307					
4.780	25.400							2A-3854					
4.780	73.020							3F-9141					
4.780	76.200							5B-3323					
4.780	83.950										3H-2726		
4.780	93.680							5B-4484					
4.780	107.920							1Y-6637					
4.780	169.880							3F-8774					
4.780	193.680							7F-7151					
4.780	219.080							7B-5716					
4.780	249.220							9F-3384					
4.780	290.530							7F-2094					
4.780	320.680							7F-2093					
4.780	469.900							4F-2411					
4.880	84.070							6F-8509					
4.880	112.730							4F-7471					
4.880	133.800		6H-6998										
4.880	139.800		3S-3978										
4.880	152.400		6L-7812									5P-4360	
4.880	165.100		6L-7815									5P-4361	
4.880	175.000		7N-2046										
5.000	120.000									135-7933			
5.000	205.000							8C-3059					
5.000	248.000							133-4768					
5.000	780.000							109-5699					

Seals / O-Rings

CROSS SECTION DIA. (MM)	SEAL INSIDE DIA. (MM)	DASH SIZE	EPDM (70)	FLUORO-CARBON (75)	FLUORO-CARBON (90)	HNBR (72)	NBR NITRILE (60)	NBR NITRILE (70)	NBR NITRILE (75)	NBR NITRILE (90)	POLY-ACRYLIC (75)	SILICONE (70)	URETHANE (90)
5.000	820.000								109-5696				
5.000	900.000								109-5697				
5.260	445.500			8T-0115									
5.330	7.140			4G-4972								3H-2388	
5.330	12.070	310		8S-5011					3H-4970			1S-7104	
5.330	15.240	312		6V-3955					5H-8038			8M-4990	
5.330	18.420	314	6V-5061	6V-3348					3B-8453			1S-0004	
5.330	19.300											9M-4618	
5.330	19.990	315		5P-8870					9H-4557				
5.330	21.590	316	6V-5062	2N-3350					6H-5672			9H-6067	
5.330	23.160	317	7L-4773	5P-9890	032-8969	114-2687			8F-4994			9M-4849	
5.330	23.160	317		112-3540									
5.330	24.770	318	8T-0280	6V-4430					8B-4967			8M-5266	
5.330	24.770	318		6V-4480									
5.330	27.940	320		3P-0648					5H-7370			8M-4991	
5.330	31.120	322	7L-6580	6V-5134					4F-5607			5H-7153	
5.330	32.690	323							5M-7423				
5.330	34.290	324	5P-7204	6V-3830					5M-5860		5P-5316	1S-9544	
5.330	37.470	325	6V-9769	5P-8068		109-0078	3S-6538		4F-7389		5L-2727	9M-7002	
5.330	40.640	326	6L-7817	5P-5846		109-0072			2H-3927	8S-5953		9M-9647	
5.330	43.820	327	2N-5749	8C-5230		109-0073			4F-8824			2S-2251	
5.330	43.820	327										8S-4190	
5.330	46.200											9M-2610	
5.330	46.990	328	6V-1585	8C-3107		112-3258			4F-9653	9S-8307		6L-1648	
5.330	46.990	328										7S-3206	
5.330	50.160	329	5S-1105	3P-0650		109-0076	2H-3088		5K-5959			6L-1651	
5.330	50.170	329	171-4358	113-5304									
5.330	53.340	330	2N-5243	6V-3831		112-3260			4F-7390				
5.330	56.520	331	2N-0475	109-2332		110-7752			3H-2652	7S-4001		6L-1650	
5.330	56.520	331		3P-0649									
5.330	59.690	332		3P-0651		112-3259			6F-8146	099-4780		6L-9284	
5.330	62.870	333	8T-1919	3P-0657		112-1102			2H-2665	2R-0039		6L-1649	
5.330	66.040	334		3P-0656					2H-3933			8H-1607	
5.330	69.220	335		3P-0653		109-0075			7F-2122	006-8352		8M-4989	

CROSS SECTION DIA. (MM)	SEAL INSIDE DIA. (MM)	DASH SIZE	EPDM (70)	FLUORO-CARBON (75)	FLUORO-CARBON (90)	HNBR (72)	NBR NITRILE (60)	NBR NITRILE (70)	NBR NITRILE (75)	NBR NITRILE (90)	POLY-ACRYLIC (75)	SILICONE (70)	URETHANE (90)
5.330	72.390	336	6V-1454	3P-0655		110-7753			5F-3092			9M-4218	
5.330	75.570	337		6V-5051		109-0092			7H-2444				
5.330	78.740	338		6V-3833		109-0079			9F-4446		7L-2174	1M-6036	
5.330	81.920	339		6V-5656					4L-9564	5D-1597		6L-5359	
5.330	85.090	340	6V-5066	3P-0654					8H-2046			9M-4217	
5.330	88.270	341		6V-0973		112-8186			1H-0474				
5.330	91.440	342		5P-7818		109-0074			5F-0149			9X-7727	
5.330	94.620	343		6V-4315					5H-8624				
5.330	97.790	344	6V-5139	5S-9134		109-0080			9M-2092			6V-5188	
5.330	100.970	345		6V-3908		109-0077			4F-7387	9X-7458	7L-2197	4H-3243	
5.330	104.140	346		6V-5052					1J-2859				
5.330	107.320	347	6V-5504	6V-5101					9F-7283			1S-1225	
5.330	110.490	348		7D-7111					1S-7408				
5.330	113.670	349	6V-5140	5P-8872		112-1580			5H-5672			8S-5655	
5.330	116.840	350	6V-5067	8C-3103					5P-4326				
5.330	120.020	351		5P-8940					1P-9005				
5.330	123.190	352	8T-2903	7X-1547		109-0081			2S-8439				
5.330	123.900											107-3185	
5.330	126.360												
5.330	129.540	354	6V-5068	6V-4314	170-7103				068-9002				
5.330	132.720	355							8J-1688				
5.330	135.890	356		9X-7562	170-7105				5P-1979				
5.330	139.070	357	6V-6809	6V-5054					9X-7375			3S-1219	
5.330	142.240	358		6V-3835					9M-3786				
5.330	145.420	359							6D-9157				
5.330	148.590	360							3S-1223				
5.330	151.770	361		6V-5055	170-4823				6V-5657				
5.330	158.120	362		6V-4297					7J-8956				
5.330	164.470	363			170-4824				8T-6444			8C-3091	
5.330	170.820	364							8J-1665			7S-8758	
5.330	177.170	365		109-7411			107-6280			5P-7593			
5.330	183.520	366		6V-5102					8T-7568			9X-7704	
5.330	189.860	367							5K-1787				
5.330	196.220	368		6V-3349					3F-1547				
									5M-7142				

Seals / O-Rings

CROSS SECTION DIA. (MM)	SEAL INSIDE DIA. (MM)	DASH SIZE	EPDM (70)	FLUORO-CARBON (75)	FLUORO-CARBON (90)	HNBR (72)	NBR NITRILE (60)	NBR NITRILE (70)	NBR NITRILE (75)	NBR NITRILE (90)	POLY-ACRYLIC (75)	SILICONE (70)	URETHANE (90)
5.330	199.390									8J-4386			
5.330	202.570	369	6V-7703	177-6911					9M-5894				
5.330	208.920	370		5P-8429					4N-1230				
5.330	211.190					134-5958							
5.330	215.270	371							5P-3092				
5.330	221.620	372		6V-5141		134-5959			5H-4081	1U-3174			
5.330	227.970	373								5P-5374		5D-9344	
5.330	234.320	374		6V-5375									
5.330	240.670	375		6V-7701						5P-2235		5P-8105	
5.330	253.360	377							8L-9241				
5.330	266.070	378		5P-8871					3S-3074	109-5702		5P-5819	
5.330	266.070	378		174-3357								5P-5819	
5.330	270.210									5P-2236		2W-2073	
5.330	278.770	379		6V-5554									
5.330	287.000			8C-9023									
5.330	291.470	380		6V-5057					2M-1309				
5.330	300.420									130-9108			
5.330	304.170	381		159-8802		158-6563				6V-3263			
5.330	310.130								5H-4082				
5.330	317.240			6V-7702									
5.330	325.000		1W-0115										
5.330	329.570	382		9X-7688					7S-8554				
5.330	335.000			6V-3602									
5.330	342.900								2M-3818				
5.330	350.420									130-9109			
5.330	354.970	383		8C-3828					6V-1175				
5.330	355.190									4T-4128			
5.330	371.420									130-9110			
5.330	372.000			8T-0098									
5.330	380.370	384		118-7536					2M-3340				
5.330	383.600			9X-7428									
5.330	390.000			6V-4244									
5.330	399.420								7S-4571				
5.330	405.300								5M-6200				

CROSS SECTION DIA. (MM)	SEAL INSIDE DIA. (MM)	DASH SIZE	EPDM (70)	FLUORO-CARBON (75)	FLUORO-CARBON (90)	HNBR (72)	NBR NITRILE (60)	NBR NITRILE (70)	NBR NITRILE (75)	NBR NITRILE (90)	POLY-ACRYLIC (75)	SILICONE (70)	URETHANE (90)
5.330	411.480								5M-7329				
5.330	415.000			6V-9670									
5.330	421.700			8T-8883									
5.330	422.000								144-8299				
5.330	430.660	386							5P-9806			9L-5650	
5.330	440.690								6M-5218				
5.330	456.060	387		6V-5059					2R-0098				
5.330	481.410	388							8D-4771				
5.330	494.660			6V-5043					9H-0846				
5.330	514.650								9M-5892				
5.330	532.210	390							4H-6730				
5.330	548.640											8S-6251	
5.330	557.610	391							9H-3360				
5.330	558.000		156-5197										
5.330	582.680	392							3D-8422				
5.330	608.100								8T-3013				
5.330	621.000		154-9416										
5.330	633.480	394							9H-6832				
5.330	643.380								8D-5096				
5.330	684.280								5D-7523				
5.330	736.600			159-8752					2D-6506				
5.330	760.000								5P-4057				
5.330	786.760								3D-3295				
5.330	795.000											186-3712	
5.330	843.000											5P-9519	
5.330	870.000											143-8729	
5.330	920.000											111-1503	
5.330	940.000											6V-6557	
5.330	1146.000											113-1700	
5.330	1180.000											152-0985	
5.340	136.500							8U-5059					
5.340	380.000								144-0618				
5.500	32.000								121-8140				
5.600	130.000									140-7651			

Seals / O-Rings

CROSS SECTION DIA. (MM)	SEAL INSIDE DIA. (MM)	DASH SIZE	EPDM (70)	FLUORO-CARBON (75)	FLUORO-CARBON (90)	HNBR (72)	NBR NITRILE (60)	NBR NITRILE (70)	NBR NITRILE (75)	NBR NITRILE (90)	POLY-ACRYLIC (75)	SILICONE (70)	URETHANE (90)
5.700	45.600											8C-0627	
5.700	49.600								095-1546	095-1612			
5.700	51.600								096-0121	095-1614			
5.700	52.600									095-1615			
5.700	54.600								8T-6346	095-1616			
5.700	55.600									095-1617			
5.700	57.600									095-1618			
5.700	59.600								095-1549	095-1619			
5.700	61.600									095-1620			
5.700	64.600								095-1550	095-1621			
5.700	69.600								095-1551	095-1622			
5.700	74.600								095-1552				
5.700	79.600								095-1553	095-1623			
5.700	84.600								095-1554	095-1624			
5.700	89.600								095-1555	095-1625			
5.700	94.600								095-1556	095-1626			
5.700	99.600								095-1557	095-1627			
5.700	104.600								096-7041	095-8859			
5.700	109.600								095-1558	095-1628			
5.700	111.600								132-3056	095-1629			
5.700	111.600								095-1559				
5.700	114.600								095-1560	095-1630			
5.700	119.600								096-0071	095-1631			
5.700	124.600								095-1561	096-5382			
5.700	129.600								095-1562	095-1632			
5.700	139.600								095-1563	095-1633			
5.700	144.600								095-1564	095-1634			
5.700	149.300								095-1682	095-1724			
5.700	149.600									095-1635			
5.700	150.000									140-7663			
5.700	154.300								096-4921	095-1725			
5.700	159.300								095-1683	095-1726			
5.700	164.300									095-1727			
5.700	169.300								095-1684	095-1728			

Seals / O-Rings

CROSS SECTION DIA. (MM)	SEAL INSIDE DIA. (MM)	DASH SIZE	EPDM (70)	FLUORO-CARBON (75)	FLUORO-CARBON (90)	HNBR (72)	NBR NITRILE (60)	NBR NITRILE (70)	NBR NITRILE (75)	NBR NITRILE (90)	POLY-ACRYLIC (75)	SILICONE (70)	URETHANE (90)
6.350	60.960								7F-9134				
6.350	350.800								4L-3579				
6.480	139.700								7B-2123				
6.940	93.000									138-2675			
6.980	32.920										9F-0096		
6.980	116.840										9M-8788		
6.980	120.020										3H-0976		
6.980	126.360										2M-5173		
6.980	139.060										6H-1995		
6.980	148.590										5D-6642		
6.980	151.760										6L-5473		
6.980	164.460										7M-6952		
6.980	202.560										6L-5360		
6.980	227.960										2S-2966		
6.990	12.700								3B-7363				
6.990	31.120		8C-5209						4H-1860		6L-4905		
6.990	37.460								7H-9959				
6.990	42.800								8S-0530				
6.990	46.990								1M-3548				
6.990	56.520			5P-6861					7D-1195		4M-0142		
6.990	61.600								5P-8432				
6.990	64.260								1T-0136				
6.990	69.220								1M-0556		4M-0141		
6.990	75.560								5H-2824		5H-9205		
6.990	81.000					125-4641					4L-8337		
6.990	81.920		7L-7459	5P-5700									
6.990	85.090								2A-3676				
6.990	88.260			130-5694		125-4642			6K-9149		5S-1188		
6.990	91.440								5S-0982				
6.990	94.610										5H-7704		
6.990	94.620		7L-7460	6V-3917									
6.990	100.960			6V-2695							5H-1039		
6.990	104.140										8H-7469		
6.990	107.310			6V-5166							6H-1871		

CROSS SECTION DIA. (MM)	SEAL INSIDE DIA. (MM)	DASH SIZE	EPDM (70)	FLUORO-CARBON (75)	FLUORO-CARBON (90)	HNBR (72)	NBR NITRILE (60)	NBR NITRILE (70)	NBR NITRILE (75)	NBR NITRILE (90)	POLY-ACRYLIC (75)	SILICONE (70)	URETHANE (90)
6.990	113.660											7S-1156	
6.990	113.670	425							114-9275				
6.990	116.840	426		170-5941					9S-3888	107-6259			
6.990	120.020	427	7L-2031										
6.990	123.190	428		5S-6760						6F-0671			
6.990	126.370	429	6L-9405	6V-5103					8F-4469				
6.990	132.720	431							5H-9524				
6.990	135.890	432		3E-6751					4F-7507				
6.990	139.070	433	6V-5373	6V-5167					5H-6733	143-4637			
6.990	148.590	436		5P-8861					5P-3620	003-2770			
6.990	151.770	437		5P-8862					8H-0273	6H-4162			
6.990	158.120	438				112-1579			5L-5032				
6.990	164.470	439		6V-3968	170-7100				2H-6124				
6.990	164.470	439		135-6950									
6.990	170.820	440	5P-6619						2D-1692	006-8350			
6.990	177.170	441		6V-5095					4F-9652			5D-7665	
6.990	183.520	442		7X-4810					2D-1690				
6.990	189.860	443							5F-6222				
6.990	199.260								2M-0338				
6.990	202.560	445		3P-0658					2D-1691				
6.990	208.900			170-4822									
6.990	210.900												
6.990	215.260	446							161-4511				
6.990	218.500			6V-3603					4F-7388		2N-6037	6V-1905	
6.990	224.790												
6.990	227.960	447							4D-6548				
6.990	240.660								1J-2890		7L-2176		
6.990	253.370	449							1M-9015				
6.990	266.070	450			175-5086				3E-6794		1N-6000		
6.990	268.440			9X-7442					8F-8861				
6.990	278.760	451							5P-3487				
6.990	287.410								2H-6340				
6.990	291.460	452							129-3719				
6.990	304.160								8H-8257				
6.990									4M-0661				

Seals / O-Rings

CROSS SECTION DIA. (MM)	SEAL INSIDE DIA. (MM)	DASH SIZE	EPDM (70)	FLUORO-CARBON (75)	FLUORO-CARBON (90)	HNBR (72)	NBR NITRILE (60)	NBR NITRILE (70)	NBR NITRILE (75)	NBR NITRILE (90)	POLY-ACRYLIC (75)	SILICONE (70)	URETHANE (90)
6.990	304.200		1W-0118										
6.990	310.130								4M-0737				
6.990	316.860	454	8T-9047	6V-3967					4D-4508				
6.990	329.560	455							5M-4454				
6.990	342.270	456		6V-6638					5P-9217				
6.990	342.390								177-0448				
6.990	354.960	457							4J-1253				
6.990	367.670	458							6V-5862				
6.990	380.360	449							8F-9960				
6.990	386.240			137-4349									
6.990	393.070	450							5P-4342				
6.990	405.260	451							8F-6498				
6.990	417.960	452		137-4350					4D-4503				
6.990	430.660	453							3S-9896				
6.990	446.800								149-2695				
6.990	468.760	456							8T-4811				
6.990	481.460	457							5D-1071				
6.990	494.160	458		6V-5060					2D-8363				
6.990	520.070								5P-2587				
6.990	532.260	460							3D-8241			143-6387	
6.990	564.500												
6.990	582.680	462							2D-8364				
6.990	608.080	473							5D-6428				
7.000	79.000							118-3125					
7.000	89.000							125-9697					
7.000	97.500									140-0178			
7.000	99.000							118-2722					
7.000	102.250									140-0194			
7.000	106.000							135-7937					
7.000	145.400								2Y-8252				
7.000	158.120									140-0240			
7.000	234.300				175-5075								
7.160	18.470			139-6123								5P-2428	
7.980	76.960										1L-7548		

Seals / O-Rings

CROSS SECTION DIA. (MM)	SEAL INSIDE DIA. (MM)	DASH SIZE	EPDM (70)	FLUORO-CARBON (75)	FLUORO-CARBON (90)	HNBR (72)	NBR NITRILE (60)	NBR NITRILE (70)	NBR NITRILE (75)	NBR NITRILE (90)	POLY-ACRYLIC (75)	SILICONE (70)	URETHANE (90)
8.000	216.200								8T-6690				
8.400	149.500						113-2073						
8.400	154.500									095-1636			
8.400	164.500									095-1637			
8.400	176.400									095-1638			
8.400	179.500									095-1639			
8.400	184.500									095-1640			
8.400	189.500							095-1566					
8.400	194.500								095-1565				
8.400	199.500								095-1566	095-1641			
8.400	209.500									096-0035			
8.400	214.500								095-1567	099-4846			
8.400	229.500									096-0036			
8.400	234.500									095-1642			
8.400	239.500									096-2163			
8.400	249.500								095-1568	095-1643			
8.400	264.500									096-0037			
8.400	284.500									095-1644			
8.400	289.500								095-1569				
8.400	319.500												
8.400	384.500									096-2162			
8.400	384.500	473											
8.480	78.380												
8.640	100.790											8F-6149	
8.790	28.170												
8.790	37.340												
9.000	80.000							093-1341					
9.000	96.000							093-1342					
9.470	48.340						8P-7003					7T-4087	
9.470	60.340						6P-8912					7T-1094	
9.470	66.090						1M-3097					2S-2181	
9.470	70.340						8P-0021					7T-1093	
9.470	76.340						8H-2262					9M-9730	
9.470	92.280						8H-2265					8S-5653	

Seals / O-Rings

CROSS SECTION DIA. (MM)	SEAL INSIDE DIA. (MM)	DASH SIZE	EPDM (70)	FLUORO-CARBON (75)	FLUORO-CARBON (90)	HNBR (72)	NBR NITRILE (60)	NBR NITRILE (70)	NBR NITRILE (75)	NBR NITRILE (90)	POLY-ACRYLIC (75)	SILICONE (70)	URETHANE (90)
9.470	102.340						6H-1309					3P-1847	
9.470	127.740											5P-2499	
9.520	70.100								1H-7683				
9.520	196.850								3K-1516				
10.000	124.700							107-9976					
10.000	140.000							093-1344					
10.000	155.000							093-1345					
10.000	175.000							093-1349					
10.000	200.000							093-1347					
10.000	230.000							101-2154					
11.430	300.610						9M-6097						
11.430	326.000						4V-4884						
12.700	147.470											3N-0801	
12.700	147.470											5P-3401	
12.700	164.470						7M-0475						
12.700	184.950						2M-0344					3N-0759	
12.700	224.900						1M-9011					5P-1606	
12.700	232.800											9W-6612	
12.700	262.690						4K-0173						
12.700	265.000						4M-0660					5P-1608	
12.700	280.030						7T-2457						
12.700	280.030						7T-2457						
12.700	317.130						4M-0736					3P-1849	
12.700	341.750								6V-2361				
12.700	353.000								6V-2362				
12.700	364.030											9W-5976	
12.700	424.650											9W-6613	
12.700	498.630											5P-8403	
12.700	660.390											6V-2305	
12.700	820.580											6Y-8213	
14.280	650.000						9J-0818						
15.880	600.000						6A-4503						
15.880	660.400						5P-3228						
15.880	751.840						8J-3699						

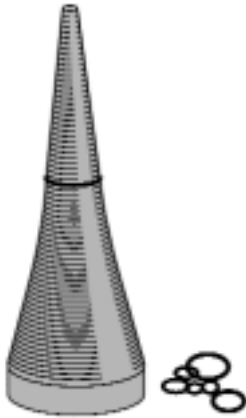

O-Ring Measuring Cone

- Designed to measure SAE industry standard O-Ring dimensions by cross section and dash size.
- Made of high impact, yellow plastic with 65 steps indicating the varying inside diameters.
- Contains a round base with five industry standard O-Ring cross section diameters cut into the edge.
- Makes finding the correct O-Ring replacement easier and faster.

ITEM	PART NUMBER
O-Ring Measuring Cone	9U-5155



O-Ring Seal Kits

- Include frequently used O-Ring sizes, reducing the need to order individual seals.
- Come in individual compartments with a rugged plastic container that latches shut for protection.
- Exceed SAE and other seal specifications, ensuring longer life and lower costs per hour.

KIT PART NUMBER	SEAL TYPE	CONSIST	APPLICATION
4C-4782	O-Ring Seal	32 Sizes, 580 Seals (Nitrile, 90 Duro)	SAE STOR and ORFS Fittings, SAE Code 61 and Code 62 Flanges
4C-5859	O-Ring Seal	8 Sizes, 120 Seals (Nitrile, 90 Duro)	SAE ORFS Fittings
9S-3135	O-Ring Seal	6 Sizes, 60 Seals (Nitrile, 90 Duro)	SAE Code 61 and Code 62 Flanges
4C-4784	Rectangular Seal	9 Sizes, 80 Seals (Nitrile, 90 Duro)	Cat Flanges
4C-4788	O-Ring Seal	10 Sizes, 125 Seals (Nitrile, 90 Duro)	Metric Fittings
9U-7804	O-Ring Seal	8 Sizes, 120 Seals (Nitrile, 75 Duro)	Air Conditioning Fittings (R134 Compatible)
4C-8253	O-Ring Seal	32 Sizes, 149 Seals (Silicone, 70 Duro)	Low-Pressure, High-Temperature Applications

Seals / O-Ring Materials

MATERIAL	HARDNESS	TEMP.	COMPATIBLE WITH	APPLICATIONS	NOT COMPATIBLE WITH
Ethylene Propylene Diene Modified (70) (EPDM)	70 Durometer	-55° – 135° C -67° – 275° F	Alcohols Automotive brake fluids Hot, cold water Ketones Ozone and sunlight Phosphate ester fluids Silicone fluids Some dilute acids Steam (200 Degree C max) Steam (400 Degree F max)	Ebullient cooled engine cooling systems	Aromatic fuels Diester lubricants Petroleum fluids
Fluorocarbon (75) (FKM)	75 Durometer	-40° – 175° C -40° – 350° F	Diester lubricants Halogenated hydrocarbons (above 100 Deg. C) Highly resistant to compression set Petroleum fluids Phosphate ester fluids Silicone fluids Some acids	High temperature applications requiring resistance to air, fuels, lubricants and hydraulic fluids	Amines Brake fluids Engine Coolant Fire Resistant Fluids Ketones Steam Water
Fluorocarbon (90) (FKM)	90 Durometer	-40° – 175° C -40° – 350° F	Diester lubricants Halogenated hydrocarbons (above 100 Deg. C) Highly resistant to compression set Petroleum fluids Phosphate ester fluids Silicone fluids Some acids	High pressure, high temperature applications requiring resistance to air, fuels, lubricants and hydraulic fluids ORFS, STORS seals	Amines Brake fluids Engine Coolant Fire Resistant Fluids Ketones Steam Water

MATERIAL	HARDNESS	TEMP.	COMPATIBLE WITH	APPLICATIONS	NOT COMPATIBLE WITH
Highly Saturated Nitrile (78) (HNBR)	78 Durometer	-40° – 121° C -40° – 275° F	Abrasion resistant Diesel fuels Diester lubricants Ozone Petroleum oils, greases Refrigerant HFC - 134a (Non-Freon) Silicone fluids Steam Water base engine coolants	Automotive air conditioner seals High temperature flex boot seals High temperature power steering seals Higher temperature hydraulic seals Middle cylinder liner seals	Aromatic and oxygenated gasolines Automotive and aircraft brake fluids Chlorinated hydrocarbons Ethers Ketones Phosphate ester fluids
Nitrile (60)	60 Durometer	-40° – 100° C -40° – 212° F	Alpha-Olefin base synthetic lubricants Ethylene Glycol Petroleum base lubricants Silicone oils and greases Water, water base engine coolants	Ambient temperature fuel handling High and low pressure LPG service Hydraulic fluids Power steering seals Radiator thermostat seals	Automotive and aircraft brake fluids High levels of ozone Ketones Phosphate ester fluids UV Light
Nitrile (70)	70 Durometer	-40° – 100° C -40° – 212° F	Alpha-Olefin base synthetic lubricants Ethylene Glycol Hydrocarbon fuels Petroleum base lubricants Silicone oils and greases Water, water base engine coolants	Ambient temperature fuel handling High and low pressure LPG service Hydraulic fluids Power steering seals Radiator thermostat seals	Acetone Automotive and aircraft brake fluids Chlorinated hydrocarbons High levels of ozone Ketones Nitro hydrocarbons Phosphate ester fluids Strong acids UV light

Seals / O-Ring Materials

MATERIAL	HARDNESS	TEMP.	COMPATIBLE WITH	APPLICATIONS	NOT COMPATIBLE WITH
Nitrile (90)	90 Durometer	-40° – 100° C -40° – 212° F	Abrasion resistant Alpha-Olefin base synthetic lubricants Ethylene Glycol Hydrocarbon fuels Petroleum base lubricants Silicone oils and greases Water, water base engine coolants ORFS, STORS seals	Ambient temperature fuel handling High and low pressure LPG service Hydraulic fluids (to 10,335 kPa/1500 psi) Power steering seals Radiator thermostat seals	Automotive and aircraft brake fluids High levels of ozone Ketones Phosphate ester fluids Strong acids UV light
Polyacrylic (75) (ACM)	75 Durometer	-12° – 135° C +10° – 275° F	Excellent resistance to oxidation Excellent resistance to ozone Excellent resistance to sunlight & UV light Petroleum base fluids Transmission fluids Type "R" power steering fluid	Power steering seals Transmissions	Aromatic hydrocarbons Brake fluids Chlorinated hydrocarbons Ethylene Glycol Methanol Other alcohols Phosphate ester fluids Water or steam
Silicone (70)	70 Durometer	-46° – 150° C -50° – 300° F	Air Diacetone alcohol Ethylene glycol Extreme high/low temperatures High aniline point oil Iso-butyl alcohol Ozone & UV light Polyglycol	Electrical system seals High temperature air seals High temperature static grease seals	Acetone Aromatic hydrocarbons EP oil Fuel oil Gasoline Ketones Low aniline point oils Petroleum oils Steam & hot water
Urethane (90)	90 Durometer	-40° – 93° C -40° – 200° F	Ozone Petroleum base lubricants and hydraulic fluids/fuels UV light	Brake seals Hydraulic cylinder seals	Water Water base hydraulic fluids

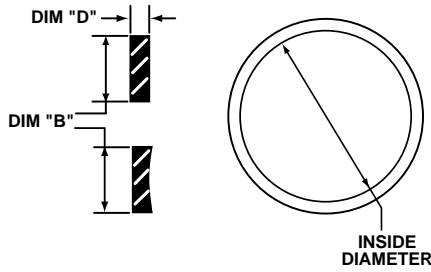

Backup Rings

DASH SIZE	DIMENSION "B" RADIAL HEIGHT (MM)	RING INSIDE DIAMETER (MM)	DIMENSION "D" AXIAL WIDTH (MM)	PART NUMBER	MATERIAL TYPE
	1.00	11.00	0.60	115-6880	PTFE 55 (Duro Hardness)
	1.10	7.3	0.70	115-9530	Plastic
	1.22	6.60	1.30	147-6604	PTFE 65 (Duro Hardness)
		8.20	1.30	147-6605	PTFE 65 (Duro Hardness)
		196.83	3.02	126-4040	PTFE 65 (Duro Hardness)
		241.30	3.02	126-4004	PTFE 65 (Duro Hardness)
	1.26	12.57	1.55	156-2850	PTFE 60 (Duro Hardness)
	1.27	32.20	1.24	085-7530	PTFE 55 (Duro Hardness)
	1.35	5.94	1.23	126-5984	Plastic
		6.30	1.42	4T-5070	PTFE 65 (Duro Hardness)
		6.75	1.23	126-5985	Plastic
7.90		1.42	4T-5071	PTFE 65 (Duro Hardness)	
-011	1.35	8.31	1.19	187-3513	Nitrile Rubber 90 (Duro Hardness)
	1.35	8.31	1.23	3E-6017	PTFE 65 (Duro Hardness)
		9.72	1.23	6E-0381	PTFE 55 (Duro Hardness)
		9.90	1.23	030-0167	PTFE 65 (Duro Hardness)
		9.91	1.23	109-6925	Plastic
		11.56	0.74	179-7257	PTFE 65 (Duro Hardness)
		13.16	0.74	161-6161	PTFE 65 (Duro Hardness)
		13.16	1.22	100-7000	PTFE 55 (Duro Hardness)
		13.16	1.22	6V-6923	PTFE 55 (Duro Hardness)
		13.16	1.23	109-6926	Plastic
		14.73	0.74	169-1616	PTFE 65 (Duro Hardness)
		14.73	1.22	6V-6924	PTFE 55 (Duro Hardness)
		16.33	0.74	169-1617	PTFE 65 (Duro Hardness)
		16.33	0.74	161-6160	Plastic
		16.33	1.23	109-6927	Plastic
		21.08	1.23	4T-4953	Plastic
		22.68	1.25	9T-1243	PTFE 55 (Duro Hardness)
		24.38	1.23	9T-4518	PTFE 65 (Duro Hardness)
-022	1.35	25.68	1.19	115-9864	Nitrile Rubber 90 (Duro Hardness)
-023	1.35	27.43	1.19	115-9865	Nitrile Rubber 90 (Duro Hardness)
	1.40	9.20	0.50	117-0355	PTFE 55 (Duro Hardness)
		11.10	0.71	187-0541	PTFE 65 (Duro Hardness)
		11.20	0.50	117-0357	PTFE 55 (Duro Hardness)
		12.74	0.69	185-2327	PTFE 65 (Duro Hardness)

Seals / Backup Rings

DASH SIZE	DIMENSION "B" RADIAL HEIGHT (MM)	RING INSIDE DIAMETER (MM)	DIMENSION "D" AXIAL WIDTH (MM)	PART NUMBER	MATERIAL TYPE
	1.40	13.20	0.70	192-7118	PTFE 55 (Duro Hardness)
		15.20	0.50	117-0353	PTFE 55 (Duro Hardness)
		16.00	0.69	9J-6367	PTFE 60 (Duro Hardness)
		28.4	1.40	179-4177	Plastic
		36.2	1.40	179-4178	Plastic
	1.45	11.4	1.00	149-4076	Plastic
		13.0	1.00	149-4077	Plastic
		13.1	1.40	179-4176	Plastic
	1.50	10.00	1.00	117-0356	PTFE 55 (Duro Hardness)
	1.60	6.25	1.23	186-2488	PTFE 65 (Duro Hardness)
		11.00	1.23	186-2487	PTFE 65 (Duro Hardness)
	1.75	24.50	0.60	180-7460	PTFE 65 (Duro Hardness)
	1.90	26.20	0.60	180-7459	PTFE 65 (Duro Hardness)
	1.99	11.27	1.52	6E-0382	PTFE 55 (Duro Hardness)
	2.00	26.00	1.52	6E-5662	PTFE 65 (Duro Hardness)
		29.20	1.52	6E-5663	PTFE 65 (Duro Hardness)
	2.10	21.80	1.00	115-7764	PTFE 55 (Duro Hardness)
	2.18	9.91	1.23	117-3584	PTFE 55 (Duro Hardness)
		11.48	1.23	117-3581	PTFE 55 (Duro Hardness)
		14.64	1.23	9T-1862	Plastic
		14.65	1.23	101-1983	PTFE 65 (Duro Hardness)
		15.47	1.22	9T-3342	Plastic
		16.26	0.74	194-3871	PTFE 65 (Duro Hardness)
		17.40	1.52	4T-5072	PTFE 65 (Duro Hardness)
		17.83	.74	194-3872	PTFE 65 (Duro Hardness)
		19.43	.74	194-3873	PTFE 65 (Duro Hardness)
	-117	2.18	21.11	1.19	5P-7857
	2.18	22.30	1.52	4T-5073	PTFE 65 (Duro Hardness)
		23.88	1.52	4T-6977	PTFE 65 (Duro Hardness)
-119	2.18	24.28	1.19	5P-7858	Nitrile Rubber 90 (Duro Hardness)
	2.18	25.48	1.52	4T-5074	PTFE 65 (Duro Hardness)
-121	2.18	27.46	1.19	183-9524	Nitrile Rubber 90 (Duro Hardness)
	2.18	29.08	1.23	1U-4835	PTFE 55 (Duro Hardness)
-123	2.18	30.63	1.19	183-9525	Nitrile Rubber 90 (Duro Hardness)
	2.18	36.63	1.52	4T-5075	PTFE 65 (Duro Hardness)
		44.50	1.52	6E-5418	PTFE 65 (Duro Hardness)
		47.67	1.52	6E-5417	PTFE 65 (Duro Hardness)
		48.08	1.19	183-9523	Nitrile Rubber 90 (Duro Hardness)
		52.45	1.52	6E-5416	PTFE 55 (Duro Hardness)
-164	2.18	159.21	1.14	177-1812	Nitrile Rubber 90 (Duro Hardness)
	2.20	30.60	1.50	193-4727	PTFE 55 (Duro Hardness)
	2.21	31.83	1.57	9T-1558	PTFE 65 (Duro Hardness)
	2.40	35.20	1.00	179-9014	PTFE 65 (Duro Hardness)
		127.73	1.09	173-3237	PTFE 65 (Duro Hardness)
	2.44	328.05	0.00	122-0440	Urethane 90 (Duro Hardness)

Seals / Backup Rings

DASH SIZE	DIMENSION "B" RADIAL HEIGHT (MM)	RING INSIDE DIAMETER (MM)	DIMENSION "D" AXIAL WIDTH (MM)	PART NUMBER	MATERIAL TYPE
	2.45	22.20	1.40	192-7114	PTFE 55 (Duro Hardness)
	2.58	35.88	1.22	170-2415	PTFE 65 (Duro Hardness)
	2.58	76.55	1.09	175-7908	PTFE 65 (Duro Hardness)
		114.41	1.09	175-7914	PTFE 65 (Duro Hardness)
		120.76	1.09	175-7915	PTFE 65 (Duro Hardness)
	2.65	16.30	1.23	3G-5233	PTFE 65 (Duro Hardness)
	2.68	63.0	1.40	180-5049	Plastic
	2.77	41.35	1.57	8J-5472	PTFE 55 (Duro Hardness)
		44.53	1.58	8J-3817	PTFE 55 (Duro Hardness)
	2.90	75.92	1.09	8J-2574	Urethane 90 (Duro Hardness)
		134.30	1.09	8C-3847	Nylon
		183.40	1.00	4T-3107	Urethane 90 (Duro Hardness)
		208.60	1.00	1U-1101	Urethane 90 (Duro Hardness)
		259.20	1.00	3G-6857	Urethane 90 (Duro Hardness)
		271.80	1.09	9X-4596	Urethane 90 (Duro Hardness)
	2.98	22.40	1.27	179-0795	PTFE 65 (Duro Hardness)
-228	3.00	57.71	1.09	9X-7552	Nitrile Rubber 90 (Duro Hardness)
-263	3.00	84.61	1.09	5P-3235	Nitrile Rubber 90 (Duro Hardness)
	3.00	99.70	1.09	168-2271	Urethane 90 (Duro Hardness)
		114.00	3.00	144-0243	Nylon
-265	3.00	197.31	1.09	5J-6444	Nitrile Rubber 90 (Duro Hardness)
	3.02		1.23	9T-3340	Plastic
		19.45	1.23	183-8068	PTFE 65 (Duro Hardness)
		25.81	1.22	9T-0118	PTFE 55 (Duro Hardness)
		41.28	1.57	4T-5076	PTFE 65 (Duro Hardness)
		44.48	1.52	3G-9725	Nylon
		45.00	1.22	6V-6793	PTFE 60 (Duro Hardness)
		104.83	1.17	6D-6783	PTFE 55 (Duro Hardness)
		3.10	79.8	4.60	125-7002
	127.00		1.25	111-8817	PTFE 55 (Duro Hardness)
	3.92	131.46	1.52	148-6560	PTFE 65 (Duro Hardness)
		156.86	1.52	149-2092	PTFE 65 (Duro Hardness)
	4.01	258.63	1.73	7X-4757	Nylon
	4.10	48.00	1.30	195-2996	Nitrile Rubber 90 (Duro Hardness)
	4.12	150.51	1.52	162-7209	PTFE 60 (Duro Hardness)
		169.56	2.02	162-7210	PTFE 60 (Duro Hardness)
	4.17	169.57	1.78	8J-1666	Nylon
	4.22	200.91	1.78	8J-8827	Nylon
	4.30	129.91	1.52	8J-1689	Urethane 90 (Duro Hardness)
		174.25	1.50	1U-1738	Urethane 90 (Duro Hardness)
		224.75	1.52	1U-3173	Urethane 90 (Duro Hardness)
		243.75	1.52	1U-3307	Urethane 90 (Duro Hardness)
		256.40	1.52	1U-1770	Urethane 90 (Duro Hardness)
		281.70	1.50	1U-1626	Urethane 90 (Duro Hardness)
		300.64	1.50	8T-6926	Urethane 90 (Duro Hardness)

Seals / Backup Rings

DASH SIZE	DIMENSION "B" RADIAL HEIGHT (MM)	RING INSIDE DIAMETER (MM)	DIMENSION "D" AXIAL WIDTH (MM)	PART NUMBER	MATERIAL TYPE	
	4.30	307.00	1.52	1U-3383	Urethan 90 (Duro Hardness)	
		312.40	1.50	121-4161	Nitrile Rubber 90 (Duro Hardness)	
		352.00	1.52	4T-4127	Urethane 90 (Duro Hardness)	
		415.50	1.52	151-8413	Urethane 90 (Duro Hardness)	
	4.32	199.52	1.52	3G-3747	Urethane 90 (Duro Hardness)	
	4.35	205.65	2.44	108-0122	Urethane 90 (Duro Hardness)	
		265.52	2.44	108-0129	Urethane 90 (Duro Hardness)	
	4.60	118.20	1.50	9X-7279	Urethane 90 (Duro Hardness)	
	-346	4.65	105.49	1.65	8J-3752	Nitrile Rubber 90 (Duro Hardness)
		4.65	111.84	1.52	9X-7278	Urethane 90 (Duro Hardness)
167.28			1.52	9X-7273	Urethane 90 (Duro Hardness)	
338.80			1.52	9X-4595	Urethane 90 (Duro Hardness)	
4.75		127.00	2.75	184-0844	PTFE 65 (Duro Hardness)	
4.76		140.49	2.44	184-0843	PTFE 65 (Duro Hardness)	
5.00		35.00	3.00	153-8586	PTFE 55 (Duro Hardness)	
		40.00	3.00	153-8584	PTFE 55 (Duro Hardness)	
		140.00	2.50	111-8816	PTFE 55 (Duro Hardness)	
5.40		450.00	2.40	149-2696	Urethane 90 (Duro Hardness)	
5.80		170.00	2.50	180-5050	Plastic	
-440	6.00	172.06	2.61	065-7978	Nitrile Rubber 90 (Duro Hardness)	
	6.00	353.20	2.45	4T-5929	Urethane 90 (Duro Hardness)	
	6.23	220.89	2.40	3E-6783	Urethane 90 (Duro Hardness)	
		227.20	2.40	3E-6784	Urethane 90 (Duro Hardness)	
	6.25	239.20	2.40	121-4160	Nitrile Rubber 90 (Duro Hardness)	
		315.48	2.44	120-5350	Urethane 90 (Duro Hardness)	
	6.40	265.00	2.40	3E-6795	Urethane 90 (Duro Hardness)	
	7.06	56.69	2.82	170-6712	PTFE 65 (Duro Hardness)	
	8.45	63.68	4.00	8C-9140	Urethane 90 (Duro Hardness)	
	9.09	101.19	4.27	7J-3864	Urethane 90 (Duro Hardness)	
		126.59	4.27	9J-2548	Urethane 90 (Duro Hardness)	
		139.29	4.27	8J-9450	Urethane 90 (Duro Hardness)	
		154.86	4.27	7J-3866	Urethane 90 (Duro Hardness)	
		183.75	4.27	4T-4804	Urethane 90 (Duro Hardness)	
		190.09	4.27	7J-3867	Urethane 90 (Duro Hardness)	
		196.45	4.27	121-4166	Urethane 90 (Duro Hardness)	
		215.49	4.27	8J-9916	Urethane 90 (Duro Hardness)	
		221.85	4.27	6E-0251	Urethane 90 (Duro Hardness)	
		266.29	4.27	4T-4807	Urethane 90 (Duro Hardness)	
	9.16	292.45	3.90	121-4164	Urethane 90 (Duro Hardness)	
		317.85	3.90	115-2136	Urethane 90 (Duro Hardness)	
10.08	164.69	5.64	9J-1186	Urethane 90 (Duro Hardness)		
11.43	129.72	3.05	3G-6536	Nylon		
14.25	238.28	3.05	7J-9062	Nylon		

V-BELTS

V-Belt Sizing Guide	488
Non-Cog Type	489
Cog Type	490

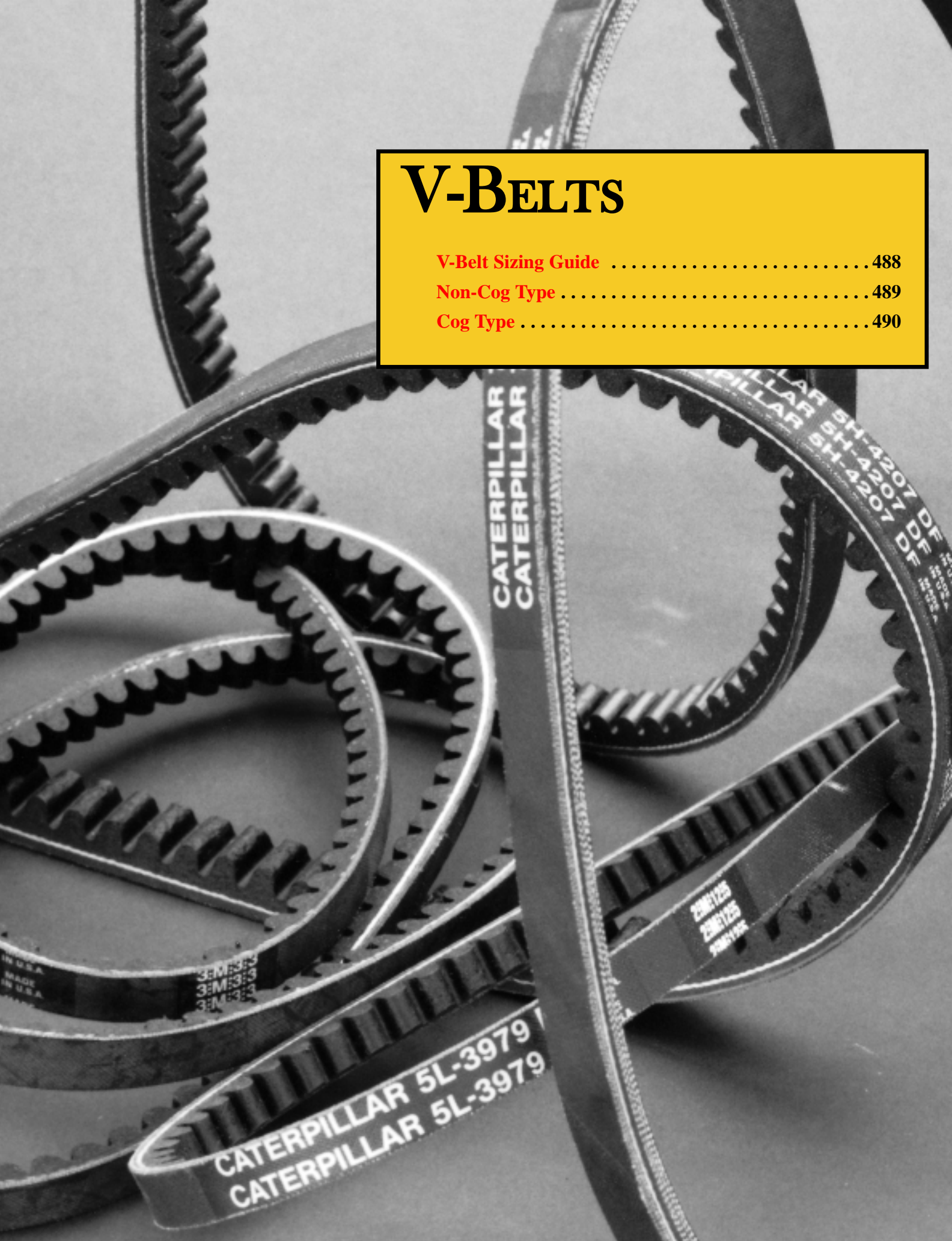

V-Belts



V-Belt Sizing Guide

- Belt size refers to the pulley groove width (B) for belts under and equal to 1/2".
- Belt size refers to the belt top width (A) for belts over 1/2".

BELT SIZE (in)	(mm)	A		B	
		BELT TOP WIDTH (in)	(mm)	PULLEY GROOVE WIDTH (in)	(mm)
3/8	9.5	0.422	10.72	0.380	9.65
1/2	12.7	0.547	13.89	0.500	12.70
11/16	17.5	0.688	17.48	0.625	15.88
3/4	19.1	0.750	19.05	0.690	17.53
15/16	23.8	0.938	23.83	0.878	22.30
1 1/16	27.0	1.062	26.97	1.003	25.48
1 1/4	31.8	1.297	32.94	1.253	31.83

V-Belt Maintenance Tips

Keep the V-Belts on your engine in good condition. V-Belt failure can cause malfunctions of the charging system and overheating. Regularly do the following:

- Check for cracked, worn, or frayed belts. On matched belt sets, always replace the complete set. If just one belt is bad, uneven load on belts, pulleys, bearings, and shafts can occur.
- Check pulley grooves to make sure they are not worn, damaged, or aligned incorrectly. Poor belt to pulley contact will result in rapid wear and short life.

Using a tension gauge, check belt tension after installation and at every oil change. Adjust to ensure proper belt seating.

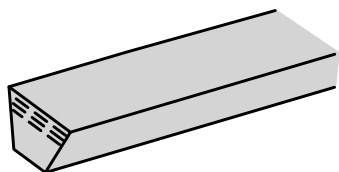

Non-Cog Type

SAE effective length equals:

- Outer circumference minus 0.38" (9.65 mm) for 3/8" and 1/2" belt sizes.
- Outer circumference minus 0.57" (14.48 mm) for 11/16" and larger belt sizes.

SIZE (in) (mm)		LENGTH (in) (mm)		SET PART NUMBER	SINGLE BELT NUMBER
3/8	9.6	43.5	1105	9Y-7159 (2)	2W-2531
1/2	12.7	31.0	787		7C-2163
		40.0	1016		7C-8236
		41.5	1054		1P-9744
		43.0	1092		4N-7335
		43.5	1105	9N-1330 (3)	9N-1329
		44.0	1118		1N-3743
		45.0	1143	9N-1322 (2)	2P-6820
		46.0	1168		2P-6819
		46.5	1181		4N-9891
					9Y-1131
		47.0	1194		2P-6818
		47.5	1206		1W-2934
		48.5	1232	9N-1323 (2)	1P-3085
		49.0	1245		4P-0454
		49.5	1257	4N-8580 (2)	1P-4334
		50.0	1270	9L-6128 (2)	3P-0130
		50.5	1283		2P-6212
		51.0	1295		9Y-6117
		51.5	1308	4N-8597 (2)	4N-6130
		52.5	1334	7W-3896 (2)	2P-4191
		53.0	1346		068-0610
		54.0	1372	9L-6126 (2)	9L-6125
				9L-4322 (3)	9L-6125
		55.0	1397		8N-0503
		55.5	1410		2P-4685
				114-3542 (3)	2S-2743
		56.5	1435		4N-7610
57.5	1460	7N-8518 (2)	2P-4230		
61.0	1549	9N-3483 (2)	1P-6868		
62.5	1588	6N-0724 (2)	1P-4313		
63.0	1600		2P-6161		
		068-8546 (2)	9L-4479		
65.5	1664	9L-6130 (2)	2P-8720		
		9L-2850 (3)	2P-8720		
66.5	1689		1N-4556		
67.5	1714		2P-6532		
71.0	1803		1W-6039		

SIZE (in) (mm)		LENGTH (in) (mm)		SET PART NUMBER	SINGLE BELT NUMBER
1/2	12.7	72.0	1829		7W-5207
		73.0	1854		1N-3795
		74.0	1880		1W-9693
		78.0	1981	4P-5436 (2)	8M-0760
		82.0	2083		9Y-1954
		84.0	2134		7E-3898
		86.0	2184		1W-8908
		90.0	2286		4W-5825
		90.1	2288		117-0030
		11/16	17.5	60.0	1524
65.5	1664				7C-9001
				9N-1327 (2)	9N-1320
				9N-2802 (3)	9N-1320
68.5	1740				6N-7721
90.0	2286			1W-8043 (2)	
15/16	23.9			54.5	1384
		57.5	1460	9Y-0291 (2)	9Y-0290
		64.5	1638	6N-3637 (2)	6N-3636
		79.5	2019	5R-7276 (2)	
				7M-0305 (3)	
		82.0	2083	6L-1987 (2)	

Number in parentheses () after the set part number indicates the quantity of belts per set.

V-Belts

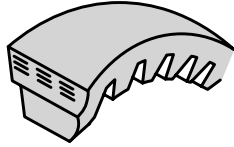

Cog Type

SAE effective length equals:

- Outer circumference minus 0.38" (9.65 mm) for 3/8" and 1/2" belt sizes.
- Outer circumference minus 0.57" (14.48 mm) for 11/16" and larger belt sizes.

SIZE (in) (mm)	LENGTH (in) (mm)	SET PART NUMBER	SINGLE BELT NUMBER
3/8 9.6	29.0 737	6L-6213 (2)	
	36.0 914	1N-8405 (2)	
	40.0 1016	7L-4528 (2)	
	49.5 1257	2N-0159 (2)	1N-9310
	50.5 1283	7N-3157 (2)	
	51.5 1308	7L-5091 (2)	
	55.5 1410	7N-3158 (2)	
1/2 12.7	28.0 711		4H-0552
	29.0 737		2L-1478
	31.5 800	9L-2267 (2)	
	33.0 838		004-0909
	33.5 851		061-8384
	34.0 864		036-6775
	34.5 876		7E-0744
	35.0 889		030-3289
	35.5 902		037-2448
	36.0 914		036-2176
	37.0 940		030-3291
	37.5 952	5L-3980 (2)	5L-3979
	39.0 991	2W-0237 (2)	1N-4635
	39.5 1003		8N-3504
	40.0 1016		9L-4896
	40.5 1029		001-5645
	41.0 1041	9L-1125 (2)	9L-1126
	41.5 1054	9L-4226 (2)	4M-6291
	42.5 1080	2N-1493 (2)	061-7139
	43.0 1092	9L-4013 (2)	
	43.5 1105	1N-4223 (2)	1W-5555
	44.5 1130	5L-3826 (2)	5L-3834
	45.0 1143	3N-4658 (2)	4L-6060
	46.0 1168	6L-7954 (2)	9M-1091
	47.0 1194		8L-8646
	47.5 1206	6L-8161 (2)	6L-3408
	48.0 1219	9L-0619 (2)	9L-2248
	48.5 1232		6N-3113
	49.0 1245	5N-6350 (2)	3K-3408
	50.0 1270	8L-8984 (2)	5M-8137
	50.5 1283	5L-4995 (2)	5L-4996

SIZE (in) (mm)	LENGTH (in) (mm)	SET PART NUMBER	SINGLE BELT NUMBER
1/2 12.7	51.5 1308	3N-1491 (2)	5M-8135
		9S-6760 (3)	5M-8135
	52.0 1321	9L-0895 (2)	9L-0894
		9L-1554 (3)	9L-0894
	52.5 1334	3S-8447 (2)	3S-8448
		3N-4079 (3)	3S-8448
	53.0 1346	5L-3308 (2)	5L-3307
	53.5 1359	4N-8771 (2)	3S-6272
		8L-4526 (3)	3S-6272
	54.0 1372		061-7140
	55.0 1397	9L-1557 (2)	9L-1553
		9L-4034 (3)	9L-1553
	55.5 1410	2S-2756 (2)	2S-2743
	56.0 1422	5N-9303 (2)	3S-3964
	57.0 1448	9L-1127 (2)	9L-1128
		9L-3047 (3)	9L-1128
	57.5 1460	4W-6025 (2)	3S-3961
	58.0 1473	9L-1226 (2)	7L-5001
	58.5 1486	2S-9779 (2)	2S-5218
		5N-6098 (3)	2S-5218
	59.0 1499	2N-2297 (2)	6L-5115
		6L-5117 (3)	6L-5115
	59.5 1511	7E-5799 (3)	7E-5798
	60.0 1524	9L-1106 (2)	2S-9506
		9L-3599 (3)	2S-9506
	61.0 1549	6L-4100 (2)	5N-4692
		5N-4693 (3)	5N-4693
	62.0 1575	8M-8341 (2)	8M-8336
		9L-4325 (3)	8M-8336
	63.0 1600	9L-4480 (3)	9L-4479
	64.0 1626	8M-8340 (2)	8M-8335
		9L-3474 (3)	
65.0 1651	8S-5154 (2)	4S-6209	
	5N-4876 (3)	4S-6209	
65.5 1664	1S-4700 (2)	1S-4699	
66.5 1689	4W-8729 (2)	5S-5249	
67.0 1702	9L-1129 (2)	9L-1130	
	9L-2527 (3)	9L-1130	

Number in parentheses () after the set part number indicates the quantity of belts per set.

Cog Type

SIZE (in) (mm)		LENGTH (in) (mm)		SET PART NUMBER	SINGLE BELT NUMBER
1/2	12.7	68.0	1727	1S-1187 (2)	3S-9652
				3S-9653 (3)	3S-9652
		68.5	1740	4W-8655 (2)	
		69.0	1753	4W-8662 (2)	5S-5052
				9L-2526 (3)	5S-5052
		70.0	1778	2S-2481 (2)	
				9L-5280 (3)	
		70.5	1791	2P-5618 (2)	
				4N-6999 (3)	
		71.0	1803	1S-1208 (2)	6F-2590
		71.5	1816		7E-6158
		72.0	1829	6L-6557 (2)	
				9L-2520 (3)	
		72.5	1842	1S-4760 (2)	1S-4761
				5N-2088 (3)	1S-4761
		73.0	1854	9L-6080 (3)	8N-2814
		74.0	1880	9L-1630 (3)	9L-1629
				7L-5093 (4)	9L-1629
		75.0	1905		5M-0923
		75.5	1918	6N-3843 (2)	1N-4555
76.5	1943	9L-2350 (3)			
77.0	1956		8M-3092		
77.5	1968	9L-4266 (3)			
79.0	2007	7E-6192 (2)			
11/16	17.5	35.0	889		1L-6557
		42.5	1080		6B-5653
		45.5	1156		8P-3064
		48.5	1232		6B-2746
		49.0	1245	9L-6654 (2)	9L-6653
		51.0	1295	9L-0361 (2)	5B-8473
		51.5	1308		6N-0341
		53.5	1359	7N-3949 (2)	
				2N-8612 (3)	
		54.0	1372	8L-5137 (3)	
		55.5	1410	7L-7020 (3)	
		56.0	1422	4N-8217 (2)	4N-8216
		57.0	1448	9L-6640 (2)	9L-6639
				9N-1324 (3)	9L-6639
		57.5	1460		6N-7135
		58.5	1486	4N-6373 (2)	
				9N-1325 (3)	4N-8220
		59.0	1499	9L-6642 (2)	9L-6641
		60.0	1524	4P-1667 (2)	
		61.0	1549	9L-6644 (2)	9L-6643

SIZE (in) (mm)		LENGTH (in) (mm)		SET PART NUMBER	SINGLE BELT NUMBER
11/16	17.5	61.0	1549	6N-6798 (3)	9L-6643
				6N-9159 (4)	9L-6643
61.5	1562	4N-2532 (2)	4N-2531		
		5N-0414 (3)	4N-2531		
62.5	1588	9L-6646 (2)	9L-6645		
63.5	1613	8N-0539 (2)	6N-6657		
		6N-6656 (3)	6N-6657		
		6N-6653 (4)	6N-6657		
64.5	1639	9L-6724 (2)			
		4N-6423 (3)			
		6N-0388 (4)			
65.5	1664	4P-8397 (2)			
66.5	1689	9L-6648 (2)			
		6N-6652 (3)			
68.5	1740	9L-6650 (2)			
		6N-9158 (3)			
69.0	1752	7E-7646 (3)			
70.0	1778	3R-9346 (2)			
		6N-6655 (3)			
71.0	1803	3N-8848 (3)	4N-8221		
71.5	1816	9L-6652 (2)	9L-6651		
		5N-2346 (4)	9L-6651		
72.0	1829	5N-4751 (3)	6N-0073		
73.0	1854	9L-6725 (2)	4N-8277		
		4N-8278 (3)	4N-8277		
		7W-3222 (4)	4N-8277		
74.5	1892	6N-6651 (3)	6N-6650		
75.0	1905	3R-9090 (4)			
75.5	1918	6N-9144 (2)	4N-8219		
		4N-6302 (3)	4N-8219		
77.0	1956	4P-8087 (3)	4P-8088		
78.0	1981	6N-7053 (3)			
		1W-0422 (4)			
79.0	2007	4W-9051 (4)			
80.0	2032	7C-2500 (3)	7W-6129		
		4W-8510 (4)	7W-6129		
81.0	2057	8N-5509 (2)	6N-5338		
		6N-5337 (3)	6N-5338		
		7W-8137 (6)	6N-5338		
82.0	2083	7N-7055 (4)			
83.0	2108	7W-8135 (6)			
84.0	2134	1W-3711 (2)			
		4N-8198 (3)			
		8N-6710 (4)			

Number in parentheses () after the set part number indicates the quantity of belts per set.

V-Belts

Cog Type

SIZE (in) (mm)	LENGTH		SET PART NUMBER	SINGLE BELT NUMBER
	(in)	(mm)		
1 ¹ / ₁₆ 17.5	85.0	2159	7N-6602 (2)	7N-8538
			7N-4148 (4)	7N-8538
	86.0	2184	1N-3463 (2)	
	87.0	2210	7N-4829 (2)	7N-4828
			8N-6696 (4)	7N-4828
			8N-6702 (6)	7N-4828
	88.0	2235	1W-0530 (2)	
	89.0	2261	7N-9417 (2)	8N-6693
			8N-6708 (4)	8N-6693
			8N-6699 (6)	8N-6693
	90.0	2286	7W-5228 (6)	
	92.0	2337	1N-3713 (6)	
	94.0	2388	8N-6718 (4)	
			8N-6700 (6)	
	95.0	2413	5L-7426 (4)	
			7L-7882 (6)	
	96.0	2438	8N-6707 (4)	
			8N-6705 (6)	
	97.0	2464	8N-6713 (4)	
			8N-6711 (6)	
	98.0	2489	7N-3122 (5)	
	99.0	2515	4W-0752 (3)	
			7W-5229 (6)	
	102.0	2591	7N-3118 (5)	
	103.0	2616	1N-4480 (4)	
			1N-4097 (6)	
	105.0	2667	8N-6716 (6)	
	106.0	2692	8N-6720 (6)	
107.0	2718	7N-3120 (5)		
		1N-4095 (6)		
110.0	2794	8N-6694 (6)		
111.0	2819	1N-4098 (6)		
3/4 19.1	41.5	1054		5M-5344
	45.0	1143		5L-1584
	45.5	1156		9S-9010
	46.5	1181		1S-5138
	47.5	1206		5M-5345
	48.5	1232	5L-4660 (2)	3L-9717
	49.5	1257		8F-2434
	52.5	1334		7M-0169
	54.0	1372		3S-8402
	55.0	1397	7M-4691 (2)	5M-0924
	56.5	1435	7M-0298 (2)	
	57.0	1448		8M-3646

SIZE (in) (mm)	LENGTH		SET PART NUMBER	SINGLE BELT NUMBER
	(in)	(mm)		
3/4 19.1	58.0	1473		4M-9678
				3R-2689
	58.5	1486		
	59.5	1511		7M-3921
	60.0	1524	8S-3199 (2)	
	61.5	1562	7M-6104 (2)	3P-0025
	62.0	1575	7S-9807 (2)	4M-6292
	62.5	1588	2P-6142 (2)	
	63.0	1600	7M-6105 (2)	
	63.5	1613	1P-2423 (2)	1P-2421
	64.0	1626	7M-6100 (2)	
	64.5	1638	4S-7754 (2)	
	65.0	1651	7S-9811 (2)	5M-2733
	66.0	1676	7S-9860 (2)	7S-9859
	66.5	1689	8M-1714 (2)	8M-1715
			3N-8258 (3)	8M-1715
	67.0	1702	1S-1126 (2)	
	68.0	1727	5S-9078 (2)	
	69.0	1753	5S-9079 (2)	
	69.5	1765	7S-1690 (2)	
	70.0	1778	7S-9810 (2)	
	70.5	1791	5M-5343 (2)	
	71.0	1803	7M-5535 (2)	
			4N-4105 (4)	
	72.5	1842	9M-6933 (2)	
	73.0	1854	2P-6140 (2)	
	74.0	1880	2P-2357 (2)	2P-2356
	74.5	1892	6N-2348 (2)	
	76.0	1930	7S-8350 (2)	
	76.5	1943	8S-6178 (2)	9M-5146
	77.0	1956		9M-3633
	79.0	2007	5R-2455 (3)	4M-9072
79.5	2019	4N-4773 (4)		
80.0	2032	5S-0291 (3)		
81.0	2057	2S-8268 (3)		
82.0	2083	4N-1745 (3)	7M-7373	
83.0	2108	3S-9646 (3)	2S-5279	
86.0	2184	7N-7502 (2)	5S-1762	
1 ⁵ / ₁₆ 23.9	48.5	1232		5F-7676
	50.0	1270		5H-2896
	51.5	1308		5H-9857
	54.0	1372	7E-5097 (2)	
	55.0	1397	7E-5113 (2)	
	55.5	1410	7M-4711 (2)	
	56.0	1422	1S-1127 (2)	

Number in parentheses () after the set part number indicates the quantity of belts per set.

Cog Type

SIZE (in) (mm)		LENGTH (in) (mm)		SET PART NUMBER	SINGLE BELT NUMBER
1 ⁵ / ₁₆	23.9	57.0	1448	4N-6529 (2)	5L-9902
		58.5	1486	7M-4715 (2)	
		59.0	1499		8M-9708
		59.5	1511		4M-8218
		61.0	1549	2P-2369 (2)	3S-2347
		62.0	1575	8N-4128 (2)	5M-5347
		62.5	1588	2P-2696 (2)	
		63.0	1600	7M-4716 (2)	
		63.5	1613		6B-8536
		64.0	1626	2P-1388 (2)	2P-1272
		65.0	1651	7M-0981 (2)	
		66.0	1676	4N-3587 (2)	
				7M-7476 (3)	
		66.5	1689	7L-7099 (2)	
		67.0	1702	7M-7864 (3)	
		67.5	1714	5L-5015 (2)	2M-8183
		69.0	1753	9M-7221 (2)	
				2S-6913 (3)	
		69.5	1765	3P-0071 (2)	5H-4207
		70.0	1778	7M-4706 (2)	
		71.0	1803	7M-4707 (2)	
				5L-5656 (3)	
		71.5	1816	7M-4719 (2)	
		72.5	1842	7M-4705 (2)	
		73.0	1854	7M-4702 (2)	
		73.5	1867	3P-0098 (2)	
		74.0	1880	7M-0185 (2)	
		75.5	1918	8S-1475 (2)	
				7M-4947 (3)	
		76.0	1930	7M-4717 (2)	
		76.5	1943	7M-4703 (2)	
				7M-4704 (3)	
		77.0	1956	7M-4718 (2)	
		77.5	1968	5L-5014 (2)	
2S-6168 (3)					
78.5	1994	7M-4721 (2)			
79.0	2007	8M-0934 (2)			
80.0	2032	9M-7801 (2)			
		2S-5653 (3)			
81.0	2057	8M-8681 (2)			
		3S-7520 (3)			
		6N-1551 (4)			
83.0	2108	4S-9791 (3)			
85.0	2159	7M-4710 (2)			

SIZE (in) (mm)		LENGTH (in) (mm)		SET PART NUMBER	SINGLE BELT NUMBER
1 ⁵ / ₁₆	23.9	85.0	2159	2P-8624 (3)	
		86.0	2184	7C-3559 (2)	
		87.0	2210	2W-8951 (2)	
				7M-4701 (3)	
		88.0	2235	2W-6766 (2)	
		89.0	2261	2W-8952 (2)	2S-5279
				7N-3965 (4)	
		90.0	2286	1S-1207 (2)	
				6N-7575 (4)	
		92.0	2337	4W-7508 (2)	
		100.0	2540	7W-6471 (6)	
		102.0	2591	7W-1665 (4)	
		107.0	2718	4W-5091 (5)	
		113.0	2869	9Y-8467 (6)	
1 ¹ / ₁₆	26.9	45.5	1156		6B-1039
		49.0	1245		7B-4032
		50.0	1270		4F-7956
		52.5	1334		5H-4239
1 ¹ / ₈	28.6	41.5	1054		100-3725
		43.0	1093		7E-4841
1 ¹ / ₄	31.8	60.5	1537		7B-2774
		61.5	1562		8H-7180
		62.5	1588	5L-6672 (2)	
		65.0	1651	6L-6552 (2)	
		69.0	1753	7M-4948 (2)	
74.0	1880	7M-4953 (2)			
1 ³ / ₈	34.9	59.3	1506		114-6414

Number in parentheses () after the set part number indicates the quantity of belts per set.

A

Adapters - Backhoe Loader Front

Front Bucket Bolt-On Adapters 213

Adapters - Backhoe Loader Rear

Bolt-On Adapters 216-217

Weld-On Double Strap Adapters 216-217

Adapters - Loader

Bolt-On Center Adapters 304

Bottom Strap Adapters 305

Flushmount Adapters 305

Heavy Duty A.R.M. Adapters 306

Heavy Duty Adapters 306

One-Bolt Corner Adapters 304

Two Strap Adapters 306

Two-Bolt Corner Adapters 305

Upsize Bolt-On Center Adapters 307

Upsize One-Bolt Corner Adapters 307

Upsize Two Strap Adapters 308

Upsize Two-Bolt Corner Adapters 308

Adapters - Motor Grader

Graderbit System Adapters 310-312

Adapters - Scraper

Bolt-On Adapters 334

Air Intake Pipe Extensions 16

Air Intake and Exhaust Stack Clamps 17

Alarms

Back-up Alarm 429

Excavator Travel Alarm 429

Low Air Pressure Alarm 429

B

Batteries

Battery Load Tester 24

Battery Voltmeter 24

Coolant and Battery Tester 25,67

Digital Battery Analyzer 24

Dry Batteries 21

Premium High Output Batteries 20

Wet Batteries 22-23

Battery Cable Repair Kit 26

Battery Cable Terminals 25

Battery Ground Straps 26

Battery Saver and Cleaner 52

Beacon 429

Blades - Bulldozer

Angle Blade 223, 225-227

Cushion Blade 222, 231

Power Angle and Tilt Blade 223-225

Semi-U Blade 222, 224-231

Straight Blade 222, 224-226

Universal Blade 222, 226-231

Blades - Compactor

Cushion Blade 244

Power Angle and Tilt Blade 244

Semi-U Blade 244

Universal Blade 244

Bolts

12 Point Head Bolts (Inch) 339, 355

Cutting Edge Bolts 340, 368-369

Forcing Bolts (Inch) 339, 364

Forcing Bolts (Metric) 339, 364

Bolts (continued)

Hex Socket Head Screw Bolts (Inch)	339, 356-357
Hex Socket Head Screw Bolts (Metric)	339, 362-363
High Strength Phosphate and Oil Coated Bolts (Inch/Hex Head)	338, 342-349
Track Bolts	340, 365-366
Phosphate and Oil Coated Bolts (Inch / Hex Head / Coarse Thread (UNC))	338, 341-345
Phosphate and Oil Coated Bolts (Inch Hex Head / Fine Thread (UNF))	338, 346-349
Phosphate and Oil Coated Bolts (Metric / Hex Head / Coarse Thread (UNC))	338, 358-359
Self-Locking Bolts (Inch / Hex Head / Coarse Thread (UNC))	354
Split Master Link Bolts	340, 367
Track Bolts (Inch)	340, 365
Track Bolts (Metric)	340, 366
Zinc Dichromate Plated Bolts (Inch / Hex Head / Coarse Thread (UNC))	338, 350-353
Zinc Dichromate Plated Bolts (Metric / Hex Head / Coarse Thread (UNC))	338, 360-361
Booster Cables	27
Brake Cleaner	52
Brake Fluid	423
Buckets - Backhoe Loader Front	
General Purpose Bucket	212
Multi-Purpose Bucket	212
Buckets - Backhoe Loader Rear	
Extreme Service Bucket	214
Heavy Duty Bucket	214

Buckets - Backhoe Loader Rear (continued)

High Capacity Bucket	214
Standard Duty Bucket	214

Buckets - Excavator

200-Family, E-Family Excavator Buckets	260-268
300-Family, A-Series; E-Family; and 200-Family Excavator Buckets	260-268
300-Family, B-Series Excavator Buckets	254
Ditch Cleaning Bucket	254-257
Excavation Bucket	262, 263, 266-268
Extreme Service Excavation Bucket	260, 262-263, 267-268
Extreme Service Mass Excavation Bucket	261-263
Extreme Service Trenching Bucket	260, 262, 265-266, 268
General Purpose Bucket	254-258
Heavy Duty Bucket	254-258
Heavy Duty Rock Bucket	254-259
Light Excavation (Utility) Bucket	260, 262, 267-268
Mass Excavation Bucket	261-263
Rock Mass Excavation Bucket	261
Rock Ripping Bucket	254, 256, 261
Trenching Bucket	260, 262-263, 265-268

Buckets - Loader

General Purpose Excavating Bucket	278, 280-284
General Purpose Penetration Bucket	278, 280-284
Material Handling Bucket	278, 280-284
Modulok Rock Bucket	279-284
Multi-Purpose Bucket	278, 280-284
Excavation Bucket	259

Buckets - Loader (continued)

Extreme Excavation Bucket	259
Spade Rock Bucket	259
Rock Bucket	278, 280-284
Utility Bucket	279-284
Bulk Electrical Cable and Wire	38

C

Caterpillar Contour Series Seats	433
Cement	46
Circuit Tester	44
Cleaner Bars	
Compactor Cleaner Bars	251
Compactor Feet	
Bolt-On Soil Compactor Feet	250
Pin-On Soil Compactor Feet	251
Weld-On Soil Compactor Feet	250
Component Cleaner	52
Compounds	
Heat Sink Compound	56
High Temperature Anti-Seize Compound	56
O-Ring Compound	55
Conduits	40
Continuity Tester/Flashlight	44
Control Knobs	432
Coolant Conditioner Test Kit	67
Coolant and Battery Tester	25, 67
Coolants	
Diesel Engine Antifreeze/Coolant - DEAC	65
Extended Life Coolant - ELC	64
Supplemental Coolant Additives - SCA	65

Cooling System Cleaner

Cooling System Cleaner - Quick Flush	66
Cooling System Cleaner - Standard Type	66
Corner Protectors - Loaders	300
Crimping Tools	43
Cutting Edges - Backhoe Loader Front	
Front Bucket Bolt-On Edges	213
Cutting Edges - Backhoe Loader Rear	
Rear Bucket Base Edge and Corners	215
Cutting Edges - Compactor	
Cutting Edges	245-246
Cutting Edges - Loader	
A.R.M. Bolt-On Edges	285-290
Heavy Duty Bolt-On Edges	285-290
Standard Bolt-On Edges	285-290
Cutting Edges - Motor Grader	
Curved Cutting Edges	313-318
Flat Cutting Edges	313, 316-319
Serrated Cutting Edges	313, 315, 317-319
Cutting Edges - Scraper	
Integrated Tooth Cutting Edges	334
Level Cut Arrangement	332
Scraper Cutting Edges	332
Stinger Arrangement	332

D

Depend No-Mix Adhesive	46
Deutsch (DT) Style Connector Service Kits	
Deutsch (DT) Style Connector Service Kit	42
Digital Tachometer	426

Index

E

Electrical Conduit Field Repair Fasteners . . .	40
Electrical Terminal Kit	39
Electrical Terminals	38
Emergency Jump Start Receptacle Assemblies	28
Emergency Start System	27
End Bits - Bulldozer	
Extended Wear Life End Bits	232-238
Finish Dozing End Bits	232-238
General Duty End Bits	232-238
Utility End Bits	232-238
End Bits - Compactor	
Finish Dozing End Bits	247-248
General Duty End Bits	247-248
End Bits - Motor Grader	
Moldboard End Bits	320
Overlay End Bits	321-322
Ether Starting Cylinder	55
Exhaust Pipe Extensions	
45° Outlet (B)	14
45° Square Cut Outlet (D)	14-15
Radial Square Cut Outlet (C)	14
Straight Pipe (A)	14

F

Fast Cure Epoxy Mixercup Kit	50
Field Soldering Iron Group	43
Filters	
Air Filter Service Indicators	207
Filter Cutting Tool	209
Filters	70
High Efficiency Hydraulic Cartridge Filters . . .	208

Filters (continued)

High Efficiency Hydraulic Spin-on Filters	209
Ultra High Efficiency Radial Seal Filters	207
Form-A-Gasket Sealant - #1, #2, #3	48
Fuel Tank Repair	47
Fuel Water Separator	432
Fuse Holders	
Fuse Holders and Puller	37
Fuses	35-36

G

Gasket Maker	48
Glass Cleaner	52
GraderBit Systems	
Penetration Bit Arrangement	310
Sharp Bit Arrangement	310
Standard Bit Arrangement	310
Wide Bit Arrangement	310
Greases	
Arctic Platinum Grease	422
Auto-Lube Grease #1	423
Desert Gold Grease	422
Dielectric Tune-Up Grease	419
High Vacuum Grease	419
Multipurpose Lithium Grease - MPG	420
Multipurpose Lithium Grease - MPGM	420
Water and Temperature Resistant Grease . . .	421
White Lithium Assembly Grease	421

H

Hardware Bin Kits and Shop/Field Kits	402
High Strength Thread Lock	51

Horns

Air Horn	429
Forward Warning Horns	429

Hose Clamps

Heavy Duty Hose Clamps	398
Hose Clamps	398
Hose Clamps (Uniform Load)	398

I

Infrared Thermometer	67
----------------------	----

L

Lamps

Composite Halogen Lights	29
Dash Lamps	34
LED Lights	31
Miniature Electrical Lamps	32
Sealed Beam Electrical Lamps	30
Stop/Tail Lamps	33

Lifting Eyebolts

Lifting Eyebolts (Inch)	385
Lifting Eyebolts (Metric)	385

Liquid Gasket	48
---------------	----

Lubricants

Bearing Lubricant	417
Camshaft Break-In Lubricant	417
Chain and Cable Lubricant	418
Dry Film Lubricant	418
Molykote Paste Lubricant	418
Rubber Lubricant	416
Silicone Lubricant	417

M

Maintenance Tips For Cutting

Edge Hardware	369
Manifold Sealant	51
Master Padlocks	435
Mineral Spirits	53
Mud Flaps	430
Mufflers	4-6

N

Nuts

Cutting Edge Nuts	377
Hex Jam Nuts (Inch / Hex Head / Coarse Thread (UNC) / Non-Hardened)	373
Hex Jam Nuts (Inch / Hex Head / Fine Thread (UNF) / Non-Hardened)	373
Phosphate and Oil Coated Nuts (Inch / Hex Head / Coarse Thread (UNC) / Hardened)	370
Phosphate and Oil Coated Nuts (Inch / Hex Head / Fine Thread (UNF) / Hardened)	370
Phosphate and Oil Coated Nuts (Metric / Hex Head / Hardened)	374
Self-Locking Nuts (Inch / Hex Head / Coarse Thread (UNC) / Hardened)	371
Self-Locking Nuts (Inch / Hex Head / Fine Thread (UNF) / Hardened)	371
Self-Locking Nuts (Metric / Hex Head Coarse Thread UNC / Hardened)	375
Self-Locking Nuts — Plastic Insert (Inch / Hex Head / Coarse Thread (UNC) / Zinc Dichromate Plated / Hardened)	372
Track Nuts (Inch)	376
Track Nuts (Metric)	376
Zinc Dichromate Plated Nuts (Inch / Hex Head / Coarse Thread (UNC) / Hardened)	370

Index

Nuts (continued)

Zinc Dichromate Plated Nuts (Metric / Hex Head / Hardened)	374
Zinc Dichromate Plated Wing Nuts (Inch) . . .	377
Zinc Dichromate Plated, Self-Locking Nuts — Plastic Insert (Inch / Hex Head / Coarse Thread (UNC) / Non-Hardened)	372
Zinc Dichromate Plated, Self-Locking Nuts — Plastic Insert (Inch / Hex Head / Fine Thread (UNF) / Non-Hardened)	372

O

Oil Dyes	53
---------------------------	----

Oils

Axle and Brake Oil Additive	416
Cat Diesel Engine Oil (DEO™)	404-406
Cat Final Drive and Axle Oil (FDAO™)	412
Cat Final Drive and Axle Oil Synthetic (FDAO Syn™)	413
Cat Gear Oil (GO)	415
Cat Hydraulic Oil (HYDO™)	414
Cat Multipurpose Tractor Oil (MTO)	411
Cat Natural Gas Engine Oil (NGEO™)	408
Cat Synthetic Diesel Engine Oil (DEO SYN™)	407
Cat Transmission and Drive Train Oil (TDTO™)	409-410
Cat Transmission and Drive Train Oil (TDTO-TMS™)	411
Synthetic Gear Oil (GO)	416
Orange Hand Cleaner	435

P

Paint

Black Muffler Paint	57,60
High Gloss	57, 60

Paint (continued)

Medium Gloss	57, 60
Miscellaneous Aerosol Products	58, 60-61
Paint and Primer Thinner	59, 61
Paint and Primer Thinner/Retarder	59, 61
Urethane Paint	58, 60
Yellow Primer	59, 61

Penetrating Oil	51
----------------------------------	----

Pins

Cotter Pins (Inch / Zinc Plated Steel)	391
Drawbar and Clevis Pins — Type I	390
Drawbar and Clevis Pins — Type II	390
Locking Pins (Inch / Steel)	390
Spring Pins — Roll Pin (Inch)	389

Pre-Cleaner Caps/Hoods	7
---	---

Pre-Cleaner Plastic Bowls	7
--	---

Pre-Cleaners	7
-------------------------------	---

Pressure Switches	37
------------------------------------	----

Profiler / Road Reclaimer

Blocks / Holders	324
Cutter Bits	324
Soil Stabilizer Tools	324
Specialty Tools	324

R

RTV Silicone (Black) General Purpose Sealant	50
---	----

RTV Silicone (Blue) General Purpose Sealant	49
--	----

RTV Silicone (Clear) General Purpose Sealant	49
---	----

RTV Silicone (Red) High Temperature Sealant	49
--	----

RTV Silicone (White) General Purpose Sealant (Non-Corrosive)	50
Radiator Repair	47
Radios	434
Rain Traps and Rain Caps	18
Remanufactured Products for Earthmoving Equipment	439-443
Remanufactured Products for Engines	445-446
Remanufactured Products for Paving Products	444
Rivets	
Rivets — Blind (Inch)	388
Rivets — Button Head Solid Shank (Inch) ...	387
Rivets — Flat Head Countersunk Shank (Inch)	386
Rod Ends	
Spherical Rod End (Inch)	394
Spherical Rod End (Metric)	394
Yoke-Type Rod End (Inch)	392
Yoke-Type Rod End (Metric)	392
Yoke-Type Rod End — Forged (Metric)	393
Yoke-Type Rod End — Jump Sizes (Metric) .	393
Router Bits	
Heavy Duty Router Bits	333
Quick Change Router Bits	333
Standard Router Bits	333
Rust Preventative	53

S

Screws

Machine Screws — Flat Head (Inch) (Coarse Thread)	383
Machine Screws — Pan Head (Inch)	382
Machine Screws — Round Head (Inch)	382

Screws (continued)

Set Screws — Cup Point (Inch) (Coarse Thread UNC)	383
Set Screws — Square Head (Inch)	384

Sealant For Liquid Filled Rims On Wheel Loaders

Sealant Repair Kit	51
--------------------------	----

Seals

Backup Rings	483-486
O-Ring Materials	480-482
O-Ring Measuring Cone	479
O-Ring Seal Kits	479
O-Rings	448-478

Segments - Loader

Half-Arrow Bolt-On Segments	291-295
Heavy Duty Bolt-On Segments	291-295
Standard Bolt-On Segments	291-295

Service Meters

Electronic Service Meters	427-428
Self-Powered Service Meters	428

Shanks - Ripper/Scarifier

Shank Protectors and Pin / Retainers	327
Shank Repair / Conversion Parts	327
Shanks	329

Sidebar Protectors	300
---------------------------------	-----

Sidecutters

Blade Type 1 Sidecutter	272-275
One Piece Sidecutter	272-275
Combination Blade Sidecutter	272-275
Heavy Duty Sidecutter	272-275
Strike-Off Sidecutter	272-275
Tooth Type Sidecutter	272-275

Index

Snap Rings

Snap Rings — External (Inch) 397

Snap Rings — Internal (Inch) 396

Sole Plates

Compactor Sole Plates 249

Spark Plug Firing Indicator 44

Spray Adhesive 46

Springs

Springs — Compression 399-400

Springs — Extension 401

Starting/Charging Analyzer Group 28

Studs — Taper Lock (Inch) 384

Sure-Seal Electrical Connector Kit 41

T

Thread Lubricant 55

Tips - Backhoe Loader

Bolt-On Unitooth Tip 218

Diagonal Retention System Tips 219

Front Bucket Tip Chart 220

Heavy Duty Abrasion Tip 219

Heavy Duty Long Tip 219

Long Tip 218

Penetration Tip 218

Rear Bucket Tip Chart 220

Sharp Center Tip 218

Short Tip 218

Twin Sharp Tip 219

Utility Tip 218

Wide Tip 218

Tips - Compactor

Landfill Compactor Tip / Blades 249

Tips - Excavator

Heavy Duty Abrasion Tip 270

Heavy Duty Long Life Tip 270

Heavy Duty Long Tip 270

J Family Identification 271

Long Sharp Tip 270

Long Tip 269

Penetration Long Life Tip 269

Penetration Plus Tip 270

Penetration Tip 269

Sharp Corner Tip / Sharp Center Tip 270

Short Tip 269

Tip Chart 271

Twin Sharp Tip 270

Utility Tip 269

Wide Tip 269

Tips - Large Ripper/Scarifier

ARM Ripper Tips 326

Centerline Ripper Tips 326

Penetration Ripper Tips 326

Tips - Loader

Bolt-On Unitooth Tip Chart 303

Bolt-On Unitooth Tips 303

Heavy Duty Abrasion Tip 301-302

Heavy Duty Long Life Tip 301-302

Heavy Duty Long Tip 301-302

Heavy Duty Penetration Tip 302

Long Tip 301-302

Penetration Tip 301-302

Tips - Loader (continued)

Short Tip	301-302
Utility Tip	301-302

Tips - Scraper

Bolt-On Adapter Tips	335
Integrated Tooth Cutting Edge Tips	334

Tips - Small Ripper/Scarifier

Centerline Ripper Tips	328
Penetration Ripper Tips	328

Toolmaker's Ink/Layout Blue	54
------------------------------------	----

Turbine Pre-Cleaners	8-13
-----------------------------	------

Turn Signal Flasher	429
----------------------------	-----

V

V-Belts

Cog Type	490-493
Non-Cog Type	489
V-Belt Maintenance Tips	488
V-Belt Sizing Guide	488

V.C.I. Oil	54
-------------------	----

Voltage Tester	43
-----------------------	----

W

Washers

Lock Washers — External Tooth (Inch)	380
Lock Washers — Split Spring (Inch)	380
Phosphate and Oil Coated Washers (Inch / Flat / Hardened)	378
Phosphate and Oil Coated Washers (Metric / Flat / Hardened)	381
SAE Washers (Inch / Flat)	379
USS Washers (Inch / Flat)	379

Washers (continued)

Zinc Dichromate Plated Washers (Inch / Flat / Hardened)	378
Zinc Dichromate Plated Washers (Metric / Flat / Hardened)	381

Water Temperature Thermostat	68
-------------------------------------	----

Wear Bars - Bulldozer

Bulldozer Wear Bars	239
Bulldozer Plates	239-243

Wear Plates - Compactor

Compactor Reinforcing Wear Plates	252
-----------------------------------	-----

Wear Plates - Loader

Base Edge Wear Plates	296, 298-299
Heavy Duty Base Edge Wear Plates	296, 298-299
Heavy Duty Rear Wear Plates	297-299
Rear Wear Plates	296, 298-299
Weld-On Rear Wear Plates	297-299
Weld-On Side Wear Plates	297-299

Wheel Assemblies

Landfill Compactor Wheel Assemblies	250
-------------------------------------	-----

Windshield Wiper Blades	431
--------------------------------	-----

Windshield Wiper Groups	431
--------------------------------	-----

Wire Protector	40
-----------------------	----

Woodruff Keys	395
----------------------	-----

IF YOU NEED PARTS, YOU NEED GENUINE CAT PARTS.

HERE'S WHY:

Genuine Caterpillar parts are built to exacting specifications and with the highest quality to deliver the best productivity and lowest cost per hour.



Genuine Caterpillar parts are designed to work with your equipment systems to perform better and last longer in even the most demanding working conditions.



Genuine Caterpillar parts are available when you need them, either in stock or just hours away through the Cat parts network.

Genuine Caterpillar Parts from your One Safe Source.

