

DSE5110
AUTOSTART CONTROL MODULE
OPERATING MANUAL

TABLE OF CONTENTS

	Page	Section
1 INTRODUCTION	5	
2 IDENTIFICATION OF “ORIGINAL” 5110 AND “NEW” 5110.....	6	
3 CLARIFICATION OF NOTATION USED WITHIN THIS PUBLICATION.	7	
4 OPERATION	8	
4.1 AUTOMATIC MODE OF OPERATION.....	9	
4.2 MANUAL OPERATION.....	10	
5 PROTECTIONS.....	11	
5.1 WARNINGS.....	12	
5.2 SHUTDOWNS	13	
6 DESCRIPTION OF CONTROLS	15	
6.1 TYPICAL LCD DISPLAY SCREENS.....	16	
6.2 LCD DISPLAY AREAS	17	
6.3 VIEWING THE INSTRUMENTS.....	18	
6.4 INDICATORS	19	
6.5 CONTROLS.....	19	
7 POWER UP LCD DISPLAY	20	
8 EVENT LOG	21	
8.1 ENTERING EVENT LOG VIEWER	21	
8.2 EVENT LOG EXAMPLES	21	
9 FRONT PANEL CONFIGURATION	22	
9.1 ENTERING CONFIGURATION MODE.....	22	
9.2 EDITING AN ANALOGUE VALUE	23	
9.3 EDITING A ‘LIST’ VALUE	23	
9.4 TIMERS & ANALOGUE SETTINGS.....	24	
9.5 LIST ITEM SETTINGS	25	
9.6 CONFIGURABLE OUTPUTS	26	
9.7 LCD INDICATORS.....	28	
9.8 CONFIGURABLE INPUTS	30	
10 INSTALLATION INSTRUCTIONS.....	31	
10.1 PANEL CUT-OUT	31	
10.2 COOLING.....	31	
10.3 UNIT DIMENSIONS	31	
10.4 FRONT PANEL LAYOUT.....	32	
10.5 REAR PANEL LAYOUT	32	
11 ELECTRICAL CONNECTIONS.....	33	
11.1 CONNECTION DETAILS.....	33	
11.1.1 PLUG “A” 8 WAY	33	
11.1.2 PLUG “B” 11 WAY	33	
11.1.3 PLUG “F” 4 WAY	33	
11.1.4 PLUG “G” 5 WAY	34	
11.1.5 PLUG “H” 4 WAY	34	
11.2 CONNECTOR FUNCTION DETAILS.....	35	
11.2.1 PLUG “A” 8 WAY	35	
11.2.2 PLUG “B” 11 WAY	35	
11.2.3 PLUG “F” 4 WAY	36	
11.2.4 PLUG “G” 5 WAY	36	
11.2.5 PLUG “H” 4 WAY	36	
11.2.6 PURCHASING ADDITIONAL CONNECTOR PLUGS FROM DSE.....	36	

12	SPECIFICATION	37
13	COMMISSIONING	38
13.1.1	PRE-COMMISSIONING	38
14	TYPICAL WIRING DIAGRAM	39
15	FAULT FINDING.....	39
16	FACTORY DEFAULT SETTINGS	41
17	ICONS AND LCD IDENTIFICATION	42
17.1	PUSH BUTTONS.....	42
17.2	STATUS / MEASUREMENT UNITS.....	42
17.3	ALARM INDICATIONS.....	42
18	APPENDIX.....	43
18.1	ALTERNATIVE WIRING TOPOLOGIES.....	43
18.1.1	1 PHASE, 2 WIRE	43
18.1.2	3 PHASE, 3 WIRE	43
18.1.3	2 PHASE, 3 WIRE	44
18.2	SENDER WIRING RECOMMENDATIONS	45
18.2.1	EARTH RETURN SENDERS	45
18.2.2	INSULATED RETURN SENDERS	45
18.3	CHOOSING THE CORRECT C.T.S	46
18.4	INPUT EXPANSION	47
18.5	STANDBY GENERATING SET?.....	47
18.6	FULLY INTEGRATED AUTO MAINS FAILURE.....	47
18.7	FRONT PANEL CONFIGURATION (ORIGINAL 5110).....	48
18.8	FRONT PANEL CONFIGURATION MK2 5110 V3	51

1 INTRODUCTION

The **DSE 5110** autostart module has been designed to allow the OEM to meet increasing demand within the industry. It has been primarily designed to allow the user to start and stop the generator. The user also has the facility to view all the system operating parameters via the LCD display.

The **DSE 5110** module monitors the engine, indicating the operational status and fault conditions automatically shutting down the engine and giving a true first up fault condition of an engine failure by a flashing COMMON ALARM LED. Exact failure mode information is indicated by the LCD display on the front panel.

The powerful Microprocessor contained within the module allows for a range of complex features to be incorporated as standard:

- *Graphical Icon based LCD display (excluding the need for translations and languages).*
- *Engine parameter monitoring and instrumentation.*
- *Generator Voltage, Frequency & Current instrumentation.*
- *Fully configurable inputs for use as alarms or a range of different functions.*
- *Extensive range of output functions using built in relay outputs.*
- *'Front panel' configuration of operating parameters.*
- *PC configurable using 5xxx configuration software for Windows™ and P810 interface module.*

The module is housed in a robust plastic case for front panel mounting. Connections to the module are via locking plug and sockets.

2 IDENTIFICATION OF “ORIGINAL” 5110 AND “NEW” 5110

▲NOTE:- In April 2005, the 5110 controller was updated to include PC configuration. At this time, a few minor changes to the front panel configuration were also made. This manual covers both the “original” and the “new” 5110 controller (V2 onwards).
The “new” 5110 (V2 onwards) module is identified easily by the PRESENCE of the P810 module configuration software on the rear of the module and the PRESENCE of the LOAD and GENERATOR mimic on the fascia label. (see below)
The “original” 5110 module is identified easily by the LACK of the P810 module configuration socket on the rear of the module and the LACK of the LOAD and GENERATOR mimic on the fascia label. (see below)

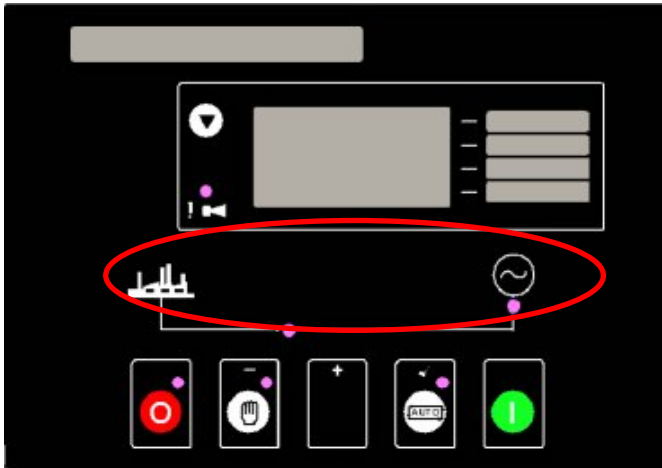

FASCIA OF *NEW* 5110

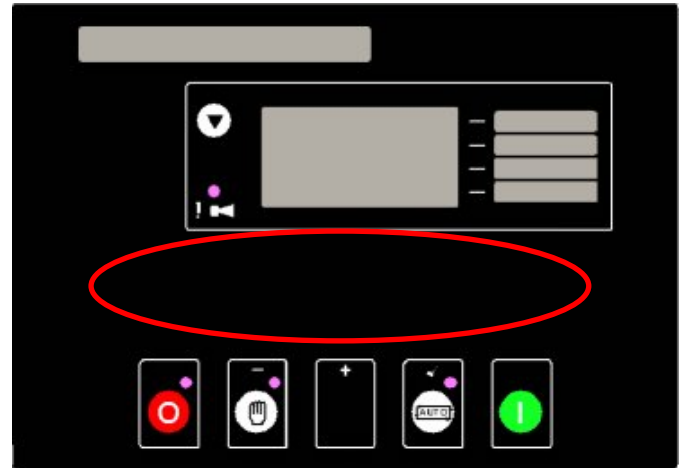

FASCIA OF *ORIGINAL* 5110









REAR OF *NEW* 5110



REAR OF *ORIGINAL* 5110

3 CLARIFICATION OF NOTATION USED WITHIN THIS PUBLICATION.

 NOTE:	Highlights an essential element of a procedure to ensure correctness.
 CAUTION!	Indicates a procedure or practice which, if not strictly observed, could result in damage or destruction of equipment.
 WARNING!	Indicates a procedure or practice, which could result in injury to personnel or loss of life if not followed correctly.
	Deep Sea Electronics Plc owns the copyright to this manual, which cannot be copied, reproduced or disclosed to a third party without prior written permission.
	Compliant with BS EN 60950 Low Voltage Directive Compliant with BS EN 50081-2 EMC Directive Compliant with BS EN 50082-2 EMC Directive
	Year 2000 Compliant

4 OPERATION

The following description details the sequences followed by a module containing the standard 'factory configuration'. Always refer to your configuration source for the exact sequences and timers observed by any particular module in the field.



4.1 AUTOMATIC MODE OF OPERATION

This mode is activated by pressing the  pushbutton. An LED indicator beside the button confirms this action.

When a **Remote Start** signal is applied to the remote start input, the following sequence is initiated:-

The **Remote Start Active** indicator illuminates (if configured).

To allow for false signals the Start Delay timer is initiated. After this delay, if the pre-heat output option is selected then the pre-heat timer is initiated, and the corresponding auxiliary output (if configured) will energise.

NOTE:- If the Remote Start signal is removed during the Start Delay timer, the unit will return to a stand-by state.

After the above delays the **Fuel Solenoid** is energised, then one second later, the **Starter Motor** is engaged.

The engine is cranked for a pre-set time period. If the engine fails to fire during this cranking attempt then the starter motor is disengaged for the pre-set rest period. Should this sequence continue beyond the set number of attempts (fixed at 3), the start sequence will be terminated and

Fail to Start  fault will be displayed accompanied by a flashing shutdown  symbol.

When the engine fires, the starter motor is disengaged and locked out at a pre-set frequency from the Alternator output. Alternatively a Magnetic Pickup mounted on the flywheel housing can be used for speed detection (This is selected using the front panel editor).

After the starter motor has disengaged, the **Safety On** timer is activated, allowing Oil Pressure, High Engine Temperature, Under-speed, Charge Fail and any delayed Auxiliary fault inputs to stabilise without triggering the fault.

Once the engine is running, the **Warm Up** timer, if selected is initiated, allowing the engine to stabilise before accepting the load.

If an auxiliary output has been selected to give a **load transfer** signal, this would then activate.

NOTE:-A load transfer will not be initiated until the Oil Pressure has risen. Thus preventing excessive wear on the engine.

NOTE:- If the remote start input is removed before the warming timer expires, the set will shut down after the warming timer.

On removal of the **Remote Start** signal, the **Stop** delay timer is initiated, once it has timed out, the **load Transfer** signal is de-energised, removing the load. The **Cooling** timer is then initiated, allowing the engine a cooling down period off load before shutting down. Once the **Cooling** timer expires the **Fuel Solenoid** is de-energised, bringing the generator to a stop.

Should the **Remote Start** signal be re-activated during the cooling down period, the set will return on load.

4.2 MANUAL OPERATION

To initiate a start sequence in **MANUAL**, press the  pushbutton. When the controller is in the manual mode (indicated by an LED indicator beside the button), pressing the **START (I)** button will initiate the start sequence.

 **NOTE:- There is no Start Delay in this mode of operation.**

 **NOTE:- When in manual mode, the remote start input cannot be used to begin the start sequence.**

If the **pre-heat** output option is selected this timer is then initiated, and the auxiliary output selected is energised.

After the above delay the **Fuel Solenoid** is energised, then the **Starter Motor** is engaged.

The engine is cranked for a pre-set time period. If the engine fails to fire during this cranking attempt then the starter motor is disengaged for the pre-set rest period. Should this sequence continue beyond the set number of attempts (fixed at 3), the start sequence will be terminated and

Fail to Start  fault will be displayed accompanied by a flashing shutdown  indicator.

When the engine fires, the starter motor is disengaged and locked out at a pre-set frequency from the Alternator output. Alternatively a Magnetic Pickup mounted on the flywheel housing can be used for speed detection (This is selected using the front panel editor).

After the starter motor has disengaged, the **Safety On** timer is activated, allowing Oil Pressure, High Engine Temperature, Under-speed, Charge Fail and any delayed Auxiliary fault inputs to stabilise without triggering the fault.

Once the engine is running, the **Warm Up** timer, if selected is initiated, allowing the engine to stabilise before it can be loaded.

The generator will run off load, unless a **Remote Start** signal is applied, and if **Load Transfer** has been selected as a control source, the appropriate auxiliary output selected will activate.



If the **Remote Start** signal is removed, the generator will continue to run **On** load until the **Auto** mode is selected. The **Remote Stop Delay Timer** will time out, the load is then disconnected. The generator will then run **off** load allowing the engine a **cooling** down period.

 **NOTE:- Removing the remote start input when the set is on load will not cause the generator to be taken off load.**

Selecting **STOP (O)** de-energises the **FUEL SOLENOID**, bringing the generator to a stop.

5 PROTECTIONS

The module will indicate that an alarm has occurred in several ways;

The "Common alarm" LED will illuminate (Warning = Red steady, Shutdown = Red Flashing)	
If appropriate, the LCD display or LED indicators will display the appropriate alarm icon i.e. for battery charging failure :	

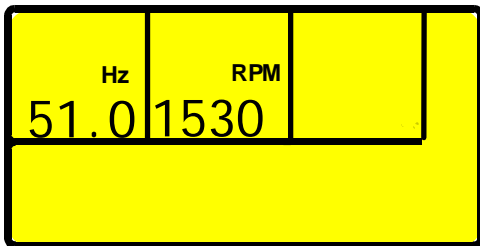

If no alarms are present the LCD will extinguish any alarm icons.

In the event of a warning alarm the LCD will display the appropriate icon. If a shutdown then occurs the module will display the appropriate icon. The original warning alarm icon will remain displayed.
Example:-

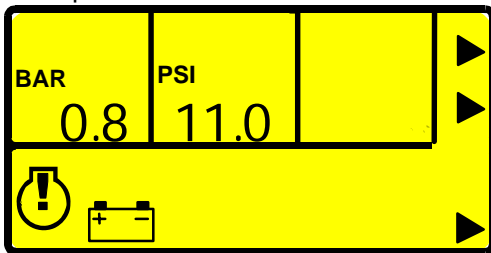

Charge alternator warning (all symbols steady)

Followed by....

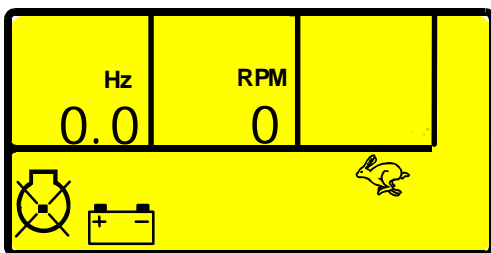

Charge alternator warning indicator still present, common alarm indicator has changed to a shutdown symbol and is now flashing.
Also present is the flashing overspeed LED.

Overspeed and Shutdown alarm Icons are displayed flashing. The original warning will remain displayed as long as the triggering conditions remain. Any subsequent warnings or shutdowns that occur will be displayed steady, therefore only the first-up shutdown will appear flashing.

5.1 WARNINGS

Warnings are non-critical alarm conditions and do not affect the operation of the generator system, they serve to draw the operators attention to an undesirable condition.

In the event of a warning alarm the LCD will display:-



BATTERY CHARGE FAILURE, if the module does not detect a voltage from the warning light terminal on the auxiliary charge alternator the  icon will illuminate.

FAIL TO STOP, If the module detects the engine is still running when the 'Fail to stop timer' expires, then the module will display:-



▲ NOTE:- 'Fail to Stop' could indicate a faulty oil pressure sender - If engine is at rest check oil sender wiring and configuration.

AUXILIARY INPUTS, if an auxiliary input has been configured as a warning the appropriate LCD segment will be displayed:-



5.2 SHUTDOWNS

Shutdowns are latching and stop the Generator. The alarm must be cleared, and the fault removed to reset the module.

In the event of a shutdown alarm the LCD will display: -



(flashing).

The appropriate icon will also be displayed flashing

NOTE:- The alarm condition must be rectified before a reset will take place. If the alarm condition remains it will not be possible to reset the unit (The exception to this is the Low Oil Pressure alarm and similar 'delayed alarms', as the oil pressure will be low with the engine at rest). Any subsequent warnings or shutdowns that occur will be displayed steady, therefore only the first-up shutdown will appear flashing.

FAIL TO START, if the engine does not fire after the pre-set number of attempts has been made a shutdown will be initiated.

The  icon will illuminate.

EMERGENCY STOP, removal of the **Positive DC** Supply from the Emergency Stop input initiates the following sequence, firstly it will initiate a controlled shutdown of the Generator and prevent any attempt to restart the Generator until the Emergency Stop push-button has been reset. Secondly it removes the **Positive DC** supply from both the Fuel Solenoid and Starter Solenoid.

The  icon will illuminate.

NOTE:- The Emergency Stop Positive signal must be present otherwise the unit will shutdown.

LOW OIL PRESSURE, if the module detects that the engine oil pressure has fallen below the low oil pressure trip setting level after the **Safety On** timer has expired, a shutdown will occur.

The  icon will illuminate.

HIGH ENGINE TEMPERATURE if the module detects that the engine coolant temperature has exceeded the high engine temperature trip setting level after the **Safety On** timer has expired, a shutdown will occur.

The  icon will illuminate.

OVERSPEED / OVERFREQUENCY, if the engine speed exceeds the pre-set trip a shutdown is initiated.

The  icon will illuminate.

Overspeed is not delayed, it is an **immediate shutdown**.

NOTE:- During the start-up sequence the overspeed trip logic will allow for a small amount of overshoot. This temporarily raises the overspeed trip point during the safety delay timer. This is used to prevent nuisance tripping on start-up.

UNDERSPEED / UNDERFREQUENCY, if the engine speed falls below the pre-set trip after the Safety On timer has expired, a shutdown is initiated.

The  icon will illuminate.

OIL PRESSURE SENDER OPEN CIRCUIT, if the module detects a loss of signal from the oil pressure sender (open circuit) a shutdown is initiated. The LCD will indicate:-

 (Steady) (And '-----' on the engine oil pressure instrument). Sender failure is not delayed; it is an **immediate shutdown**.

AUXILIARY INPUTS, if an auxiliary input has been configured as a shutdown the appropriate LCD segment will be displayed: -



LOSS OF SPEED SIGNAL, if the speed sensing signal is lost during cranking, a shutdown is initiated. The  icon will illuminate (Steady). As engine speed cannot be determined, the entire "fail to stop" timer is observed before the alarm can be reset and the engine restarted.

 **NOTE:- This will only occur if the controller is configured for magnetic pickup and the speed sensing signal is lost during cranking or during the safety on timer. If the signal is lost during normal operation the Generator will shutdown with an Under-speed alarm.**



6 DESCRIPTION OF CONTROLS

The following section details the function and meaning of the various controls on the module.

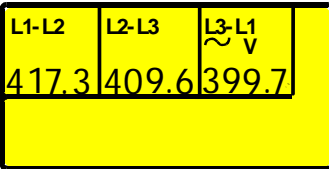

FIG2

6.1 TYPICAL LCD DISPLAY SCREENS

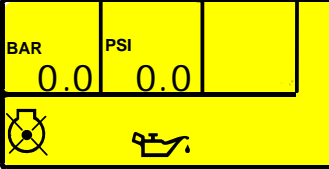
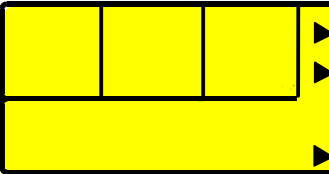
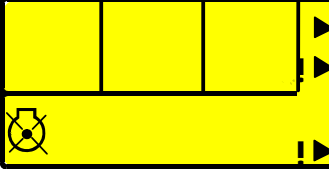
<p>INSTRUMENTS</p> 	<p>The LCD displays the various engine parameters such as 'ENGINE SPEED', 'OIL PRESSURE', 'HOURS RUN', etc. Each instrument is displayed with the appropriate units of measure. In this example, the values being displayed are Generator phase to phase AC  voltages V.</p>
<p>ALARM ICONS</p> 	<p>The LCD also displays the exact nature of any alarm condition that may have occurred such as LOW OIL PRESSURE using appropriate icons. This allows very specific alarm conditions to be brought to the operators' attention. Refer to the 'Protections' section of this manual for details of the alarms.</p>
<p>USER DEFINED INDICATIONS</p> 	<p>The LCD displays the user-defined indications when configured and active. The icons will illuminate and point to the appropriate text insert label. These indications can be used to indicate internal states (i.e. Engine Running, Safety On, etc).</p>
<p>USER DEFINED ALARMS</p> 	<p>The LCD displays the user-defined alarms when configured and active. The icons will illuminate and point to the appropriate text insert label. These alarms can be used to indicate the operation of external alarms (i.e. 'Low Fuel Level', 'Low Coolant level' etc) or to indicate internal alarms (i.e. Fail to Stop, MPU fault, etc).</p>

6.2 LCD DISPLAY AREAS

Instrument Values

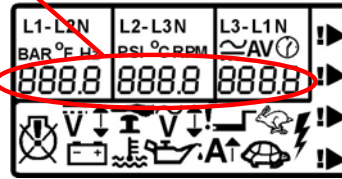

Display Information & Units of Measure

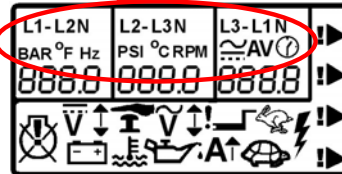

Alarm Icons

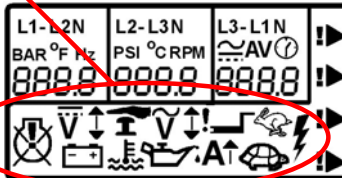

User Definable Alarms/Indicators

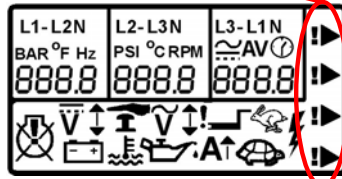

▲ NOTE:- The Engine Hours Run counter will only display the accumulated hours to the nearest 12 Minutes (0.2Hr). The accumulated time will be recorded in HH: MM however.

▲ CAUTION!:- If the DC supply to the module is interrupted the hours run counter will not remember any 'un-displayed' minutes accumulated since the last 12 Minute display update.
i.e.
10 Hours 38 Minutes accumulated before DC supply is removed...
(10.6 Hours displayed)
would become ...10 Hours 36Minutes on restoration of DC supply.
(10.6 Hours still displayed)
This will only occur in the event of a total DC supply break and will NOT occur if the module is simply switched to the Stop/Reset position.





6.3 VIEWING THE INSTRUMENTS

It is possible to manually scroll to display the different instruments by repeatedly operating the scroll button. Once selected the instrument will remain on the LCD display until the user selects a different instrument or after a period of inactivity the module will revert to the initial display (Hz/RPM).

Instrument Page Order:-

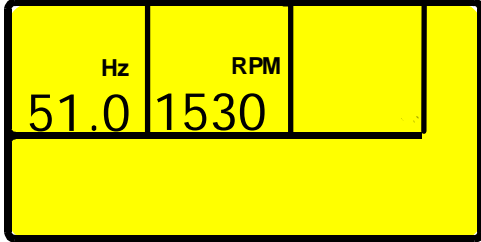
- *Frequency / RPM*
- *AC Voltage Line-Neutral*
- *AC Voltage Line-Line*
- *AC Line Current*
- *Oil Pressure*
- *Coolant temperature*
- *Engine Hours Run*
- *DC Battery Voltage*

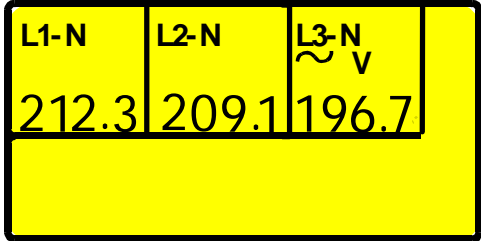

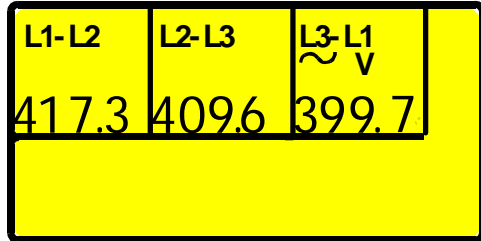
Manually Selecting an Instrument

Initial display (Hz/RPM)		
Pressing the DOWN button the LCD will then show (Generator L-N voltages)		
Pressing the DOWN button the LCD will then show (Generator L-L voltages)		



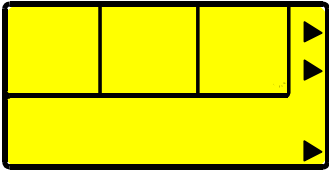

Pressing the  button again will scroll through each individual instrument eventually returning to the original instrument displayed.

NOTE:-Once selected the instrument will remain on the LCD display until the user selects a different instrument or after a period of inactivity the module will revert to the initial display.

6.4 INDICATORS

<p>COMMON ALARM LCD indicators These indicate when an alarm condition is present. The Alarm icons or LED's will detail the exact nature of the alarm.</p>	 (warning) or  (shutdown)
<p>USER CONFIGURABLE LCD INDICATORS These LCD's can be configured by the user to indicate any on of the different functions based around the following:-</p> <ul style="list-style-type: none"> • WARNINGS and SHUTDOWNS - Specific indication of a particular warning or shutdown condition, backed up by LCD indication (!)- <i>Such as Low Oil Pressure Shutdown, Low Coolant level, etc.</i> • STATUS INDICATIONS - Indication of specific functions or sequences derived from the modules operating state - <i>Such as Safety On, Pre-heating, Generator Available, etc.</i> 	

6.5 CONTROLS

<p>STOP/RESET This button places the module into its Stop/reset mode. This will clear any alarm conditions for which the triggering criteria have been removed. If the engine is running and this position is selected, the module will automatically instruct the changeover device to unload the generator ('Close generator' becomes inactive (if used)). The fuel supply will be removed and engine will be brought to a standstill. Should a remote start signal be present while operating in this mode, a remote start will <u>not</u> occur.</p>	
<p>MANUAL This mode is used to allow manual control of the generator functions. Once in Manual mode the module will respond to the start (I) button and start the engine and run off load. If the engine is running off-load in the Manual mode and a remote start signal becomes present, the module will automatically instruct the changeover device to place the generator on load ('Close generator' becomes active (if used)). Should the remote start signal then be removed the generator will remain on load until either the 'STOP/RESET' or 'AUTO' positions is selected.</p>	
<p>AUTO This button places the module into its 'Automatic' mode. This mode allows the module to control the function of the generator automatically. The module will monitor the remote start input and once a start condition is signalled the set will be automatically started and placed on load ('Close generator' becomes active (if used)). If the starting signal is removed the module will automatically transfer the load from the generator and shut the set down observing the stop delay timer and cooling timer as necessary. The module will then await the next start event. <i>For further details please see the more detailed description of 'Auto Operation' earlier in this manual.</i></p>	
<p>START This button is only active in MANUAL  mode. Pressing this button in manual mode will start the engine and run off load. If the engine is running off-load in the Manual mode and a remote start signal becomes present, the module will automatically instruct the changeover device to place the generator on load ('Close generator' becomes active (if used)). Should the remote start signal then be removed the generator will remain on load until either the 'STOP/RESET' or 'AUTO' positions is selected.</p>	

7 POWER UP LCD DISPLAY

In April 2005, the 5110 controller was updated to include PC configuration. At this time, a few minor changes to the front panel configuration were also made.

This section details the power up display of the “new” 5110 module.

When DC power is first applied to the 5110 controller, a short LCD test is performed that illuminates all LCD segments.

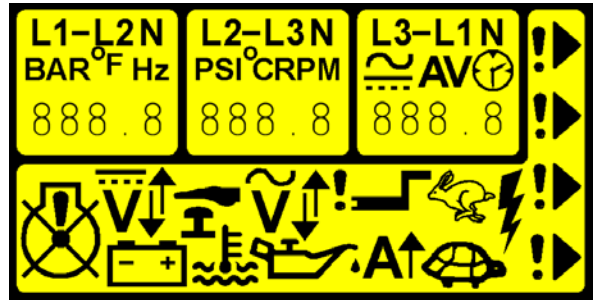

After this, the module’s software revision number is shown briefly. For example, this display is showing software revision 1.00

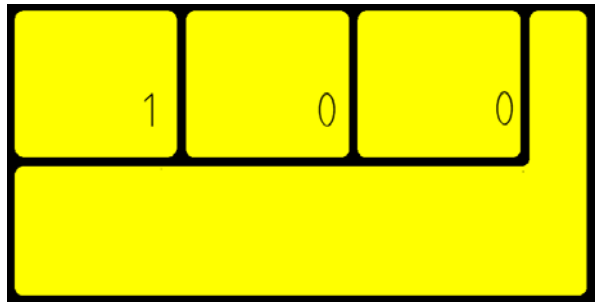

NOTE:- The “*original*” 5110 controller does not have a power up LCD check or version number display. The “*original*” controller is identified easily. See the section entitled *Identification of “original” 5110 and “new” 5110 (V2 onwards)* elsewhere in this manual.

8 EVENT LOG

Model 5110 features an integral 20 item event log. This log contains the last 20 shutdown alarms registered by the controller.

8.1 ENTERING EVENT LOG VIEWER

NOTE:- Entering the event log will place the module into STOP mode, shutting down the engine if it is already running. Additionally, all module LEDs are extinguished.

Press and hold the **STOP**  button for five seconds to enter the event log viewer

The latest shutdown event is displayed.

Pressing the scroll  button will cycle through the events, returning to the first one, once the end of the list is reached.

Press the **STOP**  button at any time to exit the event log viewer.

If no shutdown event is logged, the display will indicate "---" in place of the hours counter.

Timer symbol to indicate event log mode

Event number

Indication of shutdown alarm logged (eg. emergency stop)

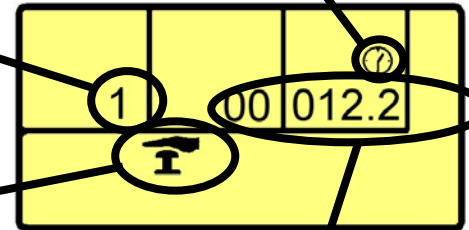

Engine hours Counter at the time of the logged shutdown alarm (eg 12.2 hrs)

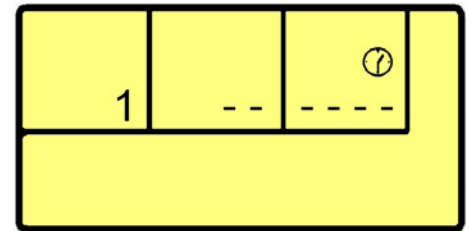

8.2 EVENT LOG EXAMPLES

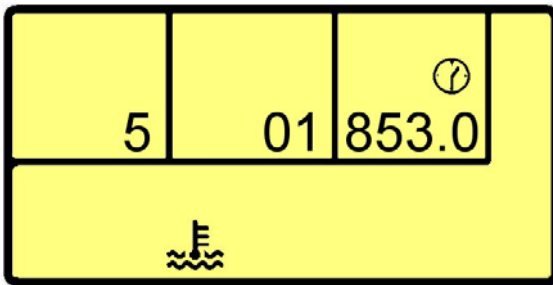

5th most recent event - High engine temperature shutdown when engine hours counter was 1853 hrs

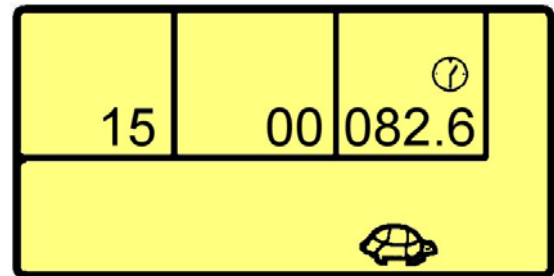

15th most recent event - Underfrequency shutdown when engine hours counter was 82.6 hrs

9 FRONT PANEL CONFIGURATION

In April 2005, the 5110 controller was updated to include PC configuration. At this time, a few minor changes to the front panel configuration were also made.

This section details the configuration editor of the “new” 5110 module. For details of the configuration editor for the “original” 5110, see the Appendix section of this manual.

To identify the “original” and “new” controllers, See the section entitled **Identification of “original” 5110 and “new” 5110** elsewhere in this manual.

▲ NOTE:- PC Configuration is possible on the “new” 5110 controller (V2 onwards) in addition to the Front Panel Configuration. PC configuration offers additional settings such as oil pressure / sender curve editing and the ability to load / save configuration files to disk.

9.1 ENTERING CONFIGURATION MODE

▲ NOTE:- Configuration mode can ONLY be entered when the module is in the STOP mode and the engine is at rest.

Press the **DOWN** and **STOP** buttons to enter configuration mode.



The first configurable parameter is displayed. In this example, the Start delay timer (parameter 0) is currently set to 5s.

Parameter
(Start delay)

Current value
(5 seconds)

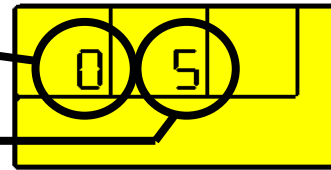

9.2 EDITING AN ANALOGUE VALUE

Enter the front panel configuration editor as described above. Press the ✓ button to enter adjust mode.

When in adjust mode (indicated by the flashing ↑↓ icons in the module display), pressing the + or – buttons will change the selected parameter to the desired value. Press the ✓ button to ‘save’ the value. The ↑↓ icons will stop flashing to confirm that it has been saved.

To select the next parameter to edit, press the + button. Continuing to press the + / – buttons will cycle through the adjustable parameters in the order shown in the following lists.

Timers display in seconds up to 59 seconds, then in minutes upto the timer’s maximum value.

For instance, the parameter being displayed in this example is the cooling timer (parameter 7). It’s current value is 2.5mins (2mins 30secs).

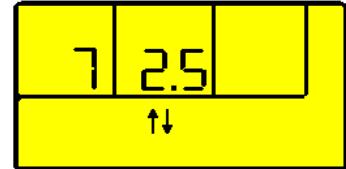

9.3 EDITING A ‘LIST’ VALUE

Some configuration parameters have a list of options to select from. These include input and output settings.

This example shows the setting for LCD indicator 1 (parameter 29). It’s current setting is 3 (‘Load Transfer from the list shown overleaf).

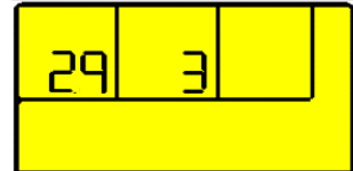

⚠NOTE:- When in adjust mode (indicated by the flashing ↑↓ icons in the module display), pressing the 0 (stop mode) button will cancel any changes made to the current parameter, reverting to the last ‘saved’ value. This also exits adjust mode.

⚠NOTE:- To exit the front panel configuration editor at any time press the STOP  button. Ensure you save any changes you have made by pressing the ✓ button first if necessary.

9.4 TIMERS & ANALOGUE SETTINGS

Parameter	Type	Default	Max
0 - Start delay	Timer	5s	60s
1 - Preheat	Timer	0s	60s
2 - Crank attempt	Timer	10s	60s
3 - Crank rest	Timer	10s	60s
4 - Safety delay	Timer	8s	60s
5 - Warming up	Timer	0s	60m
6 - Return delay	Timer	30s	60m
7 - Cooling run	Timer	60s	60m
8 - E.T.S. solenoid hold	Timer	0s	60s
9 - Sensor fail delay	Timer	2s	5s
10 - Fail to Stop Delay	Timer	60s	60s
11 - Low Oil Pressure	Trip	15PSI	150PSI
12 - High Temperature	Trip	95°C	150°C
13 - Under Speed	Trip	1250RPM	3600RPM
14 - Over Speed	Trip	1750RPM	5000RPM
15 - Underfrequency	Trip	40Hz	60Hz
16 - Overfrequency	Trip	57Hz	72Hz
17 - Charge Alt Failure	Warning	8V DC	25V DC
18 - Flywheel teeth	Value	0	300
19 - CT Primary	Value	500A	6000A

▲NOTE:- Setting a timer to zero (0) will disable it. Timer settings increment from 0 to 60s in steps of 1s and from 1 minute to the maximum value in steps of 30 seconds (0.5 minutes) (where applicable)

▲NOTE:- Setting Flywheel teeth to zero (0) will disable magnetic pickup speed sensing. In this instance, engine speed is derived from the alternator output frequency.

▲NOTE:- CT values increment from 10-100 in steps of 10A, and from 100 to 6000A in steps of 50A. CT secondary must be 5A.

9.5 LIST ITEM SETTINGS

Factory default settings are in ***bold italicised*** text.

Parameter	Selections
20 - Alternator poles	0,2, 4,6,8
21 - Oil pressure input	0 - Not used
	1 - Digital, close for low pressure
	2 - Digital, open for low pressure
	3 - VDO 0-5bar
	4 - VDO 0-10bar
	5 - Datcon 5bar
	6 - Datcon 10bar
	7 - Datcon 7bar
	8 - Murphy 7bar
	9 - User configured
22 - Coolant temp input	0 - Not used
	1 - Digital, close for high temperature
	2 - Digital, open for high temperature
	3 - VDO 40°C to 120°C
	4 - Datcon High
	5 - Datcon Low
	6 - Murphy
	7 - Cummins
	8 - PT100
	9 - User configured

Parameter	Selections
23 - Fast loading enabled	0 - No
	1 - Yes
24 - AC system	0 - 3 phases 4 wires
	1 - 1 phase 2 wire
	2 - 3 phases 3 wires
	3 - 2 phases 3 wires
25 - Oil pressure display units	0 - Bar/PSI
	1 - kPa

9.6 CONFIGURABLE OUTPUTS

Factory default settings are in ***bold italicised*** text.

Parameter	Selection
26 – Output 1	0 - Unused
	<i>1 - Preheat mode 0</i>
	2 - Air flap
	3 – Close Generator
	4 - Energise to stop
	5 - Engine running
	6 - Shutdown alarm
	7 - System in auto
	8 - Auxiliary input 1 active
	9 - Auxiliary input 2 active
	10 - Auxiliary input 3 active
	11 - Auxiliary input 4 active
	12 - Auxiliary input 5 active
	13 - Preheat mode 1
	14 - Preheat mode 2
	15 - Preheat mode 3
	16 - Warning alarm
17 - Common alarm	
27 – Output 2	0 - Unused
	1 - Preheat mode 0
	2 - Air flap
	3 - Load transfer
	4 - Energise to stop
	5 - Engine running
	6 - Shutdown alarm
	7 - System in auto
	8 - Auxiliary input 1 active
	9 - Auxiliary input 2 active
	10 - Auxiliary input 3 active
	11 - Auxiliary input 4 active
	12 - Auxiliary input 5 active
	13 - Preheat mode 1
	14 - Preheat mode 2
	15 - Preheat mode 3
	16 - Warning alarm
17 - Common alarm	

CONFIGURABLE OUTPUTS (CONTINUED)

Factory default settings are in ***bold italicised*** text.

Parameter	Selection
28 – Output 3	0 - Unused
	1 - Preheat mode 0
	2 - Air flap
	<i>3 - Load transfer</i>
	4 - Energise to stop
	5 - Engine running
	6 - Shutdown alarm
	7 - System in auto
	8 - Auxiliary input 1 active
	9 - Auxiliary input 2 active
	10 - Auxiliary input 3 active
	11 - Auxiliary input 4 active
	12 - Auxiliary input 5 active
	13 - Preheat mode 1
	14 - Preheat mode 2
	15 - Preheat mode 3
	16 - Warning alarm
17 - Common alarm	

▲NOTE:- The 'preheat modes' selectable for configurable outputs and LCD indicators perform the following actions :

- Preheat mode 0 - Preheat during preheat timer, ceasing at end of preheat timer.
- Preheat mode 1 - Preheat during preheat timer and continue until engine stops cranking.
- Preheat mode 2 - Preheat during preheat timer and continue until the safety delay timer has expired.
- Preheat mode 3 - Preheat during preheat timer and continue until the warming timer has expired.

In addition, in all preheat modes, preheat takes place during the crank rest timer between crank cycles.

9.7 LCD INDICATORS

Factory default settings are in *bold italicised* text.

Parameter	Selection
29 - LCD 1	0 - Unused
	1 - Preheat mode 0
	2 - Air flap
	3 - Load transfer
	4 - Energise to stop
	5 - Engine running
	6 - Shutdown alarm
	7 - System in auto
	8 - Auxiliary input 1 active
	9 - Auxiliary input 2 active
	10 - Auxiliary input 3 active
	11 - Auxiliary input 4 active
	12 - Auxiliary input 5 active
	13 - Preheat mode 1
	14 - Preheat mode 2
	15 - Preheat mode 3
	16 - Warning alarm
17 - Common alarm	
30 - LCD 2	0 - Unused
	1 - Preheat mode 0
	2 - Air flap
	3 - Load transfer
	4 - Energise to stop
	5 - Engine running
	6 - Shutdown alarm
	7 - System in auto
	8 - Auxiliary input 1 active
	9 - Auxiliary input 2 active
	10 - Auxiliary input 3 active
	11 - Auxiliary input 4 active
	12 - Auxiliary input 5 active
	13 - Preheat mode 1
	14 - Preheat mode 2
	15 - Preheat mode 3
	16 - Warning alarm
17 - Common alarm	

LCD INDICATORS (CONTINUED)

Factory default settings are in ***bold italicised*** text.

Parameter	Selection
31 - LCD 3	0 - Unused
	1 - Preheat mode 0
	2 - Air flap
	3 - Load transfer
	4 - Energise to stop
	5 - Engine running
	6 - Shutdown alarm
	7 - System in auto
	8 - Auxiliary input 1 active
	9 - Auxiliary input 2 active
	10 - Auxiliary input 3 active
	<i>11 - Auxiliary input 4 active</i>
	12 - Auxiliary input 5 active
	13 - Preheat mode 1
	14 - Preheat mode 2
	15 - Preheat mode 3
	16 - Warning alarm
17 - Common alarm	
32 - LCD 4	0 - Unused
	1 - Preheat mode 0
	2 - Air flap
	3 - Load transfer
	4 - Energise to stop
	5 - Engine running
	6 - Shutdown alarm
	7 - System in auto
	8 - Auxiliary input 1 active
	9 - Auxiliary input 2 active
	10 - Auxiliary input 3 active
	11 - Auxiliary input 4 active
	<i>12 - Auxiliary input 5 active</i>
	13 - Preheat mode 1
	14 - Preheat mode 2
	15 - Preheat mode 3
	16 - Warning alarm
17 - Common alarm	

 NOTE:- The 'preheat modes' selectable for configurable outputs and LCD indicators perform the following actions :

- Preheat mode 0 - Preheat during preheat timer, ceasing at end of preheat timer.
- Preheat mode 1 - Preheat during preheat timer and continue until engine stops cranking.
- Preheat mode 2 - Preheat during preheat timer and continue until the safety delay timer has expired.
- Preheat mode 3 - Preheat during preheat timer and continue until the warming timer has expired.

In addition, in all preheat modes, preheat takes place during the crank rest timer between crank cycles.

9.8 CONFIGURABLE INPUTS

Factory default settings are in ***bold italicised*** text.

Parameter	Selection
33 – Input 1	0 - Delayed, Warning, close to activate
	1 - Delayed, Warning, open to activate
	2 - Immediate, Warning, close to activate
	3 - Immediate, Warning, open to activate
	4 - Delayed, Shutdown, close to activate
	5 - Delayed, Shutdown, open to activate
	6 - Immediate, Shutdown, close to activate
	7 - Immediate, Shutdown, open to activate
	8 - Remote Start, close to activate
	9 - Remote Start, open to activate
34 – Input 2	0 - Delayed, Warning, close to activate
	1 - Delayed, Warning, open to activate
	2 - Immediate, Warning, close to activate
	3 - Immediate, Warning, open to activate
	4 - Delayed, Shutdown, close to activate
	5 - Delayed, Shutdown, open to activate
	6 - Immediate, Shutdown, close to activate
	7 - Immediate, Shutdown, open to activate
	8 - Electrical trip, close to activate
	9 - Electrical trip, open to activate
35 – Input 3	0 - Warning, Delayed, close to activate
	1 - Warning, Delayed, open to activate
	2 - Warning, Immediate, close to activate
	3 - Warning, Immediate, open to activate
	4 - Shutdown, Delayed, close to activate
	5 - Shutdown, Delayed, open to activate
	6 - Shutdown, Immediate, close to activate
	7 - Immediate, Shutdown, open to activate
	8 - Lamp test, close to activate
	9 - Lamp test, open to activate
36 – Input 4	0 - Delayed, Warning, close to activate
	1 - Delayed, Warning, open to activate
	2 - Immediate, Warning, close to activate
	3 - Immediate, Warning, open to activate
	4 - Delayed, Shutdown, close to activate
	5 - Delayed, Shutdown, open to activate
	6 - Immediate, Shutdown, close to activate
	7 - Immediate, Shutdown, open to activate
37 - Input 5	0 - Delayed, Warning, close to activate
	1 - Delayed, Warning, open to activate
	2 - Immediate, Warning, close to activate
	3 - Immediate, Warning, open to activate
	4 - Delayed, Shutdown, close to activate
	5 - Delayed, Shutdown, open to activate
	6 - Immediate, Shutdown, close to activate
	7 - Immediate, Shutdown, open to activate
	8 - Oil pressure switch, Shutdown, open for low oil pressure
	9 - Oil pressure switch, Shutdown, close for low oil pressure

10 INSTALLATION INSTRUCTIONS

The model DSE 5110 Module has been designed for front panel mounting. Fixing is by 4 clips for easy assembly.

10.1 PANEL CUT-OUT

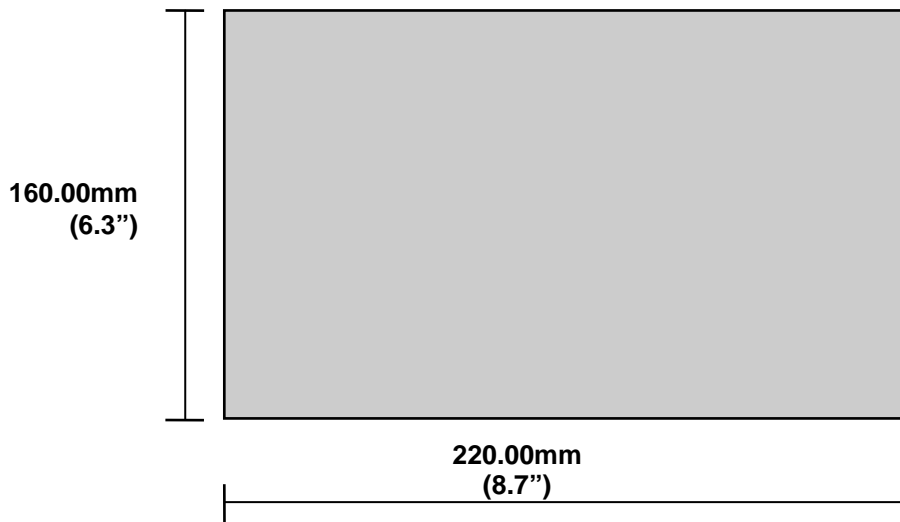

FIG 3

Maximum panel thickness – 8mm (0.3").

In conditions of excessive vibration the module should be mounted on suitable anti-vibration mountings.

10.2 COOLING

The module has been designed to operate over a wide temperature range **-30 to +70° C**. Allowances should be made for the temperature rise within the control panel enclosure. Care should be taken **NOT** to mount possible heat sources near the module unless adequate ventilation is provided. The relative humidity inside the control panel enclosure should not exceed **95%**.

10.3 UNIT DIMENSIONS

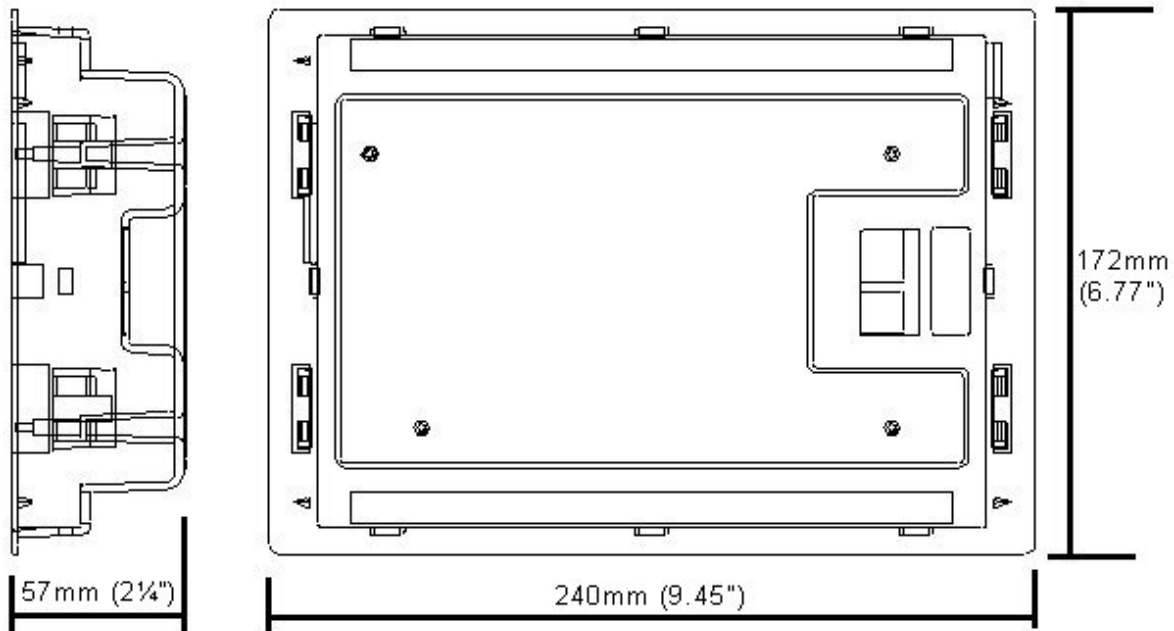

Panel cutout 220mm x 160mm (8.7" x 6.3")

10.4 FRONT PANEL LAYOUT



10.5 REAR PANEL LAYOUT

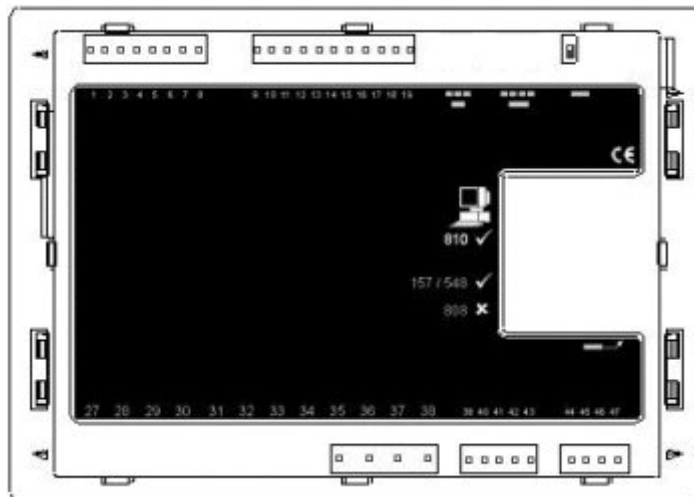

11 ELECTRICAL CONNECTIONS

Connections to the Module are via plug and sockets.

11.1 CONNECTION DETAILS

The following describes the connections and recommended cable sizes to the 7 plugs and sockets on the rear of the Module. See rear panel layout **FIG 6**.

11.1.1 PLUG "A" 8 WAY

PIN No	DESCRIPTION	CABLE SIZE	NOTES
1	DC Plant Supply Input (Negative)	2.5mm ² (13 AWG)	
2	DC Plant Supply Input (Positive)	2.5mm ² (13 AWG)	(Recommended Maximum Fuse 21A)
3	Emergency Stop Input	2.5mm (13 AWG)	Plant Supply Positive. Also supplies fuel & start outputs. (Recommended Maximum Fuse 32A)
4	Fuel relay Output	2.5mm ² (13 AWG)	Plant Supply Positive from pin 3. 16 Amp rated.
5	Start relay Output	2.5mm ² (13 AWG)	Plant Supply Positive from pin 3. 16 Amp rated.
6	Auxiliary Output relay 1	1.0mm ² (18 AWG)	Plant Supply Positive. 5 Amp rated.
7	Auxiliary Output relay 2	1.0mm (18 AWG)	Plant Supply Positive. 5 Amp rated.
8	Auxiliary Output relay 3	1.0mm (18 AWG)	Plant Supply Positive. 5 Amp rated.

11.1.2 PLUG "B" 11 WAY

PIN No	DESCRIPTION	CABLE SIZE	NOTES
9	Charge fail / excite	2.5mm ² (13 AWG)	Do not connect to ground (battery Negative)
10	Auxiliary input 1	0.5mm ² (20 AWG)	Switch to Negative
11	Auxiliary input 2	0.5mm ² (20 AWG)	Switch to Negative
12	Auxiliary input 3	0.5mm ² (20 AWG)	Switch to Negative
13	Auxiliary input 4	0.5mm ² (20 AWG)	Switch to Negative
14	Auxiliary input 5	0.5mm ² (20 AWG)	Switch to Negative
15	Not connected	-	
16	Functional Earth	2.5mm ² (13 AWG)	Connect to a good clean earth point
17	Magnetic pickup Positive	0.5mm ² (20 AWG)	Connect to Magnetic Pickup device
18	Magnetic pickup Negative	0.5mm ² (20 AWG)	Connect to Magnetic Pickup device
19	Not connected	-	

 **NOTE:-** Ensure magnetic pickup screen is connected to ground at one end only.

 **NOTE:-** Terminal numbers 20-34 are not fitted to the 5110 controller

11.1.3 PLUG "F" 4 WAY

PIN No	DESCRIPTION	CABLE SIZE	NOTES
35	Generator L1 voltage monitoring input	1.0mm ² (18 AWG)	Connect to generator L1 output (AC) (Recommend 2A fuse)
36	Generator L2 voltage monitoring input	1.0mm ² (18 AWG)	Connect to generator L2 output (AC) (Recommend 2A fuse)
37	Generator L3 voltage monitoring input	1.0mm ² (18 AWG)	Connect to generator L3 output (AC) (Recommend 2A fuse)
38	Generator Neutral input	1.0mm ² (18 AWG)	Connect to generator Neutral terminal (AC)

11.1.4 PLUG "G" 5 WAY

PIN No	DESCRIPTION	CABLE SIZE	NOTES
39	CT Secondary for L1	2.5mm ² (13 AWG)	Connect to secondary of L1 monitoring CT
40	CT Secondary for L2	2.5mm ² (13 AWG)	Connect to secondary of L2 monitoring CT
41	CT Secondary for L3	2.5mm ² (13 AWG)	Connect to secondary of L3 monitoring CT
42	CT secondary common	2.5mm ² (13 AWG)	Connect to secondary of all monitoring CT's
43	Not connected	-	

11.1.5 PLUG "H" 4 WAY

PIN No	DESCRIPTION	CABLE SIZE	NOTES
44	Oil Pressure Input	0.5mm ² (20 AWG)	Connect to Oil pressure sender
45	Coolant Temperature Input	0.5mm ² (20 AWG)	Connect to Coolant Temperature sender
46	Not connected	-	
47	Sender Common Return	0.5mm ² (20 AWG)	Return feed for senders*.

 **NOTE*:-** If using single terminal senders refer to connection diagram. If using earth return type senders connect return terminals to pin 47 and also connect pin 47 to earth. This is detailed in the Appendix section entitled "Sender wiring recommendations" elsewhere in this manual.

11.2 CONNECTOR FUNCTION DETAILS

The following describes the functions of the 3 connectors on the rear of the module. See rear panel layout FIG 5.

11.2.1 PLUG "A" 8 WAY

PIN No	DESCRIPTION
1	DC Supply Negative. System DC negative input. (Battery Negative).
2	DC Supply Positive. System DC positive input. (Battery Positive).
3	Emergency Stop input. Internally linked to Starter and Fuel outputs. If this input is not connected to positive the module will be locked out, and if the engine is running it will shutdown immediately. The Positive Supply is also removed from Starter and Fuel outputs, therefore only a single pole Emergency Shutdown button is required.
4	Fuel Relay output. Plant Supply Positive from pin 3. Used to control the fuel solenoid or engine fuel control system.
5	Starter Relay output. Plant Supply Positive from pin 3. Used to control the Starter Motor.
6	Auxiliary Relay output 1. Plant Supply Positive. Configurable output, see section entitled "Front Panel Configuration" elsewhere in this manual for options available.
7	Auxiliary Relay output 2. Plant Supply Positive. Configurable output, see section entitled "Front Panel Configuration" elsewhere in this manual for options available.
8	Auxiliary Relay output 3. Plant Supply Positive. Configurable output, see section entitled "Front Panel Configuration" elsewhere in this manual for options available.

11.2.2 PLUG "B" 11 WAY

PIN No	DESCRIPTION
9	Charge Fail input / Excitation output. Supplies excitation to the Plant Battery Charging Alternator, also input for the Charge Fail detection circuitry.
10	Auxiliary input 1. This is a negative switched configurable input, see Calibration Manual for options available. It is possible to configure the input to be a normally closed signal or a normally open signal.
11	Auxiliary input 2. This is a negative switched configurable input, see Calibration Manual for options available. It is possible to configure the input to be a normally closed signal or a normally open signal.
12	Auxiliary input 3. This is a negative switched configurable input, see section entitled "Front Panel Configuration" elsewhere in this manual for options available. It is possible to configure the input to be a normally closed signal or a normally open signal.
13	Auxiliary input 4. This is a negative switched configurable input, see section entitled "Front Panel Configuration" elsewhere in this manual for options available. It is possible to configure the input to be a normally closed signal or a normally open signal.
14	Auxiliary input 5. This is a negative switched configurable input, see section entitled "Front Panel Configuration" elsewhere in this manual for options available. It is possible to configure the input to be a normally closed signal or a normally open signal.
15	Not connected
16	Functional Earth - Ensure connection to a good clean earth point.
17	Magnetic Input Positive. An AC signal from the magnetic pickup Positive for speed sensing.
18	Magnetic Input Negative. An AC signal from the magnetic pickup -ve for speed sensing.
19	Not connected

 **NOTE:-** Ensure magnetic pickup screen is connected to ground at one end only.

 **NOTE:-** Terminal numbers 20-34 are not fitted to the 5110 controller

11.2.3 PLUG "F" 4 WAY

PIN No	DESCRIPTION
35	Generator L1 sensing input. Connect to alternator L1 output.
36	Generator L2 sensing input. Connect to alternator L2 output. If using single phase only do not connect this terminal.
37	Generator L3 sensing input. Connect to alternator L3 output. If using single phase only do not connect this terminal.
38	Generator N sensing input. Connect to alternator N output.

11.2.4 PLUG "G" 5 WAY

PIN No	DESCRIPTION
39	Generator L1 current transformer connection.
40	Generator L2 current transformer connection. If single phase is used do not connect this pin.
41	Generator L3 current transformer connection. If single phase is used do not connect this pin.
42	Generator current transformer common connection and CT earth connection.
43	Not used. Do not connect to this terminal.

11.2.5 PLUG "H" 4 WAY

PIN No	DESCRIPTION
44	Oil Pressure sensing input. Connect to resistive type oil pressure sender. Refer to connection diagram for details.
45	Coolant Temperature sensing input. Connect to resistive type coolant temperature sender. Refer to connection diagram for details.
46	Not used. Do not connect to this terminal.
47	Sender Common connection. Return feed from sender units - refer to connection diagram for details.

11.2.6 PURCHASING ADDITIONAL CONNECTOR PLUGS FROM DSE

If you require additional plugs from DSE, please contact our Sales department using the part numbers below.

5110 Terminal	Connector	Plug description	DSE Part number
1-8	A	BL08 8way 5.08mm spacing connector plug	007-125
9-19	B	BL11 11way 5.08mm spacing connector plug	007-135
35-38	F	BL04 4way 10.16mm spacing connector plug	007-003
39-43	G	BL05 5way 5.08mm spacing connector plug	007-329
44-47	H	BL04 4way 5.08mm spacing connector plug	007-100

 **NOTE:- Connectors C, D & E are not fitted to the 5110 remote start module.**

12 SPECIFICATION

DC Supply	8.0 V to 35 V Continuous.
Cranking Dropouts	Able to survive 0 V for 50mS, providing supply was at least 10 V before dropout and supply recovers to 5V. <i>This is achieved without the need for internal batteries.</i>
Max. Operating Current (all inputs & outputs active except fuel / start)	320mA at 12V, 215mA at 24V
Max. Standby Current (all inputs & outputs active except fuel / start)	175mA at 12V, 95mA at 24V
Alternator Input Range Single phase 2 wire system 3Phase 4Wire System	15 V AC - 300 V AC (ph-N) (+20%) 15 V AC - 300 V AC (ph-N) (+20%)
Alternator Input Frequency	50Hz - 60 Hz at rated engine speed
Magnetic Input Range (if fitted)	+/- 0.5 V to 70 V Peak
Magnetic Input Frequency	10,000 Hz (max) at rated engine speed.
Start Relay Output	16 Amp DC at supply voltage.
Fuel Relay Output	16 Amp DC at supply voltage.
Auxiliary Relay Outputs	5 Amp DC at supply voltage.
Dimensions	240mm x 172mm x 57mm (9.5" x 6.8" x 2.3")
Panel cut-out	220mm x 160mm (8.7" x 6.3") Maximum panel thickness 8mm (0.3")
Charge Fail / Excitation Range	0 V to 35 V
Operating Temperature Range	-30 to +70°C
C.T. Burden	2.5VA (see note)
C.T. Secondary	5A
C.T. Class	Class 1 or better recommended
Electromagnetic Compatibility	BS EN 61000-6-2 EMC Generic Emission Standard (Industrial) BS EN 61000-6-4 EMC Generic Immunity Standard (Industrial)
Electrical Safety	BS EN 60950 Safety of I.T. equipment, including electrical business equipment.
Cold Temperature	BS EN 60068-2-1 to -30 °C
Hot Temperature	BS EN 60068-2-2 to +70°C
Humidity	BS60068-2-38 to 93% RH @ 40°C for 48 Hours
Vibration	BS EN60068-2-6 10 sweeps at 1 octave/minute in each of 3 major axes. 5Hz to 8Hz @ +/-7.5mm constant displacement 8Hz to 500Hz @ 2gn constant acceleration
Shock	BS EN 2011-2-1 3 Half sine shocks in each of 3 major axes 15gn amplitude, 11mS duration

NOTE:- Although the 5110's burden on the measurement C.T.'s is 2.5VA, the required C.T. rating will need to be higher depending upon the type and length of cabling used. For further details see the Appendix section entitled "Choosing the correct C.T.'s" elsewhere in this manual.

13 COMMISSIONING

13.1.1 PRE-COMMISSIONING

Before the system is started, it is recommended that the following checks are made:-

- 7.1. The unit is adequately cooled and all the wiring to the module is of a standard and rating compatible with the system.
- 7.2. The unit **DC** supply is fused and connected to the battery and that it is of the correct polarity.
- 7.3. The Emergency Stop input is wired to an external normally closed switch connected to **DC** positive.

NOTE:- If Emergency Stop feature is not required link this input to the DC Positive. The module will not operate unless either the Emergency Stop is fitted correctly OR Pin 3 is connected to DC positive (Positive)

- 7.4. To check the start cycle operation take appropriate measures to prevent the engine from starting (disable the operation of the fuel solenoid). After a visual inspection to ensure it is safe to proceed, connect the battery supply. Select "**MANUAL**" and press START (I) the unit start sequence will commence.
- 7.5. The starter will engage and operate for the pre-set crank period. After the starter motor has attempted to start the engine for the pre-set number of attempts the LCD will display its icon indicating; 'Failed to start' . Select the **STOP/RESET** position to reset the unit.
- 7.6. Restore the engine to operational status (reconnect the fuel solenoid), again select "**MANUAL**" and press START(I) this time the engine should start and the starter motor should disengage automatically. If not then check that the engine is fully operational (fuel available, etc.) and that the fuel solenoid is operating. The engine should now run up to operating speed. If not and an alarm is present, check the alarm condition for validity, then check input wiring. The engine should continue to run for an indefinite period. It will be possible at this time to view the engine and alternator parameters - refer to the 'Description of Controls' section of this manual.
- 7.7. Select "**AUTO**" on the front panel, the engine will run for the pre-set cooling down period, then stop. The generator should stay in the standby mode. If not check that there is not a signal present on the **Remote start** input.
- 7.8. Initiate an automatic start by supplying the remote start signal. The start sequence will commence and the engine will run up to operational speed. Once the generator is available a load transfer will take place, the Generator will accept the load. If not, check the wiring to the Generator Contactor Coil (*if used*). Check the Warning timer has timed out.
- 7.9. Remove the remote start signal, the return sequence will start. After the pre-set time period, the load will be removed from the generator. The generator will then run for the pre-set cooling down period, then shutdown into its standby mode.
- 7.10. If despite repeated checking of the connections between the **5110** and the customer's system, satisfactory operation cannot be achieved, then the customer is requested to contact the factory for further advice on:-

INTERNATIONAL TEL: +44 (0) 1723 890099

INTERNATIONAL FAX: +44 (0) 1723 893303

E-mail: Support@Deepseapl.com

Website : www.deepseapl.com

14 TYPICAL WIRING DIAGRAM

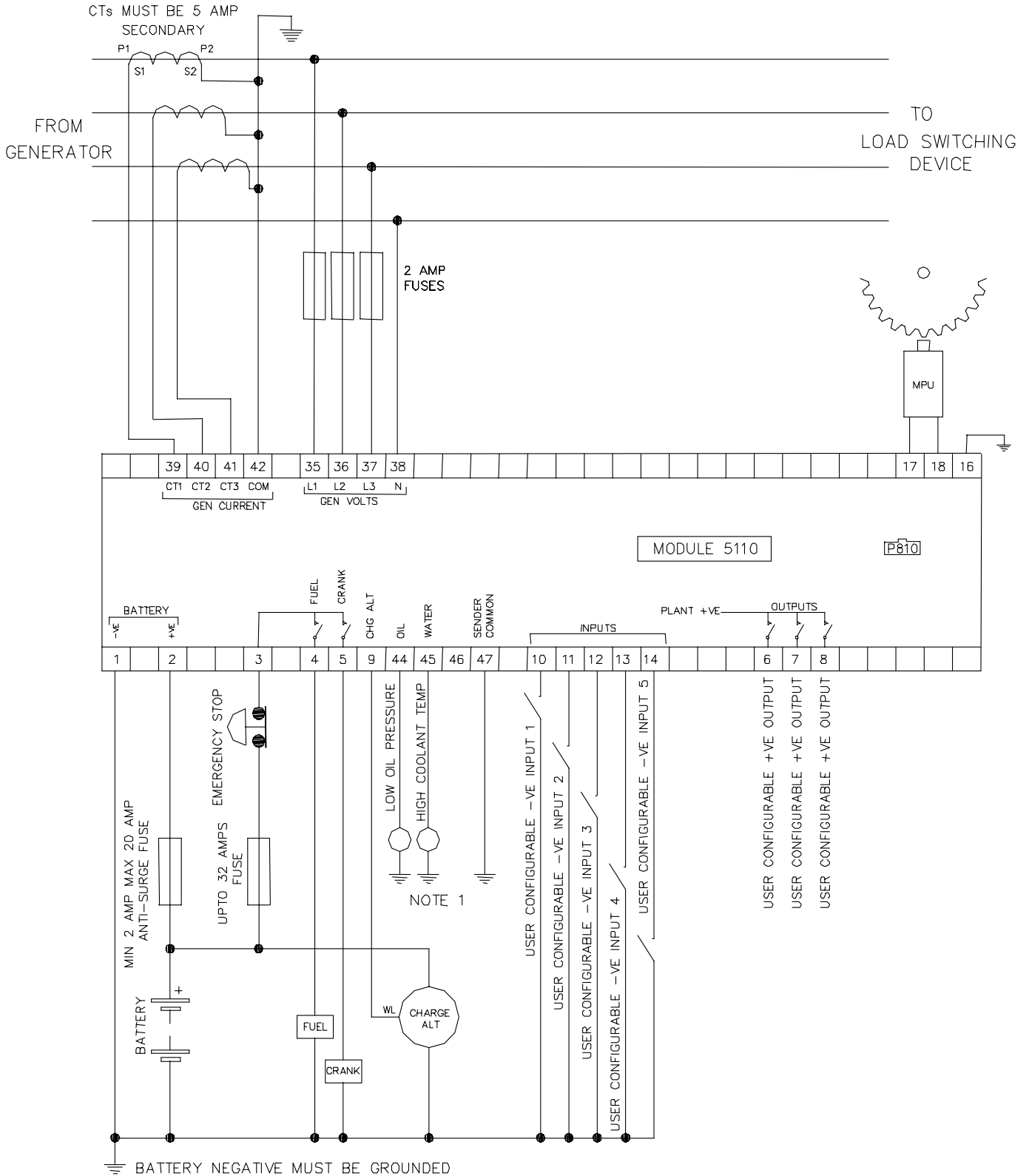

TERMINALS SUITABLE FOR 22-16 AWG (0.6mm - 1.3mm) FIELD WIRING

TIGHTENING TORQUE = 0.8Nm (7lb-in)

NOTE 1
THESE GROUND CONNECTIONS MUST BE ON THE ENGINE BLOCK, AND MUST BE TO THE SENDER BODIES.

THE GROUND WIRE TO TERMINAL 47 MUST NOT BE USED TO PROVIDE A GROUND CONNECTION TO ANY OTHER DEVICE

15 FAULT FINDING

SYMPTOM	POSSIBLE REMEDY
Unit is inoperative	Check the battery and wiring to the unit. Check the DC supply. Check the DC fuse.
Unit shuts down	Check DC supply voltage is not above 35 Volts or below 9 Volts Check the operating temperature is not above 70 °C. Check the DC fuse.
Unit locks out on Emergency Stop	If an Emergency Stop Switch is not fitted, ensure that a positive is connected to the Emergency Stop input. Check emergency stop switch is functioning correctly. Check Wiring is not open circuit.
Intermittent Magnetic Pick-up sensor fault	Ensure that Magnetic pick-up screen is only connected at one end, if connected at both ends, this enables the screen to act as an aerial and will pick up random voltages.
Low oil Pressure fault operates after engine has fired	Check engine oil pressure. Check oil pressure switch/sender and wiring. Check configured polarity (if applicable) is correct (i.e. Normally Open or Normally Closed) or that sender is compatible with the 5110 Module and is correctly configured.
High engine temperature fault operates after engine has fired.	Check engine temperature. Check switch/sender and wiring. Check configured polarity (if applicable) is correct (i.e. Normally Open or Normally Closed) or that sender is compatible with the 5110 Module.
Shutdown fault operates	Check relevant switch and wiring of fault indicated on LCD display. Check configuration of input.
Warning fault operates	Check relevant switch and wiring of fault indicated on LCD display. Check configuration of input.
Fail to Start is activated after pre-set number of attempts to start	Check wiring of fuel solenoid. Check fuel. Check battery supply. Check battery supply is present on the Fuel output of the module. Check the speed sensing signal is present on the 5110 inputs. Refer to engine manual.
Continuous starting of generator when in AUTO	Check that there is no signal present on the "Remote Start" input. Check configured polarity is correct.
Generator fails to start on receipt of Remote Start signal.	Check Start Delay timer has timed out. If remote start fault, check signal is on "Remote Start" input. Confirm input is configured to be used as "Remote Start".
Pre-heat inoperative	Check wiring to engine heater plugs. Check battery supply. Check battery supply is present on the Pre-heat output of module. Check pre-heat has been selected in your configuration.
Starter motor inoperative	Check wiring to starter solenoid. Check battery supply. Check battery supply is present on the Starter output of module. Ensure that the Emergency Stop input is at Positive.
Engine runs but generator will not take load	Check Warm up timer has timed out. Ensure generator load inhibit signal is not present on the module inputs.
Incorrect reading on Engine gauges	Check engine is operating correctly. Check sender and wiring paying particular attention to the wiring to terminal 47 (refer to appendix). Check that sender is compatible with the 5110 Module and is correctly configured.

 **NOTE:- The above fault finding is provided as a guide check-list only. As it is possible for the module to be configured to provide a wide range of different features always refer to the source of your module configuration if in doubt.**





16 FACTORY DEFAULT SETTINGS

Modules are shipped from the factory with parameters set to the following values. These can be user adjusted via the front panel configuration editor. For further details on adjustment via the front panel editor, see the section entitled "Front panel configuration" elsewhere within this manual.





Parameter	Default
0 - Start delay	5s
1 - Preheat	0s
2 - Crank attempt	10s
3 - Crank rest	10s
4 - Safety delay	8s
5 - Warming up	0s
6 - Return delay	30s
7 - Cooling run	60s
8 - E.T.S. solenoid hold	0s
9 -Sensor fail delay	2s
10 - Fail to Stop Delay	60s
11 - Low Oil Pressure	15PSI
12 - High Temperature	95°C
13 - Under Speed	1250RPM
14 - Over Speed	1750RPM
15 - Underfrequency	40Hz
16 - Overfrequency	57Hz
17 - Charge Alt Failure	8V DC
18 - Flywheel teeth	0 (magnetic pickup disabled)
19 - CT Primary	500A
20 - Alternator poles	4
21 - Oil Pressure transducer	3 - VDO 0-10bar
22 - Coolant temp transducer	2 - VDO 0-120°C
23 - Fast loading enabled	0 - No
24 - AC system	3 - 3 phase 4 wire
25 - Oil pressure display units	0 - Bar/PSI
26 - Output 1	1 - Preheat mode 0
27 - Output 2	17 - Common alarm
28 - Output 3	3 - Close generator
29 - LCD 1	9 - Auxiliary input 2 active
30 - LCD 2	10 - Auxiliary input 3 active
31 - LCD 3	11 - Auxiliary input 4 active
32 - LCD 4	12 - Auxiliary input 5 active
33 - Input 1	8 - Remote Start, close to activate
34 - Input 2	0 - Delayed, Warning, close to activate
35 - Input 3	2 - Warning, Immediate, close to activate
36 - Input 4	4 - Delayed, Shutdown, close to activate
37 - Input 5	6 - Immediate, Shutdown, close to activate

17 ICONS AND LCD IDENTIFICATION













17.1 PUSH BUTTONS

Display	Description	Display	Description	Display	Description
	Stop/Reset		Auto mode		Manual mode
	Start (when in manual mode)				Scroll

17.2 STATUS / MEASUREMENT UNITS

Display	Description	Display	Description	Display	Description
L1	Phase	L2	Phase	L3	Phase
L1- N	Phase - Neutral	L2- N	Phase - Neutral	L3- N	Phase -Neutral
L1-L2	Phase - Phase	L2- L3	Phase - Phase	L3- L1	Phase - Phase
BAR	Pressure	HPa	KPa Oil Pressure Units	PSI	Pressure
V	Voltage	°F	Temperature	Hz	Frequency
A	Amperes	°C	Temperature	RPM	Speed
	Hours Run		AC		Parameter being adjusted
			DC		

17.3 ALARM INDICATIONS

Display	Description	Display	Description	Display	Description
	Warning Alarm		Shutdown Alarm		Electrical Trip
			Low Oil Pressure		Over-speed
	Charge Fail		High Coolant Temperature		Under-speed
	Emergency Stop		Fail to start (Over-crank)		Auxiliary Indication
			Auxiliary Alarm (Warning or Shutdown)		

18 APPENDIX

18.1 ALTERNATIVE WIRING TOPOLOGIES

The 5110 series controllers can support different wiring topologies (AC systems) to suit the systems in use worldwide. The 'Typical connection diagram' details how to connect the module when used in a 3 phase, 4 wire system (3 phase star connected alternators). Changes to this typical wiring diagram for other AC systems are detailed below.

NOTE:- The factory default configuration for the 5110 module is for use with the 3 phase, 4 wire AC system. If another system is to be used, the controller must be reconfigured using the front panel editor detailed elsewhere within this manual.

18.1.1 1 PHASE, 2 WIRE

Single phase alternator with neutral conductor.

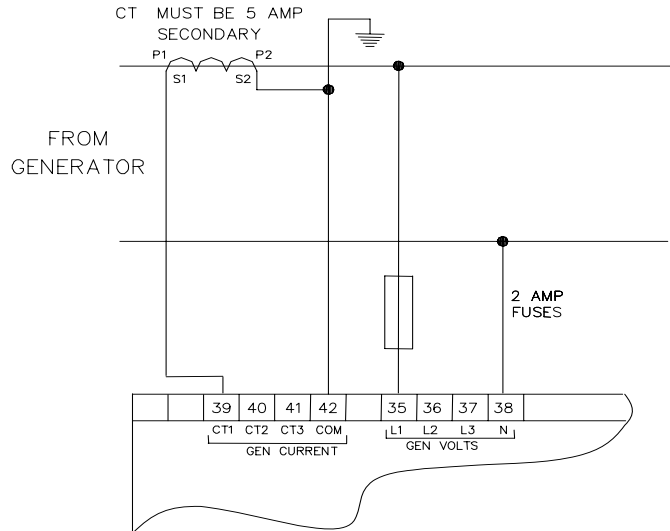

18.1.2 3 PHASE, 3 WIRE

Three phase alternator DELTA.

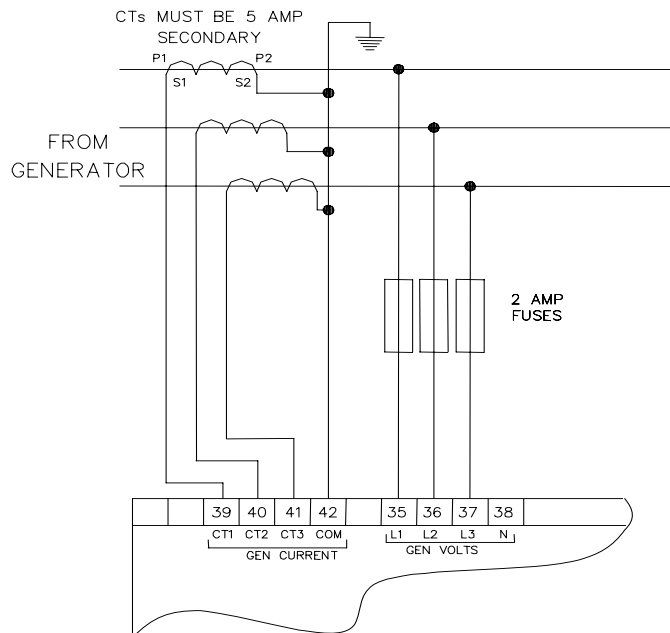

18.1.3 2 PHASE, 3 WIRE

Two measured phases with Neutral as a centre tap between the two live phases.

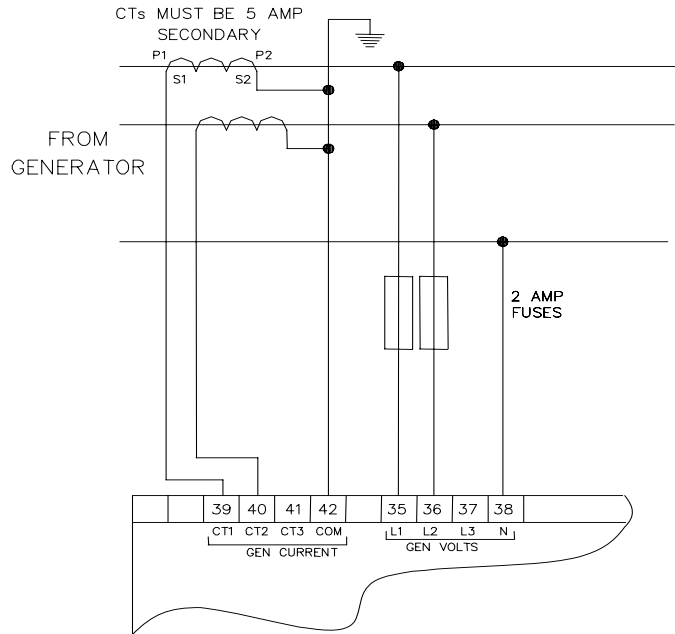

18.2 SENDER WIRING RECOMMENDATIONS

18.2.1 EARTH RETURN SENDERS

Connection Name	Terminal Number	
Oil pressure Sender	44	
Coolant temperature sender	45	
Sender common	47	

▲ NOTE:- . It is important that terminal 47 (sender common) is soundly connected to an earth point on the **ENGINE BLOCK**, not within the control panel, and must be a sound electrical connection to the sender bodies.

▲ NOTE:- . If you use PTFE insulating tape on the sender thread when using earth return senders, ensure you do not insulate the entire thread as this will prevent the sender body from being earthed via the engine block.

18.2.2 INSULATED RETURN SENDERS

Connection Name	Terminal Number	
Oil pressure Sender	44	
Coolant temperature sender	45	
Sender common	47	

▲ NOTE:- . It is important that terminal 47 (sender common) is soundly connected to an earth point on the **ENGINE BLOCK**, not within the control panel .

18.3 CHOOSING THE CORRECT C.T.S

The VA burden of the 5110 on the measurement CTs (Current transformers) is 2.5VA. However depending upon the type and length of cabling between the CTs and the modules, CTs with a greater VA rating than 2.5VA are required.

DETAILS

The distance between the CTs and the measuring module should be estimated and cross-referenced against the chart opposite to find the VA burden of the cable itself.

The star point (common) of the CTs MUST be connected to system ground (earth) as close as possible to the CTs. This minimises the length of cable used to connect the CTs to the DSE module.

Example.

If 1.5mm² cable is used and the distance from the CT to the measuring module is 20m, then the burden of the cable alone is approximately 7.5VA. As the burden of the DSE controller is 2.5VA, then a CT with a rating of at least 7.5+2.5V = 10VA must be used.

If 2.5mm² cable were used over the same distance of 20m, then the burden of the cable on the CT would be approximately 4VA. CT's required in this instance is at least 6.5VA (4+2.5).

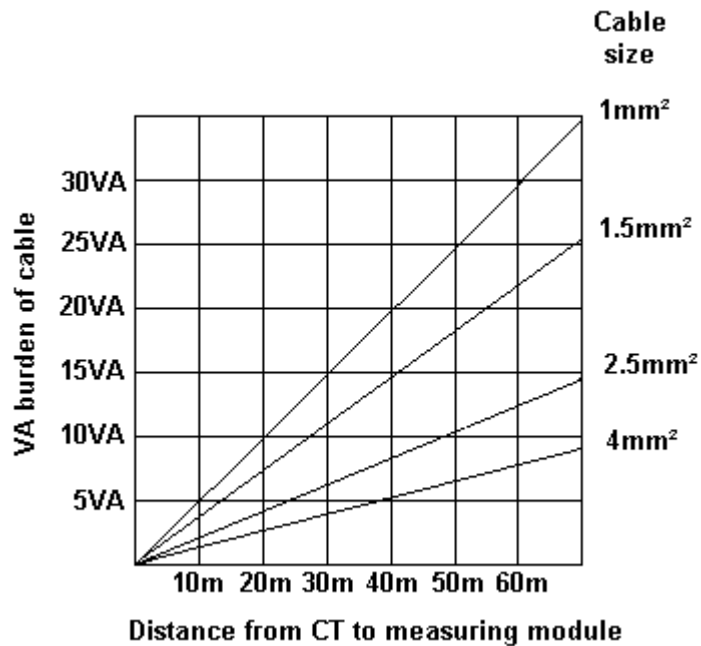

NOTE:- Details for 4mm² cable are shown for reference only. The connector on the DSE modules are only suitable for cables up to 2.5mm².

NOTE:- C.T.'s with 5A secondary windings must be used with the 5110 module. Ratios from 10A : 5A up to 6000A : 5A can be used.

As the C.T.'s are used purely for instrumentation purposes (not protection) within the 5110 module, protection class C.T.'s are not required. To match the specification of the 5110 module, it is recommended that C.T.'s of Class 0.5 be used to give the best possible measurement accuracy.

18.4 INPUT EXPANSION

It is possible to increase the number of monitored inputs available by utilising a DSE 54x Protection Expansion/Annunciator. Please refer to our Technical department for details.

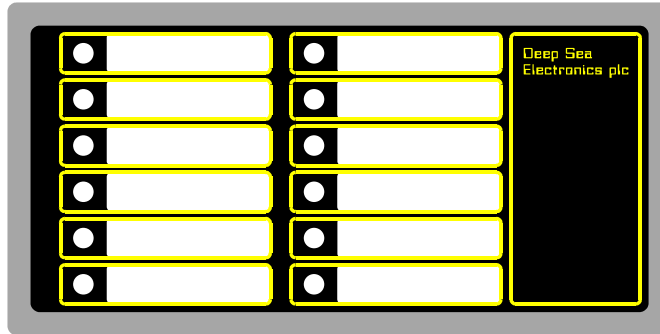

18.5 STANDBY GENERATING SET?

The 5110 needs to be given a remote start signal to initiate an engine start. This can be supplied by a Mains/Utility monitoring module to make the generating set start up automatically should the mains/utility supply fail. The 5110 module may be used in conjunction with DSE Automatic transfer switch controllers such as the model 500 (pictured below), 705 or 530. These not only monitor the mains and issue a start command to the 5110 they also provide control of the contactors or other changeover devices. Please refer to our Technical department for details.

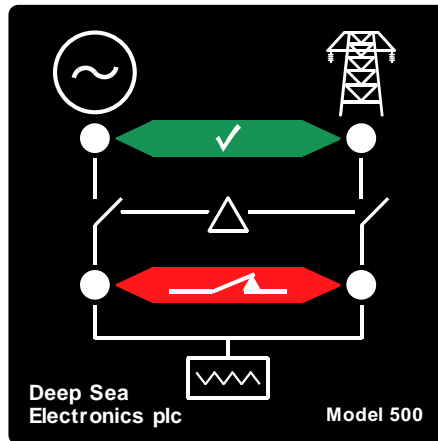

18.6 FULLY INTEGRATED AUTO MAINS FAILURE

The 5110 module can easily be replaced with a 5220 automatic mains failure controller. It has exactly the same mounting details and uses exactly the same rear connectors. Upgrading provides integral mains (utility) monitoring and changeover functions in the same controller. Please refer to our website for details (<http://www.deepseapl.com>)

18.7 FRONT PANEL CONFIGURATION (ORIGINAL 5110)

In April 2005, the 5110 controller was updated to include PC configuration. At this time, a few minor changes to the front panel configuration were also made.

This section details the configuration editor of the "Original" 5110 module. To identify the "original" and "new" controllers, See the section entitled *Identification of "original" 5110 and "new" 5110 from V2 onwards* elsewhere in this manual.

NOTE:- PC Configuration is not possible on the "original" 5110 controller. All options must be edited using the Front Panel Configuration Editor.

ACCESSING THE CONFIGURATION EDITOR

Operate the Configuration mode switch into the "configure" position. (This recessed switch is located on the rear of the module in the top right corner when viewing the module from the back.)

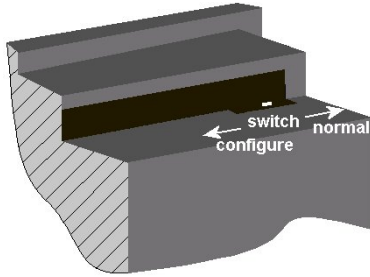

The LED indicator beside the AUTO ✓ button will flash to show that the module is now in configuration mode. While in configuration mode, all normal operation is suspended.

The first configurable parameter is displayed. In this example, the Start delay timer (parameter 0). Is currently set to 5s.

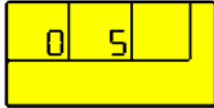

NOTE:- The module must be in STOP mode with the engine at rest in order to enter the configuration editor.

EDITING AN ANALOGUE VALUE

Enter the configuration editor as described above.

Press the + / - buttons to select the parameter you wish to change using the following lists as a reference.

Press the ✓ button to enter adjust mode. The ↑↓ icons in the module display will flash. Pressing the + or - buttons while the ↑↓ icons are flashing will change the selected parameter to the desired value.

Press the ✓ button to 'save' the value. The ↑↓ icons will stop flashing to confirm that it has been saved.

The parameter being displayed in this example is the cooling timer (parameter 7). It's current value is 2.5mins (2mins 30secs).

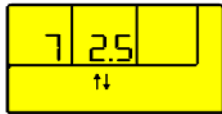

EDITING A 'LIST' VALUE

Some configuration parameters have a list of options to select from. These include input and output settings.

This example shows the setting for oil pressure transducer (parameter 19). It's current setting is 3 ('VDO 0-10bar' from the list shown opposite).

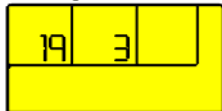

NOTE:- When in adjust mode (indicated by the flashing ↑↓ icons in the module display), pressing the O (stop mode) button will cancel any changes made to the current parameter, reverting to the last 'saved' value. This also exits adjust mode.

NOTE:- To exit the front panel configuration editor at any time, move the Configuration mode switch back into the "normal" position. Ensure you save any changes you have made by pressing the ✓ button first if necessary.

TIMERS & ANALOGUE SETTINGS

Parameter	Type	Default	Max
0 - Start delay	Timer	5s	60s
1 - Preheat	Timer	0s	60s
2 - Crank attempt	Timer	10s	60s
3 - Crank rest	Timer	10s	60s
4 - Safety delay	Timer	8s	60s
5 - Warming up	Timer	0s	60s
6 - Return delay	Timer	30s	60m
7 - Cooling run	Timer	60s	60m
8 - E.T.S. solenoid hold	Timer	0s	60s
9 - Low Oil Pressure	Trip	15PSI	150PSI
10 - High Temperature	Trip	95°C	150°C
11 - Under Speed	Trip	1250RPM	3600RPM
12 - Over Speed	Trip	1750RPM	5000RPM
13 - Underfrequency	Trip	40Hz	60Hz
14 - Overfrequency	Trip	57Hz	72Hz
15 - Charge Alt Failure	Warning	8V DC	25V DC
16 - Flywheel teeth	Value	0	300
17 - CT Primary	Value	500A	6000A

NOTE:- Setting a timer to zero (0) will disable it. Timer settings increment from 0 to 60s in steps of 1s and from 1 minute to the maximum value in steps of 30 seconds (0.5 minutes) (where applicable)

NOTE:- Setting Flywheel teeth to zero (0) will disable magnetic pickup speed sensing. In this instance, engine speed is derived from the alternator output frequency.

NOTE:- CT values increment from 10-100 in steps of 10A, and from 100 to 6000A in steps of 50A. CT secondary must be 5A.

LIST ITEM SETTINGS

Factory default settings are in ***bold italicised*** text.

Parameter	Selections
18 - Alternator poles	0,2,4,6,8
19 - Oil Pressure transducer	0 - Switch close to activate 1 - Switch open to activate 2 - VDO 0-5bar 3 - <i>VDO 0-10bar</i> 4 - Datcon 0-5bar 5 - Datcon 0-10bar
20 - Coolant temp transducer	0 - Switch close to activate 1 - Switch open to activate 2 - <i>VDO 0-120°C</i> 3 - Datcon High
21 - Fast loading enabled	0 - <i>No</i> 1 - Yes
22 - AC system	1 - 1 phase 2 wire 3 - <i>3 phases 4 wires</i>
23 - Oil pressure display units	0 - <i>Bar/PSI</i> 1 - kPa

DSE Model 5110 Automatic Start Engine Management Instrumentation System

CONFIGURABLE OUTPUTS

Factory default settings are in ***bold italicised*** text.

Parameter	Selection
24 - Output 1	0 - Unused
	<i>1 - Preheat mode 0</i>
	2 - Air flap
	3 - Load transfer
	4 - Energise to stop
	5 - Engine running
	6 - Shutdown alarm
	7 - System in auto
	8 - Auxiliary input 1 active
	9 - Auxiliary input 2 active
	10 - Auxiliary input 3 active
	11 - Auxiliary input 4 active
	12 - Auxiliary input 5 active
	13 - Preheat mode 1
	14 - Preheat mode 2
	15 - Preheat mode 3
	16 - Warning alarm
17 - Common alarm	
25 - Output 2	0 - Unused
	1 - Preheat mode 0
	2 - Air flap
	3 - Load transfer
	4 - Energise to stop
	5 - Engine running
	6 - Shutdown alarm
	7 - System in auto
	8 - Auxiliary input 1 active
	9 - Auxiliary input 2 active
	10 - Auxiliary input 3 active
	11 - Auxiliary input 4 active
	12 - Auxiliary input 5 active
	13 - Preheat mode 1
	14 - Preheat mode 2
	15 - Preheat mode 3
	16 - Warning alarm
<i>17 - Common alarm</i>	
26 - Output 3	0 - Unused
	1 - Preheat mode 0
	2 - Air flap
	<i>3 - Load transfer</i>
	4 - Energise to stop
	5 - Engine running
	6 - Shutdown alarm
	7 - System in auto
	8 - Auxiliary input 1 active
	9 - Auxiliary input 2 active
	10 - Auxiliary input 3 active
	11 - Auxiliary input 4 active
	12 - Auxiliary input 5 active
	13 - Preheat mode 1
	14 - Preheat mode 2
	15 - Preheat mode 3
	16 - Warning alarm
17 - Common alarm	

LCD INDICATORS

Factory default settings are in ***bold italicised*** text.

Parameter	Selection
27 - LCD 1	0 - Unused
	1 - Preheat mode 0
	2 - Air flap
	3 - Load transfer
	4 - Energise to stop
	5 - Engine running
	6 - Shutdown alarm
	7 - System in auto
	8 - Auxiliary input 1 active
	<i>9 - Auxiliary input 2 active</i>
	10 - Auxiliary input 3 active
	11 - Auxiliary input 4 active
	12 - Auxiliary input 5 active
	13 - Preheat mode 1
	14 - Preheat mode 2
	15 - Preheat mode 3
	16 - Warning alarm
17 - Common alarm	
28 - LCD 2	0 - Unused
	1 - Preheat mode 0
	2 - Air flap
	3 - Load transfer
	4 - Energise to stop
	5 - Engine running
	6 - Shutdown alarm
	7 - System in auto
	8 - Auxiliary input 1 active
	9 - Auxiliary input 2 active
	<i>10 - Auxiliary input 3 active</i>
	11 - Auxiliary input 4 active
	12 - Auxiliary input 5 active
	13 - Preheat mode 1
	14 - Preheat mode 2
	15 - Preheat mode 3
	16 - Warning alarm
17 - Common alarm	



NOTE:- This page contains configuration details for the “ORIGINAL” 5110 only ! For details of the “NEW” 5110 see the Front Panel configuration section elsewhere in this manual



NOTE:- This section details the configuration editor of the “Original” 5110 module. To identify the “original” and “new” controllers, See the section entitled Identification of “original” 5110 and “new” 5110 elsewhere in this manual.

LCD INDICATORS (CONTINUED)

Factory default settings are in ***bold italicised*** text.

Parameter	Selection
29 - LCD 3	0 - Unused
	1 - Preheat mode 0
	2 - Air flap
	3 - Load transfer
	4 - Energise to stop
	5 - Engine running
	6 - Shutdown alarm
	7 - System in auto
	8 - Auxiliary input 1 active
	9 - Auxiliary input 2 active
	10 - Auxiliary input 3 active
	<i>11 - Auxiliary input 4 active</i>
	12 - Auxiliary input 5 active
	13 - Preheat mode 1
	14 - Preheat mode 2
	15 - Preheat mode 3
	16 - Warning alarm
17 - Common alarm	
30 - LCD 4	0 - Unused
	1 - Preheat mode 0
	2 - Air flap
	3 - Load transfer
	4 - Energise to stop
	5 - Engine running
	6 - Shutdown alarm
	7 - System in auto
	8 - Auxiliary input 1 active
	9 - Auxiliary input 2 active
	10 - Auxiliary input 3 active
	11 - Auxiliary input 4 active
	<i>12 - Auxiliary input 5 active</i>
	13 - Preheat mode 1
	14 - Preheat mode 2
	15 - Preheat mode 3
	16 - Warning alarm
17 - Common alarm	

CONFIGURABLE INPUTS

Factory default settings are in ***bold italicised*** text.

Parameter	Selection
31 - Input 1	0 - Delayed, Warning, close to activate
	1 - Delayed, Warning, open to activate
	2 - Immediate, Warning, close to activate
	3 - Immediate, Warning, open to activate
	4 - Delayed, Shutdown, close to activate
	5 - Delayed, Shutdown, open to activate
	6 - Immediate, Shutdown, close to activate
	7 - Immediate, Shutdown, open to activate
	<i>8 - Remote Start, close to activate</i>
	9 - Remote Start, open to activate
32 - Input 2	<i>0 - Delayed, Warning, close to activate</i>
	1 - Delayed, Warning, open to activate
	2 - Immediate, Warning, close to activate
	3 - Immediate, Warning, open to activate
	4 - Delayed, Shutdown, close to activate
	5 - Delayed, Shutdown, open to activate
	6 - Immediate, Shutdown, close to activate
	7 - Immediate, Shutdown, open to activate
	8 - Electrical trip, close to activate
9 - Electrical trip, open to activate	
33 - Input 3	0 - Warning, Delayed, close to activate
	1 - Warning, Delayed, open to activate
	<i>2 - Warning, Immediate, close to activate</i>
	3 - Warning, Immediate, open to activate
	4 - Shutdown, Delayed, close to activate
	5 - Shutdown, Delayed, open to activate
	6 - Shutdown, Immediate, close to activate
	7 - Immediate, Shutdown, open to activate
	8 - Lamp test, close to activate
9 - Lamp test, open to activate	
34 - Input 4	0 - Delayed, Warning, close to activate
	1 - Delayed, Warning, open to activate
	2 - Immediate, Warning, close to activate
	3 - Immediate, Warning, open to activate
	<i>4 - Delayed, Shutdown, close to activate</i>
	5 - Delayed, Shutdown, open to activate
	6 - Immediate, Shutdown, close to activate
7 - Immediate, Shutdown, open to activate	
35 - Input 5	0 - Delayed, Warning, close to activate
	1 - Delayed, Warning, open to activate
	2 - Immediate, Warning, close to activate
	3 - Immediate, Warning, open to activate
	4 - Delayed, Shutdown, close to activate
	5 - Delayed, Shutdown, open to activate
	<i>6 - Immediate, Shutdown, close to activate</i>
7 - Immediate, Shutdown, open to activate	

NOTE:- The 'preheat modes' selectable for configurable outputs and LCD indicators perform the following actions:

- Preheat mode 0 - Preheat during preheat timer, ceasing at end of preheat timer.
- Preheat mode 1 - Preheat during preheat timer and continue until engine stops cranking.
- Preheat mode 2 - Preheat during preheat timer and continue until the safety delay timer has expired.
- Preheat mode 3 - Preheat during preheat timer and continue until the warming timer has expired.

In addition, in all preheat modes, preheat takes place during the crank rest timer between crank cycles.

NOTE:- This page contains configuration details for the "ORIGINAL" 5110 only ! For details of the "NEW" 5110 see the Front Panel configuration section elsewhere in this manual

NOTE:- This section details the configuration editor of the "Original" 5110 module. To identify the "original" and "new" controllers, See the section entitled Identification of "original" 5110 and "new" 5110 elsewhere in this manual.

18.8 FRONT PANEL CONFIGURATION MK2 5110 V3

ACCESSING THE CONFIGURATION EDITOR

Press the Stop/Reset  and Info  buttons simultaneously.

- The LED beside the AUTO button will flash continuously to indicate that configuration mode has been entered.



- The first configuration setting is displayed:

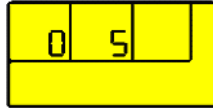

From the configuration table, this example is displaying **Start Delay** (parameter 0). It is currently set to **5 seconds**.

(Factory default settings are shown in the configuration table in **bold italic text**)

EDITING A PARAMETER

- Enter the editor as described above.
- Press + / - to scroll through the parameters to the one you want to change.
- Press ✓ to enter edit mode. The ↑↓ symbol will flash on the display to indicate that edit mode has been entered.
- Press + / - to change the parameter to the desired value.
- Press ✓ to save the value and exit edit mode for this parameter.
- The ↑↓ symbol will be removed from the display to indicate that edit mode has been exited.
- To select another value to edit, press the + / - buttons. Continuing to press the + and - buttons will cycle through the adjustable parameters as shown in the following lists.

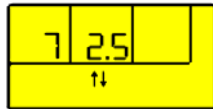

TIMERS & ANALOGUE SETTINGS

Parameter	Type	Default	Max
0 - Start delay	Timer	5s	60s
1 - Preheat	Timer	0s	60s
2 - Crank attempt	Timer	10s	60s
3 - Crank rest	Timer	10s	60s
4 - Safety delay	Timer	8s	60s
5 - Warming up	Timer	0s	60m
6 - Return delay	Timer	30s	60m
7 - Cooling run	Timer	60s	60m
8 - E.T.S. solenoid hold	Timer	0s	60s
9 - Sensor fail delay	Timer	2s	5s
10 - Fail to Stop Delay	Timer	60s	60s
11 - Low Oil Pressure	Trip	15PSI	150PSI
12 - High Temperature	Trip	95°C	150°C
13 - Under Speed	Trip	1250RPM	3600RPM
14 - Over Speed	Trip	1750RPM	5000RPM
15 - Underfrequency	Trip	40Hz	60Hz
16 - Overfrequency	Trip	57Hz	72Hz
17 - Charge Alt Failure	Warning	8V DC	25V DC
18 - Flywheel teeth	Value	0	300
19 - CT Primary	Value	500A	6000A

Parameter	Selections
20 - Alternator poles	0,2,4,6,8
21 - Fast loading enabled	0,1
22 - AC system	0 - 3 phases 4 wire 1 - Single phase 2 wire 2 - 3 phases 3 wire 3 - 2 phases 3 wires
23 - Oil pressure display units	0 - Bar/PSI 1 - kPa

NOTE:- Setting a timer to zero (0) will disable it. Timer settings increment from 0 to 60s in steps of 1s and from 1 minute to the maximum value in steps of 30 seconds (0.5 minutes) (where applicable)

NOTE:- Setting Flywheel teeth to zero (0) will disable magnetic pickup speed sensing. In this instance, engine speed is derived from the alternator output frequency.

NOTE:- CT values increment from 10-100 in steps of 10A, and from 100 to 6000A in steps of 50A. CT secondary must be 5A.

NOTE:- This page contains configuration details for the "new" V3 5110 only ! For details of the "new"(V4) 5110 and "original" 5110 see the Front Panel configuration section elsewhere in this manual

NOTE:- This section details the configuration editor of the "V3" 5110 module. To identify the "original" and "new" (V2 onwards) controllers, See the section entitled Identification of "original" 5110 and "new" 5110 elsewhere in this manual.

CONFIGURABLE OUTPUTS

Factory default settings are in bold italicised text.

Parameter	Selection
24 – Output 1	0 - Unused
	1 - Preheat mode 0
	2 - Air flap
	3 - Close Generator
	4 - Energise to stop
	5 - Engine running
	6 - Shutdown alarm
	7 - System in auto
	8 - Auxiliary input 1 active
	9 - Auxiliary input 2 active
	10 - Auxiliary input 3 active
	11 - Auxiliary input 4 active
	12 - Auxiliary input 5 active
	13 - Preheat mode 1
	14 - Preheat mode 2
	15 - Preheat mode 3
	16 - Warning alarm
17 - Common alarm	
25 – Output 2	0 - Unused
	1 - Preheat mode 0
	2 - Air flap
	3 - Load transfer
	4 - Energise to stop
	5 - Engine running
	6 - Shutdown alarm
	7 - System in auto
	8 - Auxiliary input 1 active
	9 - Auxiliary input 2 active
	10 - Auxiliary input 3 active
	11 - Auxiliary input 4 active
	12 - Auxiliary input 5 active
	13 - Preheat mode 1
	14 - Preheat mode 2
	15 - Preheat mode 3
	16 - Warning alarm
17 - Common alarm	

Factory default settings are in bold italicised text.

Parameter	Selection
26 – Output 3	0 - Unused
	1 - Preheat mode 0
	2 - Air flap
	3 - Load transfer
	4 - Energise to stop
	5 - Engine running
	6 - Shutdown alarm
	7 - System in auto
	8 - Auxiliary input 1 active
	9 - Auxiliary input 2 active
	10 - Auxiliary input 3 active
	11 - Auxiliary input 4 active
	12 - Auxiliary input 5 active
	13 - Preheat mode 1
	14 - Preheat mode 2
	15 - Preheat mode 3
	16 - Warning alarm
17 - Common alarm	

NOTE:- The ‘preheat modes’ selectable for configurable outputs and LCD indicators perform the following actions :

Preheat mode 0 - Preheat during preheat timer, ceasing at end of preheat timer.

Preheat mode 1 - Preheat during preheat timer and continue until engine stops cranking.

Preheat mode 2 - Preheat during preheat timer and continue until the safety delay timer has expired.

Preheat mode 3 - Preheat during preheat timer and continue until the warming timer has expired.

In addition, in all preheat modes, preheat takes place during the crank rest timer between crank cycles.

NOTE:- This page contains configuration details for the “new” V3 5110 only ! For details of the “new”(V4) 5110 and “original” 5110 see the Front Panel configuration section elsewhere in this manual

NOTE:- This section details the configuration editor of the “Original” 5110 module. To identify the “original” and “new” controllers, See the section entitled Identification of “original” 5110 and “new” 5110 elsewhere in this manual.

DSE Model 5110 Automatic Start Engine Management Instrumentation System

LCD INDICATORS

Factory default settings are in bold italicised text.

Parameter	Selection
27 - LCD 1	0 - Unused
	1 - Preheat mode 0
	2 - Air flap
	3 - Load transfer
	4 - Energise to stop
	5 - Engine running
	6 - Shutdown alarm
	7 - System in auto
	8 - Auxiliary input 1 active
	9 - Auxiliary input 2 active
	10 - Auxiliary input 3 active
	11 - Auxiliary input 4 active
	12 - Auxiliary input 5 active
	13 - Preheat mode 1
	14 - Preheat mode 2
	15 - Preheat mode 3
	16 - Warning alarm
17 - Common alarm	
28 - LCD 2	0 - Unused
	1 - Preheat mode 0
	2 - Air flap
	3 - Load transfer
	4 - Energise to stop
	5 - Engine running
	6 - Shutdown alarm
	7 - System in auto
	8 - Auxiliary input 1 active
	9 - Auxiliary input 2 active
	10 - Auxiliary input 3 active
	11 - Auxiliary input 4 active
	12 - Auxiliary input 5 active
	13 - Preheat mode 1
	14 - Preheat mode 2
	15 - Preheat mode 3
	This page
	17 - Common alarm

Factory default settings are in bold italicised text.

Parameter	Selection
29 - LCD 3	0 - Unused
	1 - Preheat mode 0
	2 - Air flap
	3 - Load transfer
	4 - Energise to stop
	5 - Engine running
	6 - Shutdown alarm
	7 - System in auto
	8 - Auxiliary input 1 active
	9 - Auxiliary input 2 active
	10 - Auxiliary input 3 active
	11 - Auxiliary input 4 active
	12 - Auxiliary input 5 active
	13 - Preheat mode 1
	14 - Preheat mode 2
	15 - Preheat mode 3
	16 - Warning alarm
17 - Common alarm	
30 - LCD 4	0 - Unused
	1 - Preheat mode 0
	2 - Air flap
	3 - Load transfer
	4 - Energise to stop
	5 - Engine running
	6 - Shutdown alarm
	7 - System in auto
	8 - Auxiliary input 1 active
	9 - Auxiliary input 2 active
	10 - Auxiliary input 3 active
	11 - Auxiliary input 4 active
	12 - Auxiliary input 5 active
	13 - Preheat mode 1
	14 - Preheat mode 2
	15 - Preheat mode 3
	16 - Warning alarm
17 - Common alarm	

NOTE:- The 'preheat modes' selectable for configurable outputs and LCD indicators perform the following actions :

- Preheat mode 0 - Preheat during preheat timer, ceasing at end of preheat timer.
- Preheat mode 1 - Preheat during preheat timer and continue until engine stops cranking.
- Preheat mode 2 - Preheat during preheat timer and continue until the safety delay timer has expired.
- Preheat mode 3 - Preheat during preheat timer and continue until the warming timer has expired.

In addition, in all preheat modes, preheat takes place during the crank rest timer between crank cycles.

NOTE:- This page contains configuration details for the "new" V3 5110 only ! For details of the "new"(V4) 5110 and "original" 5110 see the Front Panel configuration section elsewhere in this manual

NOTE:- This section details the configuration editor of the "new" 5110 module. To identify the "original" and "new" controllers, See the section entitled Identification of "original" 5110 and "new" 5110 elsewhere in this manual.

CONFIGURABLE INPUTS

Factory default settings are in bold italicised text.

Parameter	Selection
31 – Input 1	0 - Delayed, Warning, close to activate
	1 - Delayed, Warning, open to activate
	2 - Immediate, Warning, close to activate
	3 - Immediate, Warning, open to activate
	4 - Delayed, Shutdown, close to activate
	5 - Delayed, Shutdown, open to activate
	6 - Immediate, Shutdown, close to activate
	7 - Immediate, Shutdown, open to activate
	8 - Remote Start, close to activate
	9 - Remote Start, open to activate
32 – Input 2	0 - Delayed, Warning, close to activate
	1 - Delayed, Warning, open to activate
	2 - Immediate, Warning, close to activate
	3 - Immediate, Warning, open to activate
	4 - Delayed, Shutdown, close to activate
	5 - Delayed, Shutdown, open to activate
	6 - Immediate, Shutdown, close to activate
	7 - Immediate, Shutdown, open to activate
	8 - Electrical trip, close to activate
	9 - Electrical trip, open to activate
33 – Input 3	0 - Warning, Delayed, close to activate
	1 - Warning, Delayed, open to activate
	2 - Warning, Immediate, close to activate
	3 - Warning, Immediate, open to activate
	4 - Shutdown, Delayed, close to activate
	5 - Shutdown, Delayed, open to activate
	6 - Shutdown, Immediate, close to activate
	7 - Immediate, Shutdown, open to activate
	8 - Lamp test, close to activate
	9 - Lamp test, open to activate
34 – Input 4	0 - Delayed, Warning, close to activate
	1 - Delayed, Warning, open to activate
	2 - Immediate, Warning, close to activate
	3 - Immediate, Warning, open to activate
	4 - Delayed, Shutdown, close to activate
	5 - Delayed, Shutdown, open to activate
	6 - Immediate, Shutdown, close to activate
	7 - Immediate, Shutdown, open to activate
35 - Input 5	0 - Delayed, Warning, close to activate
	1 - Delayed, Warning, open to activate
	2 - Immediate, Warning, close to activate
	3 - Immediate, Warning, open to activate
	4 - Delayed, Shutdown, close to activate
	5 - Delayed, Shutdown, open to activate
	6 - Immediate, Shutdown, close to activate
	7 - Immediate, Shutdown, open to activate
	8 - Oil pressure switch, Shutdown, open for low oil pressure
	9 - Oil pressure switch, Shutdown, close for low oil pressure



NOTE:- This page contains configuration details for the “new” V3 5110 only ! For details of the “new”(V4) 5110 and “original” 5110 see the Front Panel configuration section elsewhere in this manual



NOTE:- This section details the configuration editor of the “new” 5110 module. To identify the “original” and “new” controllers, See the section entitled Identification of “original” 5110 and “new” 5110 elsewhere in this manual.