

Projektuebersicht Project General View

Anlage Arrangem.	Anlagenkommentar Arrang. Commentary	FG FG	Funktionsgruppenkommentar Function Group Commentary:	Bl. P.	Blattkommentar Page Commentary	Ort Place	An. Qu.
=Container	3478-562-002	.0	Übersicht / general view	1	Werksnorm	+	1
				2	Übersicht Kabel ST=>HV general view cable CC=>MDB	+	2
				3	Übersicht Kabel ST=>HV=>Schott general view cable CC=>MDB=>bulkhead	+	3
				4	Übersicht Kabel ST=>HV=>Aggregat general view cable CC=>MDB=>aggregate	+	4
				5	Übersicht Kabel ST=>HV=>ContInstallation general view cable CC=>MDB=>ContInstallation	+	5
				6	Übersicht Trafo	+	6
				7	Schaltschränke Hauptverteilung cabinet main distribution board	+HV/MDB	7
				8	Schaltschrank Videobox	+ST-VBox	8
				9	Tableau Steuerstand Leistung panel control cabin power	+ST/CC	9
				10	Klemmkasten Steuerstand Leistung	+ST/CC	10
				11	Schaltschrank Bedienpult Schacht box operation panel shaft	+BP/CP-S	11
				12	Bedienpult Schacht control panel shaft	+BP/CP-S	12
				13	XD40 Aggregat XD40 aggregate	+AGG_XD40	13
				14	Reserve reserve	+	14
				15	1-polige Darstellung single line view	+	15
				16	1-polige Darstellung single line view	+	16
				17	1-polige Darstellung single line view	+	17
				18	1-polige Darstellung single line view	+	18
				19	1-polige Darstellung single line view	+	19
				20	1-polige Darstellung single line view	+	20
				21	1-polige Darstellung single line view	+	21

Datum: 26.08.2011
date:
Bearb. Th
name:



Herrenknecht AG
Schlehenweg 2
D-77963 Schwanau 2
Tel.: 07824 302-0

M-1642-C

Projektuebersicht
Project Gen. View

Auftrags-Nr. order nr.	102857	Stücklisten Nr. Parts No.	25186184	Blatt +Page:	1
Projekt: project:	3478-562-002	nächstes next	2		

Patent-, Gebrauchsmuster- oder Geschmacksmuster-Eintragung vorbehalten. of a patent, utility model or design.
 ausdruecklich gestattet. Zuwendungen vorbehalten. zu Schadenersatz. Alle Rechte fuer den Fall der authorisation is prohibited. Offenders will be held liable for the payment of damages. All rights reserved in the event of the grant
 Weitergabe sowie Vervielfaeltigung dieses Dokuments, Verwertung und Mitteilung seines Inhalts sind verboten, soweit nicht The reproduction, distribution and utilization of this document as well as the communication of its contents to others without express

Projektuebersicht Project General View

1	2	3	4	5	6	7	8
Anlage Arrangem.	Anlagenkommentar Arrang. Commentary	FG FG	Funktionsgruppenkommentar Function Group Commentary:	Bl. P.	Blattkommentar Page Commentary	Ort Place	An. Qu.
=Container	3478-562-002	.0	Übersicht / general view	22	Reserve reserve	+	22
				23	Busübersicht bus overview	+	23
				24	Reserve reserve	+	24
		.1	Einspeisung / supply main switch	1	Einspeisung, Hauptschalter supply, main switch	+HV/MDB	25
				2	Hauptschalter Ein/Aus main switch on/off	+ST/CC	26
				3	Steuerung Hauptschalter Ein/Aus control / main switch on/off	+HV/MDB	27
				4	Unterspannungsspule, Hauptschalter E/A	+HV/MDB	28
				5	Auswertung Hauptschalter interpretation main switch	+	29
				6	Fehlerstromüberwachung fault current control	+HV/MDB	30
				7	Phasenfolgeüberwachung phase sequence control	+HV/MDB	31
				8	Steuerspannung vor Hauptschalter zu ST control voltage before MS to CC	+HV/MDB	32
				9	Vorsicherung Kleinverbraucher prefuse small consumers	+HV/MDB	33
				10	Abschaltung Kleinverbraucher cut-off small consumer	+HV/MDB	34
				11	Netzdatenmessgerät mains data measurement device	+ST/CC	35
				12	Reserve reserve	+	36
		.2	Einspeisung extern / supply external	1	Einspeisung 400VAC TN-S Netz supply 400VAC TN-S system	+ST/CC	37
				2	Abgang 400VAC TN-S Netz zu HV outleif 400VAC TN-S system to MDB	+ST/CC	38
				3	Einspeisung 230VAC HV supply 230VAC MDB	+HV/MDB	39
				4	Reserve reserve	+	40
		.6	Installation (Ventilation, Sockets, Light)	1	Steckdosenkombination socket combination	+HV/MDB	41
				2	Reserve reserve	+	42

Datum: 26.08.2011
date:
Bearb. Th
name:



Herrenknecht AG
Schlehenweg 2
D-77963 Schwanau 2
Tel.: 07824 302-0

M-1642-C

Projektuebersicht
Project Gen. View

Auftrags-Nr. order nr. 102857	Stücklisten Nr. Parts No. 25186184	Blatt +Page: 2
Projekt: 3478-562-002	nächstes next 3	

Patent-, Gebrauchsmuster- oder Geschmacksmuster-Eintragung vorbehalten. of a patent, utility model or design.

ausdrücklich gestattet. Zuwiderhandlungen verpflichten zu Schadenersatz. Alle Rechte für den Fall der Auhonoration ist prohibited. Offenders will be held liable for the payment of damages. All rights reserved in the event of the grant

Weitergabe sowie Vervielfältigung dieses Dokuments, Verwertung und Mitteilung seines Inhalts sind verboten, soweit nicht The reproduction, distribution and utilization of this document as well as the communication of its contents to others without express

Projektuebersicht Project General View

1	2	3	4	5	6	7	8
Anlage Arrangem.	Anlagenkommentar Arrang. Commentary	FG FG	Funktionsgruppenkommentar Function Group Commentary:	Bl. P.	Blattkommentar Page Commentary	Ort Place	An. Qu.
=Container	3478-562-002	.6	Installation (Ventilation,Sockets,Light)	3	Versorgungsspannung Lüftung Distribution voltage ventilation	+HV/MDB	43
				4	Lüftung Container ventilation container	+HV/MDB	44
				5	Reserve reserve	+	45
				6	Heizung HV, Versorgungssp. Steuerstand heating MDB, power supply control cabin	+HV/MDB	46
				7	Beleuchtung Schaltschrank HV lighting cabinet MDB	+HV/MDB	47
				8	Steckdosen Hauptverteilung sockets main distribution board	+HV/MDB	48
				9	Beleuchtung Container light container	+HV/MDB	49
				10	Beleuchtung Container light container	+Con	50
				11	Reserve reserve	+	51
				12	Heizung/Klimaanlage Steuerraum heating/air condition steering room	+HV/MDB	52
		.8	Steuerspannung / control voltage	1	Steuerspannung 230VAC nach Hauptschalter control voltage 230VAC behind main switch	+HV/MDB	53
				2	Steuerspannung 230VAC vor Hauptschalter control voltage 230VAC before main switch	+HV/MDB	54
				3	Reserve reserve	+	55
				4	Steuerspannung 230VAC vor Hauptschalter control voltage 230VAC before main switch	+HV/MDB	56
				5	Steuerspannung 24VDC vor Hauptschalter control voltage 24VDC before main switch	+HV/MDB	57
				6	Steuerspannung 24VDC Ventile control voltage 24VDC valves	+HV/MDB	58
				7	Steuerspannung 24VDC vor Hauptschalter control voltage 24VDC before main switch	+HV/MDB	59
				8	Steuerspannung 24VDC vor Hauptschalter control voltage 24VDC before main switch	+HV/MDB	60
				9	Steuerung Ein/Aus control on/off	+HV/MDB	61
				10	Steuerung Ein/Aus control on/off	+ST/CC	62
				11	Steuerstand in Container control cabin in container	+HV/MDB	63

Datum: 26.08.2011
date:
Bearb. Th
name:



Herrenknecht AG
Schlehenweg 2
D-77963 Schwanau 2
Tel.: 07824 302-0

M-1642-C

Projektuebersicht
Project Gen. View

Auftrags-Nr. order nr. 102857	Stücklisten Nr. Parts No. 25186184	Blatt +Page: 3
Projekt: 3478-562-002	nächstes next 4	

Patent-, Gebrauchsmuster- oder Geschmacksmuster-Eintragung vorbehalten. of a patent, utility model or design.
 ausdrücklich gestattet. Zuwiderhandlungen verpflichten zu Schadenersatz. Alle Rechte für den Fall der Auhonorisation ist prohibited. Offenders will be held liable for the payment of damages. All rights reserved in the event of the grant
 Weitergabe sowie Vervielfältigung dieses Dokuments, Verwertung und Mitteilung seines Inhalts sind verboten, soweit nicht The reproduction, distribution and utilization of this document as well as the communication of its contents to others without express

Projektuebersicht Project General View

Anlage Arrangem.	Anlagenkommentar Arrang. Commentary	FG FG	Funktionsgruppenkommentar Function Group Commentary:	Bf. P.	Blattkommentar Page Commentary	Ort Place	An. Qu.
=Container	3478-562-002	.8	Steuerspannung / control voltage	12	Wartungsschalter XD40 maintenance switch XD40	+HV/MDB	64
		.9	SPS-Konfiguration / PLC-configuration	1	SPS-Anschaltung Steuerstand PLC interface connection Beckhoff	+ST/CC	65
				2	SPS S7-300 CPU PLC S7-300 CPU	+HV/MDB	66
				3	Profibus-Repeater profibus-Repeater	+HV/MDB	67
				4	Profibus-Repeater profibus-Repeater	+HV/MDB	68
				5	Reserve reserve	+	69
				6	Reserve reserve	+	70
				7	SPS-Anschaltung Hauptverteilung PLC interface connection main distribution	+HV/MDB	71
				8	SPS PLC	+HV/MDB	72
				9	SPS-Anschaltung XD Aggregat PLC-interface connection XD aggregate	+AGG_XD40	73
				10	SPS XD Aggregat PLC XD aggregate	+AGG_XD40	74
				11	SPS-Anschaltung BP-Schacht PLC-interface connection control panel shaft	+BP/CP-S	75
				12	SPS BP-Schacht, Netzteilklemme 10VDC	+BP/CP-S	76
		.10	Abgänge, Vorsicherung / outlets, prefuse	1	Spannungsvers. Maschine Ein/Aus Power Supply Machine On/Off	+ST/CC	77
				2	Spannungsversorgung Steuerstand 325VDC power supply control cabin 325VDC	+HV/MDB	78
				3	Isolationsüberwachung insulation control	+HV/MDB	79
				4	Spannungsversorgung Maschine 400VAC power supply machine 400VAC	+HV/MDB	80
				5	Kompressor compressor	+HV/MDB	81
				6	Abgang Reserve 32A Option outlet reserve 32A option	+HV/MDB	82
				7	Kompressor Ein/Aus compressor on/off	+ST/CC	83
				8	Spannungsvers. Maschine Ein/Aus Power Supply Machine On/Off	+BP/CP-S	84

Datum: 26.08.2011
date:
Bearb. Th
name:



Herrenknecht AG
Schlehenweg 2
D-77963 Schwanau 2
Tel.: 07824 302-0

M-1642-C

Projektuebersicht
Project Gen. View

Auftrags-Nr. order nr. 102857	Stücklisten Nr. Parts No. 25186184	Blatt +Page: 4
Projekt: 3478-562-002	nächstes next 5	

Patent-, Gebrauchsmuster- oder Geschmacksmuster-Eintragung vorbehalten. or a patent, utility model or design.

ausdrücklich gestattet. Zuwiderhandlungen verpflichten zu Schadenersatz. Alle Rechte für den Fall der Auhonisation ist prohibited. Offenders will be held liable for the payment of damages. All rights reserved in the event of the grant

Weitergabe sowie Vervielfältigung dieses Dokuments, Verwertung und Mitteilung seines Inhalts sind verboten, soweit nicht The reproduction, distribution and utilization of this document as well as the communication of its contents to others without express

Projektuebersicht Project General View

Anlage Arrangem.	Anlagenkommentar Arrang. Commentary	FG FG	Funktionsgruppenkommentar Function Group Commentary:	Bl. P.	Blattkommentar Page Commentary	Ort Place	An. Qu.
=Container	3478-562-002	.11	Filter-, Tanküberw./filter-, tank contr.	1	Öelniveau min/max ok oil level min/max ok	+AGG_XD40	85
				2	Saug-/Ruecklauffilter suction-/return filter	+AGG_XD40	86
				3	Tanküberwachung tank control	+AGG_XD40	87
				4	Reserve reserve	+	88
				5	Öelkuehler 3kW oil cooler 3kW	+HV/MDB	89
				6	Reserve reserve	+	90
		.13	Abbauwerkzeug / cutting head	1	Versorgung Abbawerkzeug 950V supply cutting head 950VAC	+HV/MDB	91
				2	Trafo Abbawerkzeug Betrieb transformer cutting head operation	+HV/MDB	92
				3	Überwachung Trafo 950V monitoring transformer 950VAC	+HV/MDB	93
				4	Reserve reserve	+	94
		.15	Vortriebspr., Dehner/thrust pr., ljack	1	Vortriebspumpe 2 Container thrust pump 2 container	+HV/MDB	95
				2	Vortriebspumpe 2 Container Betrieb thrust pump 2 container operation	+HV/MDB	96
				3	Reserve reserve	+	97
				4	Spannungsversorgung BP-Schacht power supply CP-shaft	+HV/MDB	98
				5	Spannungsversorgung BP-Schacht power supply CP-shaft	+BP/CP-S	99
				6	Reserve reserve	+	100
				7	Vortriebspumpe 2 Container Ein/Aus thrust pump 2 container on/off	+BP/CP-S	101
				8	Sollwert Vortriebspressen Schachtpult Specified value thrust cylinder shaft panel	+BP/CP-S	102
				9	Vortriebspressen Vor/zurück thrust cylinder extend/retract	+BP/CP-S	103
				10	Reserve reserve	+	104
				11	Ventil Vortriebspresse / Hochdruckfilter valve thrust cylinder / high pressure filter	+AGG_XD40	105

Datum: 26.08.2011
date:
Bearb. Th
name:



Herrenknecht AG
Schlehenweg 2
D-77963 Schwanau 2
Tel.: 07824 302-0

M-1642-C

Projektuebersicht
Project Gen. View

Auftrags-Nr.
order nr.
Projekt:
project:

102857

3478-562-002

Stücklisten Nr.
Parts No.

25186184

Blatt
+Page: 5

nächstes
next 6

Patent-, Gebrauchsmuster- oder
Geschmacksmuster-Eintragung vorbehalten.
of a patent, utility model or design.

ausdrücklich gestattet. Zuwiderhandlungen verpflichten
zu Schadensersatz. Alle Rechte fuer den Fall der
Auhonisation is prohibited. Offenders will be held liable for the
payment of damages. All rights reserved in the event of the grant

Weitergabe sowie Vervielfaeltigung dieses Dokuments, Verwertung
und Mitteilung seines Inhalts sind verboten, soweit nicht
The reproduction, distribution and utilization of this document as
well as the communication of its contents to others without express

Projektuebersicht Project General View

Anlage Arrangem.	Anlagenkommentar Arrang. Commentary	FG FG	Funktionsgruppenkommentar Function Group Commentary:	Bl. P.	Blattkommentar Page Commentary	Ort Place	An. Qu.
=Container	3478-562-002	.15	Vortriebspr., Dehner/thrust pr., ljack	12	Druck Vortriebspressen pressure thrust cylinder	+AGG_XD40	106
				13	Dehner 11 interjack 11	+AGG_XD40	107
				14	Dehner 12 interjack 12	+AGG_XD40	108
				15	Dehner 13 interjack 13	+AGG_XD40	109
				16	Dehner 14 interjack 14	+AGG_XD40	110
				17	Betriebsstunden Vortriebspumpe operating hours thrust pump	+HV/MDB	111
				18	Reserve reserve	+	112
		.19	Maschinenwinde / machine winch	1	Bedienhoeheit/Sollwert Schachtwinde	+BP/CP-S	113
				2	Schachtwinde auf-/abwickeln shaft winch wind up/down	+BP/CP-S	114
				3	Betriebsmeldung Winde	+BP/CP-S	115
				4	Reserve reserve	+	116
				5	Schachtwinde auf-/abwickeln shaft winch wind up/down	+AGG_XD40	117
				6	Reserve reserve	+	118
		.22	Emergency-Stop / Not-Aus	1	Not-Halt	+HV/MDB	119
				2	Not-Halt	+HV/MDB	120
				3	Not-Halt XD40 emergency-stop XD40	+AGG_XD40	121
				4	Not-Halt BP-Schacht	+BP/CP-S	122
				5	Reset Not-Halt Relais	+HV/MDB	123
				6	Not-Halt/Wartungsschalter Steuerstand	+ST/CC	124
				7	Reset/Störung Not-Halt	+ST/CC	125
				8	Reserve reserve	+	126

Datum: 26.08.2011
date:
Bearb. Th
name:



Herrenknecht AG
Schlehenweg 2
D-77963 Schwanau 2
Tel.: 07824 302-0

M-1642-C

Projektuebersicht
Project Gen. View

Auftrags-Nr. order nr. 102857	Stücklisten Nr. Parts No. 25186184	Blatt +Page: 6
Projekt: 3478-562-002	nächstes next 7	

Patent-, Gebrauchsmuster- oder Geschmacksmuster-Eintragung vorbehalten. of a patent, utility model or design.
 ausdruecklich gestattet. Zuwendungen vorbehalten. zu Schadenersatz. Alle Rechte fuer den Fall der authorisation is prohibited. Offenders will be held liable for the payment of damages. All rights reserved in the event of the grant
 Weitergabe sowie Vervielfaeltigung dieses Dokuments, Verwertung und Mitteilung seines Inhalts sind verboten, soweit nicht The reproduction, distribution and utilization of this document as well as the communication of its contents to others without express

Projektuebersicht Project General View

1	2	3	4	5	6	7	8
Anlage Arrangem.	Anlagenkommentar Arrang. Commentary	FG FG	Funktionsgruppenkommentar Function Group Commentary:	Bl. P.	Blattkommentar Page Commentary	Ort Place	An. Qu.
=Container	3478-562-002	.23	Bentonitschmier. / bentonite lubrication	1	Bentonit Pumpe 1 bentonite pump 1	+HV/MDB	127
				2	Reserve reserve	+	128
				3	Reserve reserve	+	129
				4	Reserve reserve	+	130
				5	Profibus Gateway System 1/1 process data highway gateway system 1/1	+HV/MDB	131
				6	Reserve reserve	+	132
				7	Bentonit Spannung bentonite voltage	+HV/MDB	133
				8	Einspeisung Schmieresystem 1 supply lubrication system 1	+HV/MDB	134
				9	Reserve reserve	+	135
				10	Bentonit Durchfluss/Druck System 1 bentonite flow/pressure system 1	+HV/MDB	136
		.31	Sammelstörung / general fault	1	Reset, Störung allgemein reset, general fault	+ST/CC	137
				2	Lampentest Steuerstand lamp check control cabin	+ST/CC	138
				3	Sammelstörung vorhanden general fault existing	+BP/CP-S	139
				4	Lampentest BP-Schacht lamp check CP-shaft	+BP/CP-S	140
		.32	Tunnel Kommunik. / tunnel communication	1	Datenverbindung zu Maschine data connection to machine	+HV/MDB	141
				2	Datenverbindung ST<=>HV	+HV/MDB	142
				3	Telefone Container phones container	+HV/MDB	143
				4	Kommunikations-Schnittstelle zu Cont.	+HV/MDB	144
		.33	Videüberwachung / video controlling	1	Kamera Maschine camera machine	+HV/MDB	145
				2	Videokamera 3 Schacht unten	+HV/MDB	146
				3	Videokamera 4 Schacht oben	+HV/MDB	147

Datum: 26.08.2011
date:
Bearb. Th
name:



Herrenknecht AG
Schlehenweg 2
D-77963 Schwanau 2
Tel.: 07824 302-0

M-1642-C

Projektuebersicht
Project Gen. View

Auftrags-Nr.
order nr.
Projekt:
project:

102857

Stücklisten Nr.
Parts No.

25186184

Blatt
+Page:

nächstes
next

8

Projektuebersicht Project General View

Anlage Arrangem.	Anlagenkommentar Arrang. Commentary	FG FG	Funktionsgruppenkommentar Function Group Commentary:	Bl. P.	Blattkommentar Page Commentary	Ort Place	An. Qu.
=Container	3478-562-002	.33	Videüberwachung / video controlling	4	Verbindung zu Empfänger/Monitor Quad	+HV/MDB	148
				5	Videosystem Ein/Aus	+HV/MDB	149
				6	Reserve reserve	+	150
				7	Videosystem Ein/Aus	+ST/CC	151
				8	Reserve reserve	+	152
				9	Kamera 1 camera 1	+ST-VBox	153
				10	Kamera 2 camera 2	+ST-VBox	154
				11	Kamera 3 camera 3	+ST-VBox	155
				12	Kamera 4 camera 4	+ST-VBox	156
		.34	Vermessung / guidance system	1	Vermessungssystem guidance system	+HV/MDB	157
				2	Reserve reserve	+	158
				3	Laser Ein/Aus laser on/off	+BP/CP-S	159
				4	Vermessungssystem guidance system	+HV/MDB	160
		.35	Datenerfass., PC / datacollect., computer	1	DSL Modem	+HV/MDB	161
				2	CAN-Anschaltung CAN-interface	+HV/MDB	162
				3	PG/PC Interface PG/PC interface	+ST/CC	163
				4	Reserve reserve	+	164
		.36	Rauchmelder / smoke detectors	1	Rauchmelder Container smoke detector container	+HV/MDB	165
				2	Reserve reserve	+	166

Datum: 26.08.2011
date:
Bearb. Th
name:



Herrenknecht AG
Schlehenweg 2
D-77963 Schwanau 2
Tel.: 07824 302-0

M-1642-C

Projektuebersicht
Project Gen. View

Auftrags-Nr. order nr. 102857	Stücklisten Nr. Parts No. 25186184	Blatt +Page: 8
Projekt: 3478-562-002	nächstes next -	

Patent-, Gebrauchsmuster- oder Geschmacksmuster-Eintragung vorbehalten. of a patent, utility model or design.
 ausdruecklich gestattet. Zuwiderhandlungen verpflichten zu Schadenersatz. Alle Rechte fuer den Fall der Auhorisation is prohibited. Offenders will be held liable for the payment of damages. All rights reserved in the event of the grant
 Weitergabe sowie Vervielfaeltigung dieses Dokuments, Verwertung und Mitteilung seines Inhalts sind verboten, soweit nicht The reproduction, distribution and utilization of this document as well as the communication of its contents to others without express

Titelblatt front page

Elektroschema: 3478-562-002
 electric scheme:
 Projekt: M-1642-C
 project:
 Baustelle:
 building site:

Hinweis: Dies ist die Werksnorm der Fa. HERRENKNECHT unter Berücksichtigung der
 notice: VDE-Bestimmungen
 This is the company standard of HERRENKNECHT in deference to the
 Germany National VDE-Rules.
 ! Sonderbestimmungen für Exportländer sind im Zweifel nachzufragen !
 ! Special rules for Export are to ask in case of doubt !

Drahtfarben :
wire colours :

Schwarz Rot Rot/Weiss Blau Blau/Weiss Violett Violett/Weiss Orange	:Hauptstromkreise Wechsel und Gleichspannung :Steuerstromkreise nach Trafo L, 230V Wechselspannung :Steuerstromkreise nach Trafo N, 230V Wechselspannung :Steuerstromkreise Gleichspannung (+) <=50V :Steuerstromkreise Gleichspannung (-) <=50V :Steuerstromkreise nach Trafo L, Wechselspannung <=50V :Steuerstromkreise nach Trafo N, Wechselspannung <=50V :Fremdspannungen von Fremdschaltzschränken und Steuerstromkreise die unter Spannung bleiben bei ausgeschaltetem Hauptschalter :N von Fremdspannungen und Steuerstromkreisen vor Hauptschalter	Verriegelungsstromkreise interlock circuits	:230V Wechselspannung bleiben ROT, auch wenn sie in einen anderen Schaltschrank geführt werden. (z.B. UV>Steuerstand) 230V Altern. current remains RED, even though it may be guided into another electr.cabinet. (e.g. DB>contr. cabinet)
Orange/Weiss	:N von Fremdspannungen und Steuerstromkreisen vor Hauptschalter	Verriegelungsstromkreise interlock circuits	:24V Wechselspannung bleiben VIOLETT, auch wenn sie in einen anderen Schaltschrank geführt werden. (z.B. HV>JV) 24V alternating current remains VIOLET, even though it may be guided into another electr. cabinet.
Weiss black red red/white blue blue/white violett violett/white orange	:Meßstromkreise aller Art main circuit altern. and direct voltage control current circuit to transf. L, 230V altern. current control current circuit to transf. N, 230V altern. current control current direct voltage (+) <=50V control current direct voltage (-) <=50V control current circuit to transf. L, altern. current <=50V control current circuit to transf. N, altern. current <=50V interf. voltage from external contr. cabinets and control current circuits remaining under voltage with switched off main switch	Verriegelungsstromkreise interlock circuits	:24V Gleichspannung bleiben BLAU, auch wenn sie in einen anderen Schaltschrank geführt werden. (z.B. HV>Steuerstand) 24V Direct current remains BLUE, even though it may be guided into another electr. cabinet.
orange/white white	N from interf. voltage and control current circuit before main switch measurement circuits of many kind		Die Farben GRÜN und GELB dürfen nicht verwendet werden. Die PE-/PEN-Leiter müssen GRÜN/GELB sein. Bei Einspeisung mit N muss der N BLAU sein. The Colours GREEN and YELLOW are not allowed to use The PE-/PEN conducters must be GREEN/YELLOW. If power Supply with neutral (N) then this wire must be blue.

Datum date:	26.08.2011	Bearb. name:	Th	Ausdruck-Datum: printout-date:	14.12.11	 Herrenknecht AG Schlehenweg 2 D-77963 Schwanau 2 Tel.: 07824 302-0 Fax.: 07824 3403	M-1642-C	Auftr.-Nr.: Order No:	102857	Fg.-Gruppe: funct.-group:	.0	Blatt-Nr.: page-nr.:	1
Gepr. checked		Norm						Zchg.-Nr.: drawing-no.:	3478-562-002				

Steuerstand
Control Cabin

Hauptverteilung
main distribution board

Steuerstand MA
Control Cabin MA
in Container

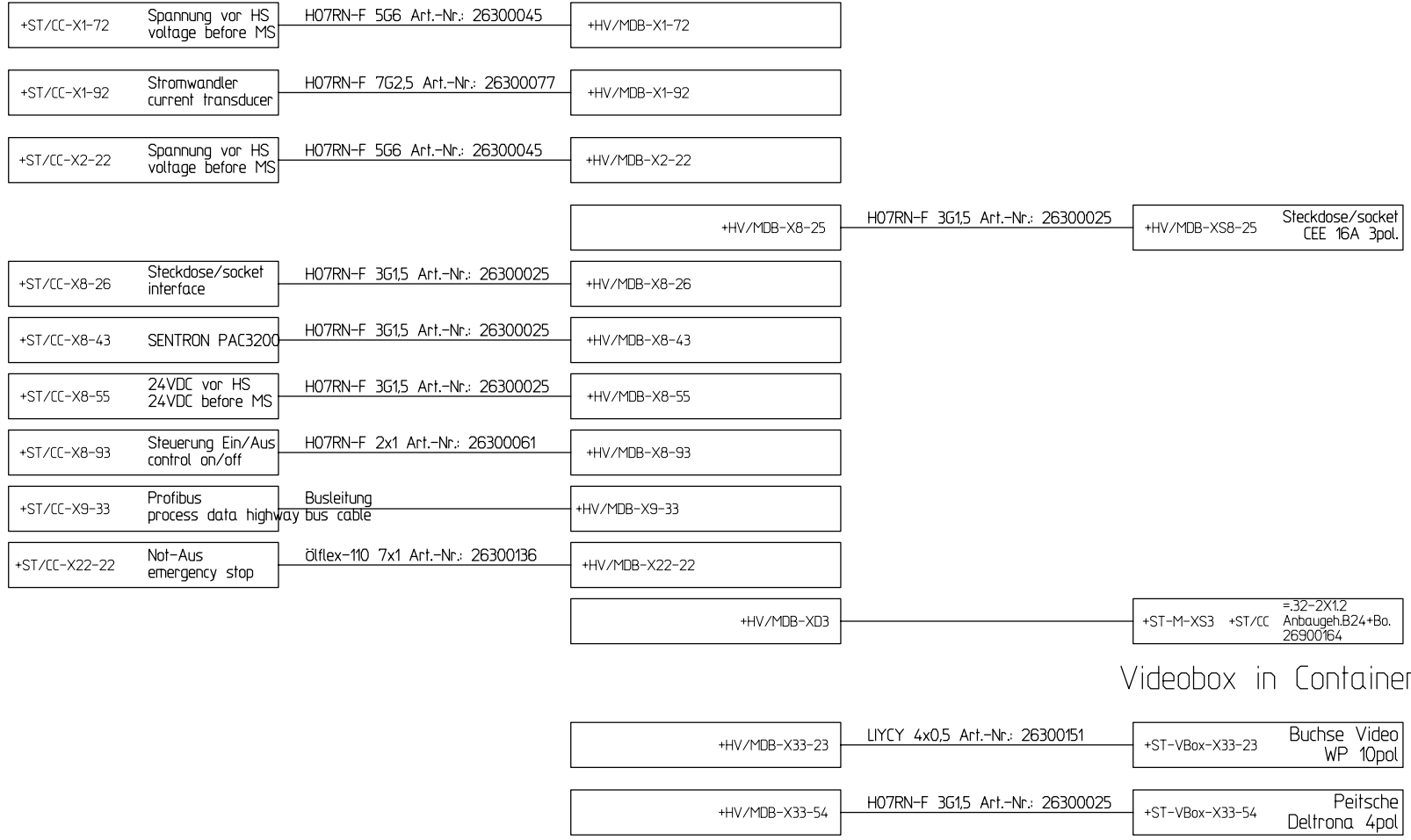

Versorgung 230VAC
supply 230VAC

Videobox in Container

Patent-, Gebrauchsmuster- oder Geschmacksmuster-Eintragung vorbehalten. of a patent, utility model or design.
 ausdrucklich gestattet. Zuwiderhandlungen verpflichten zu Schadenersatz. Alle Rechte fuer den Fall der Auhorisation is prohibited. Offenders will be held liable for the payment of damages. All rights reserved in the event of the grant
 Weitergabe sowie Vervielfaeltigung dieses Dokuments, Verwertung und Mitteilung seines Inhalts sind verboten, soweit nicht The reproduction, distribution and utilization of this document as well as the communication of its contents to others without express

			CAD! KEINE MANUELLEN AENDERUNGEN! CAD! DONT CHANGE MANUAL		 Herrenknecht AG Schlehenweg 2 D-77963 Schwanau 2 Tel.: 07824 302-0 Fax.: 07824 3403 Info@Herrenknecht.de	Projekt: M-1642-C =Container		Übersicht Kabel ST=>HV general view cable CC=>MDB Übersicht / general view		Stueckliste: parts list: 25186184		Fg.-Gruppe: funct.-group: .0		Blatt-Nr.: page-nr.: 2		
Index	Änderung-Nr. Change No.:	Datum / Name date / name	Ausdruck-Datum: printout-date: 14.12.11			Zn.-Nr. / drawn-nr.:	3478-562-002-0		Datum: date:	26.08.2011		Bearb. name:	Th		letzte Änderung: last modification:	IB-Revision 14.12.11 Th

Steuerstand
Control Cabin

Hauptverteilung
main distribution board

Schott

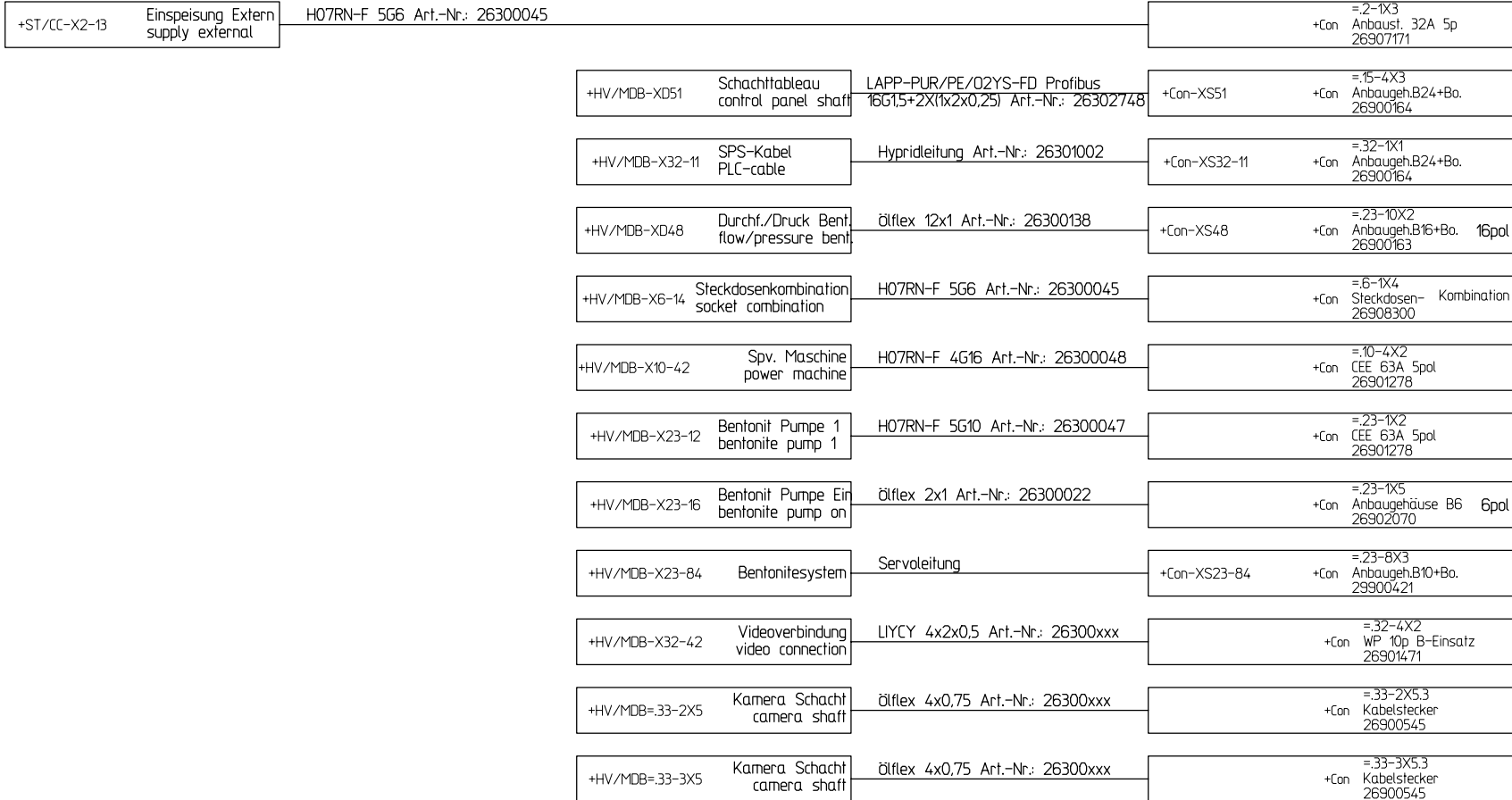

			CAD! KEINE MANUELLEN ÄNDERUNGEN! CAD! DONT CHANGE MANUAL	 Herrenknecht AG Schlehenweg 2 D-77963 Schwanaau 2 Tel.: 07824 302-0 Fax.: 07824 3403 Info@Herrenknecht.de	Projekt: project: M-1642-C	Übersicht Kabel ST=>HV=>Schott general view cable CC=>MDB=>bulkhead		Stueckliste: parts list: 25186184	Fg.-Gruppe: func.-group: .0	Blatt-Nr.: page-nr.: 3
Index Index	Änderung-Nr. Change No.:	Datum / Name date / name	Ausdruck-Datum: printout-date: 14.12.11		Zn.-Nr.: drawn-nr.: 3478-562-002-0	Datum: date: 26.08.2011	Bearb. name: Th	letzte Änderung: last modification: IB-Revision 14.12.11 Th	Blatt-Global: page-global: 3/166	von from 24

Patent-, Gebrauchsmuster- oder Geschmacksmuster-Eintragung vorbehalten. of a patent, utility model or design.
 ausdruecklich gestattet. Zuwendungen vorbehalten zu Schadenersatz. Alle Rechte fuer den Fall der authorisation is prohibited. Others will be held liable for the payment of damages. All rights reserved in the event of the grant
 Weitergabe sowie Vervielfaeltigung dieses Dokuments, Verwertung und Mitteilung seines Inhalts sind verboten, soweit nicht The reproduction, distribution and utilization of this document as well as the communication of its contents to others without express

Steuerstand
Control Cabin

Hauptverteilung
main distribution board

Aggregat
aggregate

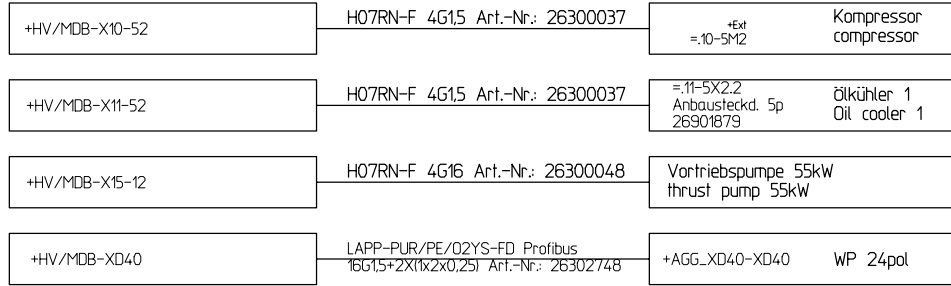

Patent-, Gebrauchsmuster- oder Geschmacksmuster-Eintragung vorbehalten. of a patent, utility model or design.
 ausdruecklich gestattet. Zuwiderhandlungen verpflichten zu Schadensersatz. Alle Rechte fuer den Fall der Auhorisation ist prohibited. Offenders will be held liable for the payment of damages. All rights reserved in the event of the grant
 Weitergabe sowie Vervielfaeltigung dieses Dokuments, Verwertung und Mitteilung seines Inhalts sind verboten, soweit nicht The reproduction, distribution and utilization of this document as well as the communication of its contents to others without express

CAD! KEINE MANUELLEN AENDERUNGEN ! CAD! DONT CHANGE MANUAL			 Herrenknecht AG Schlehenweg 2 D-77963 Schwanau 2 Tel.: 07824 302-0 Fax.: 07824 3403 Info@Herrenknecht.de	Projekt: M-1642-C =Container		Übersicht Kabel ST=>HV=>Aggregat general view cable CC=>MDB=>aggregate Übersicht / general view		Stueckliste: parts list: 25186184		Fg.-Gruppe: funct.-group: .0		Blatt-Nr.: page-nr.: 4	
Ausdruck-Datum: printout-date: 14.12.11				Zn.-Nr.: drawn-nr.: 3478-562-002-0		Datum: date: 26.08.2011		Bearb.: name: Th		letzte Aenderung: last modification: 14.12.11 Th		Blatt-Global: von 24 page-global: from 4/166	

Hauptverteilung main distribution board

Container Installation

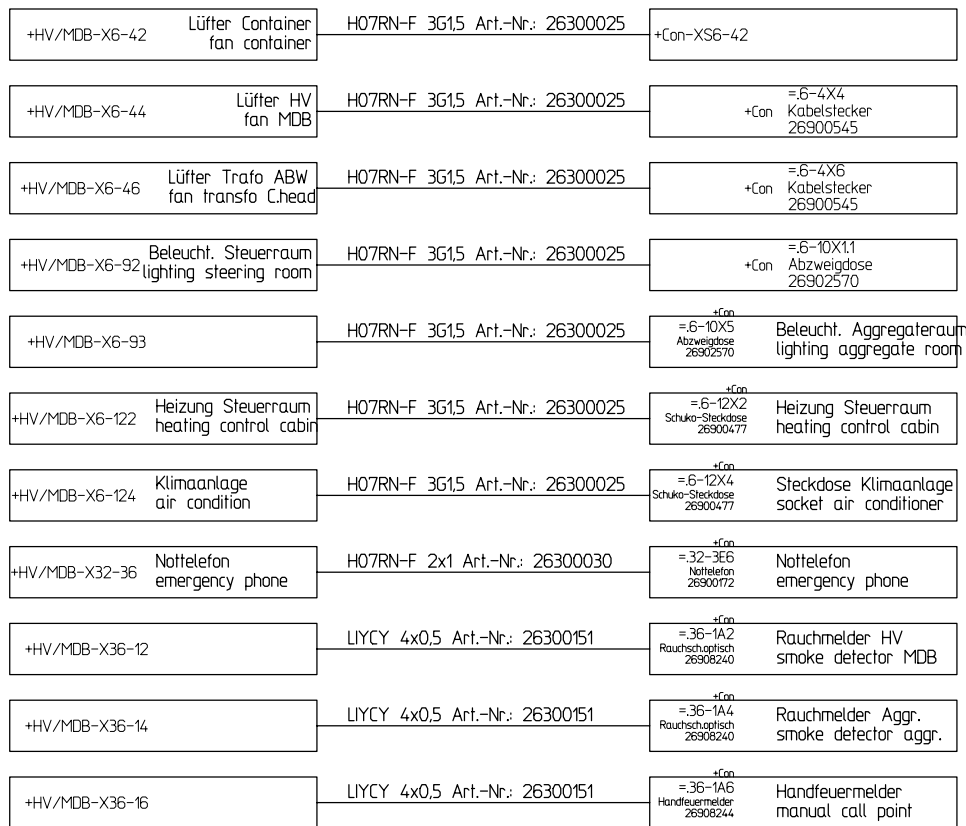

Patent-, Gebrauchsmuster- oder Geschmacksmuster-Eintragung vorbehalten.
 of a patent, utility model or design.
 ausdruecklich gestattet. Zuwiderhandlungen verpflichten zu Schadensersatz. Alle Rechte fuer den Fall der autorization is prohibited. Offenders will be held liable for the payment of damages. All rights reserved in the event of the grant
 Weitergabe sowie Vervielfaeltigung dieses Dokuments, Verwertung und Mitteilung seines Inhalts sind verboten, soweit nicht The reproduction, distribution and utilization of this document as well as the communication of its contents to others without express

CAD! KEINE MANUELLEN AENDERUNGEN! DON'T CHANGE MANUAL Ausdruck-Datum: printout-date: 14.12.11			 Herrenknecht AG Schlehenweg 2 D-77963 Schwanau 2 Tel.: 07824 302-0 Fax.: 07824 3403 Info@Herrenknecht.de	Projekt: M-1642-C =Container		Übersicht Kabel ST=>HV=>Confinstallation general view cable CC=>MDB=>Confinstallation Übersicht / general view		Stueckliste: parts list: 25186184		Fg.-Gruppe: funct.-group: .0		Blatt-Nr.: page-nr.: 5	
Index	Aenderung-Nr. Change No.:	Datum / Name date / name		Zn.-Nr.: drawn-nr.:	Datum: date:	Bearb.: name:	letzte Aenderung: last modification: IB-Revision 14.12.11 Th		Blatt-Global: page-global: 5/166		von from 24		

Patent-, Gebrauchsmuster- oder Geschmacksmuster-Eintragung vorbehalten. of a patent, utility model or design.
 ausdrücklich gestattet. Zuwiderhandlungen verpflichten zu Schadenersatz. Alle Rechte für den Fall der autorization is prohibited. Offenders will be held liable for the payment of damages. All rights reserved in the event of the grant
 Weitergabe sowie Vervielfältigung dieses Dokuments, Verwertung und Mitteilung seines Inhalts sind verboten, soweit nicht The reproduction, distribution and utilization of this document as well as the communication of its contents to others without express

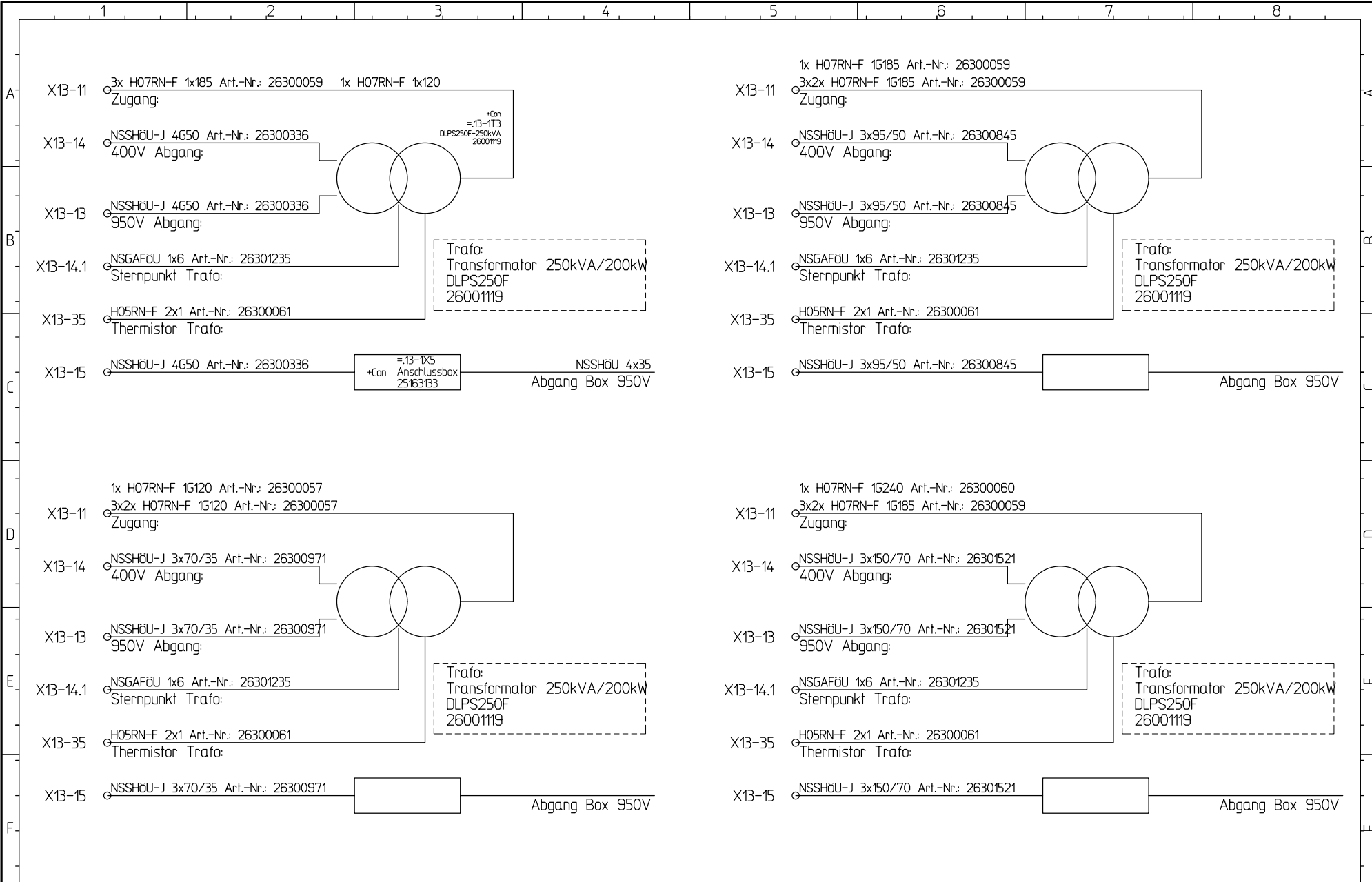

			CAD! KEINE MANUELLEN AENDERUNGEN! CAD! DONT CHANGE MANUAL		Herrenknecht AG Schlehenweg 2 D-77963 Schwanau 2 Tel.: 07824 302-0 Fax: 07824 3403 Info@Herrenknecht.de		Projekt: M-1642-C =Container		Übersicht Trafo Übersicht / general view		Stueckliste: parts list: 25186184		Fg.-Gruppe: funct.-group: .0		Blatt-Nr.: page-nr.: 6			
			Ausdruck-Datum: printout-date: 14.12.11				Zn.-Nr.: drawn-nr.: 3478-562-002-0		Datum: date: 26.08.2011		Bearb.: name: Th		letzte Aenderung: last modification: IB-Revision 14.12.11 Th		Blatt-Global: page-global: 6/166		von from 24	

Patent-, Gebrauchsmuster- oder Geschmacksmuster-Eintragung vorbehalten. of a patent, utility model or design.
 ausdrücklich gestattet. Zuwiderhandlungen verpflichten zu Schadensersatz. Alle Rechte fuer den Fall der authorisation is prohibited. Offenders will be held liable for the payment of damages. All rights reserved in the event of the grant
 Weitergabe sowie Vervielfaeltigung dieses Dokuments, Verwertung und Mitteilung seines Inhalts sind verboten, soweit nicht The reproduction, distribution and utilization of this document as well as the communication of its contents to others without express

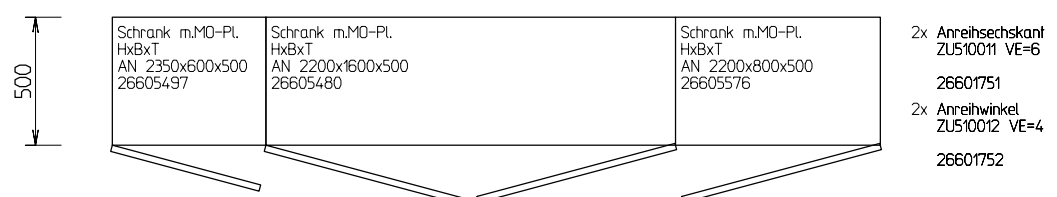
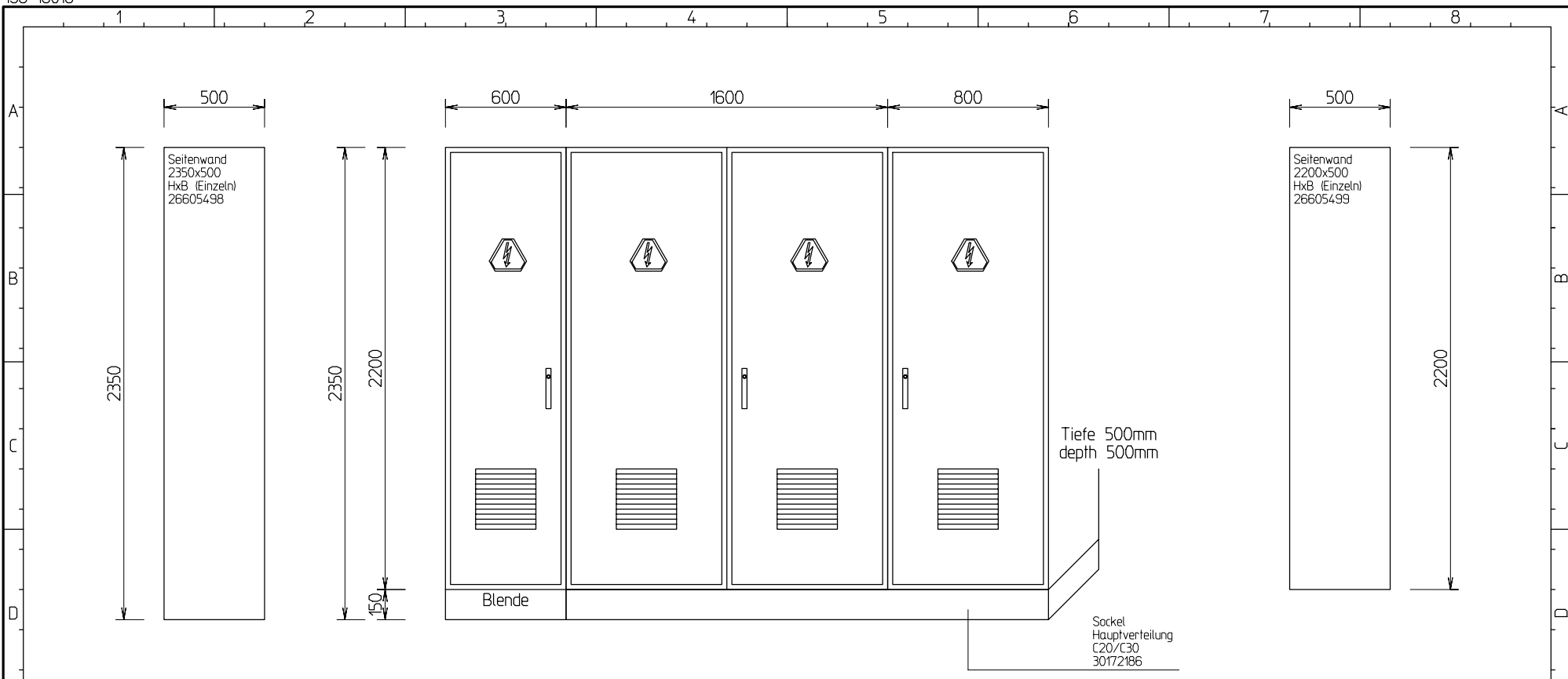

			CAD! KEINE MANUELLEN AENDERUNGEN! CAD! DON'T CHANGE MANUAL		Herrenknecht AG Schlehenweg 2 D-77963 Schwanau 2 Tel.: 07824 302-0 Fax.: 07824 3403 Info@Herrenknecht.de		Projekt: M-1642-C =Container		Schaltschraenke Hauptverteilung cabinet main distribution board Übersicht / general view		Stueckliste: parts list: 25186184		Fg.-Gruppe: funct.-group: .0		Blatt-Nr.: page-nr.: 7					
Index	Aenderung-Nr. Change No.:	Datum / Name date / name	Ausdruck-Datum: printout-date: 14.12.11				Zn.-Nr.: drawn-nr.: 3478-562-002-0		Hauptverteilung main distribution board +HV/MBB		Datum: date: 26.08.2011		Bearb.: name: Th		letzte Aenderung: last modification: IB-Revision 14.12.11 Th		Blatt-Global: page-global: 7/166		von from 24	

Patent-, Gebrauchsmuster- oder Geschmacksmuster-Eintragung vorbehalten.
 of a patent, utility model or design.
 ausdrucklich gestattet. Zuwiderhandlungen verpflichten zu Schadenersatz. Alle Rechte fuer den Fall der Auhorisation is prohibited. Offenders will be held liable for the payment of damages. All rights reserved in the event of the grant
 Weitergabe sowie Vervielfaeltigung dieses Dokuments, Verwertung und Mitteilung seines Inhalts sind verboten, soweit nicht The reproduction, distribution and utilization of this document as well as the communication of its contents to others without express

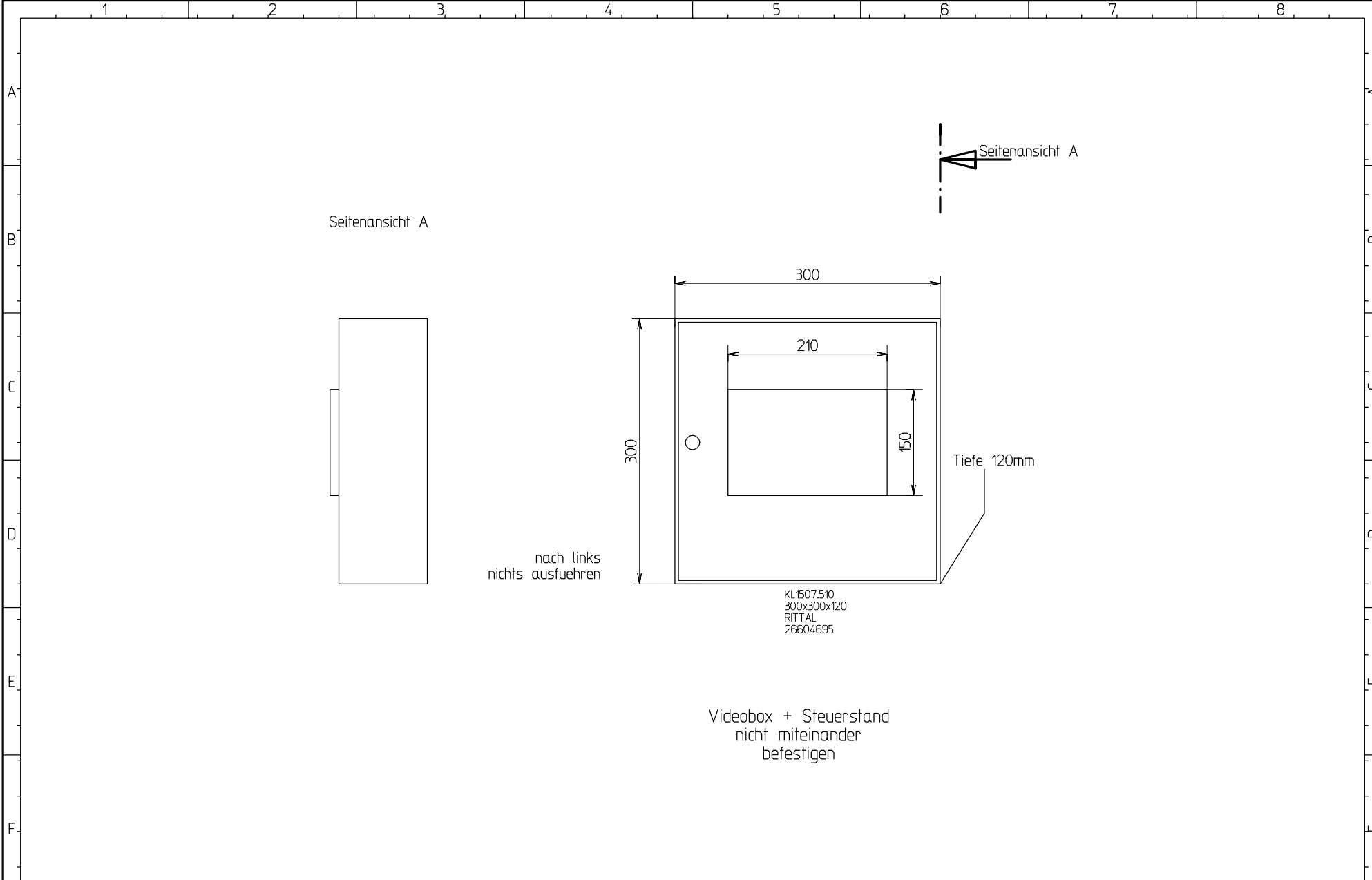

			CAD! KEINE MANUELLEN AENDERUNGEN! CAD! DONT CHANGE MANUAL		Herrenknecht AG Schlehenweg 2 D-77963 Schwanau 2 Tel.: 07824 302-0 Fax.: 07824 3403 Info@Herrenknecht.de		Projekt: M-1642-C =Container		Schaltschrank Videobox Übersicht / general view		Stueckliste: 25186184		Fg.-Gruppe: .0 Blatt-Nr.: 8	
			Ausdruck-Datum: 14.12.11 printout-date:				Zn.-Nr.: 3478-562-002-0 drawn-nr.:		ST-Videobox +ST-VBox		Datum: 26.08.2011 date:		Bearb.: Th name:	
Index Index			Änderung-Nr. Change No.:				Datum / Name date / name				letzte Aenderung: 14.12.11 Th last modification:		Blatt-Global: 8/166 page-global:	

Patent-, Gebrauchsmuster- oder
Geschmacksmuster-Eintragung vorbehalten.
of a patent, utility model or design.

ausdrücklich gestattet. Zuwiderhandlungen verpflichten
zu Schadensersatz. Alle Rechte fuer den Fall der
Auhorisation ist prohibited. Offenders will be held liable for the
payment of damages. All rights reserved in the event of the grant

Weitergabe sowie Vervielfaeltigung dieses Dokuments, Verwertung
und Mitteilung seines Inhalts sind verboten, soweit nicht
The reproduction, distribution and utilization of this document as
well as the communication of its contents to others without express

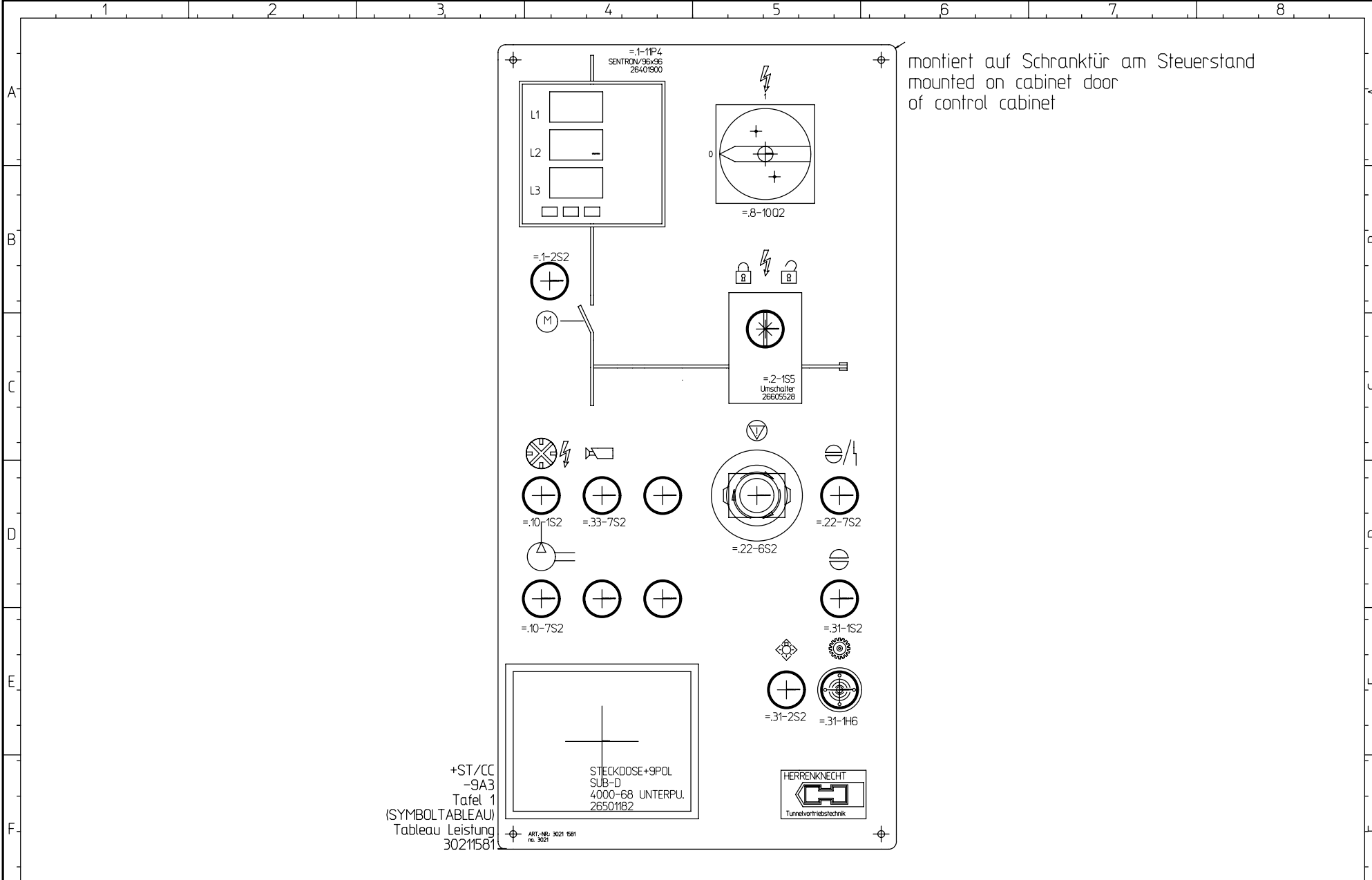

montiert auf Schranktür am Steuerstand
mounted on cabinet door
of control cabinet

			CAD! KEINE MANUELLEN ÄNDERUNGEN! CAD! DONT CHANGE MANUAL	 Herrenknecht AG Schlehenweg 2 D-77963 Schwanau 2 Tel.: 07824 302-0 Fax.: 07824 3403 Info@Herrenknecht.de	Projekt: project: M-1642-C	Tableau Steuerstand Leistung panel control cabin power		Stueckliste: parts list: 25186184	Fg.-Gruppe: funct.-group: .0	Blatt-Nr.: page-nr.: 9
			Ausdruck-Datum: printout-date: 14.12.11		=Container	Übersicht / general view			Blatt-Global: page-global: 9/166	von from 24
Index Index	Änderung-Nr. Change No.:	Datum / Name date / name			Zn.-Nr.: drawn-nr.: 3478-562-002-0	Steuerstand Control Cabin +ST/CC	Datum: date: 26.08.2011	Bearb.: name: Th	letzte Änderung: last modification: 14.12.11	Th

Patent-, Gebrauchsmuster- oder
Geschmacksmuster-Eintragung vorbehalten.
of a patent, utility model or design.

ausdrücklich gestattet. Zuwiderhandlungen verpflichten
zu Schadensersatz. Alle Rechte fuer den Fall der
Auhonisation is prohibited. Offenders will be held liable for the
payment of damages. All rights reserved in the event of the grant

Weitergabe sowie Vervielfaeltigung dieses Dokuments, Verwertung
und Mitteilung seines Inhalts sind verboten, soweit nicht
The reproduction, distribution and utilization of this document as
well as the communication of its contents to others without express

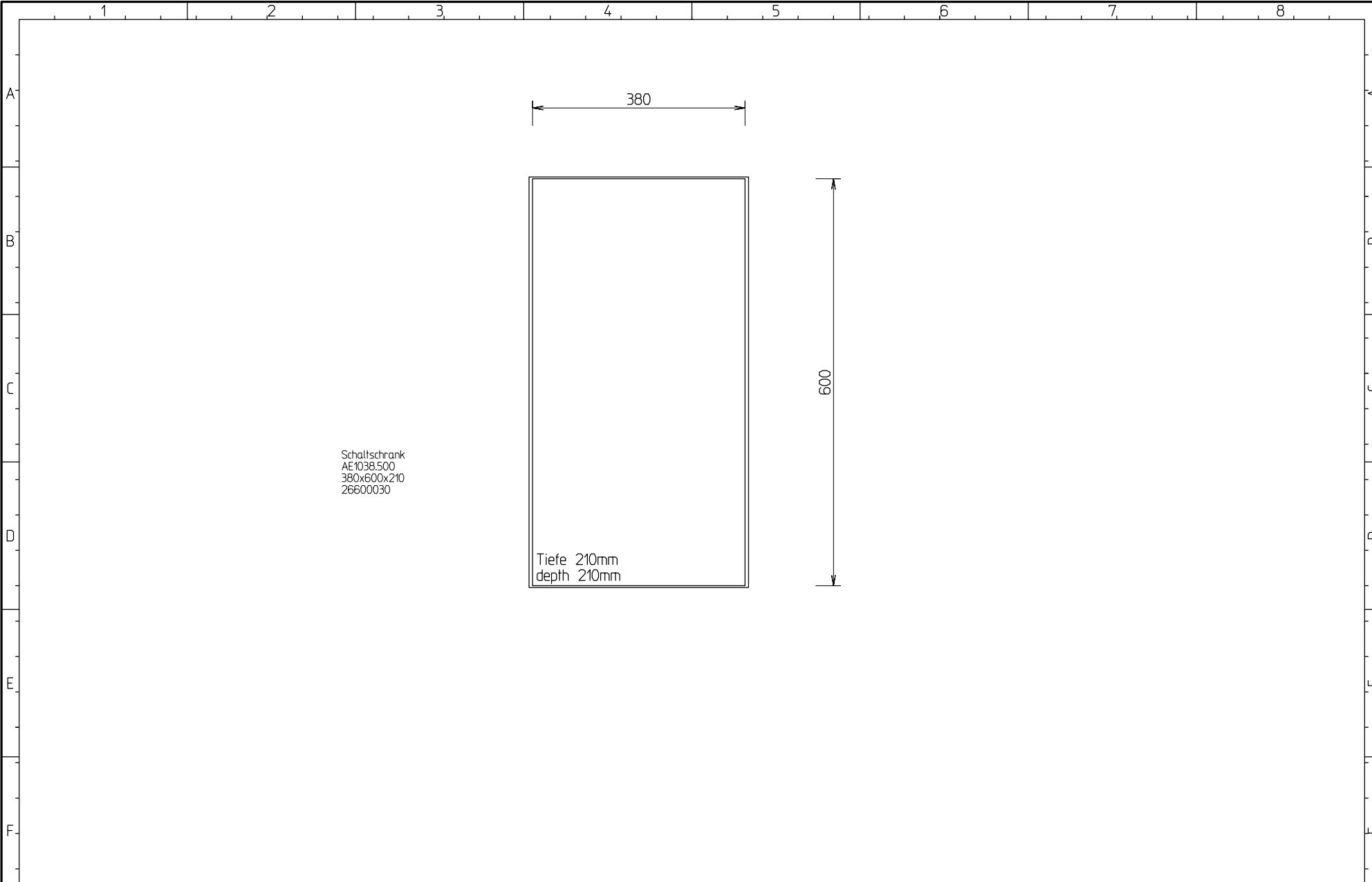

Schaltschrank
AE1038.500
380x600x210
26600030

Tiefe 210mm
depth 210mm

			CAD! KEINE MANUELLEN AENDERUNGEN! CAD! DONT CHANGE MANUAL	 Herrenknecht AG Schlehenweg 2 D-77963 Schwanau 2 Tel.: 07824 302-0 Fax.: 07824 3403 Info@Herrenknecht.de	Projekt: project: M-1642-C	Klemmkasten Steuerstand Leistung		Stueckliste: parts list: 25186184	Fg.-Gruppe: funct.-group: .0	Blatt-Nr.: page-nr.: 10
Index Index	Aenderung-Nr. Change No.:	Datum / Name date / name	Ausdruck-Datum: printout-date: 14.12.11		=Container	Zn.-Nr.: drawn-nr.: 3478-562-002-.0	Steuerstand Control Cabin +ST/CC	Datum: date: 26.08.2011	Bearb.: name: Th	letzte Aenderung: last modification: 10/166

Patent-, Gebrauchsmuster- oder Geschmacksmuster-Eintragung vorbehalten. of a patent, utility model or design.
 ausdrucklich gestattet. Zuwiderhandlungen verpflichten zu Schadenersatz. Alle Rechte fuer den Fall der Auhorisation ist prohibited. Offenders will be held liable for the payment of damages. All rights reserved in the event of the grant
 Weitergabe sowie Vervielfaeltigung dieses Dokuments, Verwertung und Mitteilung seines Inhalts sind verboten, soweit nicht The reproduction, distribution and utilization of this document as well as the communication of its contents to others without express

1	=.34-3X3	26903312	BUCHSE m. Überwurfmutter 2-POLIG	12VDC Laser
2	=.34-4X3	26907064	Gerätedose 6pot+PE	Längenmessung Tunnel / length measuring tunnel

- 1x Blindkappe IP67
26902094
- 4x **wandhalter**
2508.000 SZ
Rittal
26907015
Profibus-Hybrid
16G1,5+2x2x0,25
12m
26302748

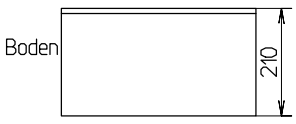
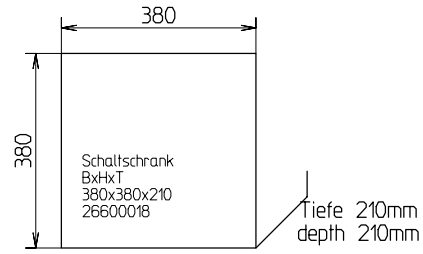

- Türlengehäuse
H-B 24 TSB M25
26905509
- Stifteinsatz B24
26900168
- 4 x **Codierbolzen**
26906294

- 1
- +
- 2
- +

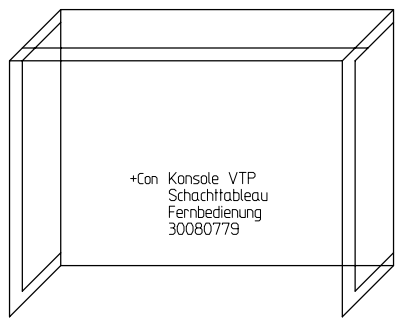

			CAD! KEINE MANUELLEN AENDERUNGEN! CAD! DONT CHANGE MANUAL	 Herrenknecht AG Schlehenweg 2 D-77963 Schwanaau 2 Tel.: 07824 302-0 Fax.: 07824 3403 Info@Herrenknecht.de	Projekt: project: M-1642-C	Schaltschrank Bedienpult Schacht box operation panel shaft		Stueckliste: parts list: 25186184	Fg.-Gruppe: funct.-group: .0	Blatt-Nr.: page-nr.: 11	
Index Index	Aenderung-Nr. Change No.:	Datum / Name date / name	Ausdruck-Datum: printout-date: 14.12.11		=Container	Übersicht / general view	Bedienpult Schacht control panel shaft +BP/CP-S	Datum: date: 26.08.2011	Bearb. name: Th	letzte Aenderung: last modification: 1B-Revision 14.12.11 Th	Blatt-Global: page-global: 11/166

Patent-, Gebrauchsmuster- oder Geschmacksmuster-Eintragung vorbehalten. of a patent, utility model or design.
 ausdrücklich gestattet. Zuwiderhandlungen verpflichten zu Schadensersatz. Alle Rechte fuer den Fall der authorisation is prohibited. Offenders will be held liable for the payment of damages. All rights reserved in the event of the grant
 Weitergabe sowie Vervielfaeltigung dieses Dokuments, Verwertung und Mitteilung seines Inhalts sind verboten, soweit nicht The reproduction, distribution and utilization of this document as well as the communication of its contents to others without express

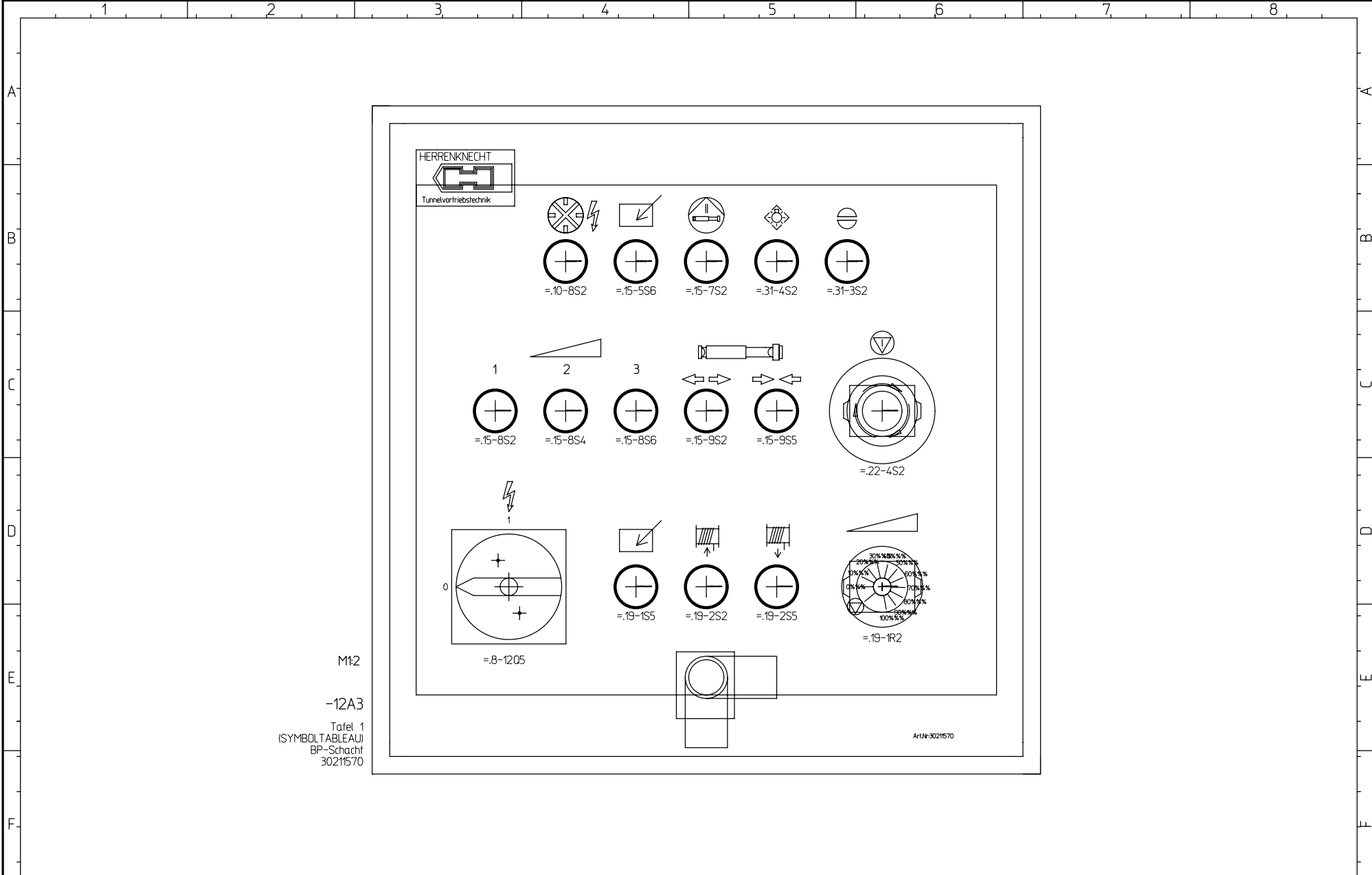

			CAD! KEINE MANUELLEN AENDERUNGEN! CAD! DONT CHANGE MANUAL		Herrenknecht AG Schlehenweg 2 D-77963 Schwanaau 2 Tel.: 07824 302-0 Fax.: 07824 3403 Info@Herrenknecht.de		Projekt: M-1642-C =Container		Bedienpult Schacht control panel shaft Übersicht / general view		Stueckliste: parts list: 25186184		Fg.-Gruppe: funct.-group: .0		Blatt-Nr.: page-nr.: 12					
Index	Aenderung-Nr. Change No.:	Datum / Name date / name	Ausdruck-Datum: printout-date: 14.12.11				Zn.-Nr.: drawn-nr.: 3478-562-002-0		Bedienpult Schacht control panel shaft +BP/CP-S		Datum: date: 26.08.2011		Bearb.: name: Th		letzte Aenderung: last modification: IB-Revision 14.12.11 Th		Blatt-Global: page-global: 12/166		von from 24	

Patent-, Gebrauchsmuster- oder Geschmacksmuster-Eintragung vorbehalten.
 of a patent, utility model or design.
 ausdrucklich gestattet. Zuwiderhandlungen verpflichten zu Schadenersatz. Alle Rechte fuer den Fall der Auhonanzation is prohibited. Offenders will be held liable for the payment of damages. All rights reserved in the event of the grant
 ausdrucklich gestattet. Zuwiderhandlungen verpflichten zu Schadenersatz. Alle Rechte fuer den Fall der Auhonanzation is prohibited. Offenders will be held liable for the payment of damages. All rights reserved in the event of the grant
 Weitergabe sowie Vervielfaeltigung dieses Dokuments, Verwertung und Mitteilung seines Inhalts sind verboten, soweit nicht The reproduction, distribution and utilization of this document as well as the communication of its contents to others without express

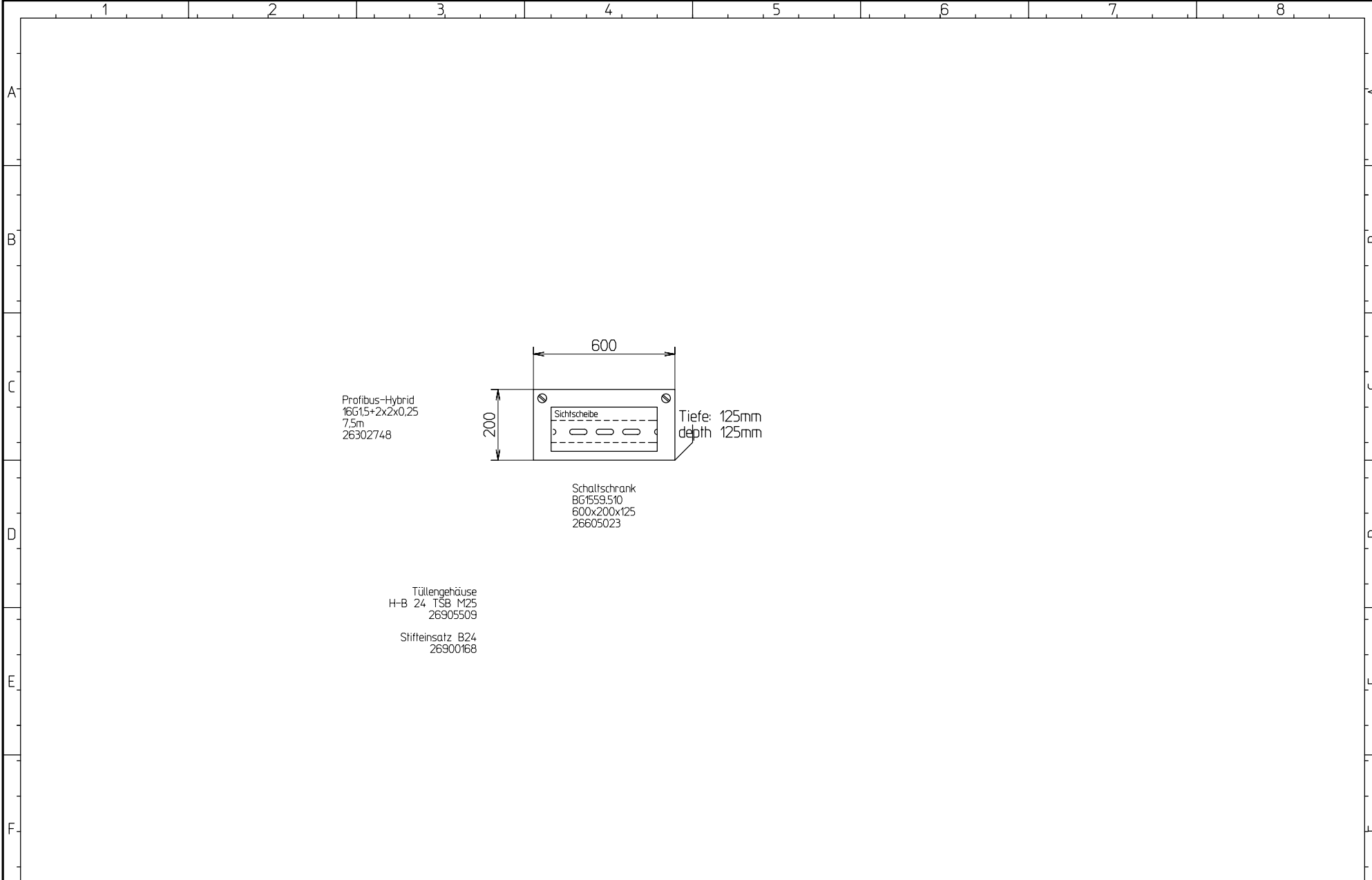



			CAD! KEINE MANUELLEN AENDERUNGEN! CAD! DONT CHANGE MANUAL		 Herrenknecht AG Schlehenweg 2 D-77963 Schwanau 2 Tel.: 07824 302-0 Fax.: 07824 3403 Info@Herrenknecht.de	Projekt: M-1642-C =Container		XD40 Aggregat XD40 aggregate Übersicht / general view		Stueckliste: 25186184		Fg.-Gruppe: .0 Blatt-Nr.: 13		
Ausdruck-Datum: 14.12.11 printout-date:						Zn.-Nr.: 3478-562-002-0 drawn-nr.:		Aggregatedose XD40 +AGG_XD40		Datum: 26.08.2011 date:		Bearb.: Th name:		letzte Aenderung: 14.12.11 Th last modification:

Patent-, Gebrauchsmuster- oder
Geschmacksmuster-Eintragung vorbehalten.
of a patent, utility model or design.

ausdrücklich gestattet. Zuwiderhandlungen verpflichten
zu Schadensersatz. Alle Rechte fuer den Fall der
Autorisation ist prohibited. Offenders will be held liable for the
payment of damages. All rights reserved in the event of the grant

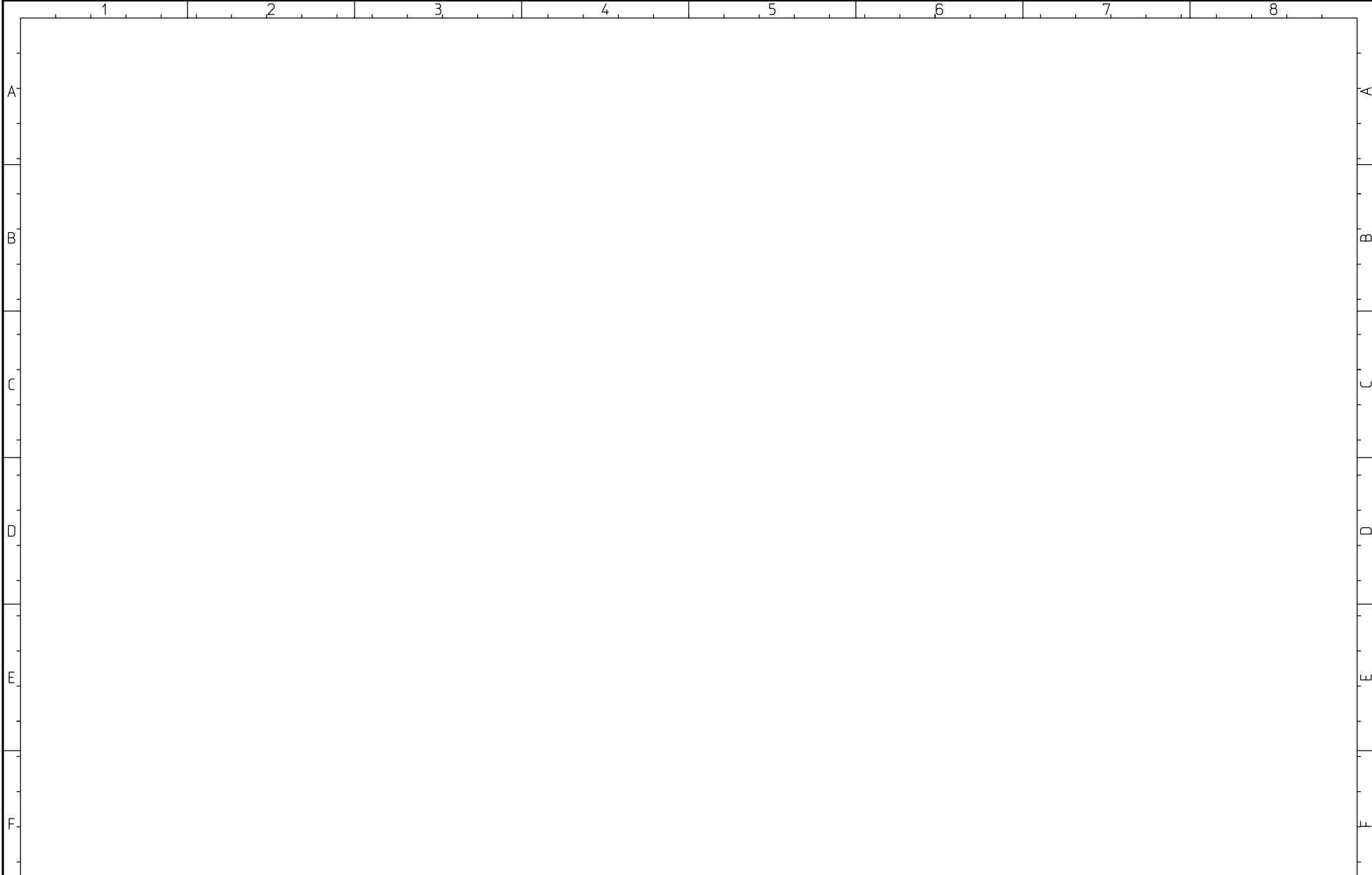
Weitergabe sowie Vervielfaeltigung dieses Dokuments, Verwertung
und Mitteilung seines Inhalts sind verboten, soweit nicht
The reproduction, distribution and utilization of this document as
well as the communication of its contents to others without express



			CAD! KEINE MANUELLEN AENDERUNGEN ! CAD! DONT CHANGE MANUAL	 Herrenknecht AG Schlehenweg 2 D-77963 Schwanau 2 Tel.: 07824 302-0 Fax.: 07824 3403 Info@Herrenknecht.de	Projekt: project: M-1642-C	Reserve reserve	Stueckliste: parts list: 25186184	Fg.-Gruppe: funct.-group: .0	Blatt-Nr.: page-nr.: 14	
Index Index	Aenderung-Nr. Change No.:	Datum / Name date / name	Ausdruck-Datum: printout-date: 14.12.11		=Container	Zn.-Nr.: drawn-nr.: 3478-562-002-0	Datum: date: 26.08.2011	Bearb.: name: Th	letzte Aenderung: last modification: 14.12.11 Th	Blatt-Global: page-global: 14/166

Weitergabe sowie Vervielfältigung dieses Dokuments, Verwertung und Mitteilung seines Inhalts sind verboten, soweit nicht ausdrücklich gestattet. Zuwiderhandlungen verpflichten zu Schadensersatz. Alle Rechte für den Fall der Autorisation ist vorbehalten. Offenders will be held liable for the payment of damages. All rights reserved in the event of the grant of a patent, utility model or design.

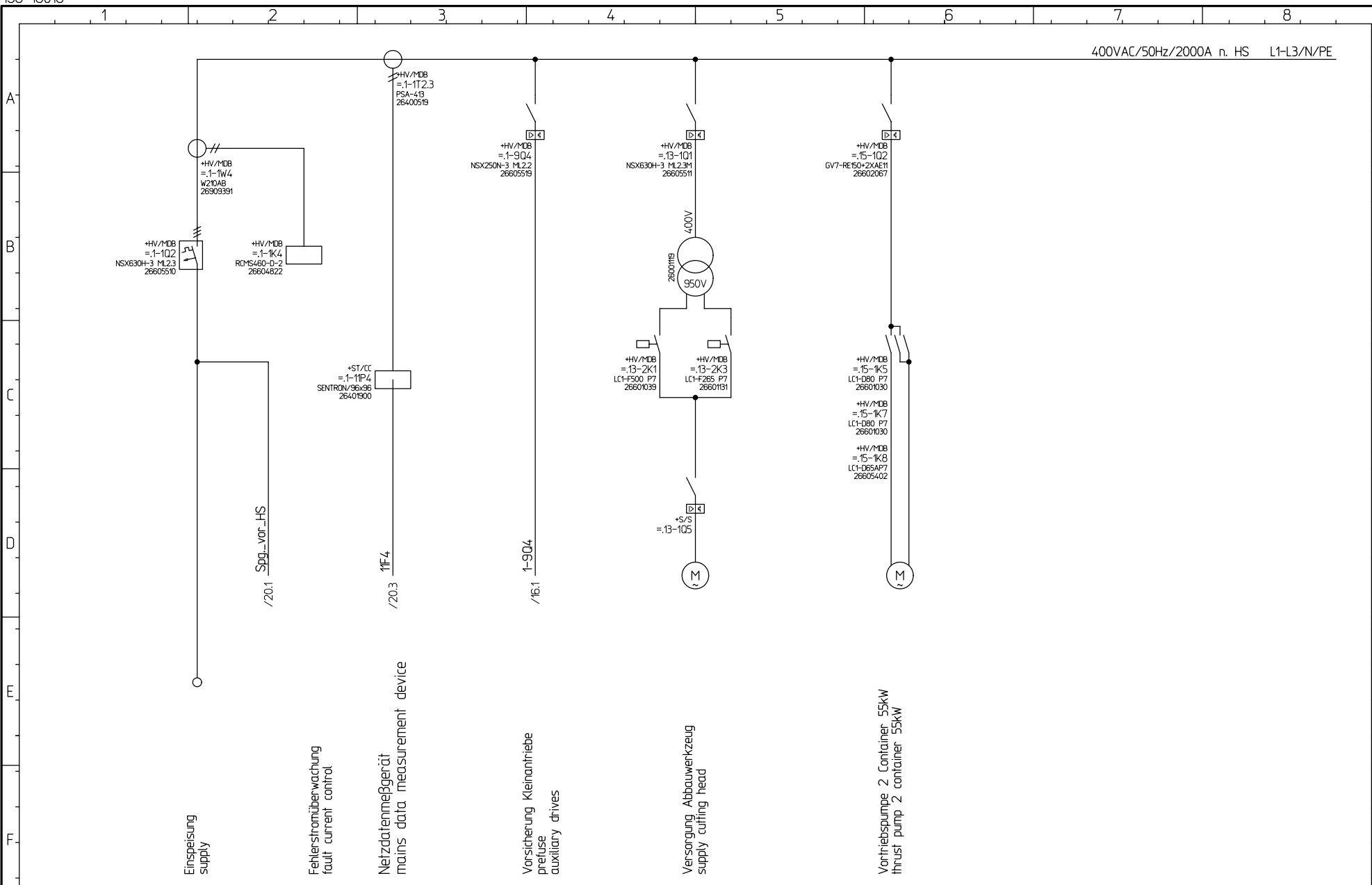

Einspeisung
supply

Fehlerstromüberwachung
fault current control

Netzdatenmeßgerät
mains data measurement device

Vorsicherung Kleinantriebe
prefuse
auxiliary drives

Versorgung Abbaugerät
supply cutting head

Vartriebspumpe 2 Container 55kW
thrust pump 2 container 55kW

Index		Änderung-Nr. Change No.:		Datum / Name date / name		CAD! KEINE MANUELLEN ÄNDERUNGEN! CAD! DONT CHANGE MANUAL		 Herrenknecht AG Schlehenweg 2 D-77963 Schwanau 2 Tel.: 07824 302-0 Fax.: 07824 3403 Info@Herrenknecht.de	Projekt: project: M-1642-C		1-polige Darstellung single line view		Stueckliste: parts list: 25186184		Fg.-Gruppe: funct.-group: .0		Blatt-Nr.: page-nr.: 15				
Index		Änderung-Nr. Change No.:		Datum / Name date / name		Ausdruck-Datum: printout-date: 14.12.11			Zn.-Nr.: drawn-nr.: 3478-562-002-0		Übersicht / general view		Datum: date: 26.08.2011		Bearb.: name: Th		letzte Änderung: last modification: 14.12.11 Th		Blatt-Global: page-global: 15/166		von from 24

Patent-, Gebrauchsmuster- oder Geschmacksmuster-Eintragung vorbehalten.
of a patent, utility model or design.

ausdrücklich gestattet. Zuwiderhandlungen verpflichten zu Schadenersatz. Alle Rechte für den Fall der Autorisation ist prohibited. Offenders will be liable for the payment of damages. All rights reserved in the event of the grant

Weitergabe sowie Vervielfältigung dieses Dokuments, Verwertung und Mitteilung seines Inhalts sind verboten, soweit nicht ausdrücklich gestattet. Zuwiderhandlungen verpflichten zu Schadenersatz. Alle Rechte für den Fall der Autorisation ist prohibited. Offenders will be liable for the payment of damages. All rights reserved in the event of the grant

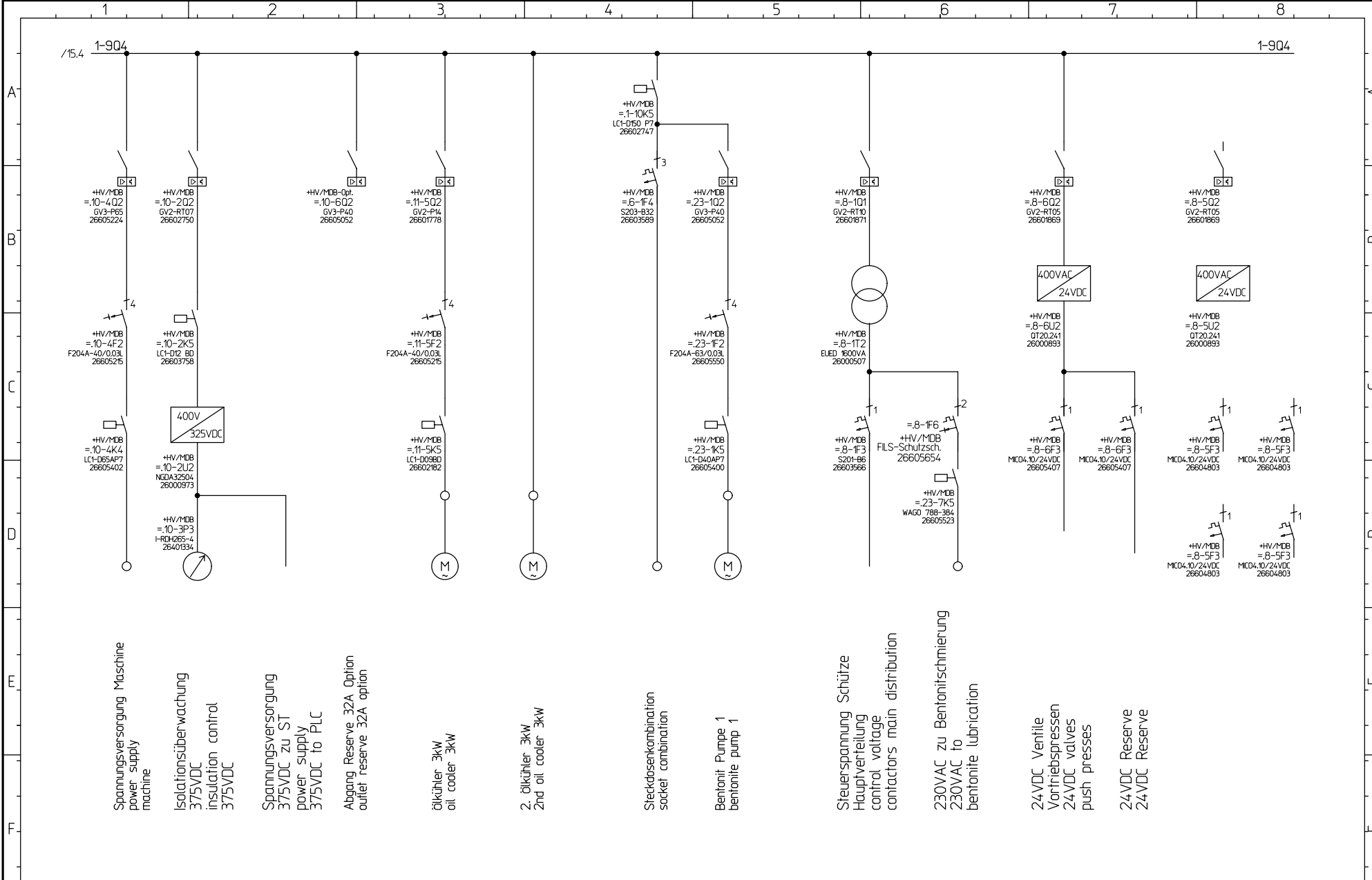

Spannungsversorgung Maschine
power supply machine

Isolationsüberwachung
375VDC
insulation control
375VDC

Spannungsversorgung
375VDC zu ST
power supply
375VDC to PLC

Abgang Reserve 32A Option
outlet reserve 32A option

Ölkühler 3kW
oil cooler 3kW

2. Ölkühler 3kW
2nd oil cooler 3kW

Steckdosenkombination
socket combination

Bentoni Pumpe 1
Bentonite pump 1

Steuerspannung Schütze
Hauptverteilung
control voltage
contactors main distribution

230VAC zu Bentonitschmierung
230VAC to
Bentonite lubrication

24VDC Ventile
Ventiltriebspresen
24VDC valves
push presses

24VDC Reserve
24VDC Reserve

Index		Änderung-Nr. Change No.:		Datum / Name date / name		CAD! KEINE MANUELLEN ÄNDERUNGEN! CAD! DONT CHANGE MANUAL		 Herrenknecht AG Schlehenweg 2 D-77963 Schwanau 2 Tel.: 07824 302-0 Fax.: 07824 3403 Info@Herrenknecht.de	Projekt: project: M-1642-C		1-polige Darstellung single line view		Stueckliste: parts list: 25186184		Fg.-Gruppe: func.-group: .0		Blatt-Nr.: page-nr.: 16				
Index		Änderung-Nr. Change No.:		Datum / Name date / name		Ausdruck-Datum: printout-date: 14.12.11			Zn.-Nr.: drawn-nr.: 3478-562-002-0		Übersicht / general view		Datum: date: 26.08.2011		Bearb.: name: Th		letzte Änderung: last modification: IB-Revision 14.12.11 Th		Blatt-Global: page-global: 16/166		von from 24

Patent-, Gebrauchsmuster- oder
Geschmacksmuster-Eintragung vorbehalten.
of a patent, utility model or design.

ausdrücklich gestattet. Zuwiderhandlungen verpflichten
zu Schadensersatz. Alle Rechte fuer den Fall der
Auhonization is prohibited. Offenders will be held liable for the
payment of damages. All rights reserved in the event of the grant

Weitergabe sowie Vervielfaeltigung dieses Dokuments, Verwertung
und Mitteilung seines Inhalts sind verboten, soweit nicht
The reproduction, distribution and utilization of this document as
well as the communication of its contents to others without express

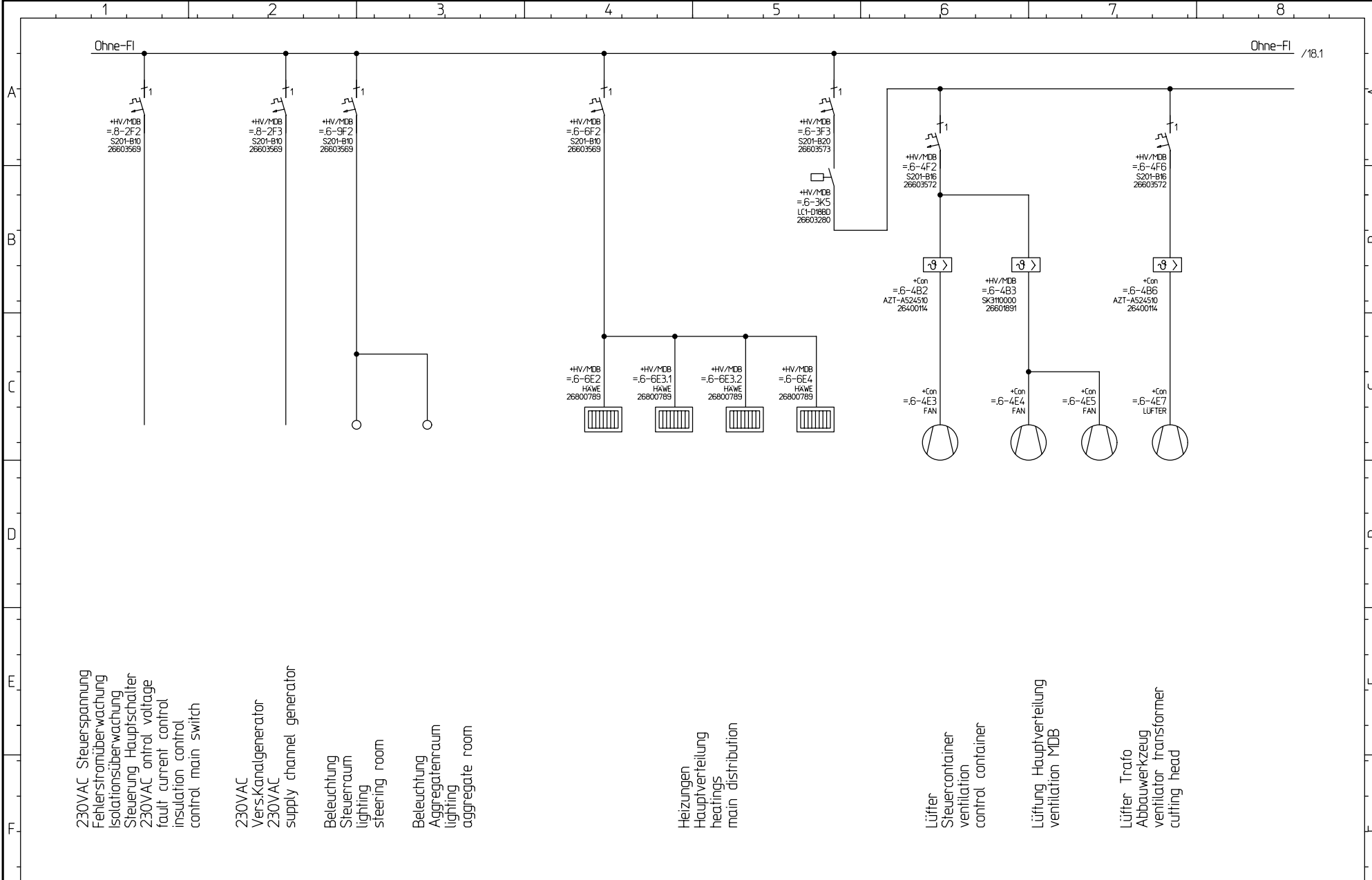

230VAC Steuer- und Fehlerstromüberwachung
230VAC Isolationsüberwachung
230VAC onrtol voltage
fault current control
insulation control
control main switch

230VAC
Vers.Kanalgenerator
230VAC
supply channel generator

Beleuchtung
Steerraum
lighting
steering room

Beleuchtung
Aggregatenraum
lighting
aggregate room

Heizungen
Hauptverteilung
heatings
main distribution

Lüfter
Steuercontainer
ventilation
control container

Lüftung Hauptverteilung
ventilation MDB

Lüfter Trfo
Abbauwerkzeug
ventilator transformer
cutting head

Index		Änderung-Nr. Change No.:		Datum / Name date / name		CAD! KEINE MANUELLEN ÄNDERUNGEN! CAD! DONT CHANGE MANUAL		 Herrenknecht AG Schlehenweg 2 D-77963 Schwanaau 2 Tel.: 07824 302-0 Fax.: 07824 3403 Info@Herrenknecht.de	Projekt: project: M-1642-C		1-polige Darstellung single line view		Stueckliste: parts list: 25186184		Fg.-Gruppe: funct.-group: .0		Blatt-Nr.: page-nr.: 17				
Index		Änderung-Nr. Change No.:		Datum / Name date / name		Ausdruck-Datum: printout-date: 14.12.11			Zn.-Nr.: drawn-nr.: 3478-562-002-0		Übersicht / general view		Datum: date: 26.08.2011		Bearb.: name: Th		letzte Aenderung: last modification: IB-Revision 14.12.11 Th		Blatt-Global: page-global: 17/166		von from 24

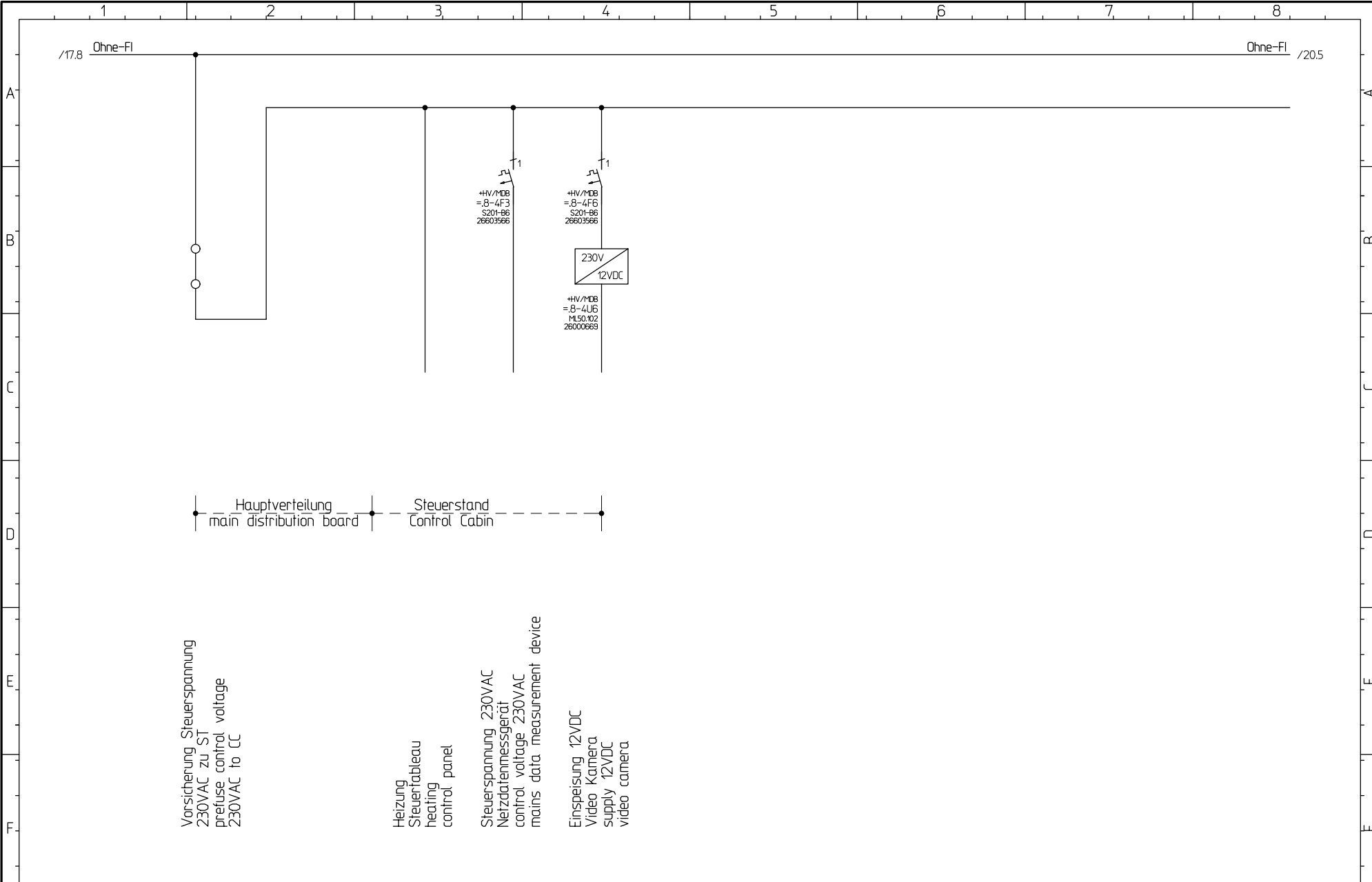

Patent-, Gebrauchsmuster- oder Geschmacksmuster-Eintragung vorbehalten. of a patent, utility model or design.
 ausdrücklich gestattet. Zuwiderhandlungen verpflichten zu Schadensersatz. Alle Rechte fuer den Fall der authorisation is prohibited. Offenders will be held liable for the payment of damages. All rights reserved in the event of the grant
 Weitergabe sowie Vervielfaeltigung dieses Dokuments, Verwertung und Mitteilung seines Inhalts sind verboten, soweit nicht The reproduction, distribution and utilization of this document as well as the communication of its contents to others without express

Vorsicherung Steuerspannung
230VAC zu ST
prefuse control voltage
230VAC to CC

Heizung
Steuerbleau
heating
control panel

Steuerspannung 230VAC
Netzdatenmessgeraet
control voltage 230VAC
mains data measurement device

Einspeisung 12VDC
Video Kamera
supply 12VDC
video camera

Hauptverteilung main distribution board
Steuerstand Control Cabin

CAD! KEINE MANUELLEN AENDERUNGEN ! CAD! DONT CHANGE MANUAL			 Herrenknecht AG Schlehenweg 2 D-77963 Schwanau 2 Tel.: 07824 302-0 Fax.: 07824 3403 Info@Herrenknecht.de	Projekt: M-1642-C =Container		1-polige Darstellung single line view Übersicht / general view		Stueckliste: parts list: 25186184		Fg.-Gruppe: funct.-group: .0		Blatt-Nr.: page-nr.: 18		
Ausdruck-Datum: printout-date: 14.12.11				Zn.-Nr.: drawn-nr.: 3478-562-002-0		Datum: date: 26.08.2011		Bearb.: name: Th		letzte Aenderung: last modification: IB-Revision 14.12.11 Th		Blatt-Global: page-global: 18/166		von from 24

Patent-, Gebrauchsmuster- oder
Geschmacksmuster-Eintragung vorbehalten.
of a patent, utility model or design.

ausdrücklich gestattet. Zuwiderhandlungen verpflichten
zu Schadenssz. Alle Rechte fuer den Fall der
Autorisation is prohibited. Offenders will be held liable for the
payment of damages. All rights reserved in the event of the grant

Weitergabe sowie Vervielfaeltigung dieses Dokuments, Verwertung
und Mitteilung seines Inhalts sind verboten, soweit nicht
The reproduction, distribution and utilization of this document as
well as the communication of its contents to others without express

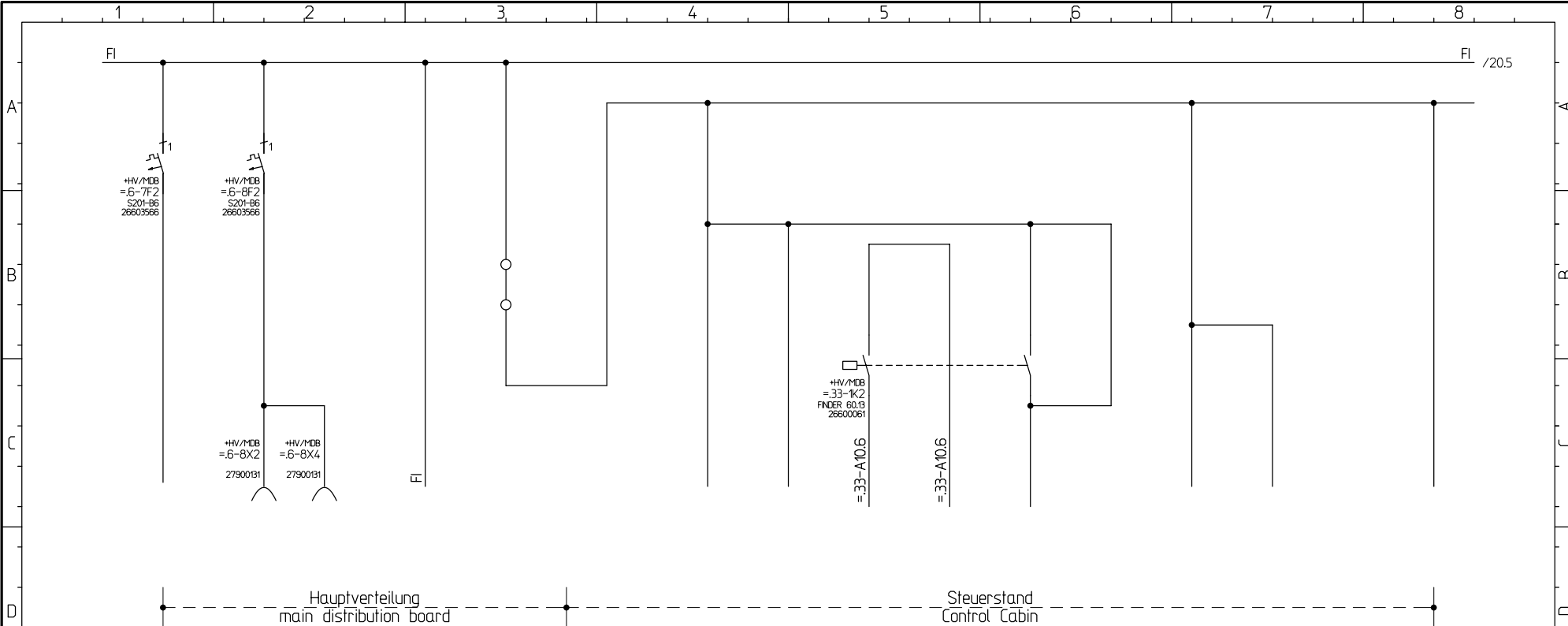

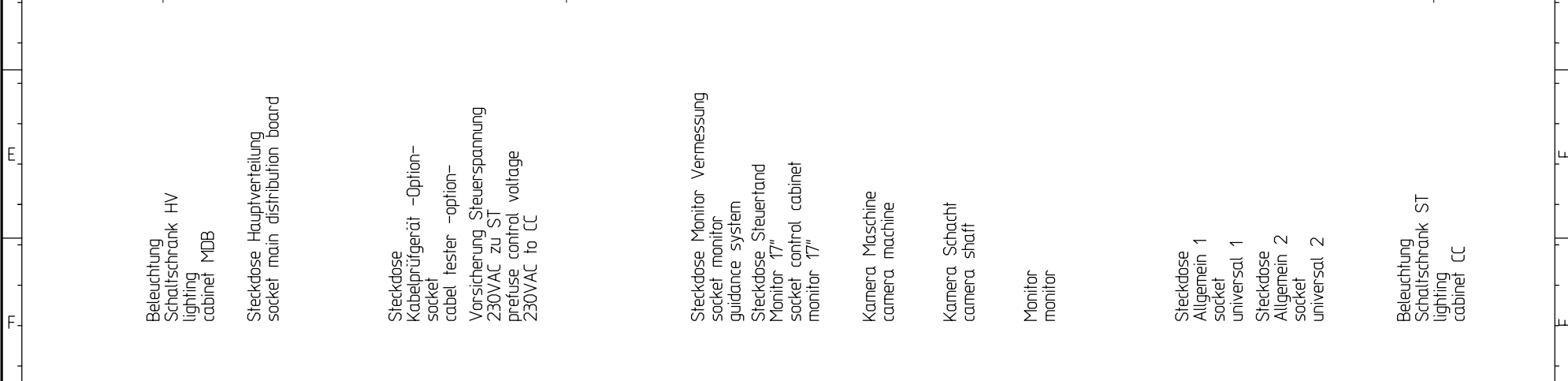

1 2 3 4 5 6 7 8

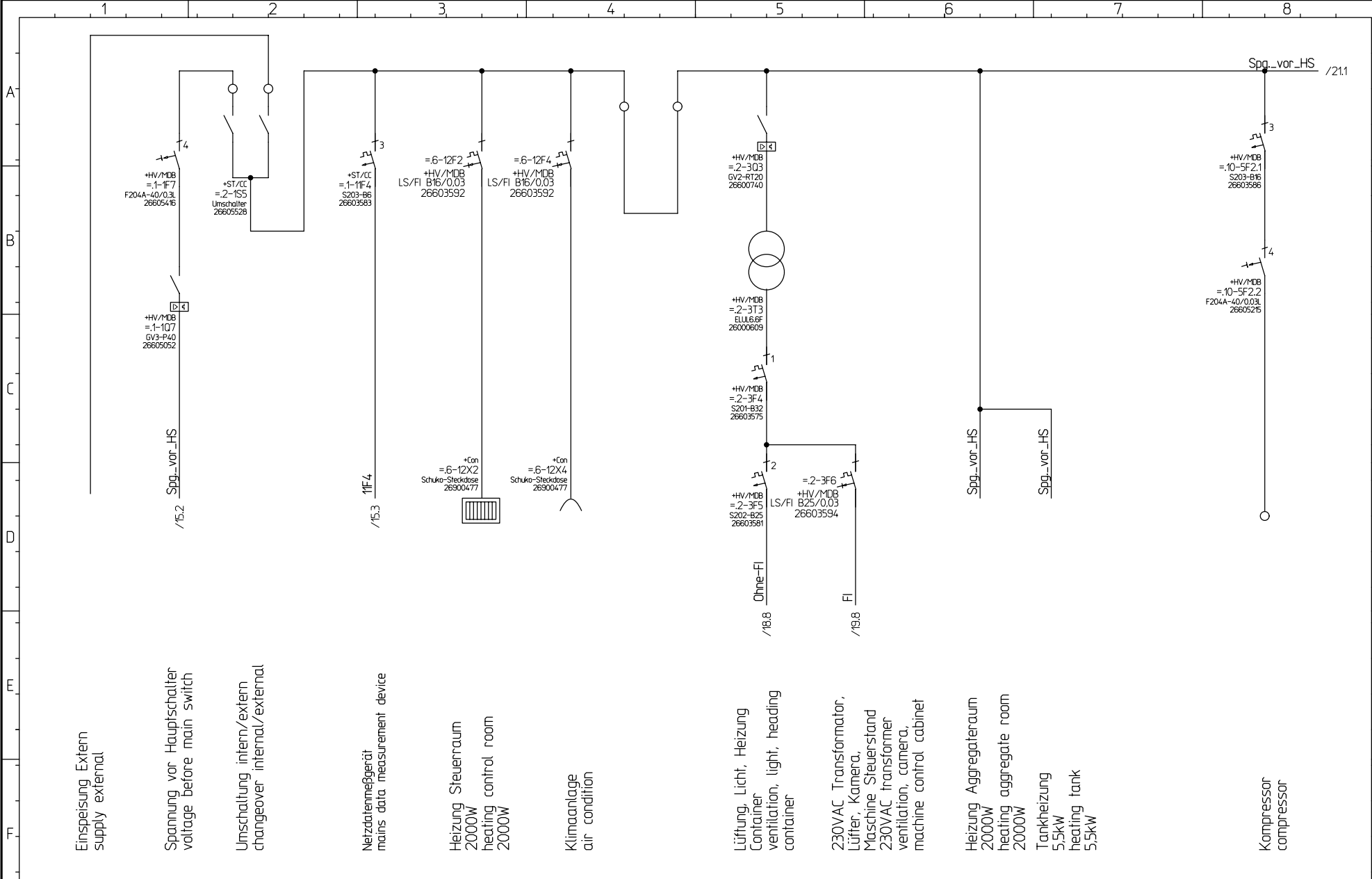

Index		Änderung-Nr. Change No.:		Datum / Name date / name		CAD! KEINE MANUELLEN ÄNDERUNGEN! CAD! DONT CHANGE MANUAL		 Herrenknecht AG Schlehenweg 2 D-77963 Schwanau 2 Tel.: 07824 302-0 Fax.: 07824 3403 Info@Herrenknecht.de		Projekt: project: M-1642-C		1-polige Darstellung single line view		Stueckliste: parts list: 25186184		Fg.-Gruppe: func.-group: .0		Blatt-Nr.: page-nr.: 19			
Index		Änderung-Nr. Change No.:		Datum / Name date / name		Ausdruck-Datum: printout-date: 14.12.11				Zn.-Nr.: drawn-nr.: 3478-562-002-0		Datum: date: 26.08.2011		Bearb.: name: Th		letzte Aenderung: last modification: 14.12.11 Th		Blatt-Global: page-global: 19/166		von from 24	

Patent-, Gebrauchsmuster- oder Geschmacksmuster-Eintragung vorbehalten. of a patent, utility model or design.
 ausdrucklich gestattet. Zuwiderhandlungen verpflichten zu Schadensersatz. Alle Rechte fuer den Fall der authorization is prohibited. Offenders will be held liable for the payment of damages. All rights reserved in the event of the grant
 Weitergabe sowie Vervielfaeltigung dieses Dokuments, Verwertung und Mitteilung seines Inhalts sind verboten, soweit nicht The reproduction, distribution and utilization of this document as well as the communication of its contents to others without express



			CAD! KEINE MANUELLEN AENDERUNGEN! CAD! DONT CHANGE MANUAL		Herrenknecht AG Schlehenweg 2 D-77963 Schwanau 2 Tel.: 07824 302-0 Fax.: 07824 3403 Info@Herrenknecht.de		Projekt: project: M-1642-C		1-polige Darstellung single line view Übersicht / general view		Stueckliste: parts list: 25186184		Fg.-Gruppe: funct.-group: .0		Blatt-Nr.: page-nr.: 20			
			Ausdruck-Datum: printout-date: 14.12.11				Zn.-Nr.: drawn-nr.: 3478-562-002-0		Datum: date: 26.08.2011		Bearb.: name: Th		letzte Aenderung: last modification: IB-Revision 14.12.11 Th		Blatt-Global: page-global: 20/166		von from 24	

Patent-, Gebrauchsmuster- oder Geschmacksmuster-Eintragung vorbehalten.
 of a patent, utility model or design.
 ausdrucklich gestattet. Zuwiderhandlungen verpflichten zu Schadensersatz. Alle Rechte fuer den Fall der authorisation is prohibited. Offenders will be held liable for the payment of damages. All rights reserved in the event of the grant
 Weitergabe sowie Vervielfaeltigung dieses Dokuments, Verwertung und Mitteilung seines Inhalts sind verboten, soweit nicht The reproduction, distribution and utilization of this document as well as the communication of its contents to others without express

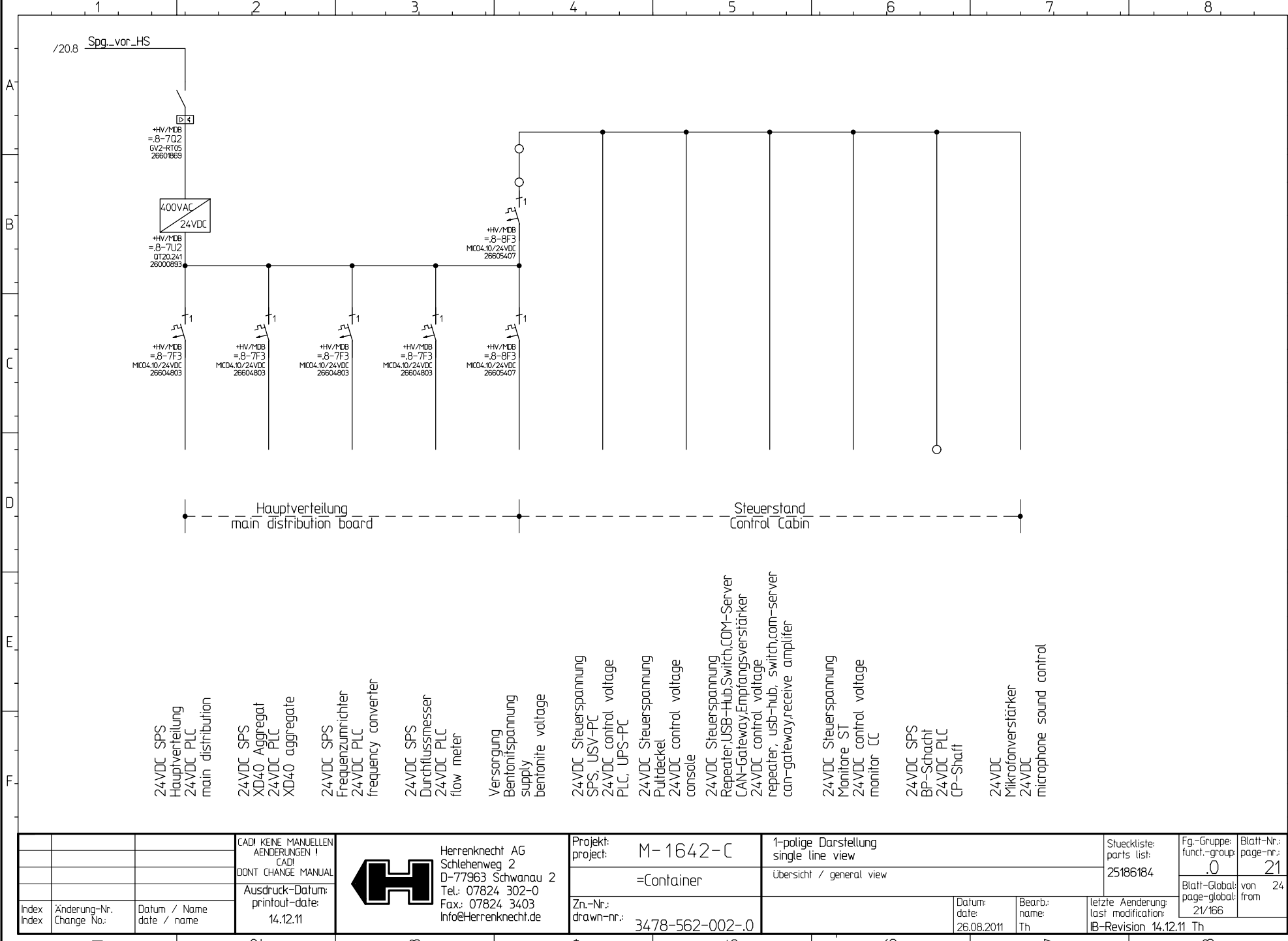



Index		Änderung-Nr. / Change No.:		Datum / Name / date / name		CAD! KEINE MANUELLEN ÄNDERUNGEN! CAD! DONT CHANGE MANUAL		 Herrenknecht AG Schlehenweg 2 D-77963 Schwanau 2 Tel.: 07824 302-0 Fax.: 07824 3403 Info@Herrenknecht.de		Projekt: M-1642-C =Container Projekt: M-1642-C =Container		1-polige Darstellung single line view Übersicht / general view		Stueckliste: parts list: 25186184		Fg.-Gruppe: funct.-group: .0		Blatt-Nr.: page-nr.: 21			
Index		Änderung-Nr. / Change No.:		Datum / Name / date / name		Ausdruck-Datum: printout-date: 14.12.11				Zn.-Nr.: drawn-nr.: 3478-562-002-0		Datum: date: 26.08.2011		Bearb.: name: Th		letzte Aenderung: last modification: IB-Revision 14.12.11 Th		Blatt-Global: page-global: 21/166		von from 24	

Patent-, Gebrauchsmuster- oder
Geschmacksmuster-Eintragung vorbehalten.
of a patent, utility model or design.

ausdrücklich gestattet. Zuwiderhandlungen verpflichten
zu Schadensersatz. Alle Rechte fuer den Fall der
Auhorisation is prohibited. Offenders will be held liable for the
payment of damages. All rights reserved in the event of the grant

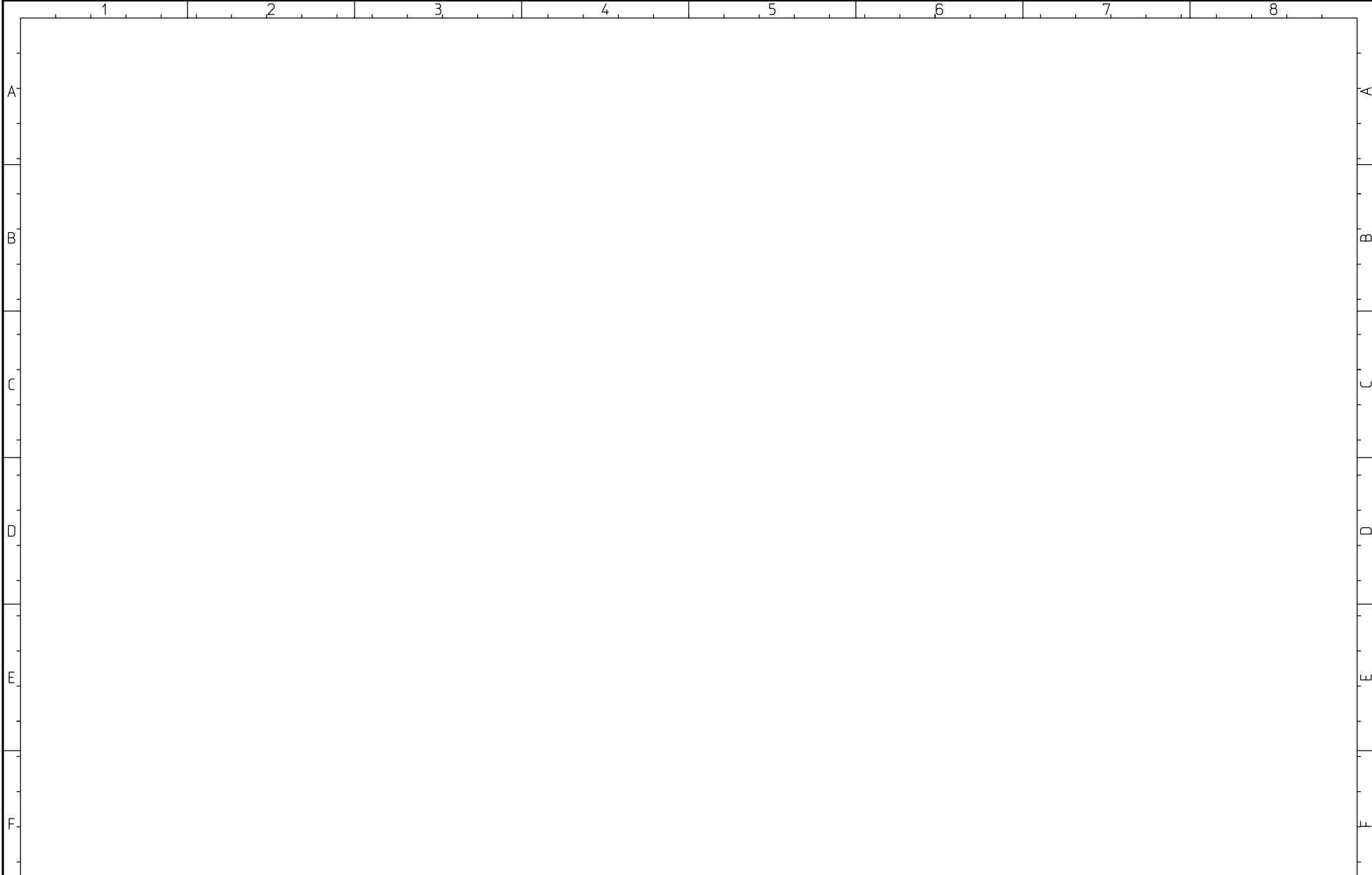
Weitergabe sowie Vervielfaeltigung dieses Dokuments, Verwertung
und Mitteilung seines Inhalts sind verboten, soweit nicht
The reproduction, distribution and utilization of this document as
well as the communication of its contents to others without express



			CAD! KEINE MANUELLEN AENDERUNGEN ! CAD! DONT CHANGE MANUAL	 Herrenknecht AG Schlehenweg 2 D-77963 Schwanau 2 Tel.: 07824 302-0 Fax.: 07824 3403 Info@Herrenknecht.de	Projekt: project: M-1642-C	Reserve reserve	Stueckliste: parts list: 25186184	Fg.-Gruppe: funct.-group: .0	Blatt-Nr.: page-nr.: 22	
Index Index	Aenderung-Nr. Change No.:	Datum / Name date / name	Ausdruck-Datum: printout-date: 14.12.11		=Container	Zn.-Nr.: drawn-nr.: 3478-562-002-0	Datum: date: 26.08.2011	Bearb.: name: Th	letzte Aenderung: last modification: 14.12.11 Th	Blatt-Global: page-global: 22/166

Patent-, Gebrauchsmuster- oder Geschmacksmuster-Eintragung vorbehalten.
 of a patent, utility model or design.
 ausdrücklich gestattet. Zuwiderhandlungen verpflichten zu Schadensersatz. Alle Rechte fuer den Fall der Autorisation ist prohibited. Offenders will be held liable for the payment of damages. All rights reserved in the event of the grant
 Weitergabe sowie Vervielfaeltigung dieses Dokuments, Verwertung und Mitteilung seines Inhalts sind verboten, soweit nicht The reproduction, distribution and utilization of this document as well as the communication of its contents to others without express

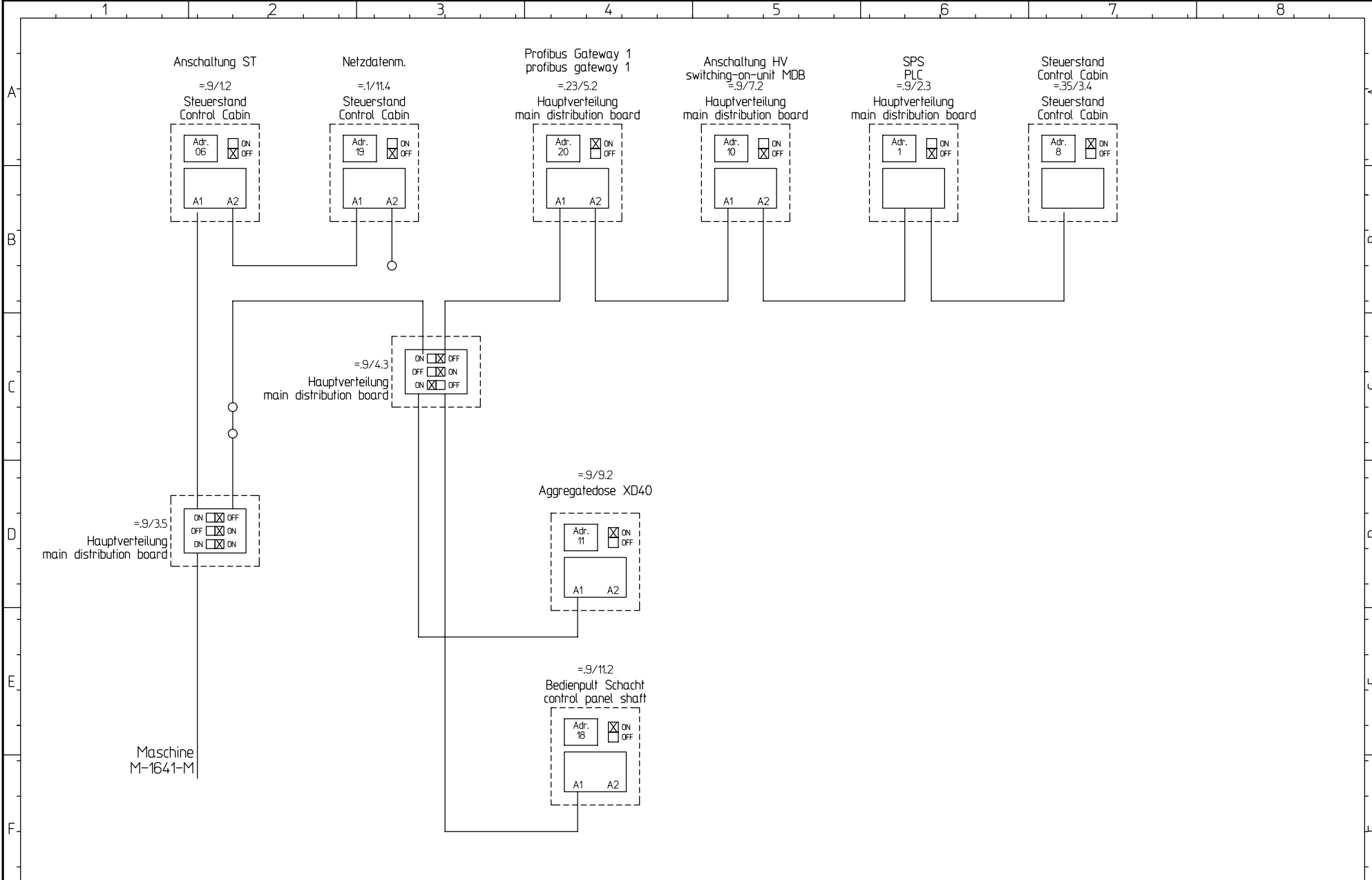



			CAD! KEINE MANUELLEN AENDERUNGEN! CAD! DONT CHANGE MANUAL		 Herrenknecht AG Schlehenweg 2 D-77963 Schwanau 2 Tel.: 07824 302-0 Fax.: 07824 3403 Info@Herrenknecht.de	Projekt: M-1642-C =Container		Busübersicht bus overview Übersicht / general view		Stueckliste: parts list: 25186184		Fg.-Gruppe: funct.-group: .0		Blatt-Nr.: page-nr.: 23		
			Ausdruck-Datum: printout-date: 14.12.11			Zn.-Nr.: drawn-nr.: 3478-562-002-0		Datum: date: 26.08.2011		Bearb.: name: Th		letzte Aenderung: last modification: IB-Revision 14.12.11 Th		Blatt-Global: page-global: 23/166		von from 24

Patent-, Gebrauchsmuster- oder Geschmacksmuster-Eintragung vorbehalten.
 of a patent, utility model or design.

ausdrücklich gestattet. Zuwiderhandlungen verpflichten zu Schadensersatz. Alle Rechte fuer den Fall der Autorisation ist prohibited. Offenders will be held liable for the payment of damages. All rights reserved in the event of the grant

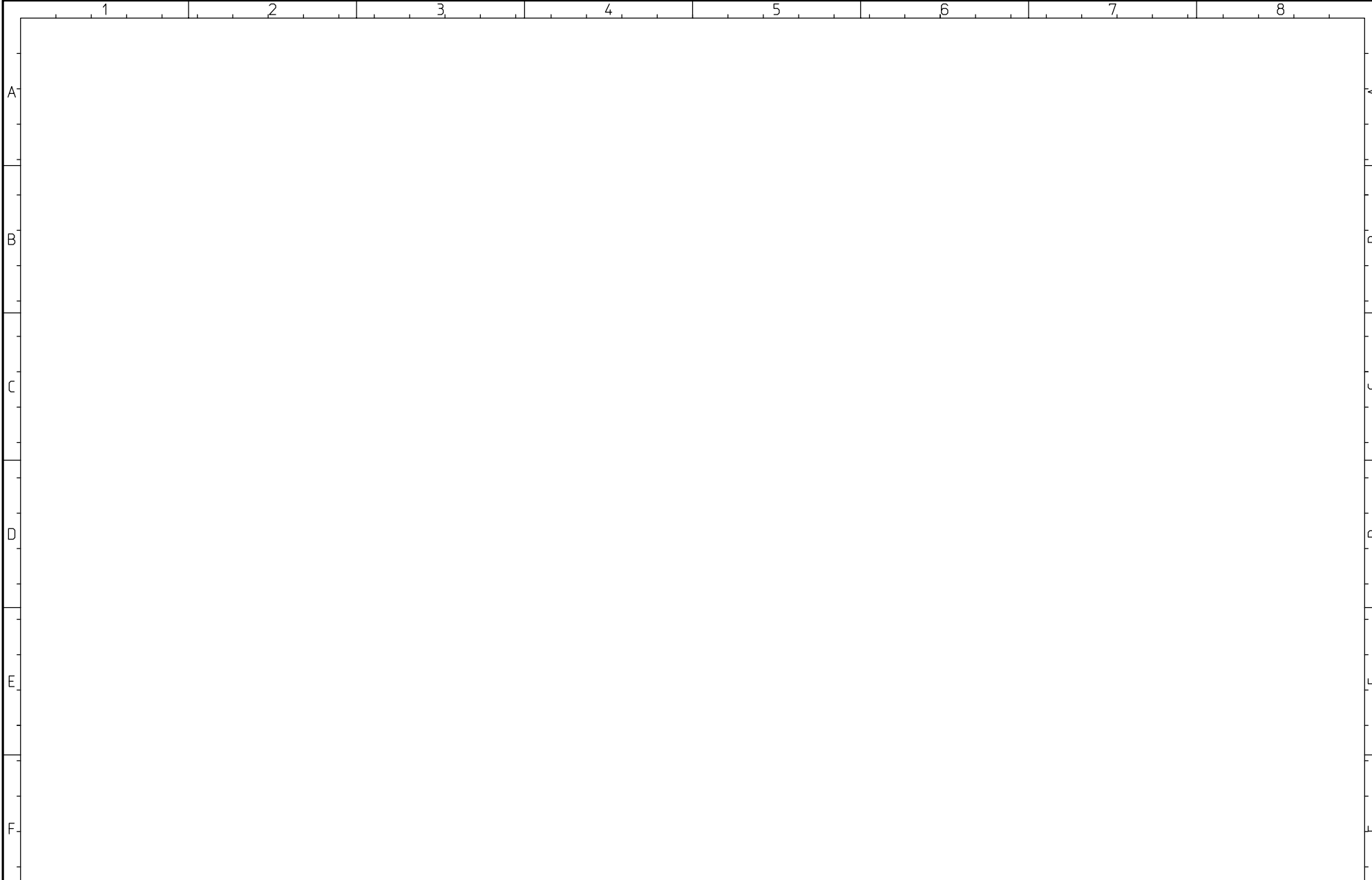
Weitergabe sowie Vervielfaeltigung dieses Dokuments, Verwertung und Mitteilung seines Inhalts sind verboten, soweit nicht The reproduction, distribution and utilization of this document as well as the communication of its contents to others without express



			CAD! KEINE MANUELLEN AENDERUNGEN ! CAD! DONT CHANGE MANUAL	 Herrenknecht AG Schlehenweg 2 D-77963 Schwanau 2 Tel.: 07824 302-0 Fax.: 07824 3403 Info@Herrenknecht.de	Projekt: project: M-1642-C	Reserve reserve	Stueckliste: parts list: 25186184	Fg.-Gruppe: funct.-group: .0	Blatt-Nr.: page-nr.: 24	
Index Index	Aenderung-Nr. Change No.:	Datum / Name date / name	Ausdruck-Datum: printout-date: 14.12.11		=Container	Zn.-Nr.: drawn-nr.: 3478-562-002-0	Datum: date: 26.08.2011	Bearb.: name: Th	letzte Aenderung: last modification: 14.12.11 Th	Blatt-Global: page-global: 24/166

Patent-, Gebrauchsmuster- oder Geschmacksmuster-Eintragung vorbehalten. of a patent, utility model or design.
 ausdrücklich gestattet. Zuwendungen verpflichten zu Schadenssz. Alle Rechte fuer den Fall der authorization is prohibited. Offenders will be held liable for the payment of damages. All rights reserved in the event of the grant
 Weitergabe sowie Vervielfaeltigung dieses Dokuments, Verwertung und Mitteilung seines Inhalts sind verboten, soweit nicht The reproduction, distribution and utilization of this document as well as the communication of its contents to others without express

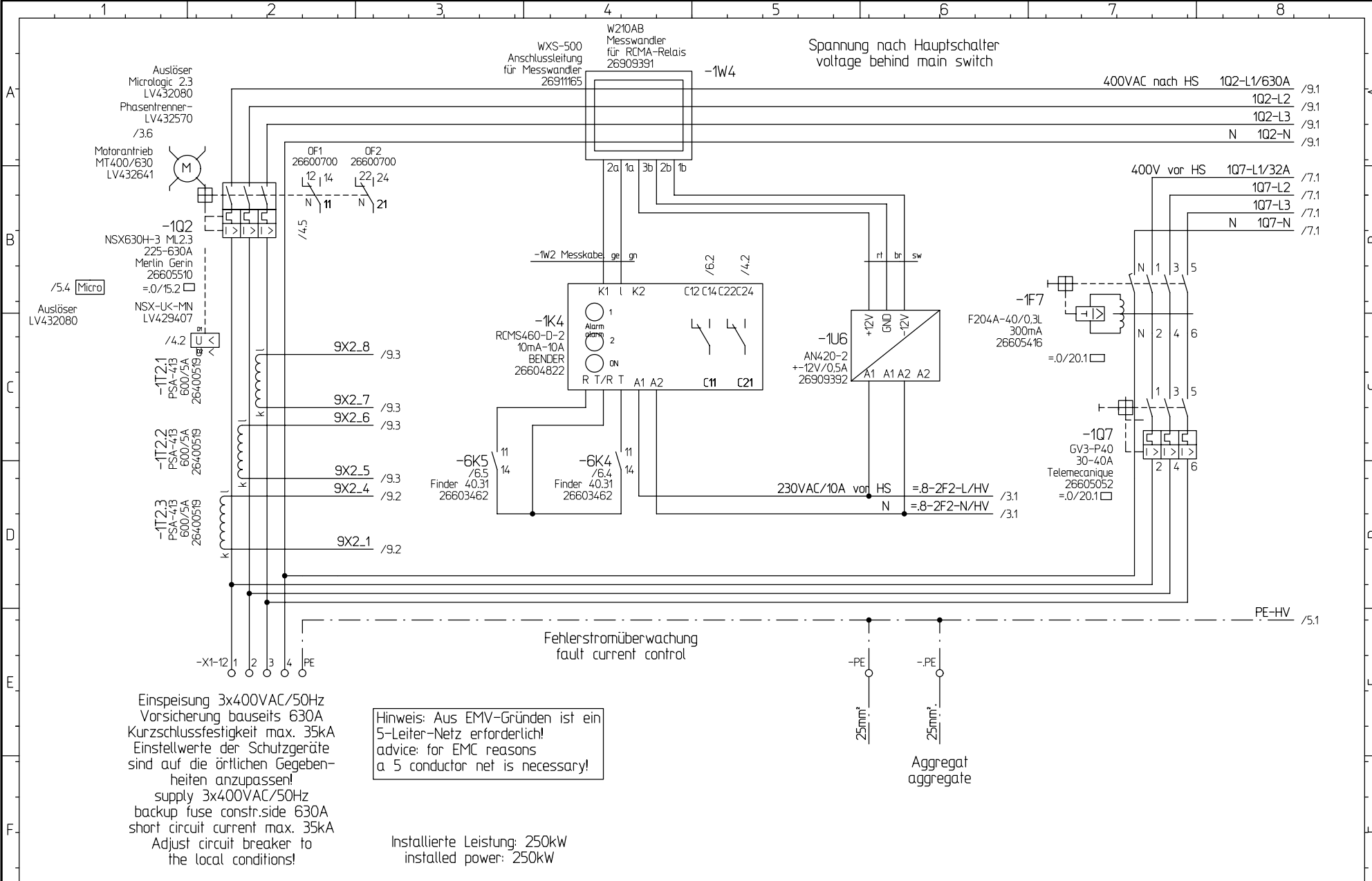

			CAD! KEINE MANUELLEN AENDERUNGEN! CAD! DONT CHANGE MANUAL	Herrenknecht AG Schlehenweg 2 D-77963 Schwanau 2 Tel.: 07824 302-0 Fax.: 07824 3403 Info@Herrenknecht.de	Projekt: M-1642-C =Container Zn.-Nr.: 3478-562-002-1	Einspeisung, Hauptschalter supply, main switch Einspeisung / supply main switch Hauptverteilung main distribution board +HV/MBB	Stueckliste: parts list: 25186184	Fg.-Gruppe: funct.-group: .1 Blatt-Nr.: page-nr.: 1 Blatt-Global: page-global: 25/166 von from 12	
Index	Änderung-Nr. Change No.:	Datum / Name date / name	Ausdruck-Datum: printout-date: 14.12.11		Datum: date: 26.08.2011	Bearb. name: Th	letzte Änderung: last modification: IB-Revision 14.12.11 Th		

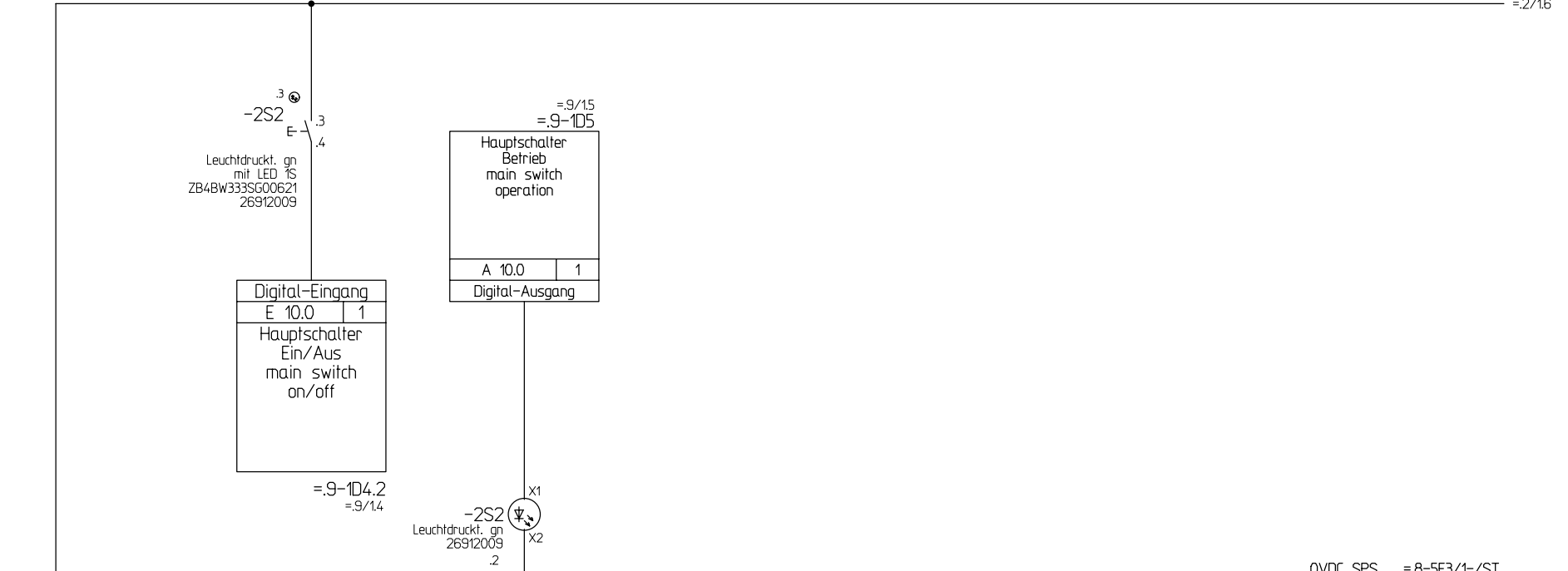

-X8-55 1
=8/55 =.8-5F3/1+/ST.
=8/55 =.8-5F3/1-/ST.
=8/55 =.8-PE-ST.

Digital-Eingang
E 10.0 1
Hauptschalter
Ein/Aus
main switch
on/off
=.9-104.2
=.9/14

Hauptschalter
Betrieb
main switch
operation
A 10.0 1
Digital-Ausgang
=.9/15
=.9-105

X1
-2S2
Leuchtdruckt. gn
26912009
X2
2

Index	Änderung-Nr. Change No.:	Datum / Name date / name
Index		

CAD! KEINE MANUELLEN
ÄNDERUNGEN!
CAD!
DONT CHANGE MANUAL
Ausdruck-Datum:
printout-date:
14.12.11



Herrenknecht AG
Schlehenweg 2
D-77963 Schwanau 2
Tel.: 07824 302-0
Fax.: 07824 3403
Info@Herrenknecht.de

Projekt:
project: M-1642-C
=Container
Zn.-Nr.:
drawn-nr.: 3478-562-002-.1

Hauptschalter Ein/Aus
main switch on/off
Einspeisung / supply main switch
Steuerstand
Control Cabin
+ST/CC
Datum:
date: 26.08.2011
Bearb.:
name: Th

Stueckliste:
parts list: 25186184
Fg.-Gruppe:
funct.-group: .1
Blatt-Nr.:
page-nr.: 2
Blatt-Global:
page-global: 26/166
von
from
letzte Änderung:
last modification:
IB-Revision 14.12.11 Th

ausdrücklich gestattet. Zuwiderhandlungen verpflichten zu Schadensersatz. Alle Rechte fuer den Fall der Autorisation ist prohibited. Offenders will be held liable for the payment of damages. All rights reserved in the event of the grant of a patent, utility model or design.

Weitergabe sowie Vervielfaeltigung dieses Dokuments, Verwertung und Mitteilung seines Inhalts sind verboten, soweit nicht anders angegeben. The reproduction, distribution and utilization of this document as well as the communication of its contents to others without express

Patent-, Gebrauchsmuster- oder Geschmacksmuster-Eintragung vorbehalten.
 of a patent, utility model or design.
 ausdrucklich gestattet. Zuwiderhandlungen verpflichten zu Schadenersatz. Alle Rechte fuer den Fall der Auhorisation is prohibited. Offenders will be held liable for the payment of damages. All rights reserved in the event of the grant
 Weitergabe sowie Vervielfaeltigung dieses Dokuments, Verwertung und Mitteilung seines Inhalts sind verboten, soweit nicht The reproduction, distribution and utilization of this document as well as the communication of its contents to others without express

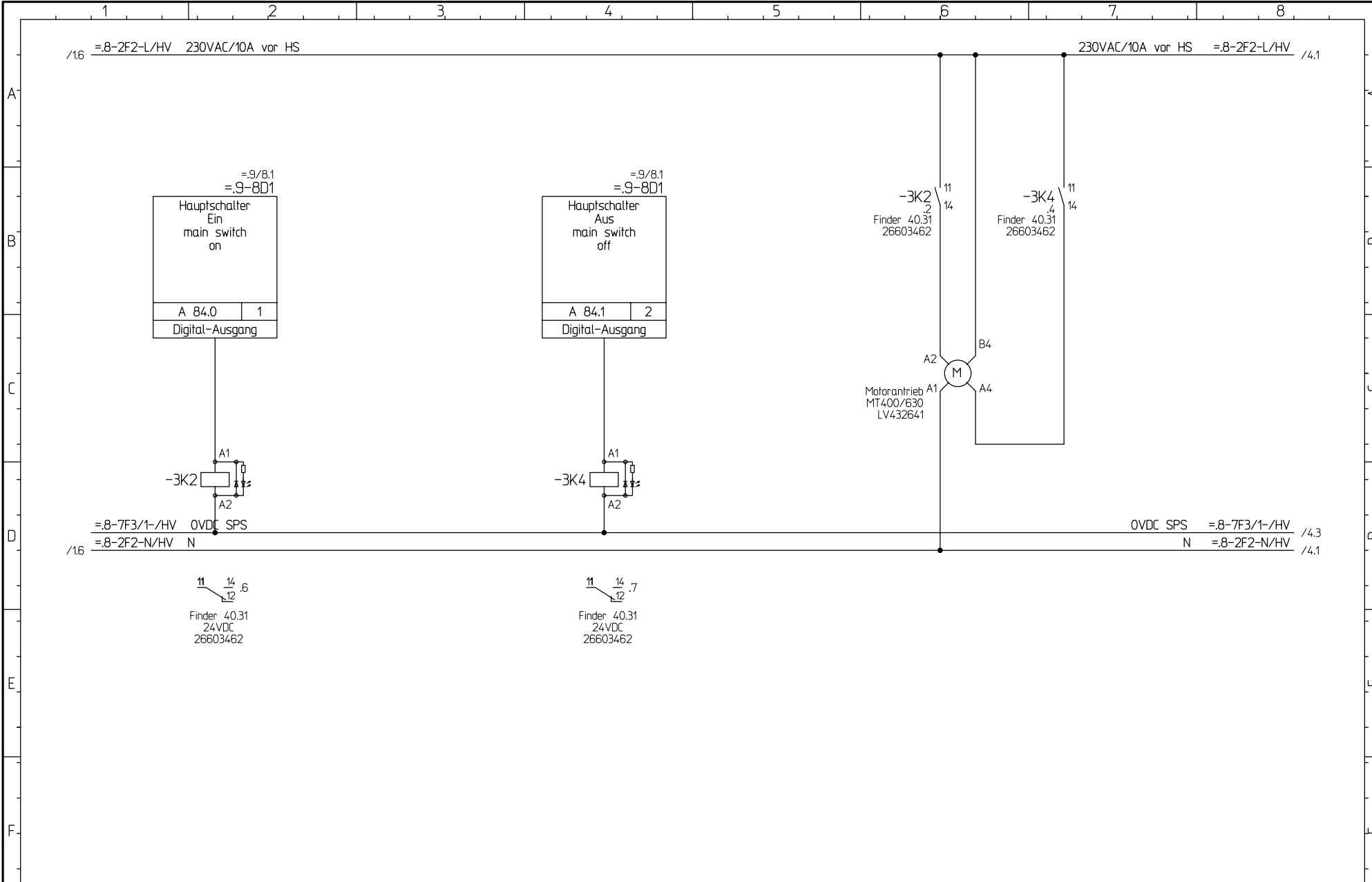

			CAD! KEINE MANUELLEN AENDERUNGEN! CAD! DONT CHANGE MANUAL		 Herrenknecht AG Schlehenweg 2 D-77963 Schwanau 2 Tel.: 07824 302-0 Fax.: 07824 3403 Info@Herrenknecht.de	Projekt: M-1642-C =Container		Steuerung Hauptschalter Ein/Aus control / main switch on/off Einspeisung / supply main switch		Stueckliste: parts list: 25186184		Fg.-Gruppe: funct.-group: .1		Blatt-Nr.: page-nr.: 3				
			Ausdruck-Datum: printout-date: 14.12.11			Zn.-Nr.: drawn-nr.: 3478-562-002-.1		Hauptverteilung main distribution board +HV/ MDB		Datum: date: 26.08.2011		Bearb.: name: Th		letzte Aenderung: last modification: IB-Revision 14.12.11 Th		Blatt-Global: page-global: 27/166		von from 12

Patent-, Gebrauchsmuster- oder Geschmacksmuster-Eintragung vorbehalten.
 of a patent, utility model or design.
 ausdrucklich gestattet. Zuwiderhandlungen verpflichten zu Schadensersatz. Alle Rechte fuer den Fall der authorisation is prohibited. Offenders will be held liable for the payment of damages. All rights reserved in the event of the grant
 Weitergabe sowie Vervielfaeltigung dieses Dokuments, Verwertung und Mitteilung seines Inhalts sind verboten, soweit nicht The reproduction, distribution and utilization of this document as well as the communication of its contents to others without express

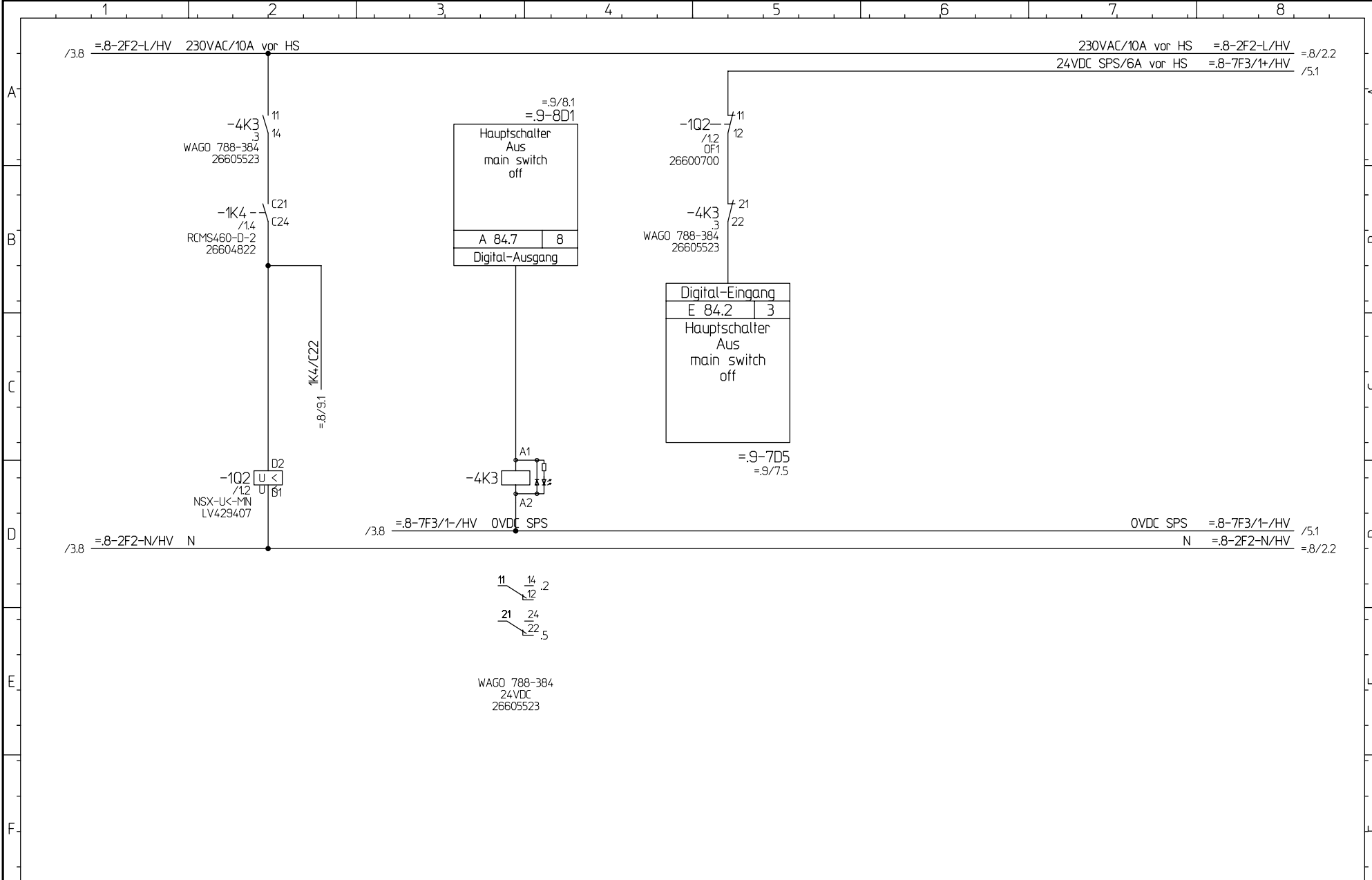

WAGO 788-384
24VDC
26605523

			CAD! KEINE MANUELLEN AENDERUNGEN! CAD! DONT CHANGE MANUAL		 Herrenknecht AG Schlehenweg 2 D-77963 Schwanau 2 Tel.: 07824 302-0 Fax.: 07824 3403 Info@Herrenknecht.de	Projekt: M-1642-C =Container		Unterspannungsspule, Hauptschalter E/A Einspeisung / supply main switch		Stueckliste: parts list: 25186184		Fg.-Gruppe: funct.-group: .1		Blatt-Nr.: page-nr.: 4				
			Ausdruck-Datum: printout-date: 14.12.11			Zn.-Nr.: drawn-nr.: 3478-562-002-.1		Hauptverteilung main distribution board +HV/MDB		Datum: date: 26.08.2011		Bearb.: name: Th		letzte Aenderung: last modification: IB-Revision 14.12.11 Th		Blatt-Global: page-global: 28/166		von from 12

Patent-, Gebrauchsmuster- oder Geschmacksmuster-Eintragung vorbehalten. of a patent, utility model or design.
 ausdrucklich gestattet. Zuwiderhandlungen verpflichten zu Schadensersatz. Alle Rechte fuer den Fall der Auhonanzation is prohibited. Offenders will be held liable for the payment of damages. All rights reserved in the event of the grant
 Weitergabe sowie Vervielfaeltigung dieses Dokuments, Verwertung und Mitteilung seines Inhalts sind verboten, soweit nicht The reproduction, distribution and utilization of this document as well as the communication of its contents to others without express

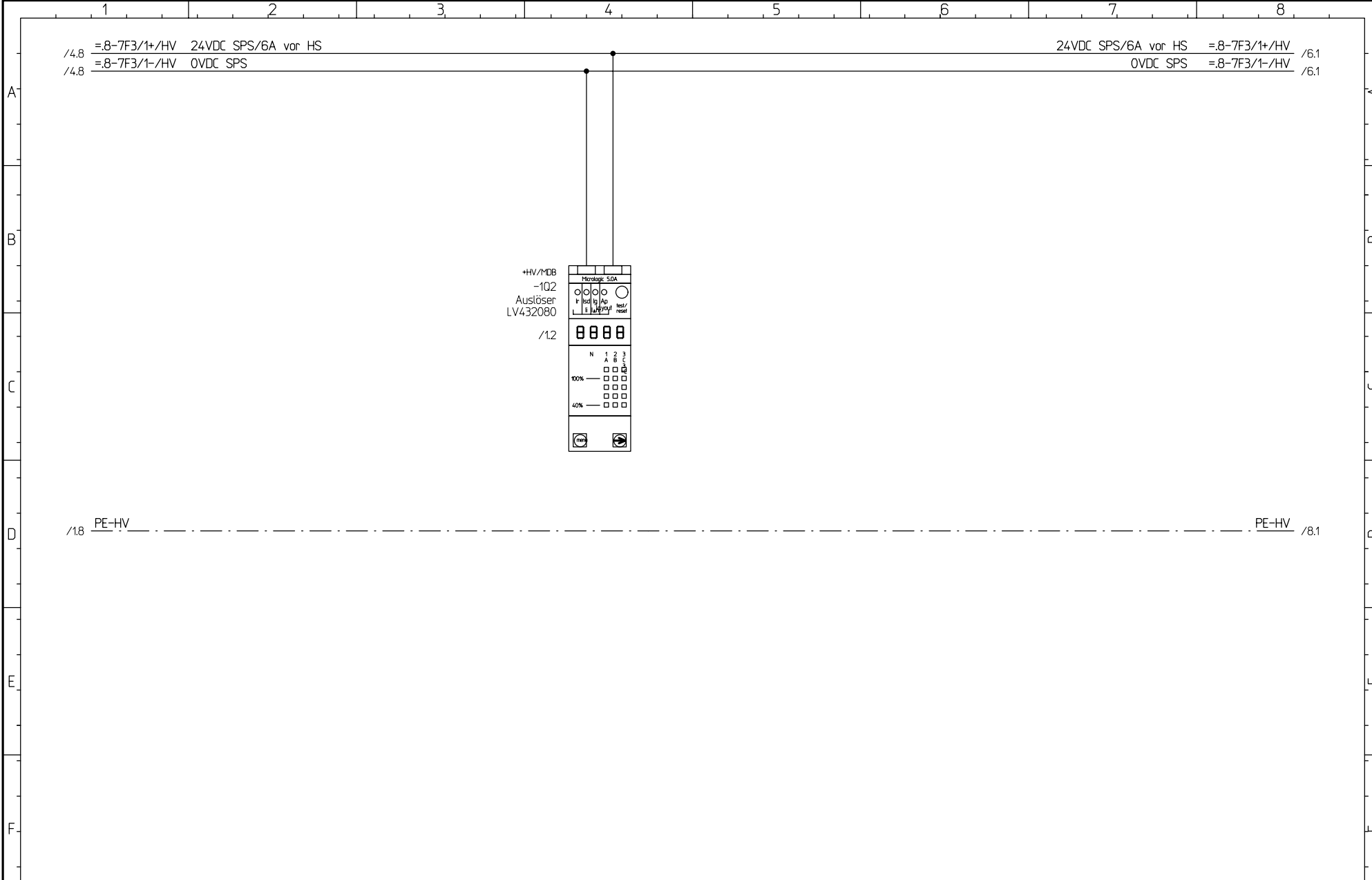

			CAD! KEINE MANUELLEN AENDERUNGEN! CAD! DONT CHANGE MANUAL		Herrenknecht AG Schlehenweg 2 D-77963 Schwanau 2 Tel.: 07824 302-0 Fax.: 07824 3403 Info@Herrenknecht.de		Projekt: M-1642-C =Container		Auswertung Hauptschalter interpretation main switch Einspeisung / supply main switch		Stueckliste: parts list: 25186184		Fg.-Gruppe: funct.-group: .1		Blatt-Nr.: page-nr.: 5			
			Ausdruck-Datum: printout-date: 14.12.11				Zn.-Nr.: drawn-nr.: 3478-562-002-.1		Datum: date: 26.08.2011		Bearb.: name: Th		letzte Aenderung: last modification: 14.12.11 Th		Blatt-Global: page-global: 29/166		von from 12	

Patent-, Gebrauchsmuster- oder Geschmacksmuster-Eintragung vorbehalten.
 of a patent, utility model or design.
 ausdrucklich gestattet. Zuwiderhandlungen verpflichten zu Schadenersatz. Alle Rechte fuer den Fall der Auhorisation is prohibited. Offenders will be held liable for the payment of damages. All rights reserved in the event of the grant
 Weitergabe sowie Vervielfaeltigung dieses Dokuments, Verwertung und Mitteilung seines Inhalts sind verboten, soweit nicht The reproduction, distribution and utilization of this document as well as the communication of its contents to others without express

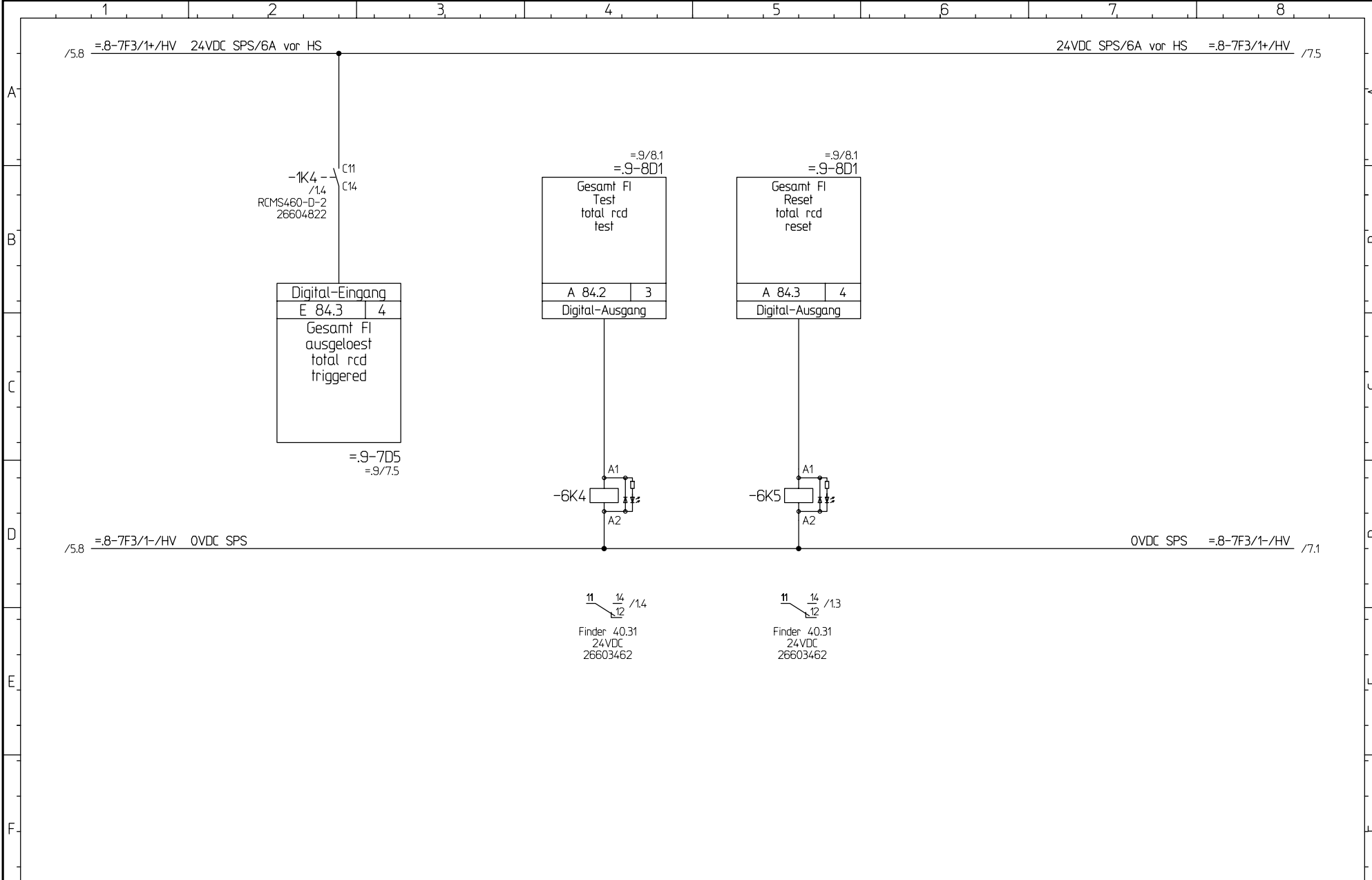

			CAD! KEINE MANUELLEN AENDERUNGEN! CAD! DONT CHANGE MANUAL		 Herrenknecht AG Schlehenweg 2 D-77963 Schwanau 2 Tel.: 07824 302-0 Fax.: 07824 3403 Info@Herrenknecht.de	Projekt: M-1642-C =Container		Fehlerstromüberwachung fault current control Einspeisung / supply main switch		Stueckliste: parts list: 25186184		Fg.-Gruppe: funct.-group: .1		Blatt-Nr.: page-nr.: 6				
Ausdruck-Datum: printout-date: 14.12.11						Zn.-Nr.: drawn-nr.: 3478-562-002-.1		Hauptverteilung main distribution board +HV/MDB		Datum: date: 26.08.2011		Bearb.: name: Th		letzte Aenderung: last modification: IB-Revision 14.12.11 Th		Blatt-Global: page-global: 30/166		von from 12

Spannung vor Hauptschalter
voltage before main switch

400V vor HS 107-L1/32A

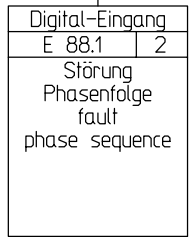
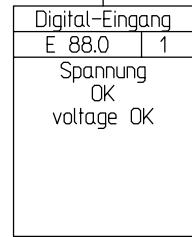
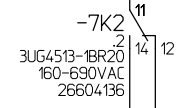
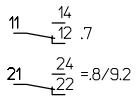
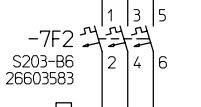
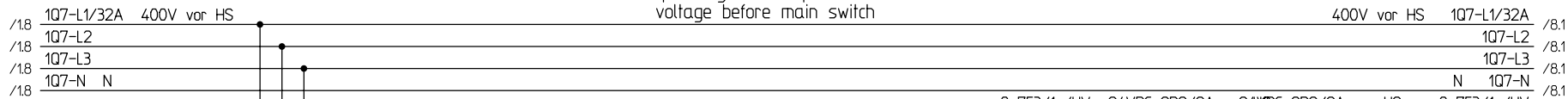

=8-7F3/1-/HV 0VDC SPS

0VDC SPS =8-7F3/1-/HV

Phasen-Überwachung
Phase-Control

Störung
Phasenfolge
fault
phase sequence

			CAD! KEINE MANUELLEN AENDERUNGEN! CAD! DONT CHANGE MANUAL		 Herrenknecht AG Schlehenweg 2 D-77963 Schwanau 2 Tel.: 07824 302-0 Fax.: 07824 3403 Info@Herrenknecht.de		Projekt: project: M-1642-C		Phasenfolgeüberwachung phase sequence control		Stueckliste: parts list: 25186184		Fg.-Gruppe: funct.-group: .1		Blatt-Nr.: page-nr.: 7	
			Ausdruck-Datum: printout-date: 14.12.11				=Container		Einspeisung / supply main switch		Hauptverteilung main distribution board +HV/MDB		Datum: date: 26.08.2011		Bearb.: name: Th	
Index	Aenderung-Nr. Change No.:	Datum / Name date / name					Zn.-Nr.: drawn-nr.: 3478-562-002-.1					Blatt-Global: page-global: 31/166		von from 12		

Patent-, Gebrauchsmuster- oder Geschmacksmuster-Eintragung vorbehalten. of a patent, utility model or design.
 ausdrücklich gestattet. Zuwiderhandlungen verpflichten zu Schadenersatz. Alle Rechte fuer den Fall der Auhonisation ist prohibited. Offenders will be held liable for the payment of damages. All rights reserved in the event of the grant
 Weitergabe sowie Vervielfaeltigung dieses Dokuments, Verwertung und Mitteilung seines Inhalts sind verboten, soweit nicht The reproduction, distribution and utilization of this document as well as the communication of its contents to others without express

Spannung vor Hauptschalter
voltage before main switch

- /7.8 107-L1/32A 400V vor HS
- /7.8 107-L2
- /7.8 107-L3
- /7.8 107-N N

/5.8 PE-HV

PE-HV /9.1

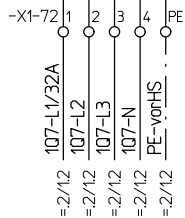

Achtung: Führt Spannung bei
ausgeschaltetem Hauptschalter!
Attention: Voltage present
when main switch is off!

			CAD! KEINE MANUELLEN ÄNDERUNGEN! CAD! DONT CHANGE MANUAL		Herrenknecht AG Schlehenweg 2 D-77963 Schwanau 2 Tel.: 07824 302-0 Fax.: 07824 3403 Info@Herrenknecht.de		Projekt: project: M-1642-C		Steuerspannung vor Hauptschalter zu ST control voltage before MS to CC		Stueckliste: parts list: 25186184		Fg.-Gruppe: funct.-group: .1		Blatt-Nr.: page-nr.: 8	
			Ausdruck-Datum: printout-date: 14.12.11				=Container		Einspeisung / supply main switch				Blatt-Global: page-global: 32/166		von from 12	
Index	Änderung-Nr. Change No.:	Datum / Name date / name				Zn.-Nr. drawn-nr.:	Hauptverteilung main distribution board +HV/MDB		Datum: date:	Bearb. name:	letzte Änderung: last modification: 14.12.11 Th					
						3478-562-002-.1			26.08.2011	Th						

Patent-, Gebrauchsmuster- oder Geschmacksmuster-Eintragung vorbehalten. of a patent, utility model or design.
 ausdrücklich gestattet. Zuwiderhandlungen verpflichten zu Schadensersatz. Alle Rechte fuer den Fall der authorisation is prohibited. Offenders will be held liable for the payment of damages. All rights reserved in the event of the grant
 Weitergabe sowie Vervielfaeltigung dieses Dokuments, Verwertung und Mitteilung seines Inhalts sind verboten, soweit nicht The reproduction, distribution and utilization of this document as well as the communication of its contents to others without express

Patent-, Gebrauchsmuster- oder
 Geschmacksmuster-Eintragung vorbehalten.
 of a patent, utility model or design.

ausdrücklich gestattet. Zuwiderhandlungen verpflichten
 zu Schadenersatz. Alle Rechte fuer den Fall der
 Aunehmation is prohibited. Offenders will be held liable for the
 payment of damages. All rights reserved in the event of the grant

Weitergabe sowie Vervielfaeltigung dieses Dokuments, Verwertung
 und Mitteilung seines Inhalts sind verboten, soweit nicht
 The reproduction, distribution and utilization of this document as
 well as the communication of its contents to others without express

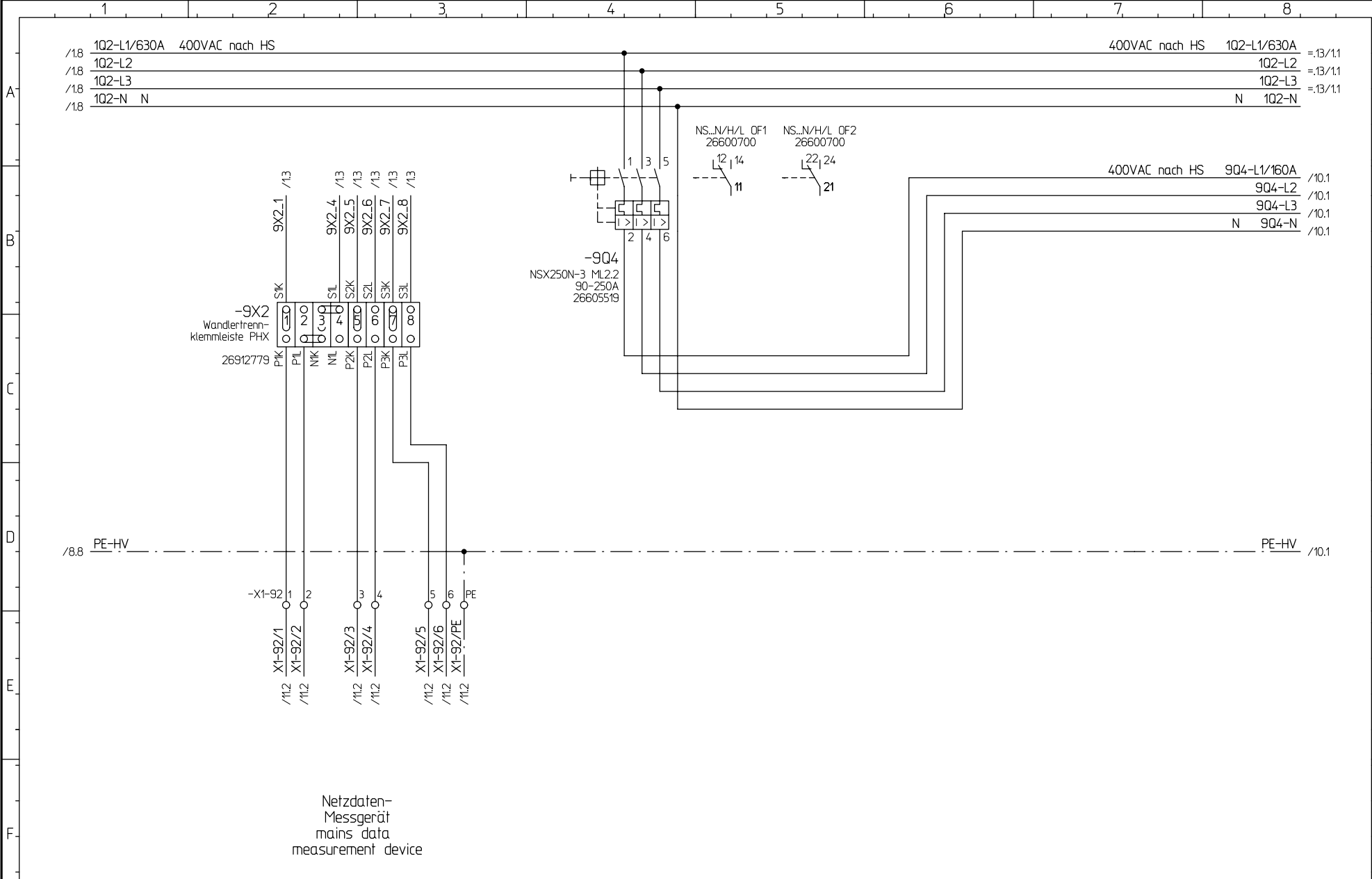



			CAD! KEINE MANUELLEN AENDERUNGEN! CAD! DONT CHANGE MANUAL	Herrenknecht AG Schleheweg 2 D-77963 Schwanau 2 Tel.: 07824 302-0 Fax.: 07824 3403 Info@Herrenknecht.de	Projekt: project: M-1642-C =Container	Versicherung Kleinverbraucher prefuse small consments Einspeisung / supply main switch	Stueckliste: parts list: 25186184	Fg.-Gruppe: funct.-group: .1	Blatt-Nr.: page-nr.: 9		
Index	Änderung-Nr. Change No.:	Datum / Name date / name	Ausdruck-Datum: printout-date: 14.12.11		Zn.-Nr.: drawn-nr.: 3478-562-002-.1	Hauptverteilung main distribution board +HV/MDB	Datum: date: 26.08.2011	Bearb.: name: Th	letzte Aenderung: last modification: 14.12.11 Th	Blatt-Global: page-global: 33/166	von from 12

Patent-, Gebrauchsmuster- oder
 Geschmacksmuster-Eintragung vorbehalten.
 of a patent, utility model or design.

ausdrücklich gestattet. Zuwiderhandlungen verpflichten
 zu Schadensersatz. Alle Rechte fuer den Fall der
 Autorisation is prohibited. Offenders will be held liable for the
 payment of damages. All rights reserved in the event of the grant

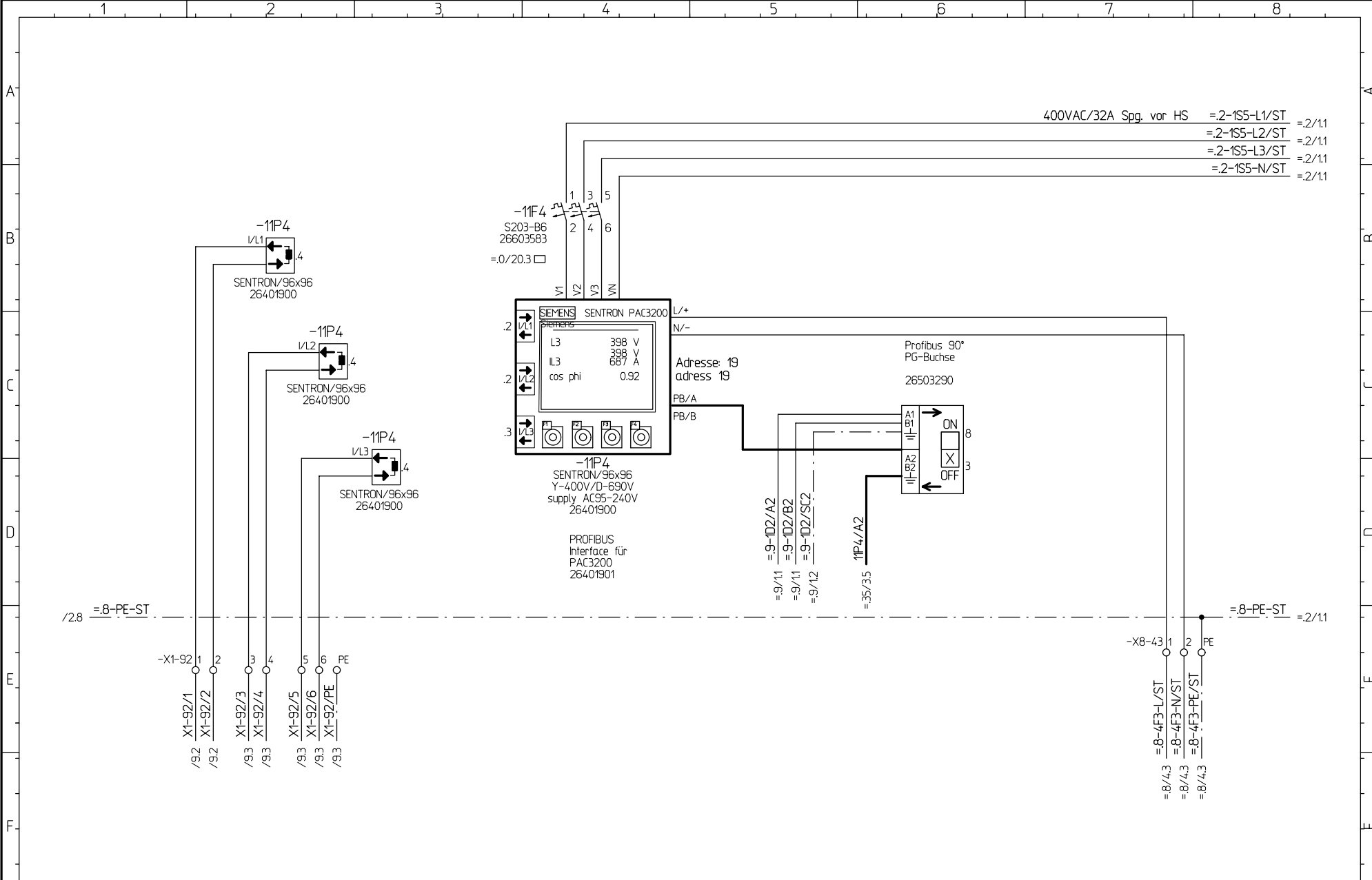
Weitergabe sowie Vervielfaeltigung dieses Dokuments, Verwertung
 und Mitteilung seines Inhalts sind verboten, soweit nicht
 The reproduction, distribution and utilization of this document as
 well as the communication of its contents to others without express





			CAD! KEINE MANUELLEN AENDERUNGEN! CAD! DONT CHANGE MANUAL		Herrenknecht AG Schleenweg 2 D-77963 Schwanau 2 Tel.: 07824 302-0 Fax: 07824 3403 Info@Herrenknecht.de		Projekt: project: M-1642-C		Netzdatenmessgerät mains data measurement device		Stueckliste: parts list: 25186184		Fg.-Gruppe: funct.-group: .1		Blatt-Nr.: page-nr.: 11	
			Ausdruck-Datum: printout-date: 14.12.11				=Container		Einspeisung / supply main switch				Blatt-Global: page-global: 35/166		von from 12	
Index	Aenderung-Nr. Change No.:	Datum / Name date / name					Zn.-Nr. drawn-nr.:	3478-562-002-1		Steuerstand Control Cabin +ST/CC	Datum: date: 26.08.2011	Bearb. name: Th	letzte Aenderung: last modification: IB-Revision 14.12.11 Th			

Patent-, Gebrauchsmuster- oder
Geschmacksmuster-Eintragung vorbehalten.
of a patent, utility model or design.

ausdrücklich gestattet. Zuwiderhandlungen verpflichten
zu Schadensersatz. Alle Rechte fuer den Fall der
Auhorisation is prohibited. Offenders will be held liable for the
payment of damages. All rights reserved in the event of the grant

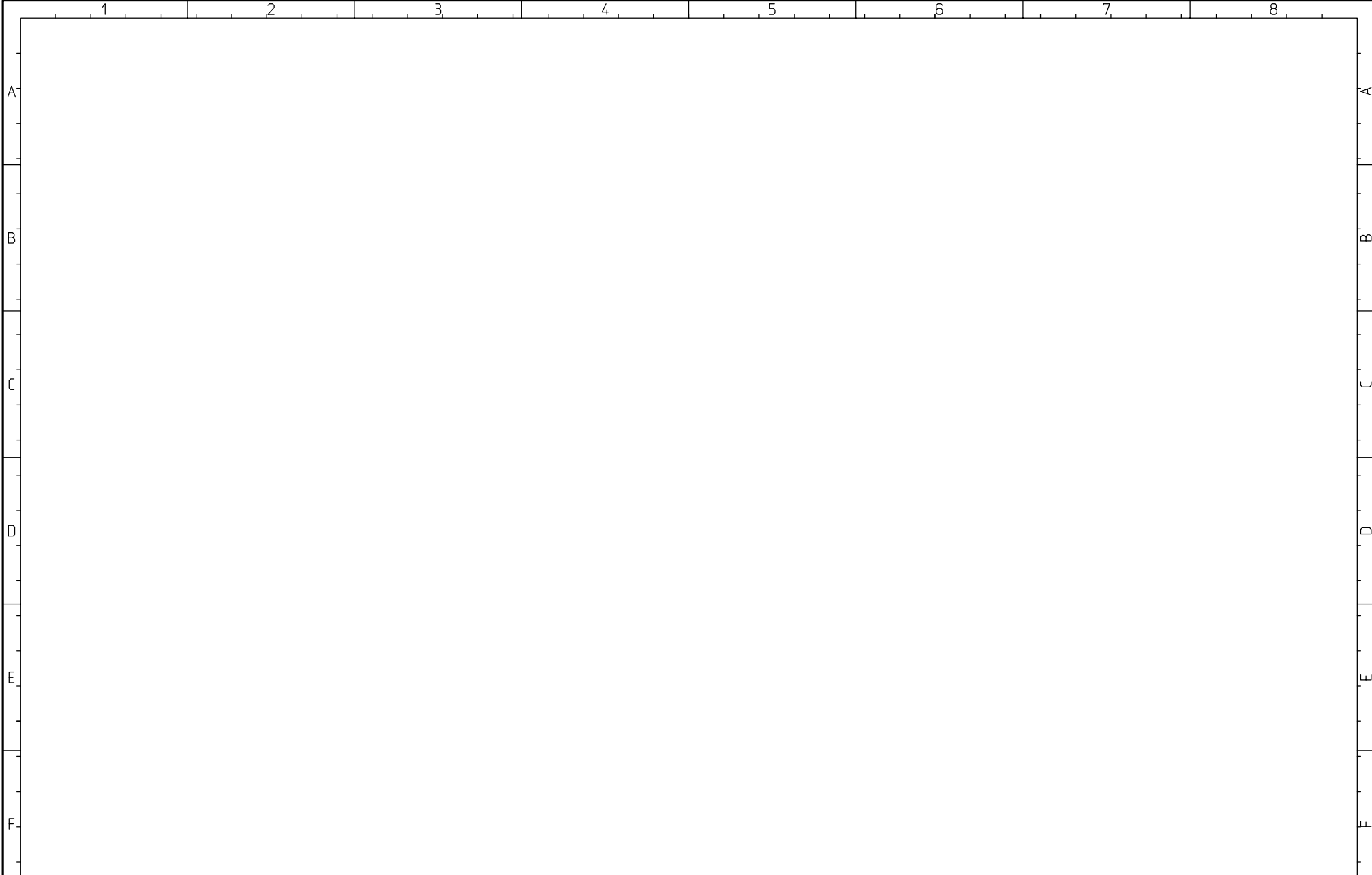
Weitergabe sowie Vervielfaeltigung dieses Dokuments, Verwertung
und Mitteilung seines Inhalts sind verboten, soweit nicht
The reproduction, distribution and utilization of this document as
well as the communication of its contents to others without express



			CAD! KEINE MANUELLEN AENDERUNGEN ! CAD! DONT CHANGE MANUAL	 Herrenknecht AG Schlehenweg 2 D-77963 Schwanau 2 Tel.: 07824 302-0 Fax.: 07824 3403 Info@Herrenknecht.de	Projekt: project: M-1642-C	Reserve reserve	Stueckliste: parts list: 25186184	Fg.-Gruppe: funct.-group: .1	Blatt-Nr.: page-nr.: 12
Index Index	Aenderung-Nr. Change No.:	Datum / Name date / name	Ausdruck-Datum: printout-date: 14.12.11		=Container	Einspeisung / supply main switch			Blatt-Global: page-global: 36/166
					Zn.-Nr.: drawn-nr.: 3478-562-002-.1	Datum: date: 26.08.2011	Bearb.: name: Th	letzte Aenderung: last modification: 14.12.11 Th	

Patent-, Gebrauchsmuster- oder
 Geschmacksmuster-Eintragung vorbehalten.
 of a patent, utility model or design.

ausdrücklich gestattet. Zuwiderhandlungen verpflichten
 zu Schadensersatz. Alle Rechte fuer den Fall der
 authorization is prohibited. Offenders will be held liable for the
 payment of damages. All rights reserved in the event of the grant

Weitergabe sowie Vervielfaeltigung dieses Dokuments, Verwertung
 und Mitteilung seines Inhalts sind verboten, soweit nicht
 The reproduction, distribution and utilization of this document as
 well as the communication of its contents to others without express

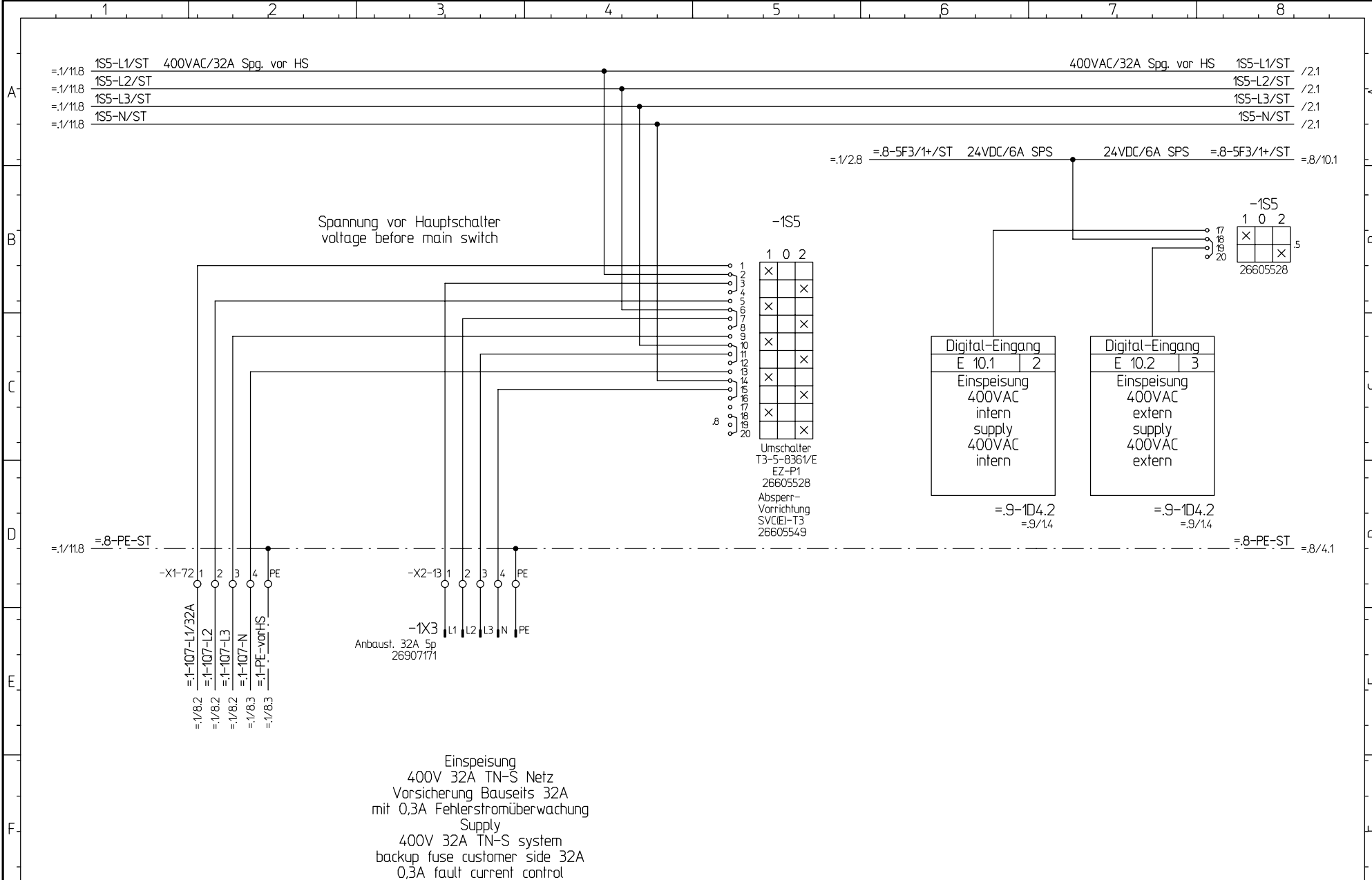

			CAD! KEINE MANUELLEN AENDERUNGEN! CAD! DONT CHANGE MANUAL	Herrenknecht AG Schlehenweg 2 D-77963 Schwanau 2 Tel.: 07824 302-0 Fax.: 07824 3403 Info@Herrenknecht.de	Projekt: project: M-1642-C =Container	Einspeisung 400VAC TN-S Netz supply 400VAC TN-S system Einspeisung extern / supply external	Stueckliste: parts list: 25186184	Fg.-Gruppe: funct.-group: .2 Blatt-Nr.: page-nr.: 1 Blatt-Global: page-global: 37/166 von from 4	
Index	Aenderung-Nr. Change No.:	Datum / Name date / name	Ausdruck-Datum: printout-date: 14.12.11		Zn.-Nr.: drawn-nr.: 3478-562-002-2	Steuerstand Control Cabin +ST/CC	Datum: date: 26.08.2011	Bearb.: name: Th	letzte Aenderung: last modification: IB-Revision 14.12.11 Th

Patent-, Gebrauchsmuster- oder Geschmacksmuster-Eintragung vorbehalten.
 of a patent, utility model or design.
 ausdrucklich gestattet. Zuwiderhandlungen verpflichten zu Schadensersatz. Alle Rechte fuer den Fall der Auhonization is prohibited. Offenders will be held liable for the payment of damages. All rights reserved in the event of the grant
 Weitergabe sowie Vervielfaeltigung dieses Dokuments, Verwertung und Mitteilung seines Inhalts sind verboten, soweit nicht The reproduction, distribution and utilization of this document as well as the communication of its contents to others without express

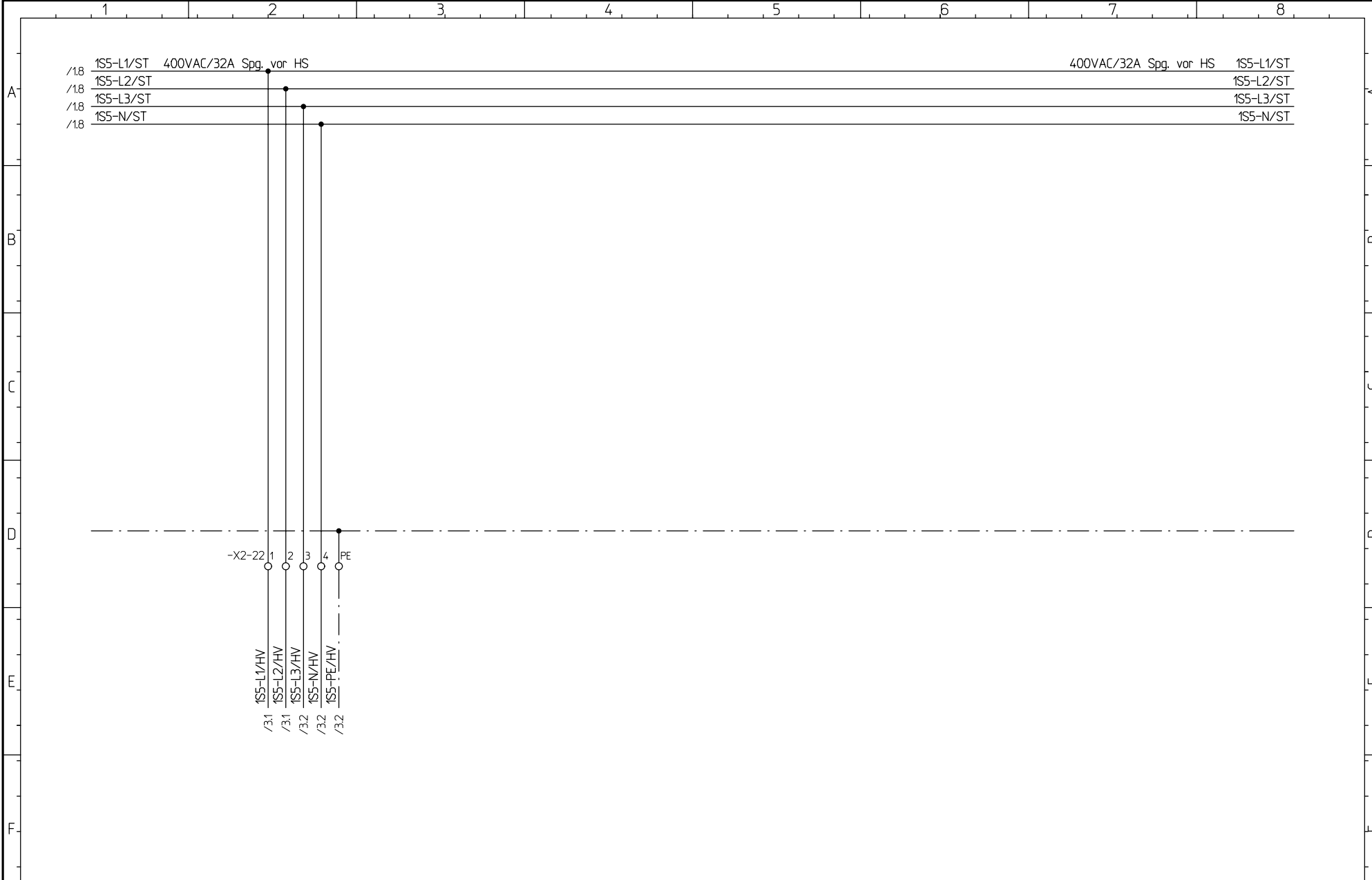

			CAD! KEINE MANUELLEN AENDERUNGEN! CAD! DONT CHANGE MANUAL		Herrenknecht AG Schlehenweg 2 D-77963 Schwanau 2 Tel.: 07824 302-0 Fax: 07824 3403 Info@Herrenknecht.de		Projekt: project: M-1642-C =Container		Abgang 400VAC TN-S Netz zu HV outlet 400VAC TN-S system to MDB Einspeisung extern / supply external		Stueckliste: parts list: 25186184		Fg.-Gruppe: funct.-group: .2		Blatt-Nr.: page-nr.: 2					
			Ausdruck-Datum: printout-date: 14.12.11				Zn.-Nr.: drawn-nr.: 3478-562-002-.2		Steuerstand Control Cabin +ST/CC		Datum: date: 26.08.2011		Bearb.: name: Th		letzte Aenderung: last modification: 14.12.11 Th		Blatt-Global: page-global: 38/166		von from 4	

400VAC/32A Spg. vor HS	1S5-L1/HV	=.6/12.1
	1S5-L2/HV	=.6/12.1
	1S5-L3/HV	=.6/12.1
	1S5-N/HV	=.6/12.1

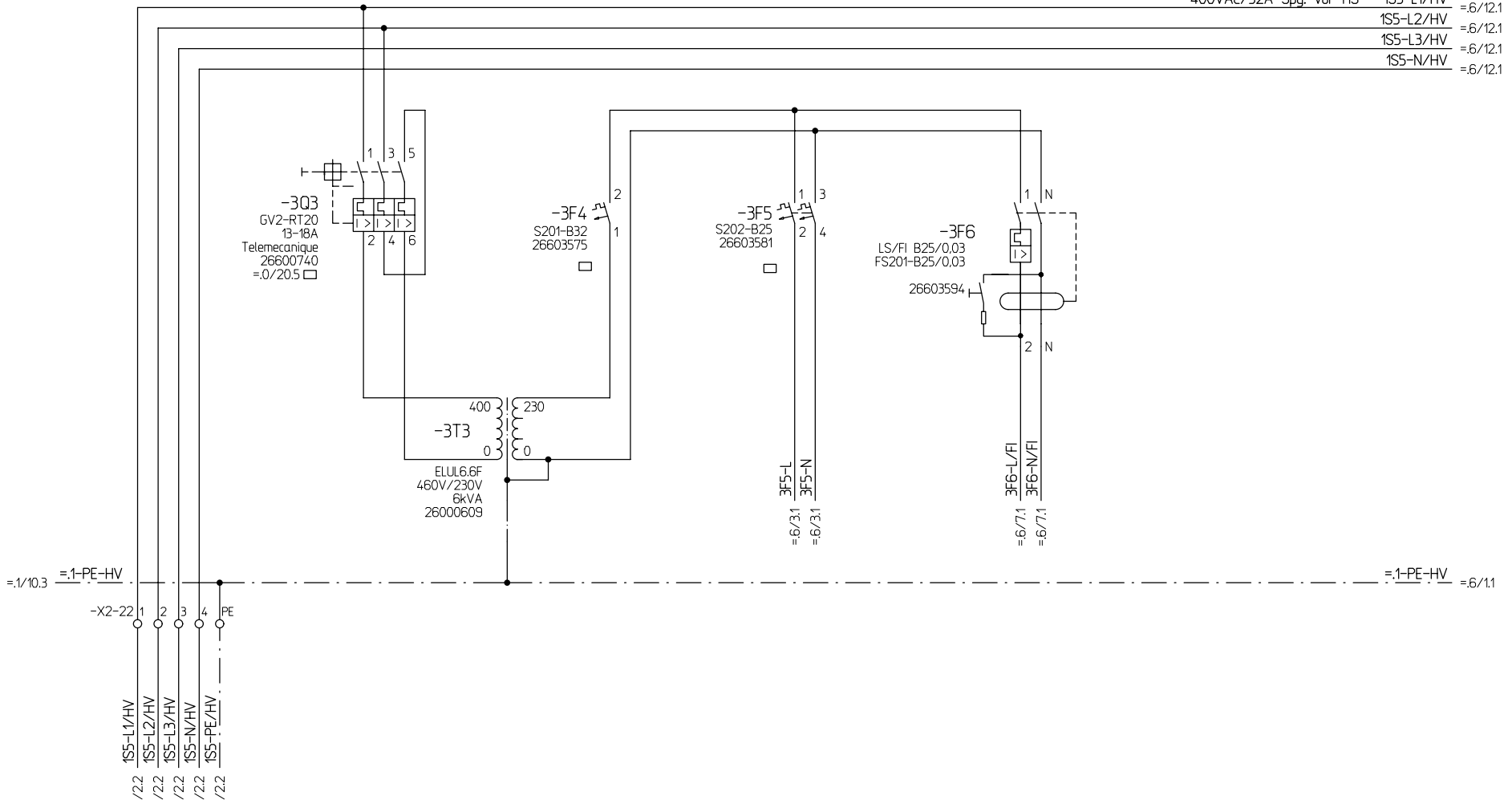

			CAD! KEINE MANUELLEN AENDERUNGEN! CAD! DONT CHANGE MANUAL	 Herrenknecht AG Schlehenweg 2 D-77963 Schwanau 2 Tel.: 07824 302-0 Fax.: 07824 3403 Info@Herrenknecht.de	Projekt: project: M-1642-C	Einspeisung 230VAC HV supply 230VAC MDB	Stueckliste: parts list: 25186184	Fg.-Gruppe: func.-group: .2	Blatt-Nr.: page-nr.: 3		
Index Index	Aenderung-Nr. Change No.:	Datum / Name date / name	Ausdruck-Datum: printout-date: 14.12.11		=Container	Einspeisung extern / supply external	Hauptverteilung main distribution board +HV/ MDB	Datum: date: 26.08.2011	Bearb. name: Th	letzte Aenderung: last modification: IB-Revision 14.12.11 Th	Blatt-Global: page-global: 39/166

Weitergabe sowie Vervielfältigung dieses Dokuments, Verwertung und Mitteilung seines Inhalts sind verboten, soweit nicht
 The reproduction, distribution and utilization of this document as well as the communication of its contents to others without express

			CAD! KEINE MANUELLEN ÄNDERUNGEN! CAD! DONT CHANGE MANUAL	 Herrenknecht AG Schlehenweg 2 D-77963 Schwanau 2 Tel.: 07824 302-0 Fax.: 07824 3403 Info@Herrenknecht.de	Projekt: project: M-1642-C	Reserve reserve	Stueckliste: parts list: 25186184	Fg.-Gruppe: funct.-group: .2	Blatt-Nr.: page-nr.: 4	
Index Index	Änderung-Nr. Change No.:	Datum / Name date / name	Ausdruck-Datum: printout-date: 14.12.11		=Container	Zn.-Nr.: drawn-nr.: 3478-562-002-.2	Datum: date: 26.08.2011	Bearb.: name: Th	letzte Änderung: last modification: IB-Revision 14.12.11 Th	Blatt-Global: page-global: 40/166

Patent-, Gebrauchsmuster- oder
 Geschmacksmuster-Eintragung vorbehalten.
 of a patent, utility model or design.

ausdrucklich gestattet. Zuwiderhandlungen verpflichten
 zu Schadensersatz. Alle Rechte fuer den Fall der
 authorisation is prohibited. Offenders will be held liable for the
 payment of damages. All rights reserved in the event of the grant

=.1/10.2	=.1-10K5-L1/S	400VAC/160A Kleinv.	400VAC/160A Kleinv.	=.1-10K5-L1/S	=.23/11
=.1/10.2	=.1-10K5-L2/S			=.1-10K5-L2/S	=.23/11
=.1/10.2	=.1-10K5-L3/S			=.1-10K5-L3/S	=.23/11
=.1/10.2	=.1-10K5-N/S	N		N =.1-10K5-N/S	=.23/11

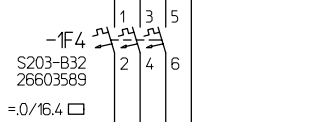

=.2/3.8 =.1-PE-HV =.1-PE-HV /3.1

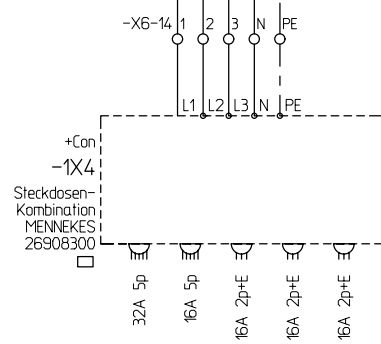

Patent-, Gebrauchsmuster- oder Geschmacksmuster-Eintragung vorbehalten. of a patent, utility model or design.
 ausdrucklich gestattet. Zuwiderhandlungen verpflichten zu Schadensersatz. Alle Rechte fuer den Fall der authorisation is prohibited. Offenders will be held liable for the payment of damages. All rights reserved in the event of the grant
 Weitergabe sowie Vervielfaeltigung dieses Dokuments, Verwertung und Mitteilung seines Inhalts sind verboten, soweit nicht The reproduction, distribution and utilization of this document as well as the communication of its contents to others without express

			CAD! KEINE MANUELLEN AENDERUNGEN! CAD! DONT CHANGE MANUAL		 Herrenknecht AG Schlehenweg 2 D-77963 Schwanau 2 Tel.: 07824 302-0 Fax.: 07824 3403 Info@Herrenknecht.de	Projekt: M-1642-C =Container		Steckdosenkombination socket combination Installation (Ventilation,Sockets,Light)		Stueckliste: parts list: 25186184		Fg.-Gruppe: funct.-group: .6		Blatt-Nr.: page-nr.: 1				
Ausdruck-Datum: printout-date: 14.12.11						Zn.-Nr.: drawn-nr.: 3478-562-002-6		Hauptverteilung main distribution board +HV/ MDB		Datum: date: 26.08.2011		Bearb.: name: Th		letzte Aenderung: last modification: IB-Revision 14.12.11 Th		Blatt-Global: page-global: 41/166		von from 12

Patent-, Gebrauchsmuster- oder
Geschmacksmuster-Eintragung vorbehalten.
of a patent, utility model or design.

ausdrücklich gestattet. Zuwiderhandlungen verpflichten
zu Schadensersatz. Alle Rechte fuer den Fall der
Auhorisation is prohibited. Offenders will be held liable for the
payment of damages. All rights reserved in the event of the grant

Weitergabe sowie Vervielfaeltigung dieses Dokuments, Verwertung
und Mitteilung seines Inhalts sind verboten, soweit nicht
The reproduction, distribution and utilization of this document as
well as the communication of its contents to others without express

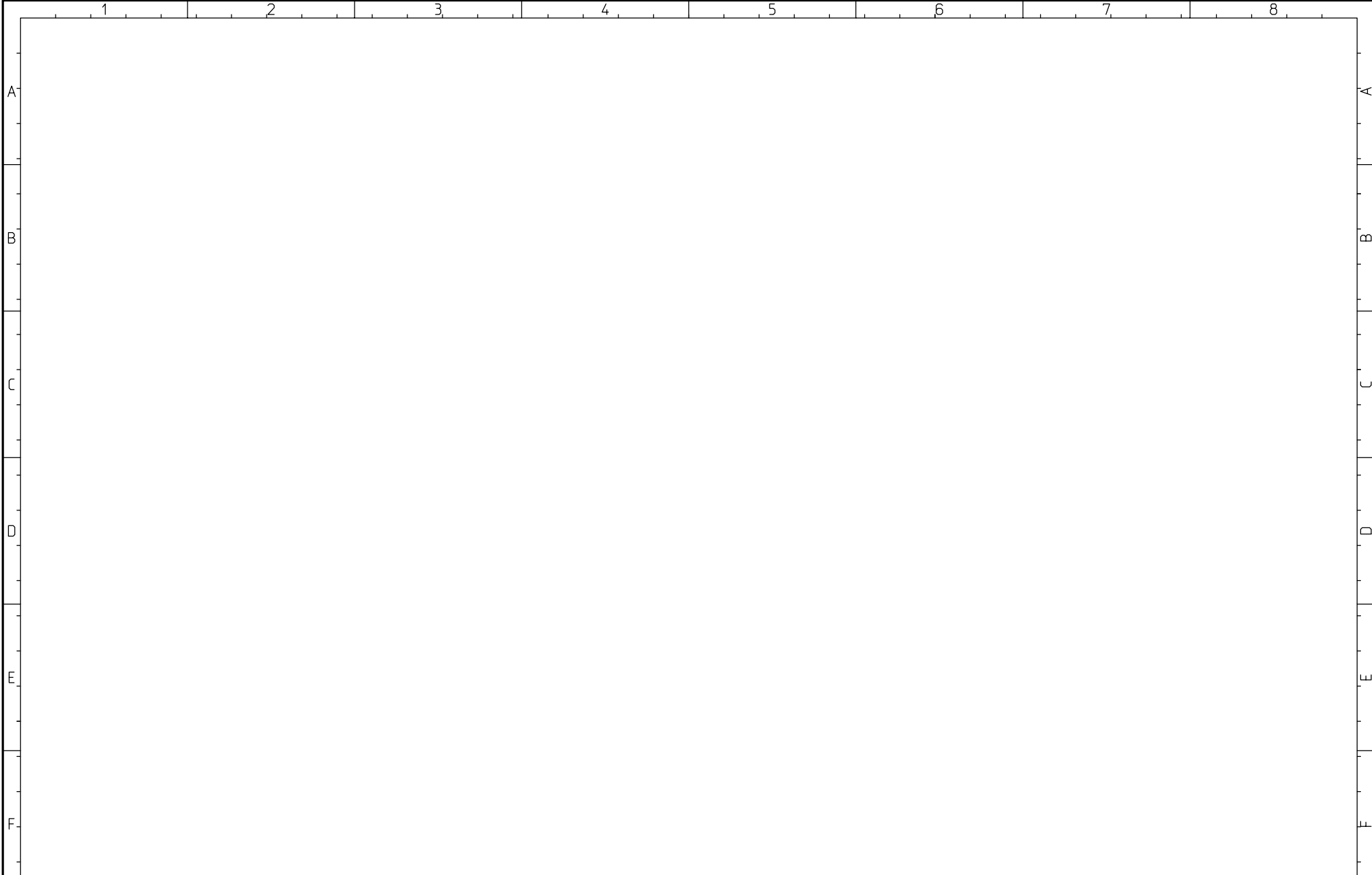

			CAD! KEINE MANUELLEN AENDERUNGEN ! CAD! DONT CHANGE MANUAL	 Herrenknecht AG Schlehenweg 2 D-77963 Schwanau 2 Tel.: 07824 302-0 Fax.: 07824 3403 Info@Herrenknecht.de	Projekt: project: M-1642-C	Reserve reserve	Stueckliste: parts list: 25186184	Fg.-Gruppe: funct.-group: .6	Blatt-Nr.: page-nr.: 2	
Index Index	Aenderung-Nr. Change No.:	Datum / Name date / name	Ausdruck-Datum: printout-date: 14.12.11		=Container	Zn.-Nr.: drawn-nr.: 3478-562-002-6	Datum: date: 26.08.2011	Bearb.: name: Th	letzte Aenderung: last modification: 14.12.11 Th	Blatt-Global: page-global: 42/166

Patent-, Gebrauchsmuster- oder Geschmacksmuster-Eintragung vorbehalten.
 of a patent, utility model or design.
 ausdrucklich gestattet. Zuwiderhandlungen verpflichten zu Schadenersatz. Alle Rechte fuer den Fall der authorisation is prohibited. Offenders will be held liable for the payment of damages. All rights reserved in the event of the grant
 Weitergabe sowie Vervielfaeltigung dieses Dokuments, Verwertung und Mitteilung seines Inhalts sind verboten, soweit nicht The reproduction, distribution and utilization of this document as well as the communication of its contents to others without express

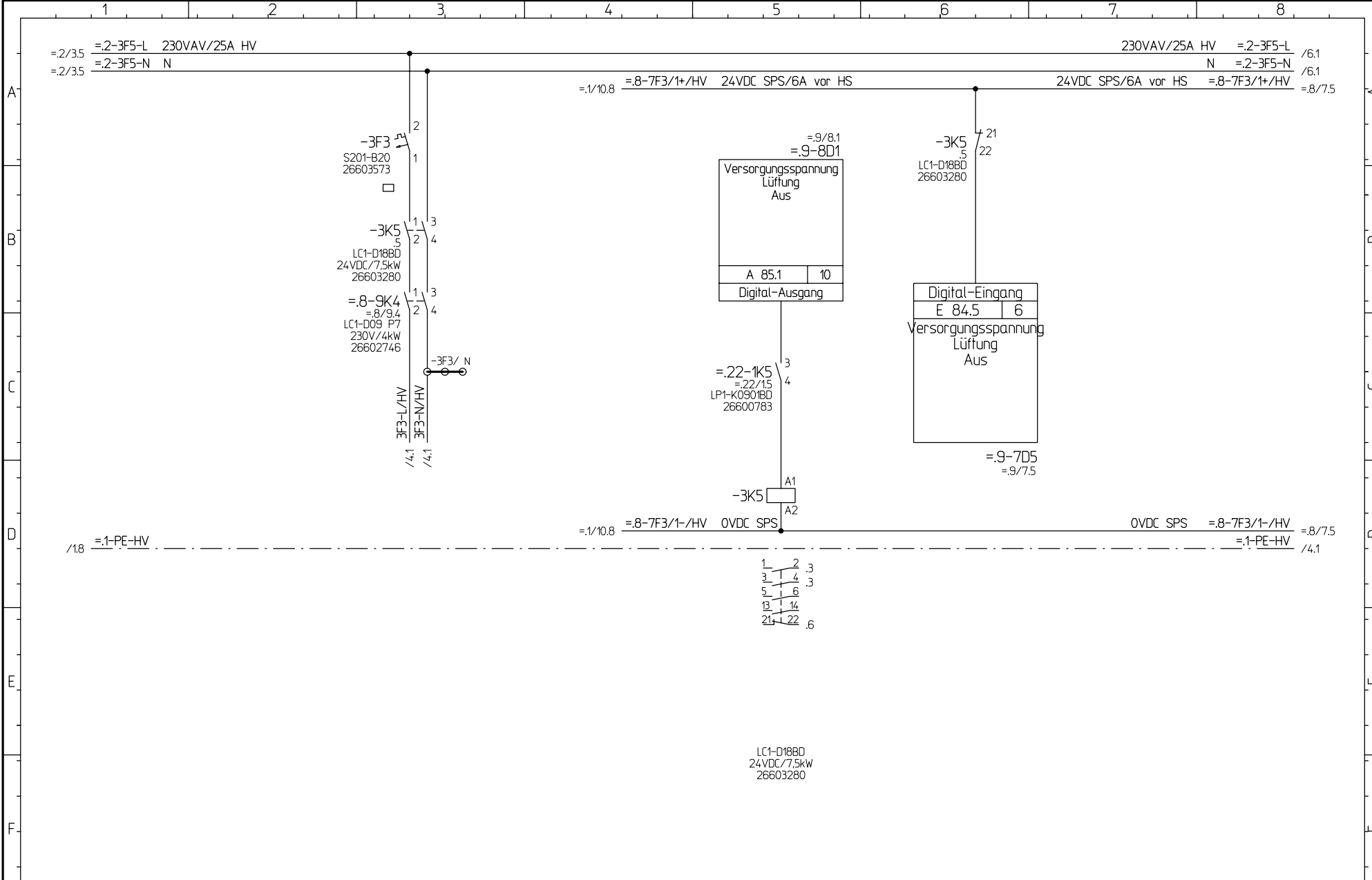

			CAD! KEINE MANUELLEN AENDERUNGEN! CAD! DONT CHANGE MANUAL		Herrenknecht AG Schlehenweg 2 D-77963 Schwanaau 2 Tel.: 07824 302-0 Fax.: 07824 3403 Info@Herrenknecht.de		Projekt: M-1642-C =Container		Versorgungsspannung Lüftung Distribution voltage ventilation Installation (Ventilation,Sockets,Light)		Stueckliste: parts list: 25186184		Fg.-Gruppe: funct.-group: .6		Blatt-Nr.: page-nr.: 3	
			Ausdruck-Datum: printout-date: 14.12.11				Zn.-Nr.: drawn-nr.: 3478-562-002-6		Hauptverteilung main distribution board +HV/MBB		Datum: date: 26.08.2011		Bearb.: name: Th		letzte Aenderung: last modification: IB-Revision 14.12.11 Th	
Index Index			Änderung-Nr. Change No.:												Blatt-Global: page-global: 43/166	

Patent-, Gebrauchsmuster- oder Geschmacksmuster-Eintragung vorbehalten. of a patent, utility model or design.
 ausdruecklich gestattet. Zuwiderhandlungen verpflichten zu Schadenersatz. Alle Rechte fuer den Fall der authorisation is prohibited. Offenders will be held liable for the payment of damages. All rights reserved in the event of the grant
 Weitergabe sowie Vervielfaeltigung dieses Dokuments, Verwertung und Mitteilung seines Inhalts sind verboten, soweit nicht The reproduction, distribution and utilization of this document as well as the communication of its contents to others without express

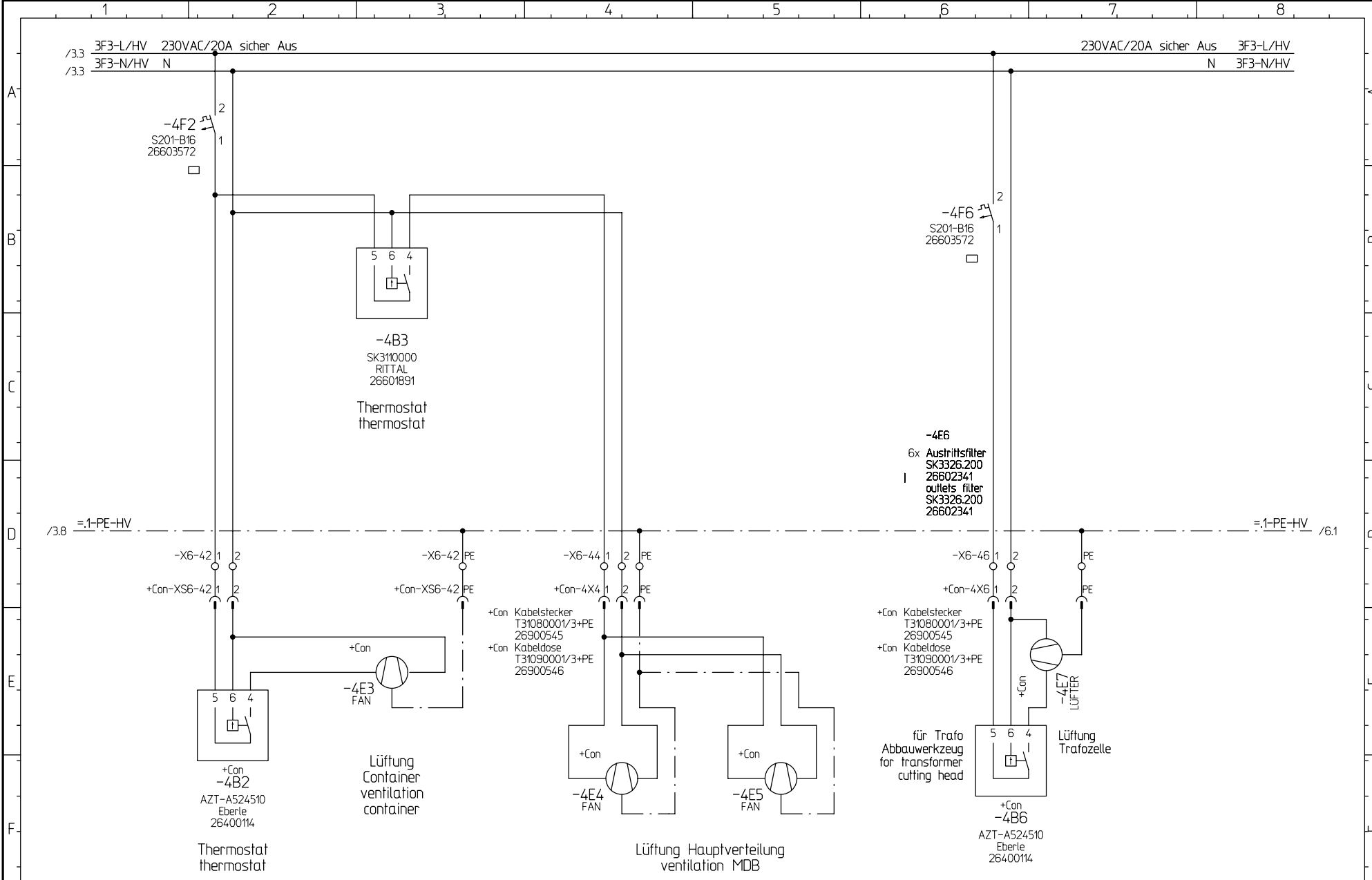



			CAD! KEINE MANUELLEN AENDERUNGEN! CAD! DONT CHANGE MANUAL		Herrenknecht AG Schlehenweg 2 D-77963 Schwanau 2 Tel.: 07824 302-0 Fax.: 07824 3403 Info@Herrenknecht.de		Projekt: M-1642-C =Container		Lüftung Container ventilation container Installation (Ventilation, Sockets, Light)		Stueckliste: parts list: 25186184		Fg.-Gruppe: funct.-group: .6		Blatt-Nr.: page-nr.: 4	
			Ausdruck-Datum: printout-date: 14.12.11				Zn.-Nr.: drawn-nr.: 3478-562-002-6		Hauptverteilung main distribution board +HV/ MDB		Datum: date: 26.08.2011		Bearb.: name: Th		letzte Aenderung: last modification: IB-Revision 14.12.11 Th	
Index Index			Änderung-Nr. Change No.:												Blatt-Global: page-global: 44/166	

Patent-, Gebrauchsmuster- oder
Geschmacksmuster-Eintragung vorbehalten.
of a patent, utility model or design.

ausdrücklich gestattet. Zuwiderhandlungen verpflichten
zu Schadensersatz. Alle Rechte fuer den Fall der
Auhorisation is prohibited. Offenders will be held liable for the
payment of damages. All rights reserved in the event of the grant

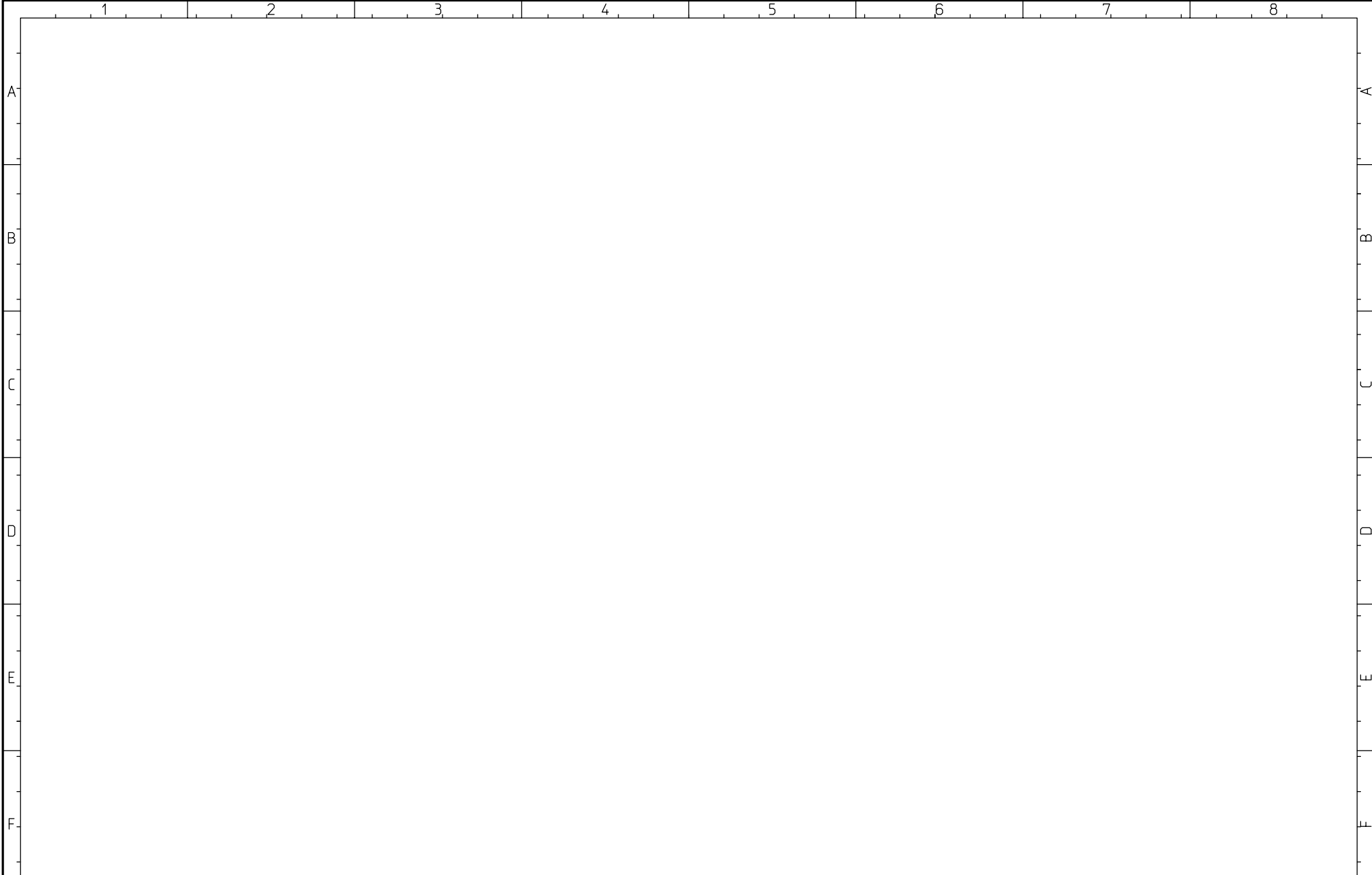
Weitergabe sowie Vervielfaeltigung dieses Dokuments, Verwertung
und Mitteilung seines Inhalts sind verboten, soweit nicht
The reproduction, distribution and utilization of this document as
well as the communication of its contents to others without express



			CAD! KEINE MANUELLEN AENDERUNGEN ! CAD! DONT CHANGE MANUAL	 Herrenknecht AG Schlehenweg 2 D-77963 Schwanau 2 Tel.: 07824 302-0 Fax.: 07824 3403 Info@Herrenknecht.de	Projekt: project: M-1642-C	Reserve reserve	Stueckliste: parts list: 25186184	Fg.-Gruppe: funct.-group: .6	Blatt-Nr.: page-nr.: 5	
Index Index	Aenderung-Nr. Change No.:	Datum / Name date / name	Ausdruck-Datum: printout-date: 14.12.11		=Container	Zn.-Nr.: drawn-nr.: 3478-562-002-6	Datum: date: 26.08.2011	Bearb.: name: Th	letzte Aenderung: last modification: 14.12.11 Th	Blatt-Global: page-global: 45/166

Patent-, Gebrauchsmuster- oder Geschmacksmuster-Eintragung vorbehalten.
 of a patent, utility model or design.
 ausdrucklich gestattet. Zuwiderhandlungen verpflichten zu Schadenersatz. Alle Rechte fuer den Fall der autorization is prohibited. Offenders will be held liable for the payment of damages. All rights reserved in the event of the grant
 Weitergabe sowie Vervielfaeltigung dieses Dokuments, Verwertung und Mitteilung seines Inhalts sind verboten, soweit nicht The reproduction, distribution and utilization of this document as well as the communication of its contents to others without express

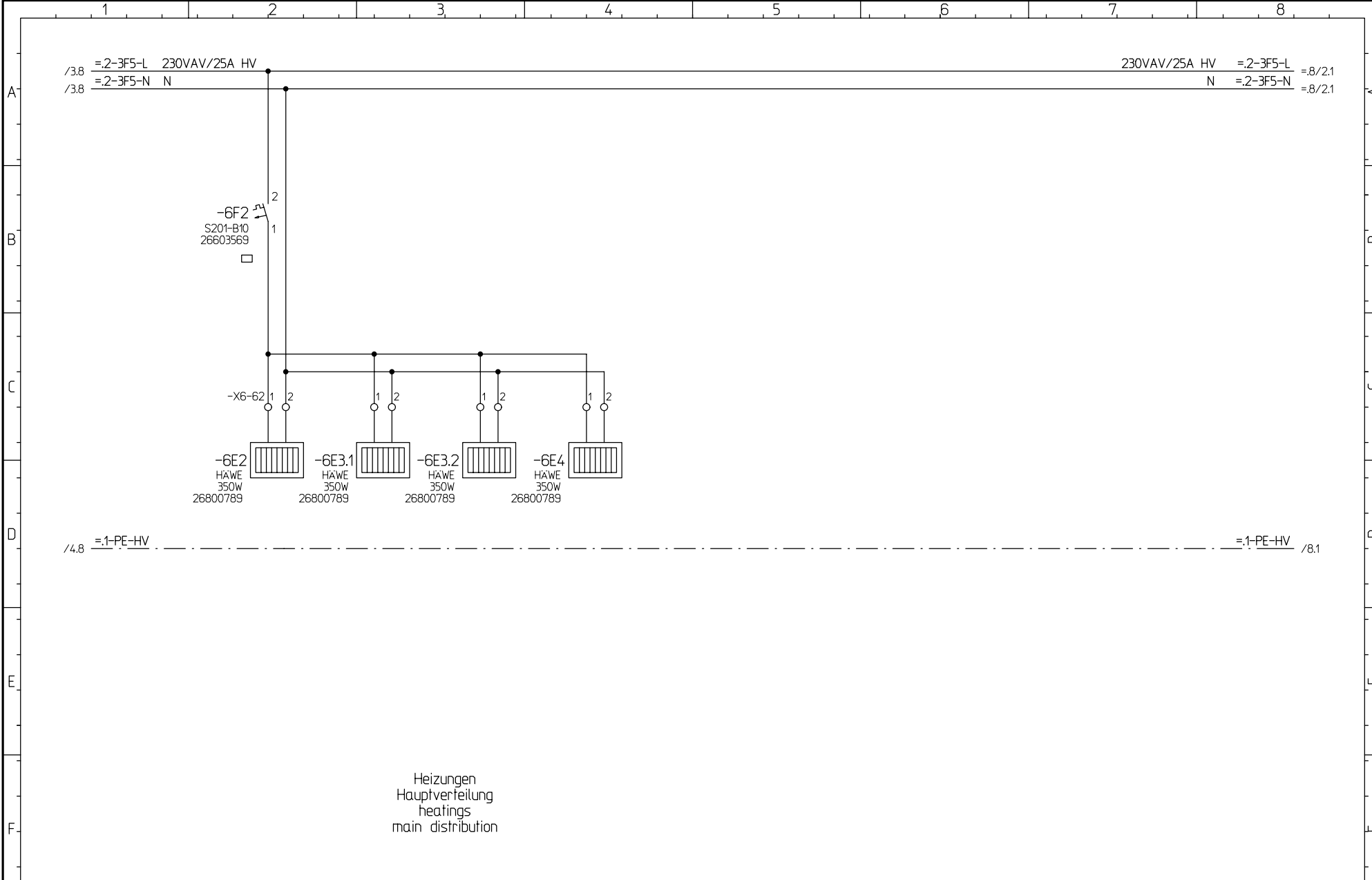



			CAD! KEINE MANUELLEN AENDERUNGEN! CAD! DONT CHANGE MANUAL	 Herrenknecht AG Schlehenweg 2 D-77963 Schwanau 2 Tel.: 07824 302-0 Fax.: 07824 3403 Info@Herrenknecht.de	Projekt: project: M-1642-C =Container	Heizung HV, Versorgungssp. Steuerstand heating MDB, power supply control cabin Installation (Ventilation,Sockets,Light)	Stueckliste: parts list: 25186184	Fg.-Gruppe: funct.-group: .6	Blatt-Nr.: page-nr.: 6		
Index	Aenderung-Nr. Change No.:	Datum / Name date / name	Ausdruck-Datum: printout-date: 14.12.11		Zn.-Nr.: drawn-nr.: 3478-562-002-6	Hauptverteilung main distribution board +HV/MDB	Datum: date: 26.08.2011	Bearb.: name: Th	letzte Aenderung: last modification: 14.12.11 Th	Blatt-Global: page-global: 46/166	von from 12

Patent-, Gebrauchsmuster- oder
Geschmacksmuster-Eintragung vorbehalten.
of a patent, utility model or design.

ausdrücklich gestattet. Zuwiderhandlungen verpflichten
zu Schadensersatz. Alle Rechte fuer den Fall der
Auhorisation ist prohibited. Offenders will be held liable for the
payment of damages. All rights reserved in the event of the grant

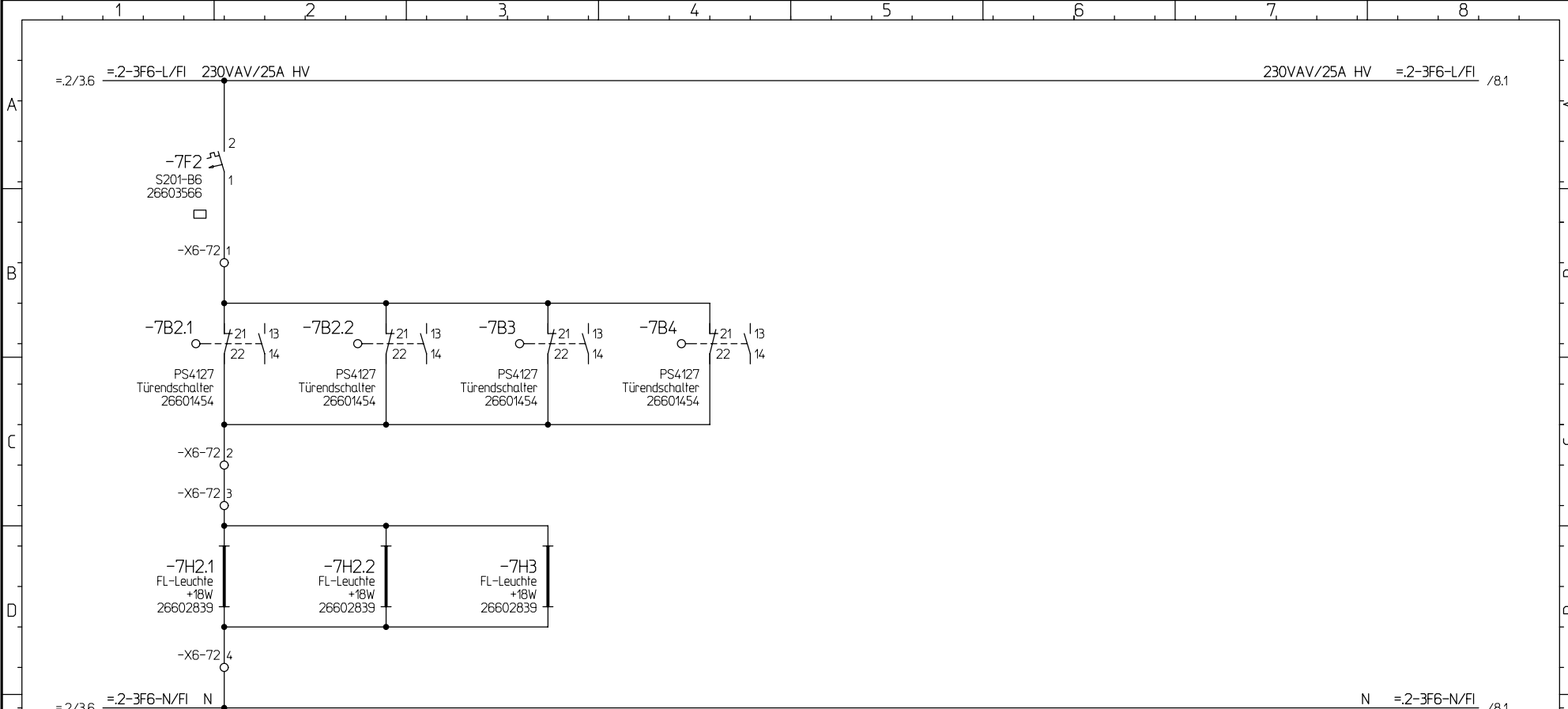
Weitergabe sowie Vervielfaeltigung dieses Dokuments, Verwertung
und Mitteilung seines Inhalts sind verboten, soweit nicht
The reproduction, distribution and utilization of this document as
well as the communication of its contents to others without express



			CAD! KEINE MANUELLEN AENDERUNGEN! CAD! DONT CHANGE MANUAL		Herrenknecht AG Schlehenweg 2 D-77963 Schwanau 2 Tel.: 07824 302-0 Fax.: 07824 3403 Info@Herrenknecht.de		Projekt: project: M-1642-C =Container		Beleuchtung Schaltschrank HV lighting cabinet MDB Installation (Ventilation,Sockets,Light)		Stueckliste: parts list: 25186184		Fg.-Gruppe: funct.-group: .6		Blatt-Nr.: page-nr.: 7	
			Ausdruck-Datum: printout-date: 14.12.11				Zn.-Nr.: drawn-nr.: 3478-562-002-6		Hauptverteilung main distribution board +HV/ MDB		Datum: date: 26.08.2011		Bearb.: name: Th		letzte Aenderung: last modification: IB-Revision 14.12.11 Th	
Index Index			Aenderung-Nr. Change No.:				Datum / Name date / name								Blatt-Global: page-global: 47/166	

Patent-, Gebrauchsmuster- oder Geschmacksmuster-Eintragung vorbehalten.
 of a patent, utility model or design.
 ausdrucklich gestattet. Zuwiderhandlungen verpflichten zu Schadensersatz. Alle Rechte fuer den Fall der authorisation is prohibited. Offenders will be held liable for the payment of damages. All rights reserved in the event of the grant
 Weitergabe sowie Vervielfaeltigung dieses Dokuments, Verwertung und Mitteilung seines Inhalts sind verboten, soweit nicht The reproduction, distribution and utilization of this document as well as the communication of its contents to others without express

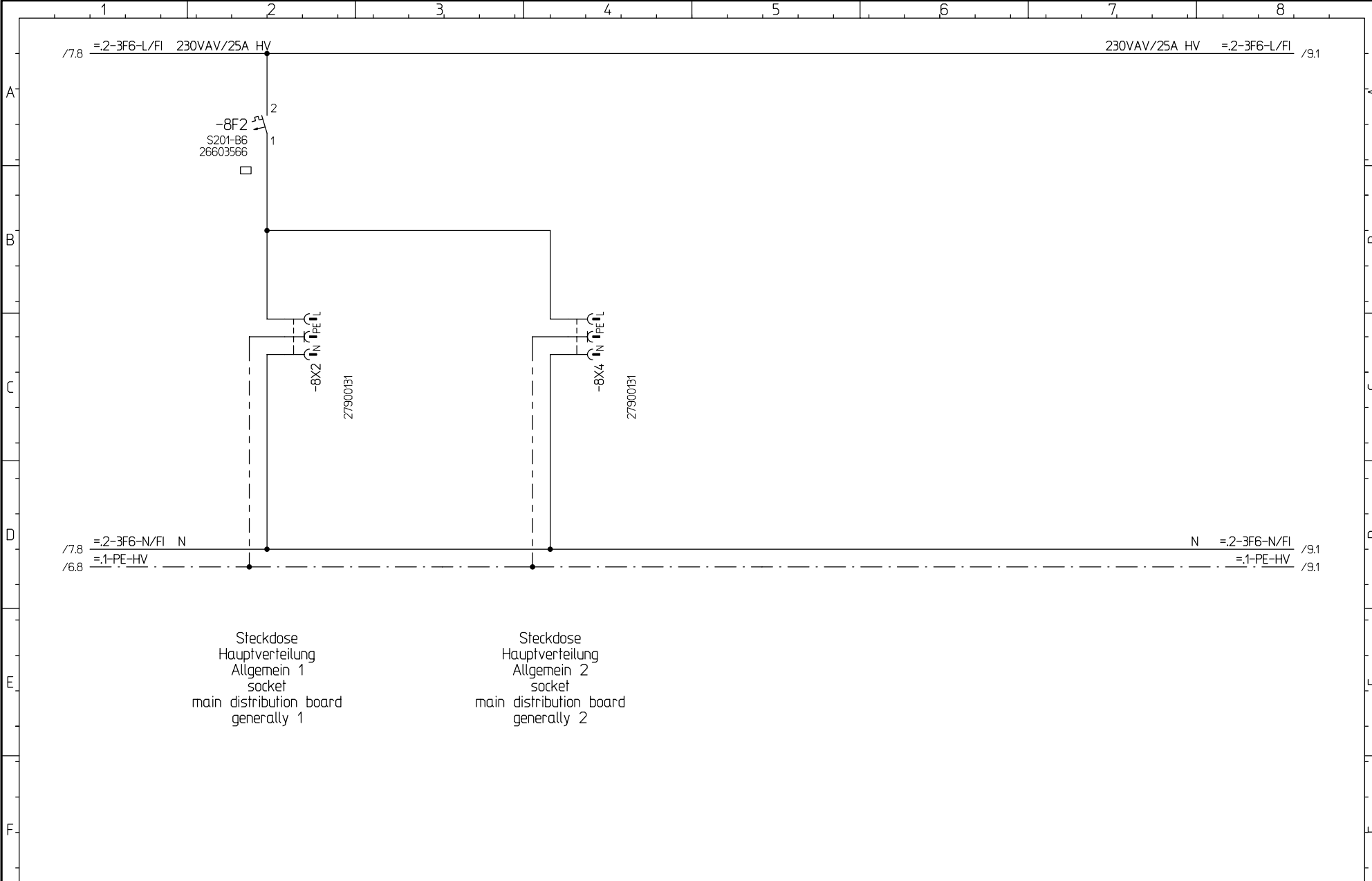

Steckdose
Hauptverteilung
Allgemein 1
socket
main distribution board
generally 1

Steckdose
Hauptverteilung
Allgemein 2
socket
main distribution board
generally 2

CAD! KEINE MANUELLEN AENDERUNGEN! CAD! DONT CHANGE MANUAL			 Herrenknecht AG Schlehenweg 2 D-77963 Schwanau 2 Tel.: 07824 302-0 Fax.: 07824 3403 Info@Herrenknecht.de	Projekt: M-1642-C =Container		Steckdosen Hauptverteilung sockets main distribution board Installation (Ventilation,Sockets,Light)		Stueckliste: parts list: 25186184	Fg.-Gruppe: funct.-group: .6	Blatt-Nr.: page-nr.: 8
Index Index	Aenderung-Nr. Change No.:	Datum / Name date / name		Ausdruck-Datum: printout-date: 14.12.11	Zn.-Nr.: drawn-nr.: 3478-562-002-6	Hauptverteilung main distribution board +HV/ MDB	Datum: date: 26.08.2011	Bearb.: name: Th	letzte Aenderung: last modification: IB-Revision 14.12.11 Th	Blatt-Global: page-global: 48/166

Patent-, Gebrauchsmuster- oder Geschmacksmuster-Eintragung vorbehalten. of a patent, utility model or design.
 ausdrücklich gestattet. Zuwiderhandlungen verpflichten zu Schadensersatz. Alle Rechte fuer den Fall der Auhorisation ist prohibited. Offenders will be held liable for the payment of damages. All rights reserved in the event of the grant
 Weitergabe sowie Vervielfaeltigung dieses Dokuments, Verwertung und Mitteilung seines Inhalts sind verboten, soweit nicht The reproduction, distribution and utilization of this document as well as the communication of its contents to others without express

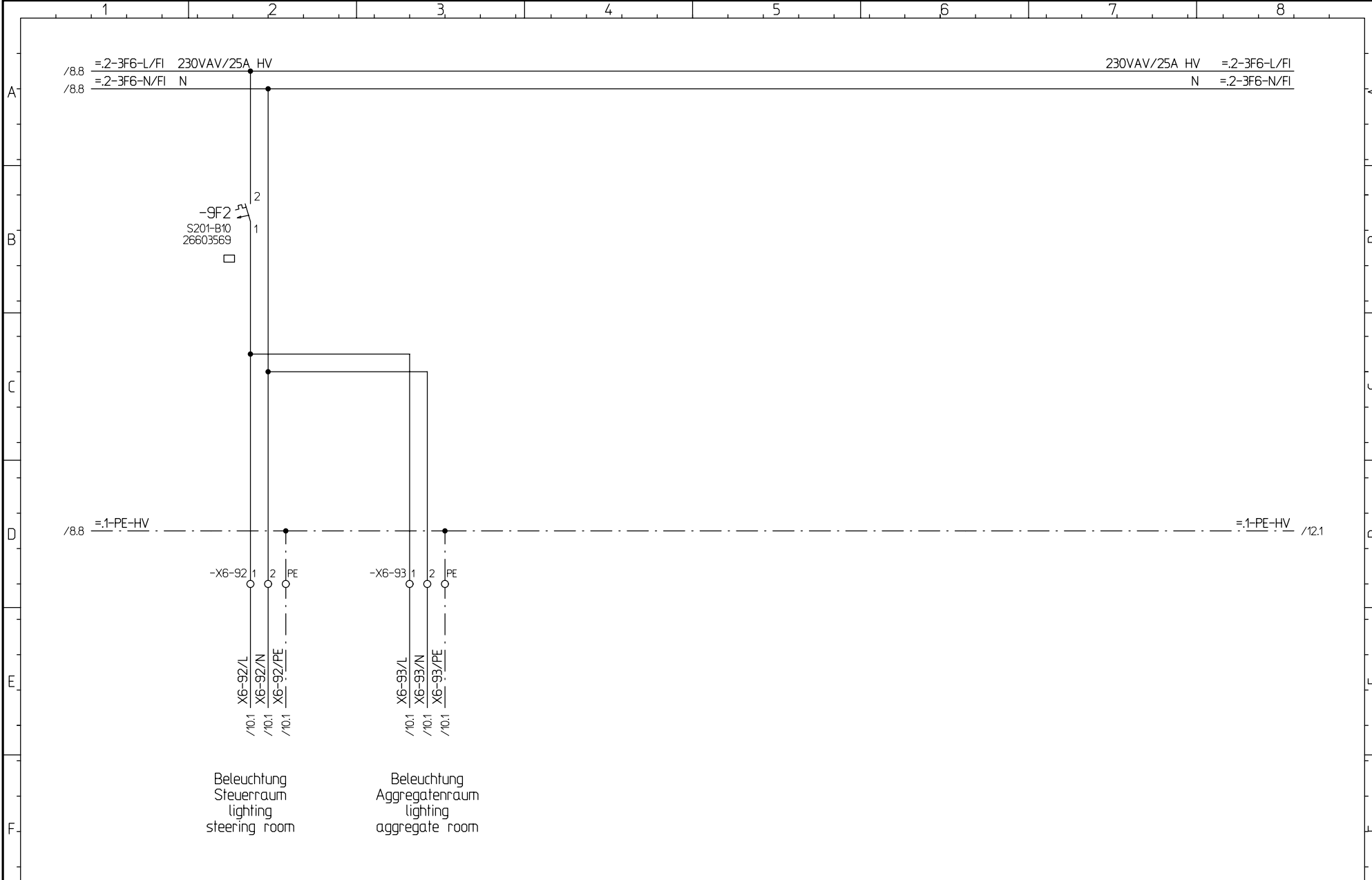

			CAD! KEINE MANUELLEN AENDERUNGEN! CAD! DONT CHANGE MANUAL		Projekt: M-1642-C =Container		Beleuchtung Container light container Installation (Ventilation,Sockets,Light)		Stueckliste: parts list: 25186184		Fg.-Gruppe: funct.-group: .6		Blatt-Nr.: page-nr.: 9			
			Ausdruck-Datum: printout-date: 14.12.11		Herrenknecht AG Schlehenweg 2 D-77963 Schwanau 2 Tel.: 07824 302-0 Fax.: 07824 3403 Info@Herrenknecht.de		Zn.-Nr.: drawn-nr.: 3478-562-002-6		Hauptverteilung main distribution board +HV/MDB		Datum: date: 26.08.2011		Bearb.: name: Th		letzte Aenderung: last modification: IB-Revision 14.12.11 Th	
Index Index			Änderung-Nr. Change No.:			Datum / Name date / name			Blatt-Global: page-global: 49/166			von from 12				

Patent-, Gebrauchsmuster- oder Geschmacksmuster-Eintragung vorbehalten. of a patent, utility model or design.
 ausdrücklich gestattet. Zuwiderhandlungen verpflichten zu Schadenersatz. Alle Rechte fuer den Fall der Auhorisation is prohibited. Offenders will be held liable for the payment of damages. All rights reserved in the event of the grant
 Weitergabe sowie Vervielfaeltigung dieses Dokuments, Verwertung und Mitteilung seines Inhalts sind verboten, soweit nicht The reproduction, distribution and utilization of this document as well as the communication of its contents to others without express

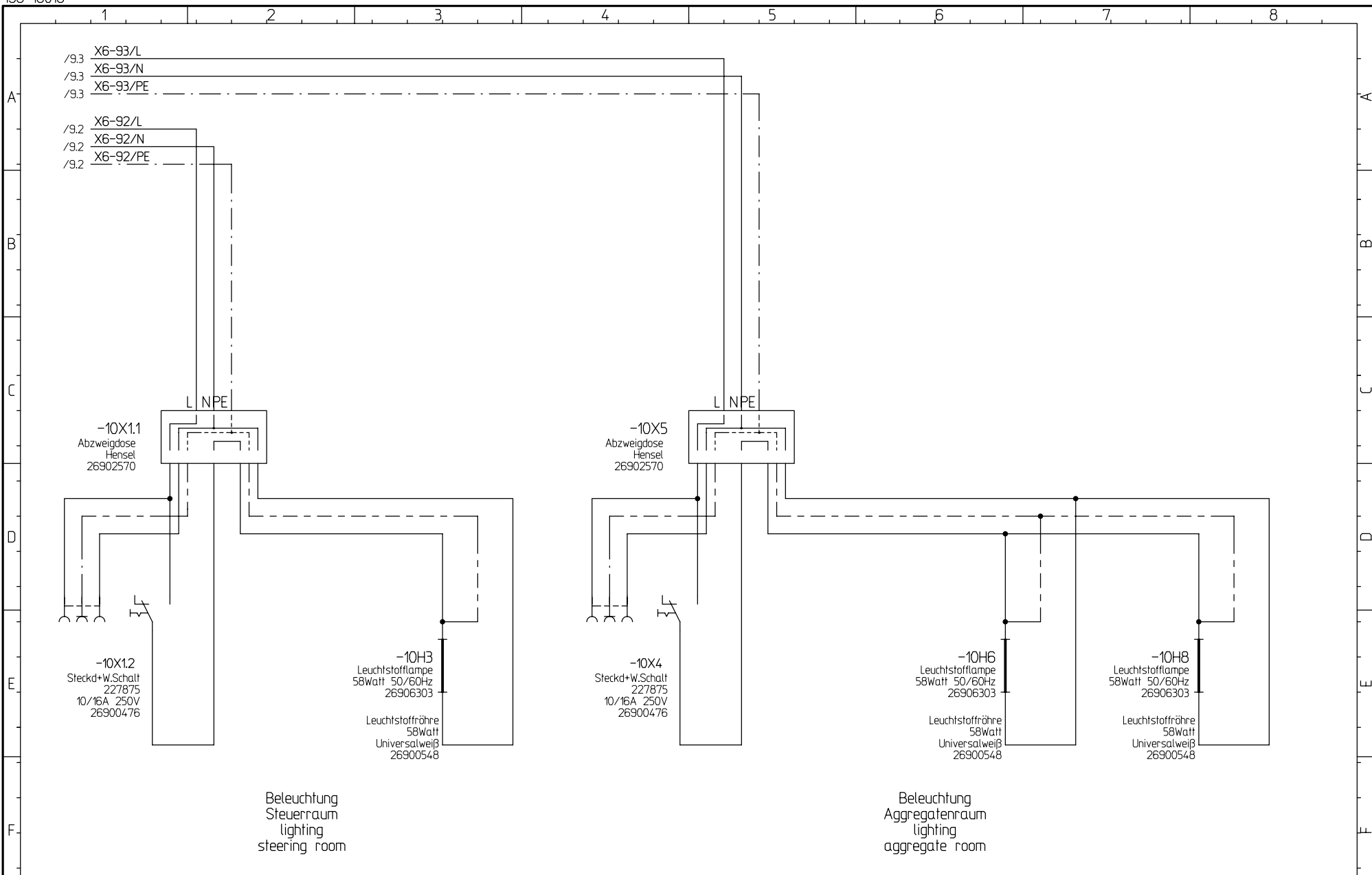

Beleuchtung
Steuerungszimmer
lighting
steering room

Beleuchtung
Aggregatenraum
lighting
aggregate room

			CAD! KEINE MANUELLEN AENDERUNGEN! CAD! DONT CHANGE MANUAL	 Herrenknecht AG Schlehenweg 2 D-77963 Schwanau 2 Tel.: 07824 302-0 Fax.: 07824 3403 Info@Herrenknecht.de	Projekt: project: M-1642-C	Beleuchtung Container light container		Stueckliste: parts list: 25186184	Fg.-Gruppe: funct.-group: .6	Blatt-Nr.: page-nr.: 10
			Ausdruck-Datum: printout-date: 14.12.11		=Container	Installation (Ventilation, Sockets, Light)			Blatt-Global: page-global: 50/166	von from 12
Index Index	Aenderung-Nr. Change No.:	Datum / Name date / name			Zn.-Nr.: drawn-nr.: 3478-562-002-6	Material Container material container +Con	Datum: date: 26.08.2011	Bearb.: name: Th	letzte Aenderung: last modification: IB-Revision 14.12.11 Th	

Weitergabe sowie Vervielfältigung dieses Dokuments, Verwertung und Mitteilung seines Inhalts sind verboten, soweit nicht
 The reproduction, distribution and utilization of this document as well as the communication of its contents to others without express

			CAD! KEINE MANUELLEN ÄNDERUNGEN! CAD! DONT CHANGE MANUAL	 Herrenknecht AG Schlehenweg 2 D-77963 Schwanau 2 Tel.: 07824 302-0 Fax.: 07824 3403 Info@Herrenknecht.de	Projekt: project: M-1642-C	Reserve reserve	Stueckliste: parts list: 25186184	Fg.-Gruppe: funct.-group: .6	Blatt-Nr.: page-nr.: 11	
Index Index	Änderung-Nr. Change No.:	Datum / Name date / name	Ausdruck-Datum: printout-date: 14.12.11		=Container	Zn.-Nr.: drawn-nr.: 3478-562-002-6	Datum: date: 26.08.2011	Bearb.: name: Th	letzte Änderung: last modification: 14.12.11 Th	Blatt-Global: page-global: 51/166

Patent-, Gebrauchsmuster- oder
 Geschmacksmuster-Eintragung vorbehalten.
 of a patent, utility model or design.

ausdrücklich gestattet. Zuwiderhandlungen verpflichten
 zu Schadensersatz. Alle Rechte fuer den Fall der
 authorisation is prohibited. Offenders will be held liable for the
 payment of damages. All rights reserved in the event of the grant

Patent-, Gebrauchsmuster- oder Geschmacksmuster-Eintragung vorbehalten.
 of a patent, utility model or design.
 ausdrucklich gestattet. Zuwiderhandlungen verpflichten zu Schadenersatz. Alle Rechte fuer den Fall der Auhorisation is prohibited. Offenders will be held liable for the payment of damages. All rights reserved in the event of the grant
 Weitergabe sowie Vervielfaeltigung dieses Dokuments, Verwertung und Mitteilung seines Inhalts sind verboten, soweit nicht The reproduction, distribution and utilization of this document as well as the communication of its contents to others without express

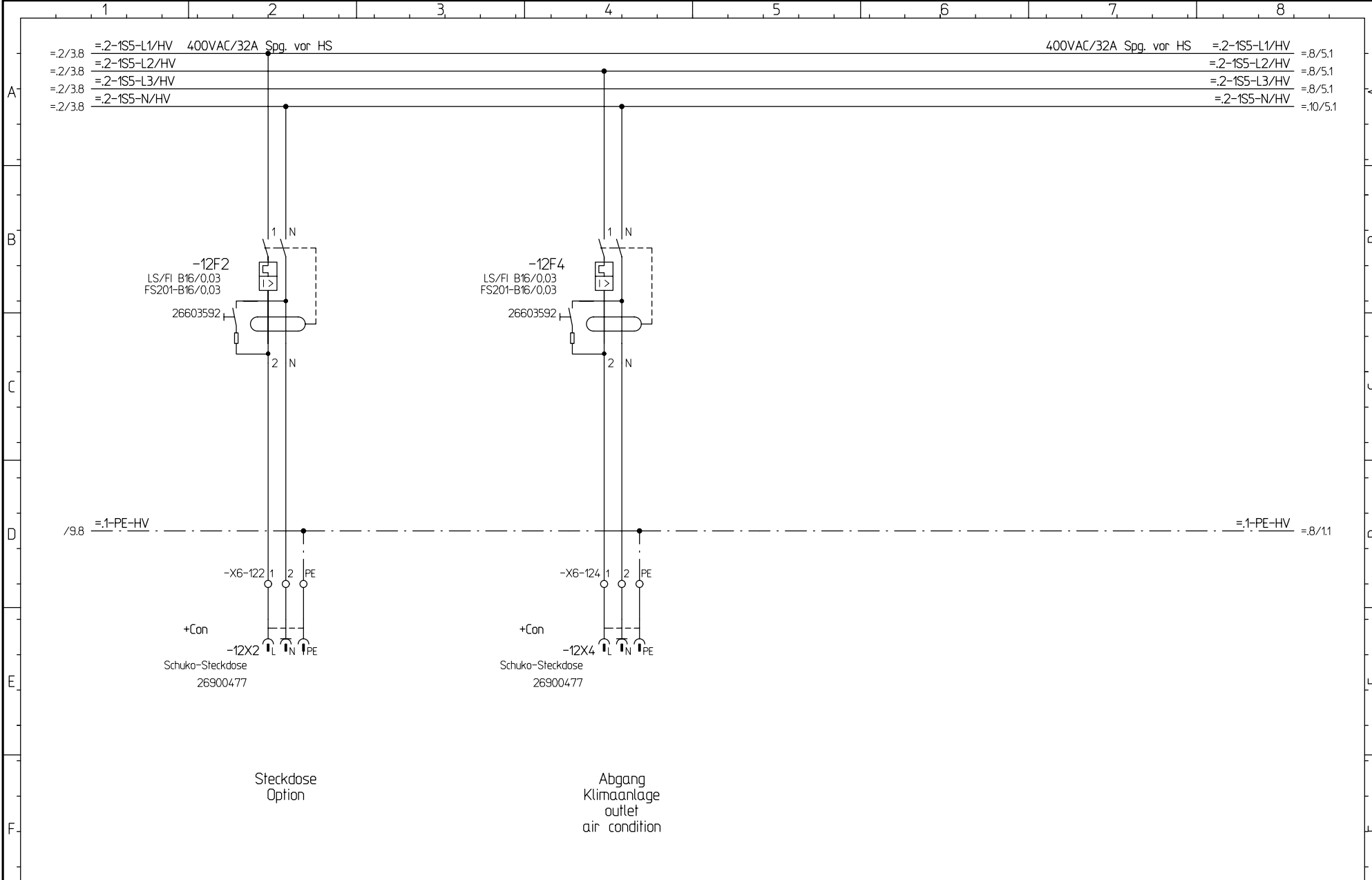

CAD! KEINE MANUELLEN AENDERUNGEN! CAD! DONT CHANGE MANUAL			 Herrenknecht AG Schlehenweg 2 D-77963 Schwanau 2 Tel.: 07824 302-0 Fax.: 07824 3403 Info@Herrenknecht.de	Projekt: M-1642-C =Container		Heizung/Klimaanlage Steuerraum heating/air condition steering room Installation (Ventilation,Sockets,Light)		Stueckliste: parts list: 25186184		Fg.-Gruppe: funct.-group: .6		Blatt-Nr.: page-nr.: 12				
Ausdruck-Datum: printout-date: 14.12.11				Zn.-Nr.: drawn-nr.: 3478-562-002-6		Hauptverteilung main distribution board +HV/MDB		Datum: date: 26.08.2011		Bearb.: name: Th		letzte Aenderung: last modification: IB-Revision 14.12.11 Th		Blatt-Global: page-global: 52/166		von from 12

Patent-, Gebrauchsmuster- oder
 Geschmacksmuster-Eintragung vorbehalten.
 of a patent, utility model or design.

ausdrücklich gestattet. Zuwiderhandlungen verpflichten
 zu Schadenersatz. Alle Rechte fuer den Fall der
 authorization is prohibited. Offenders will be held liable for the
 payment of damages. All rights reserved in the event of the grant

Weitergabe sowie Vervielfaeltigung dieses Dokuments, Verwertung
 und Mitteilung seines Inhalts sind verboten, soweit nicht
 The reproduction, distribution and utilization of this document as
 well as the communication of its contents to others without express

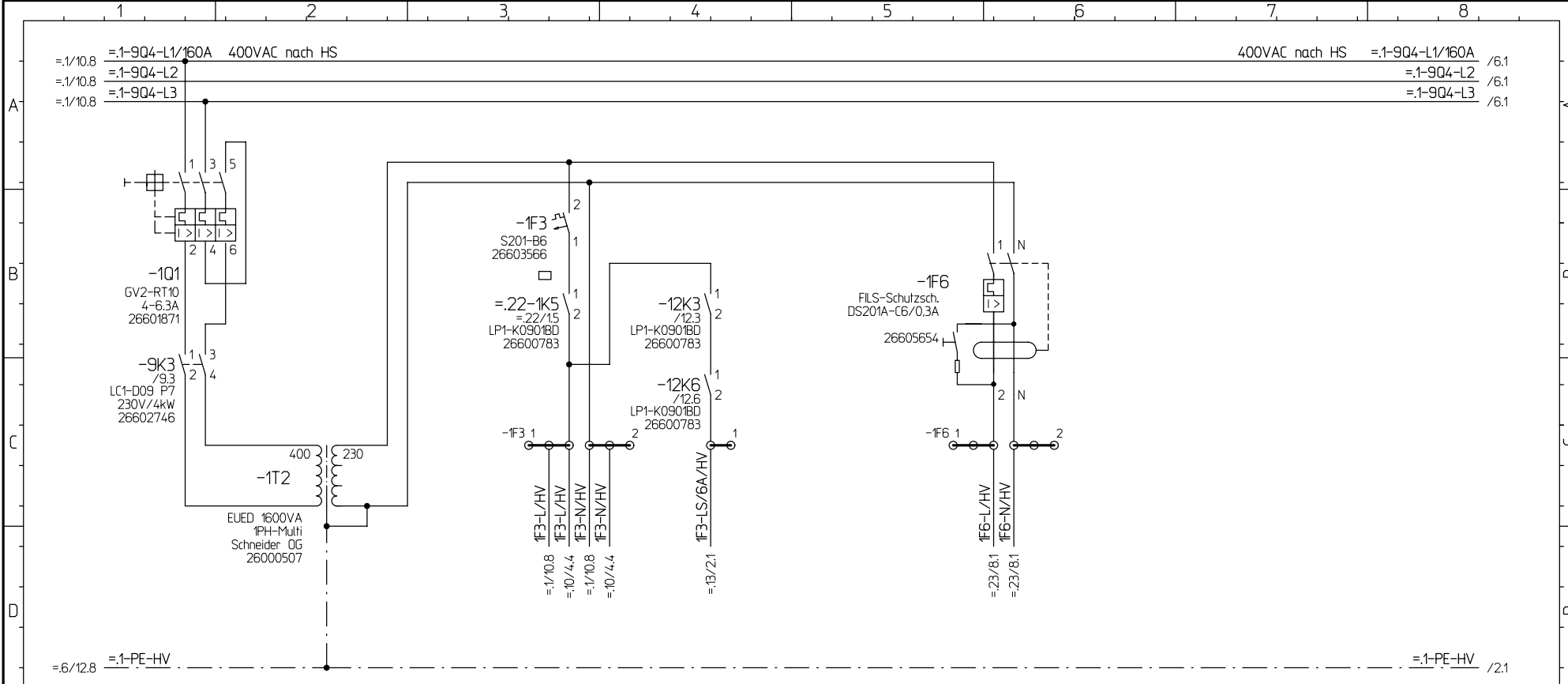

Steuerspannung
 Schütze
 Hauptverteilung
 control voltage
 contactors
 main distribution

230VAC zu
 Bentonitschmierung
 230VAC to
 bentonite lubrication

			CAD! KEINE MANUELLEN AENDERUNGEN! CAD! DONT CHANGE MANUAL		Projekt: project: M-1642-C		Steuerspannung 230VAC nach Hauptschalter control voltage 230VAC behind main switch		Stueckliste: parts list: 25186184		Fg.-Gruppe: funct.-group: .8		Blatt-Nr.: page-nr.: 1	
			Ausdruck-Datum: printout-date: 14.12.11		=Container		Steuerspannung / control voltage				Blatt-Global: page-global: 53/166		von from 12	
Index	Änderung-Nr. Change No.:	Datum / Name date / name	 Herrenknecht AG Schlehenweg 2 D-77963 Schwanau 2 Tel.: 07824 302-0 Fax.: 07824 3403 Info@Herrenknecht.de			Zn.-Nr. drawn-nr.:	Hauptverteilung main distribution board +HV/MDB		Datum: date:	Bearb. name:	letzte Änderung: last modification:		IB-Revision 14.12.11 Th	
Index						3478-562-002-8	26.08.2011	Th						

Patent-, Gebrauchsmuster- oder Geschmacksmuster-Eintragung vorbehalten. of a patent, utility model or design.

ausdrücklich gestattet. Zuwiderhandlungen verpflichten zu Schadenersatz. Alle Rechte für den Fall der Auhonization is prohibited. Offenders will be held liable for the payment of damages. All rights reserved in the event of the grant

Weitergabe sowie Vervielfältigung dieses Dokuments, Verwertung und Mitteilung seines Inhalts sind verboten, soweit nicht The reproduction, distribution and utilization of this document as well as the communication of its contents to others without express

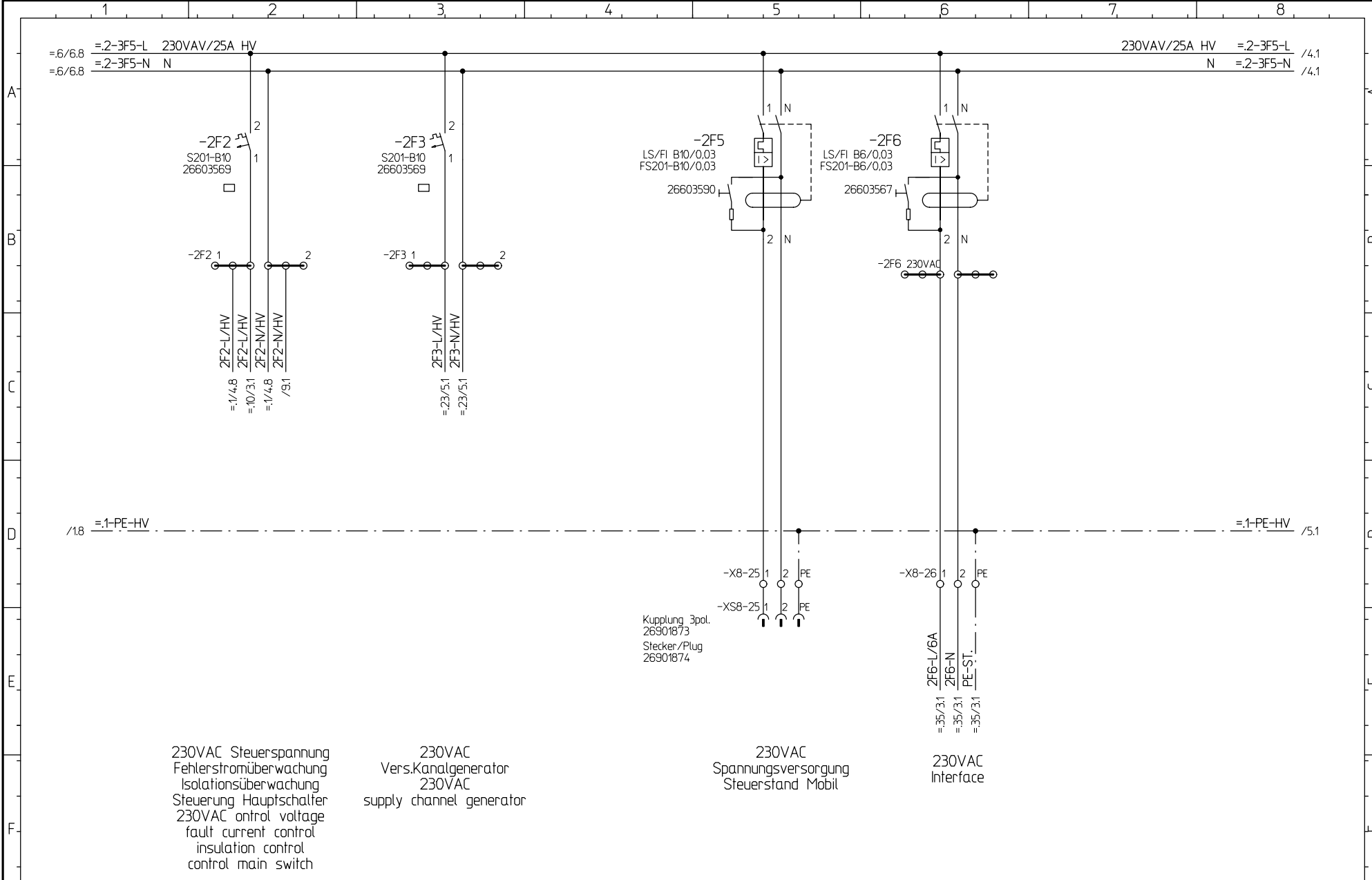

230VAC Steuerspannung
Fehlerstromüberwachung
Isolationsüberwachung
Steuerung Hauptschalter
230VAC onrtrol voltage
fault current control
insulation control
control main switch

230VAC
Vers.Kanalgenerator
230VAC
supply channel generator

230VAC
Spannungsversorgung
Steuerstand Mobil

230VAC
Interface

<p>CAD! KEINE MANUELLEN AENDERUNGEN! CAD! DONT CHANGE MANUAL</p>			 <p>Herrenknecht AG Schlehenweg 2 D-77963 Schwanaau 2 Tel.: 07824 302-0 Fax.: 07824 3403 Info@Herrenknecht.de</p>	<p>Projekt: M-1642-C =Container</p>		<p>Steuerspannung 230VAC vor Hauptschalter control voltage 230VAC before main switch</p>		<p>Stueckliste: parts list: 25186184</p>		<p>Fg.-Gruppe: funct.-group: .8</p>		<p>Blatt-Nr.: page-nr.: 2</p>				
<p>Ausdruck-Datum: printout-date: 14.12.11</p>				<p>Zn.-Nr.: drawn-nr.: 3478-562-002-8</p>		<p>Hauptverteilung main distribution board +HV/ MDB</p>		<p>Datum: date: 26.08.2011</p>		<p>Bearb. name: Th</p>		<p>letzte Aenderung: last modification: 1B-Revision 14.12.11 Th</p>		<p>Blatt-Global: page-global: 54/166</p>		<p>von from 12</p>

Weitergabe sowie Vervielfältigung dieses Dokuments, Verwertung
 und Mitteilung seines Inhalts sind verboten, soweit nicht
 The reproduction, distribution and utilization of this document as
 well as the communication of its contents to others without express
 ausdruecklich gestattet. Zuwiderhandlungen verpflichten
 zu Schadensersatz. Alle Rechte fuer den Fall der
 authorization is prohibited. Offenders will be held liable for the
 payment of damages. All rights reserved in the event of the grant
 Patent-, Gebrauchsmuster- oder
 Geschmacksmuster-Eintragung vorbehalten.
 of a patent, utility model or design.

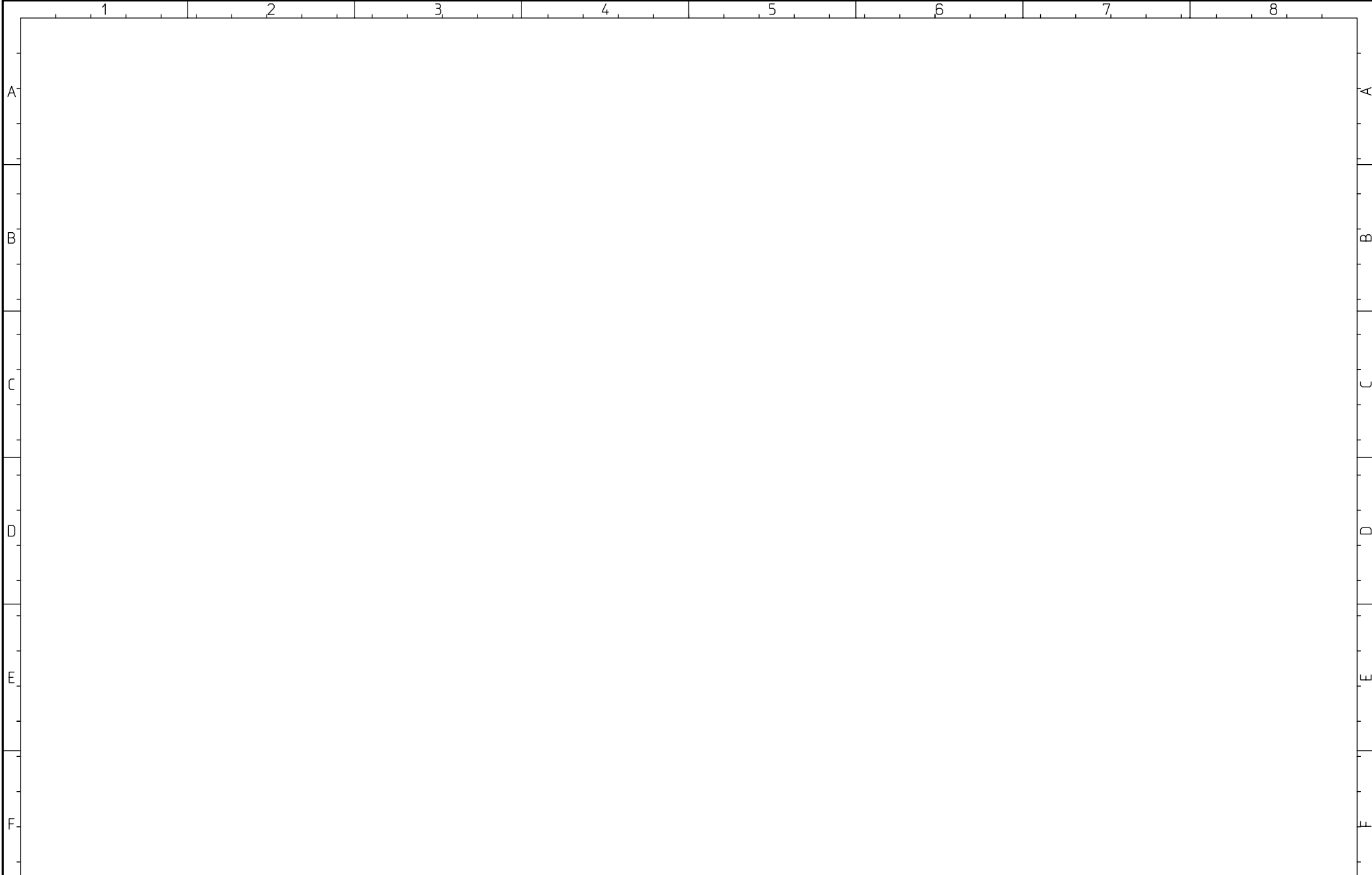

			CAD! KEINE MANUELLEN AENDERUNGEN ! CAD! DONT CHANGE MANUAL	 Herrenknecht AG Schlehenweg 2 D-77963 Schwanau 2 Tel.: 07824 302-0 Fax.: 07824 3403 Info@Herrenknecht.de	Projekt: project: M-1642-C	Reserve reserve Steuerspannung / control voltage	Stueckliste: parts list: 25186184	Fg.-Gruppe: funct.-group: .8	Blatt-Nr.: page-nr.: 3
Index Index	Änderung-Nr. Change No.:	Datum / Name date / name	Ausdruck-Datum: printout-date: 14.12.11		Zn.-Nr.: drawn-nr.: 3478-562-002-8	Datum: date: 26.08.2011	Bearb.: name: Th	letzte Aenderung: last modification: IB-Revision 14.12.11 Th	Blatt-Global: page-global: 55/166

Patent-, Gebrauchsmuster- oder Geschmacksmuster-Eintragung vorbehalten. of a patent, utility model or design.

ausdrücklich gestattet. Zuwiderhandlungen verpflichten zu Schadenersatz. Alle Rechte fuer den Fall der Auhonisation is prohibited. Offenders will be held liable for the payment of damages. All rights reserved in the event of the grant

Weitergabe sowie Vervielfaeltigung dieses Dokuments, Verwertung und Mitteilung seines Inhalts sind verboten, soweit nicht The reproduction, distribution and utilization of this document as well as the communication of its contents to others without express

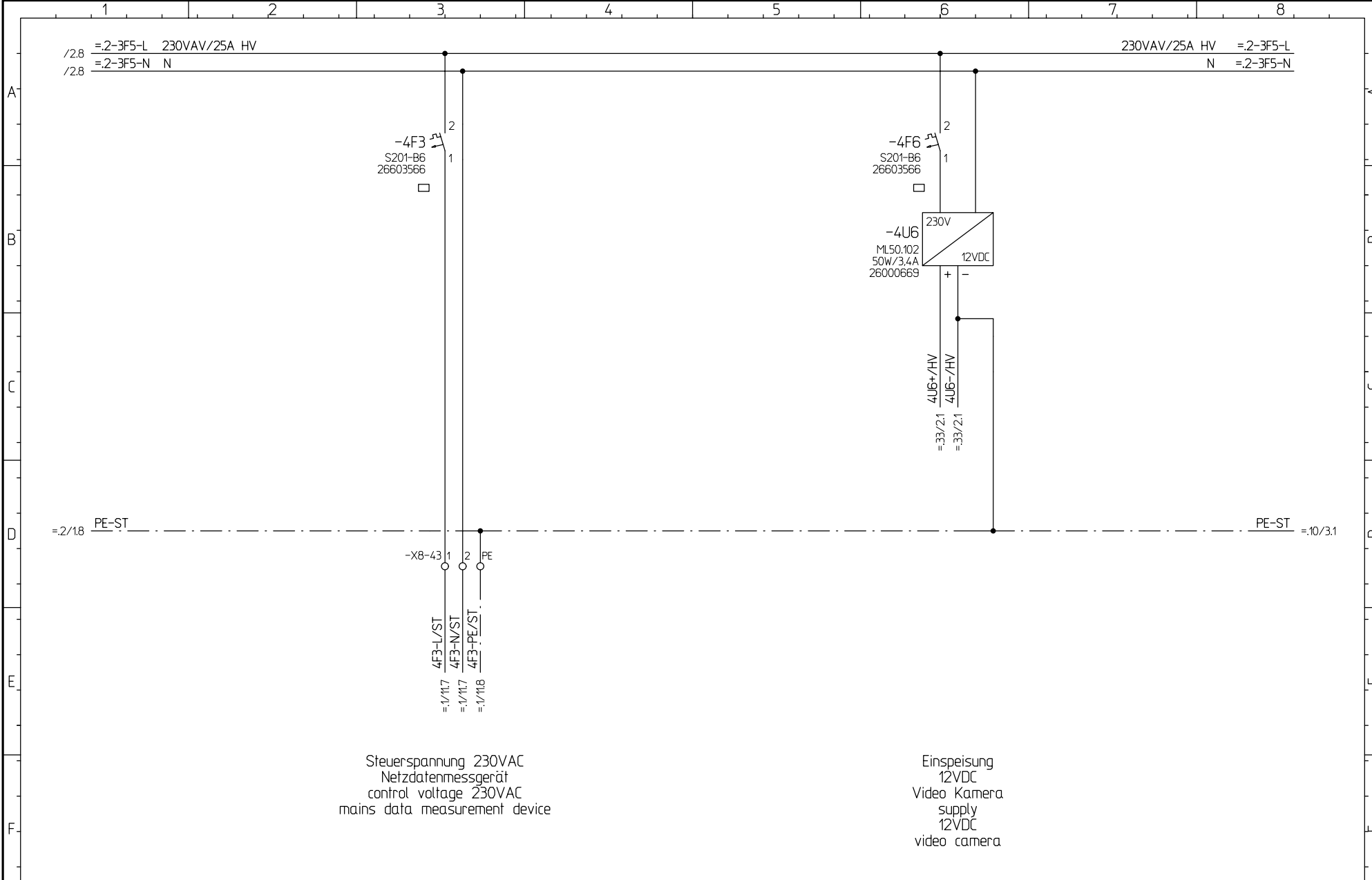

			CAD! KEINE MANUELLEN AENDERUNGEN! CAD! DONT CHANGE MANUAL		Herrenknecht AG Schlehenweg 2 D-77963 Schwanau 2 Tel.: 07824 302-0 Fax.: 07824 3403 Info@Herrenknecht.de		Projekt: M-1642-C =Container		Steuerspannung 230VAC vor Hauptschalter control voltage 230VAC before main switch		Stueckliste: parts list: 25186184		Fg.-Gruppe: funct.-group: .8		Blatt-Nr.: page-nr.: 4	
			Ausdruck-Datum: printout-date: 14.12.11				Zn.-Nr.: drawn-nr.: 3478-562-002-8		Hauptverteilung main distribution board +HV/MDB		Datum: date: 26.08.2011		Bearb.: name: Th		letzte Aenderung: last modification: IB-Revision 14.12.11 Th	
													Blatt-Global: page-global: 56/166		von from 12	

Patent-, Gebrauchsmuster- oder
 Geschmacksmuster-Eintragung vorbehalten.
 of a patent, utility model or design.

ausdrucklich gestattet. Zuwiderhandlungen verpflichten
 zu Schadensersatz. Alle Rechte fuer den Fall der
 authorization is prohibited. Offenders will be held liable for the
 payment of damages. All rights reserved in the event of the grant

Weitergabe sowie Vervielfaeltigung dieses Dokuments, Verwertung
 und Mitteilung seines Inhalts sind verboten, soweit nicht
 The reproduction, distribution and utilization of this document as
 well as the communication of its contents to others without express

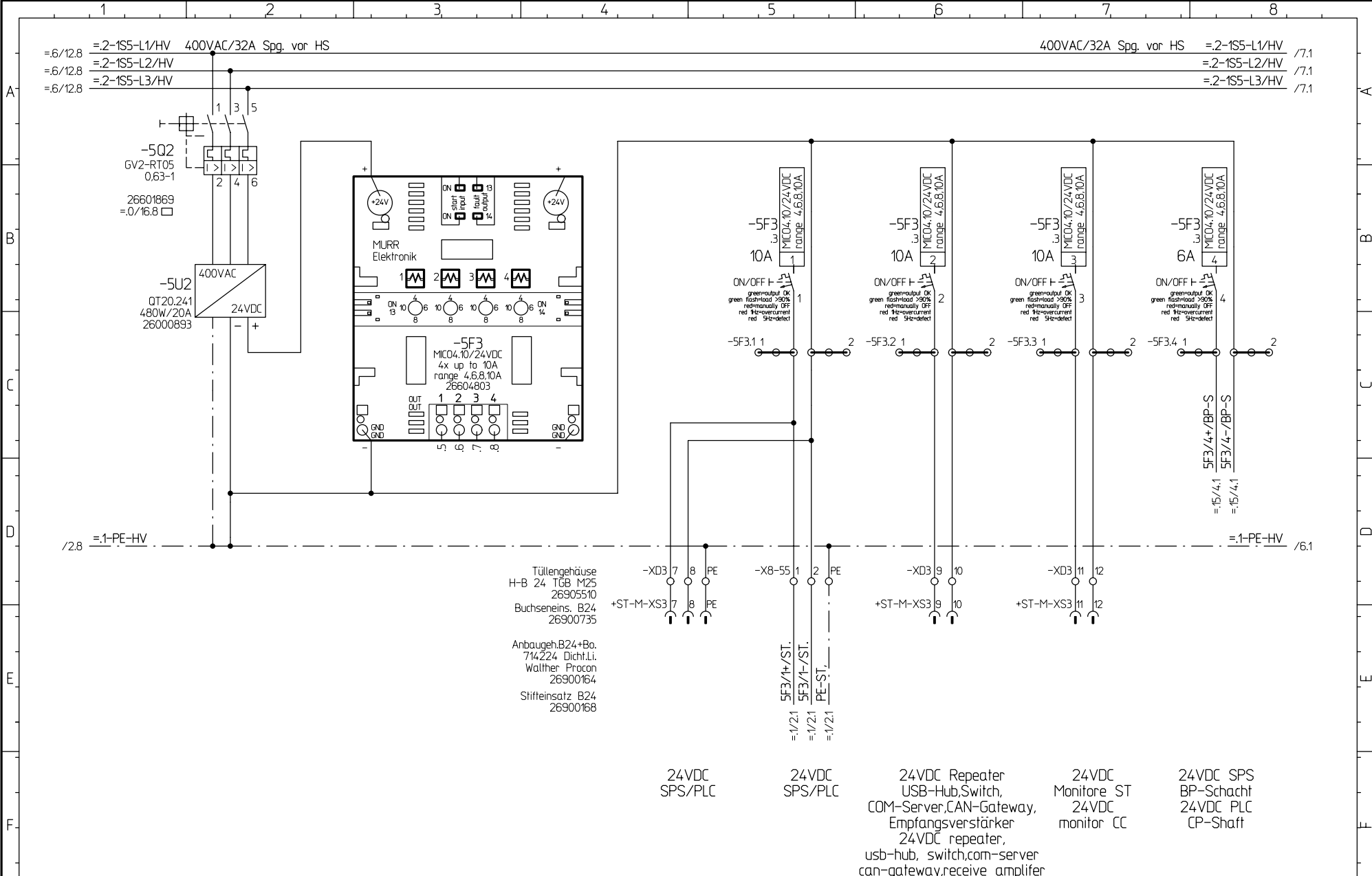

Index	Änderung-Nr. Change No.:	Datum / Name date / name	CAD! KEINE MANUELLEN ÄNDERUNGEN! CAD! DONT CHANGE MANUAL	Herrenknecht AG Schlehenweg 2 D-77963 Schwanaau 2 Tel.: 07824 302-0 Fax.: 07824 3403 Info@Herrenknecht.de	Projekt: project:	M-1642-C	Steuerspannung 24VDC vor Hauptschalter control voltage 24VDC before main switch	Stueckliste: parts list:	Fg.-Gruppe: func.-group:	Blatt-Nr.: page-nr.:							
			Ausdruck-Datum: printout-date:		14.12.11	=Container	Steuerspannung / control voltage	25186184	.8	5							
Index	Änderung-Nr. Change No.:	Datum / Name date / name	14.12.11			Zn.-Nr.: drawn-nr.:	3478-562-002-8	Hauptverteilung main distribution board +HV/MBB	Datum: date:	26.08.2011	Bearb.: name:	Th	letzte Änderung: last modification:	IB-Revision 14.12.11 Th	Blatt-Global: page-global:	57/166	von from

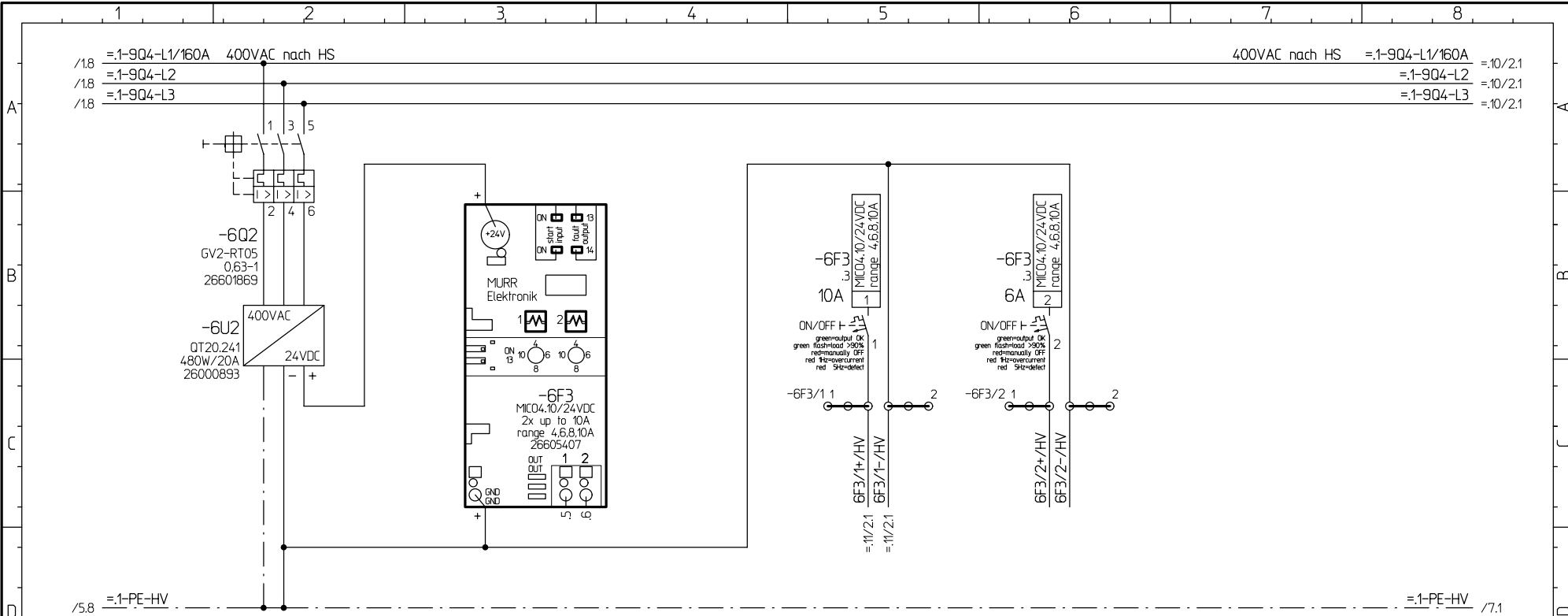

24VDC
Ventile
Vortriebspresen
24VDC
valves
thrust cylinders

24VDC
Reserve
24VDC
Reserve

			CAD! KEINE MANUELLEN AENDERUNGEN! CAD! DONT CHANGE MANUAL	 Herrenknecht AG Schleheweg 2 D-77963 Schwanaau 2 Tel.: 07824 302-0 Fax.: 07824 3403 Info@Herrenknecht.de	Projekt: project: M-1642-C	Steuerspannung 24VDC Ventile control voltage 24VDC valves		Stueckliste: parts list: 25186184	Fg.-Gruppe: funct.-group: .8	Blatt-Nr.: page-nr.: 6		
Index Index	Aenderung-Nr. Change No.:	Datum / Name date / name	Ausdruck-Datum: printout-date: 14.12.11		=Container	Steuerspannung / control voltage		Hauptverteilung main distribution board +HV/MDB	Datum: date: 26.08.2011	Bearb. name: Th	letzte Aenderung: last modification: IB-Revision 14.12.11 Th	Blatt-Global: page-global: 58/166

Patent-, Gebrauchsmuster- oder
 Geschmacksmuster-Eintragung vorbehalten.
 of a patent, utility model or design.

ausdrücklich gestattet. Zuwiderhandlungen verpflichten
 zu Schadenersatz. Alle Rechte fuer den Fall der
 authorisation is prohibited. Offenders will be held liable for the
 payment of damages. All rights reserved in the event of the grant

Weitergabe sowie Vervielfaeltigung dieses Dokuments, Verwertung
 und Mitteilung seines Inhalts sind verboten, soweit nicht
 The reproduction, distribution and utilization of this document as
 well as the communication of its contents to others without express

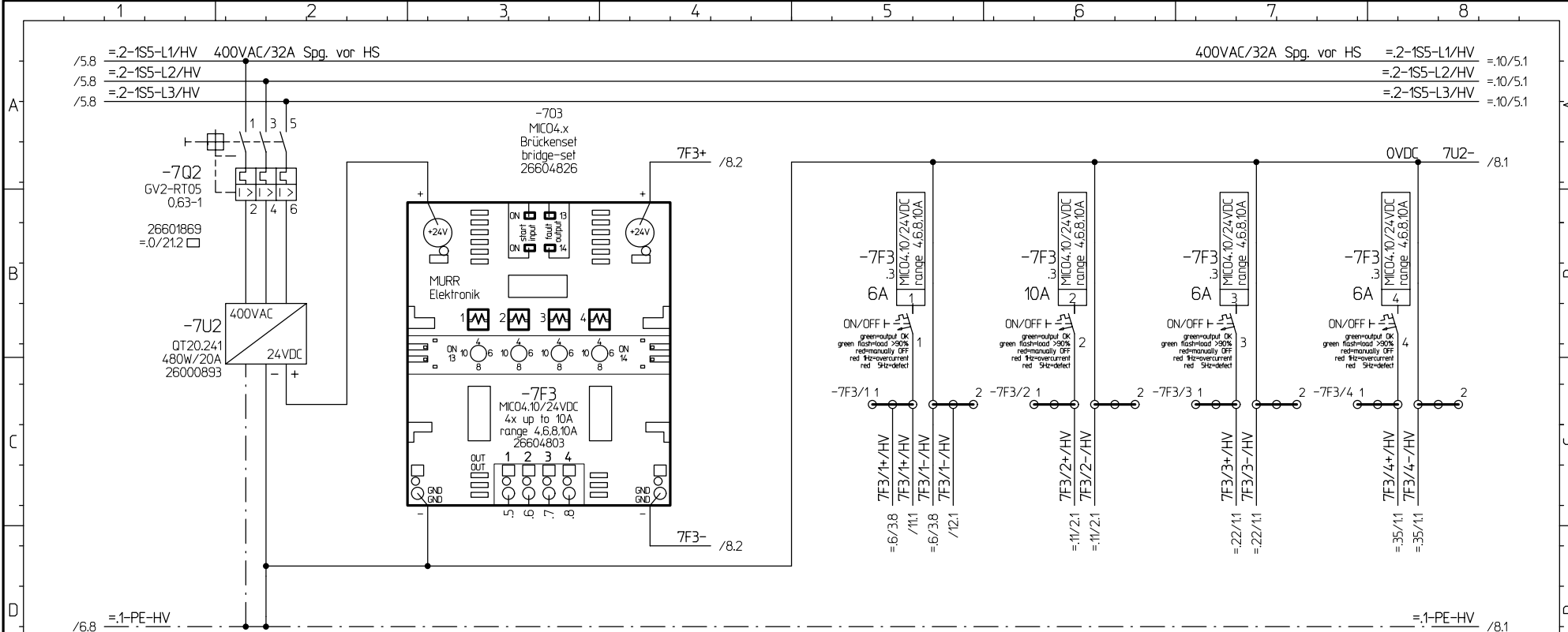

24VDC SPS Hauptverteilung
 24VDC PLC main distribution

24VDC SPS XD40 Aggregat
 24VDC PLC XD40 aggregate

24VDC Not-Aus

24VDC Divers

CAD! KEINE MANUELLEN AENDERUNGEN! CAD! DONT CHANGE MANUAL			 Herrenknecht AG Schleheweg 2 D-77963 Schwanau 2 Tel.: 07824 302-0 Fax: 07824 3403 Info@Herrenknecht.de	Projekt: M-1642-C =Container		Steuerspannung 24VDC vor Hauptschalter control voltage 24VDC before main switch		Stueckliste: parts list: 25186184		Fg.-Gruppe: funct.-group: .8		Blatt-Nr.: page-nr.: 7		
Ausdruck-Datum: printout-date: 14.12.11				Zn.-Nr.: drawn-nr.: 3478-562-002-8		Steuerspannung / control voltage		Hauptverteilung main distribution board +HV/MB		Datum: date: 26.08.2011		Bearb.: name: Th		letzte Aenderung: last modification: IB-Revision 14.12.11 Th

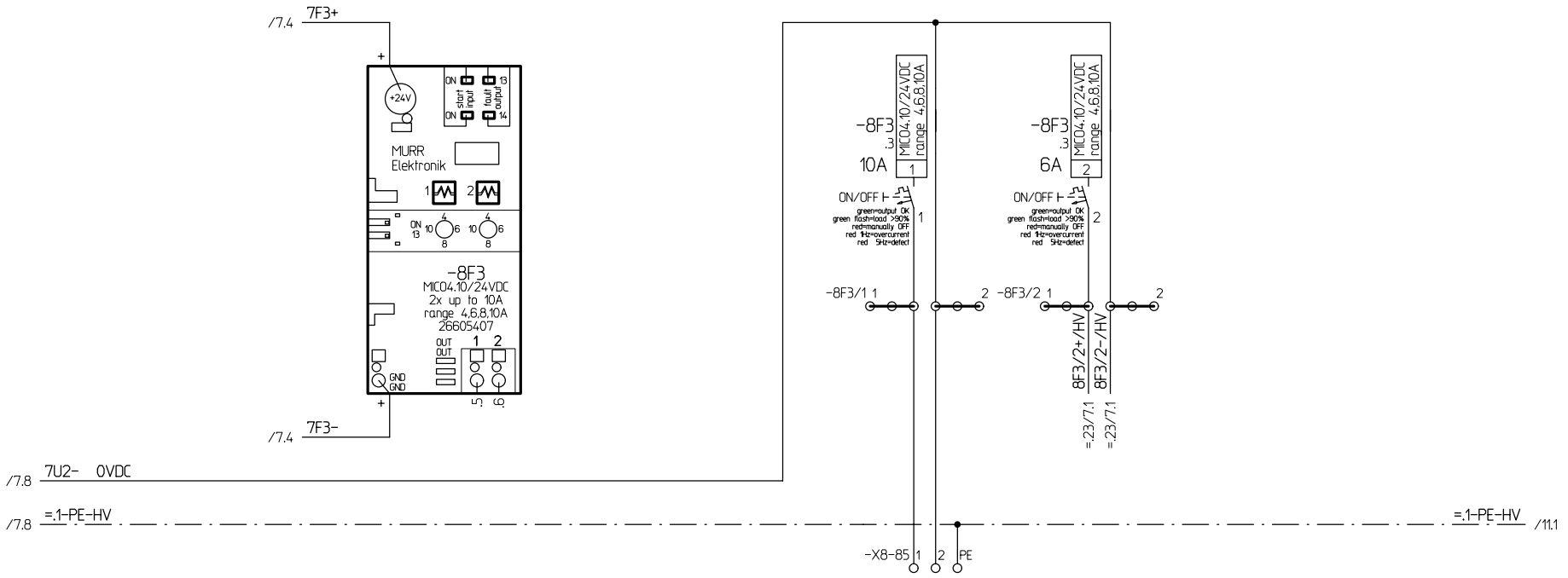

			CAD! KEINE MANUELLEN AENDERUNGEN! CAD! DONT CHANGE MANUAL	 Herrenknecht AG Schleheweg 2 D-77963 Schwanaau 2 Tel.: 07824 302-0 Fax.: 07824 3403 Info@Herrenknecht.de	Projekt: project: M-1642-C	Steuerspannung 24VDC vor Hauptschalter control voltage 24VDC before main switch	Stueckliste: parts list: 25186184	Fg.-Gruppe: funct.-group: .8	Blatt-Nr.: page-nr.: 8		
Index Index	Aenderung-Nr. Change No.:	Datum / Name date / name	Ausdruck-Datum: printout-date: 14.12.11		=Container	Steuerspannung / control voltage	Hauptverteilung main distribution board +HV/MDB	Datum: date: 26.08.2011	Bearb.: name: Th	letzte Aenderung: last modification: IB-Revision 14.12.11 Th	Blatt-Global: page-global: 60/166

Patent-, Gebrauchsmuster- oder Geschmacksmuster-Eintragung vorbehalten.
 of a patent, utility model or design.
 ausdrücklich gestattet. Zuwiderhandlungen verpflichten zu Schadenersatz. Alle Rechte für den Fall der autorisation is prohibited. Offenders will be held liable for the payment of damages. All rights reserved in the event of the grant
 Weitergabe sowie Vervielfältigung dieses Dokuments, Verwertung und Mitteilung seines Inhalts sind verboten, soweit nicht The reproduction, distribution and utilization of this document as well as the communication of its contents to others without express

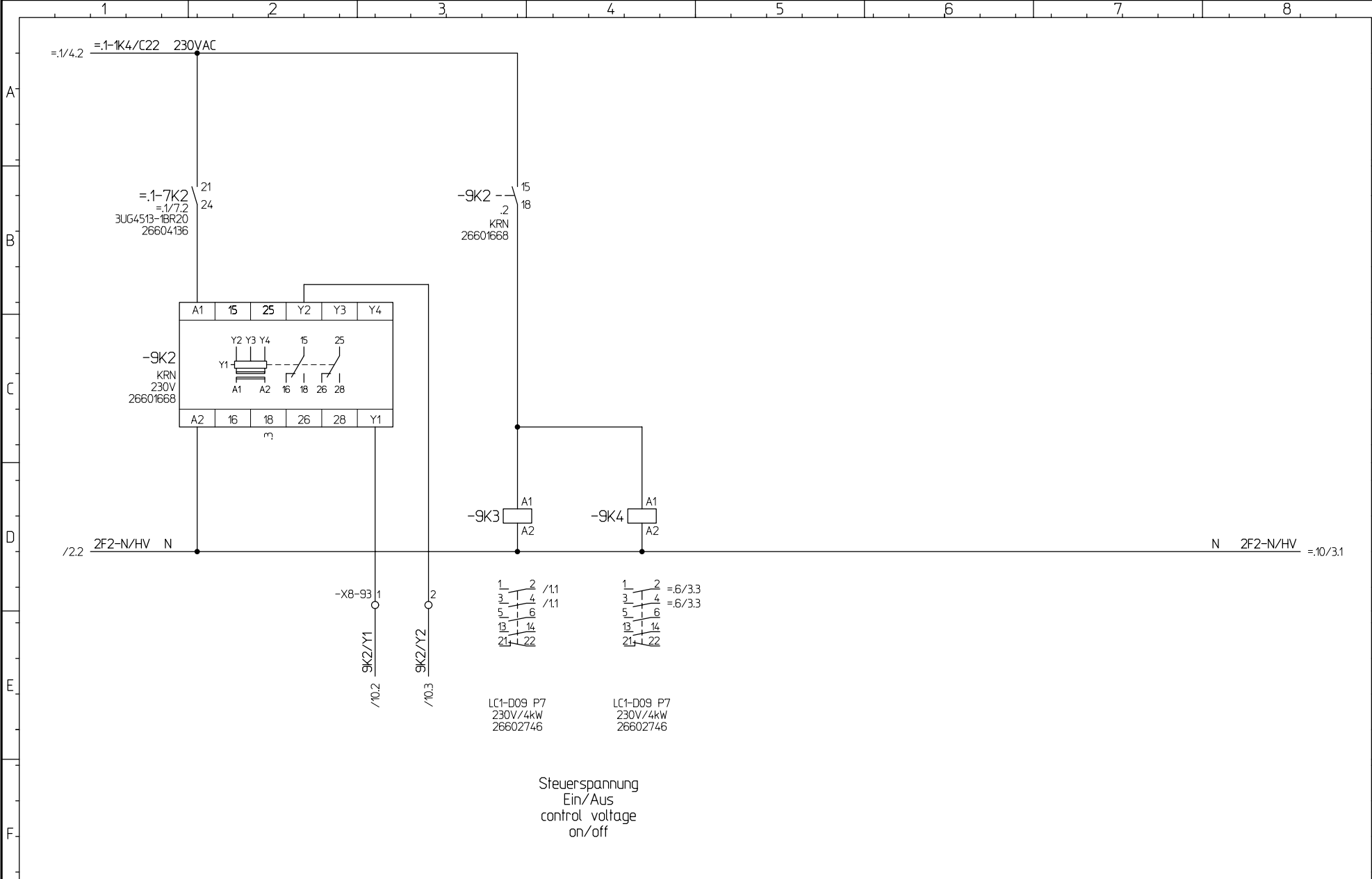

			CAD! KEINE MANUELLEN AENDERUNGEN! CAD! DONT CHANGE MANUAL		Herrenknecht AG Schlehenweg 2 D-77963 Schwanau 2 Tel.: 07824 302-0 Fax.: 07824 3403 Info@Herrenknecht.de		Projekt: project: M-1642-C =Container		Steuerung Ein/Aus control on/off Steuerspannung / control voltage		Stueckliste: parts list: 25186184		Fg.-Gruppe: funct.-group: .8		Blatt-Nr.: page-nr.: 9	
			Ausdruck-Datum: printout-date: 14.12.11				Zn.-Nr.: drawn-nr.: 3478-562-002-8		Hauptverteilung main distribution board +HV/MBB		Datum: date: 26.08.2011		Bearb.: name: Th		letzte Aenderung: last modification: IB-Revision 14.12.11 Th	
Index Index			Änderung-Nr. Change No.:												Blatt-Global: page-global: 61/166	

Patent-, Gebrauchsmuster- oder Geschmacksmuster-Eintragung vorbehalten. of a patent, utility model or design.
 ausdrücklich gestattet. Zuwiderhandlungen verpflichten zu Schadenersatz. Alle Rechte für den Fall der Autorisation ist prohibited. Offenders will be held liable for the payment of damages. All rights reserved in the event of the grant
 Weitergabe sowie Vervielfältigung dieses Dokuments, Verwertung und Mitteilung seines Inhalts sind verboten, soweit nicht The reproduction, distribution and utilization of this document as well as the communication of its contents to others without express

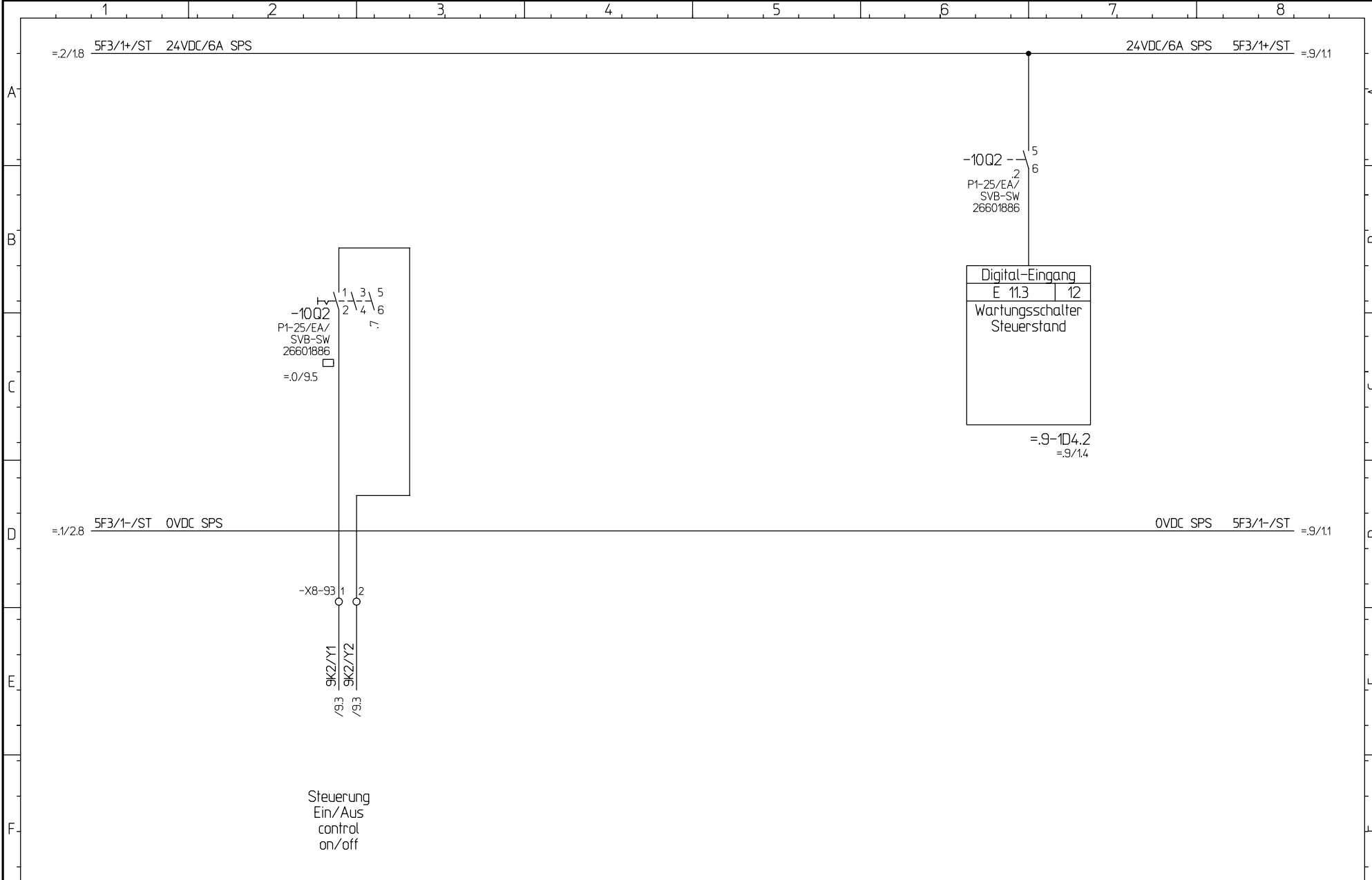

CAD! KEINE MANUELLEN AENDERUNGEN! CAD! DONT CHANGE MANUAL			 Herrenknecht AG Schlehenweg 2 D-77963 Schwanau 2 Tel.: 07824 302-0 Fax.: 07824 3403 Info@Herrenknecht.de	Projekt: M-1642-C =Container		Steuerung Ein/Aus control on/off Steuerspannung / control voltage		Stueckliste: 25186184 Fg.-Gruppe: .8 Blatt-Nr.: 10		
Index Index	Änderung-Nr. Change No.:	Datum / Name date / name		Ausdruck-Datum: printout-date: 14.12.11	Zn.-Nr.: drawn-nr.: 3478-562-002-8	Steuerstand Control Cabin +ST/CC	Datum: date: 26.08.2011	Bearb. name: Th	letzte Änderung: last modification: IB-Revision 14.12.11 Th	Blatt-Global: page-global: 62/166

Patent-, Gebrauchsmuster- oder Geschmacksmuster-Eintragung vorbehalten.
 Patent-, Gebrauchsmuster- oder Geschmacksmuster-Eintragung vorbehalten.
 ausdrucklich gestattet. Zuwiderhandlungen verpflichten zu Schadenersatz. Alle Rechte fuer den Fall der autorization is prohibited. Offenders will be held liable for the payment of damages. All rights reserved in the event of the grant
 Weitergabe sowie Vervielfaeltigung dieses Dokuments, Verwertung und Mitteilung seines Inhalts sind verboten, soweit nicht The reproduction, distribution and utilization of this document as well as the communication of its contents to others without express

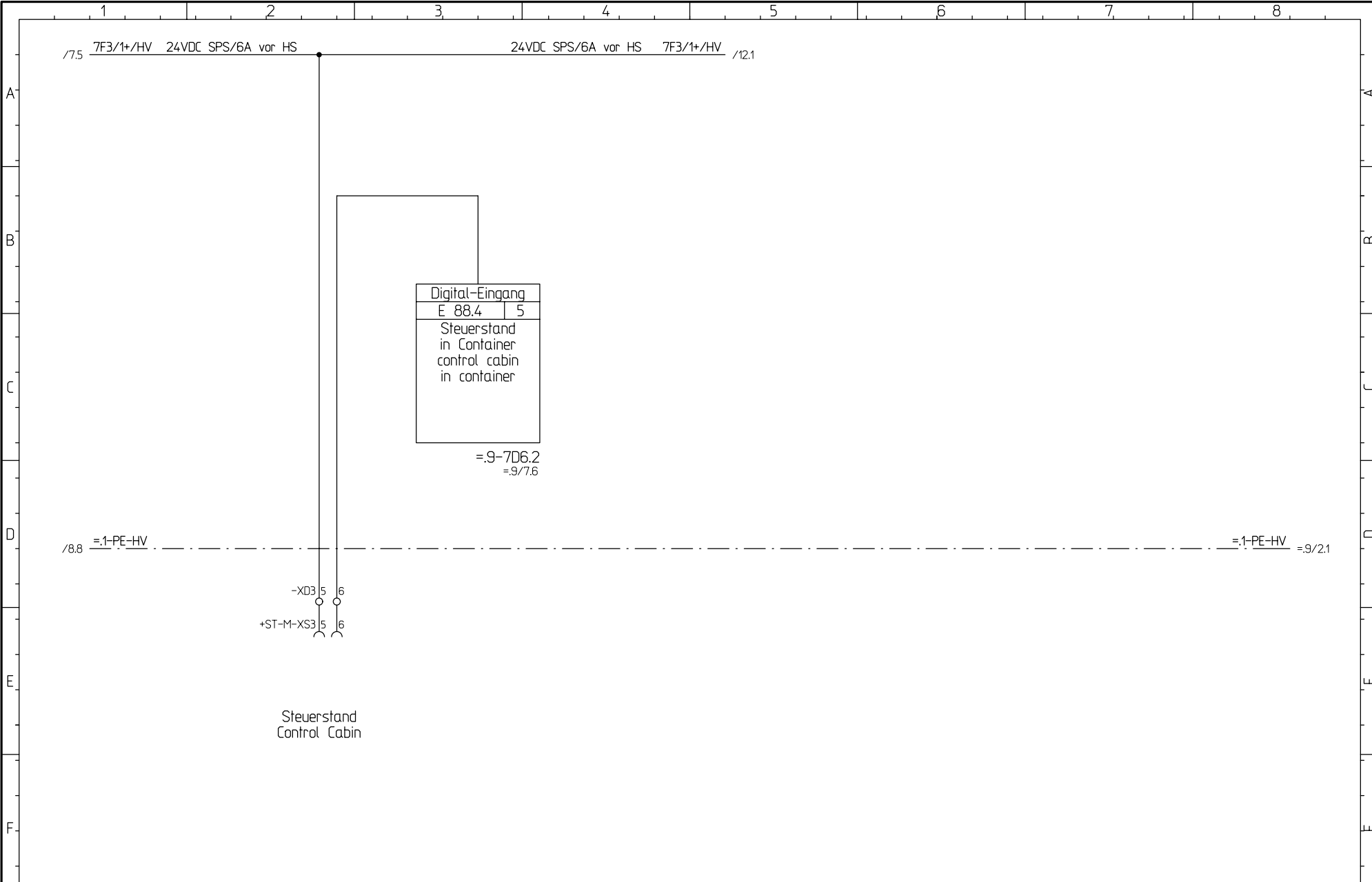

Steuerstand
Control Cabin

Digital-Eingang
E 88.4 5
Steuerstand
in Container
control cabin
in container

=9-7D6.2
=9/7.6

			CAD! KEINE MANUELLEN AENDERUNGEN! CAD! DONT CHANGE MANUAL		 Herrenknecht AG Schlehenweg 2 D-77963 Schwanaau 2 Tel.: 07824 302-0 Fax.: 07824 3403 Info@Herrenknecht.de	Projekt: M-1642-C =Container		Steuerstand in Container control cabin in container Steuerspannung / control voltage		Stueckliste: parts list: 25186184		Fg.-Gruppe: funct.-group: .8		Blatt-Nr.: page-nr.: 11				
Ausdruck-Datum: printout-date: 14.12.11						Zn.-Nr.: drawn-nr.: 3478-562-002-8		Hauptverteilung main distribution board +HV/MDB		Datum: date: 26.08.2011		Bearb.: name: Th		letzte Aenderung: last modification: IB-Revision 14.12.11 Th		Blatt-Global: page-global: 63/166		von from 12

Patent-, Gebrauchsmuster- oder Geschmacksmuster-Eintragung vorbehalten.
 of a patent, utility model or design.
 ausdrucklich gestattet. Zuwiderhandlungen verpflichten zu Schadenersatz. Alle Rechte fuer den Fall der authorisation is prohibited. Offenders will be held liable for the payment of damages. All rights reserved in the event of the grant
 Weitergabe sowie Vervielfaeltigung dieses Dokuments, Verwertung und Mitteilung seines Inhalts sind verboten, soweit nicht The reproduction, distribution and utilization of this document as well as the communication of its contents to others without express

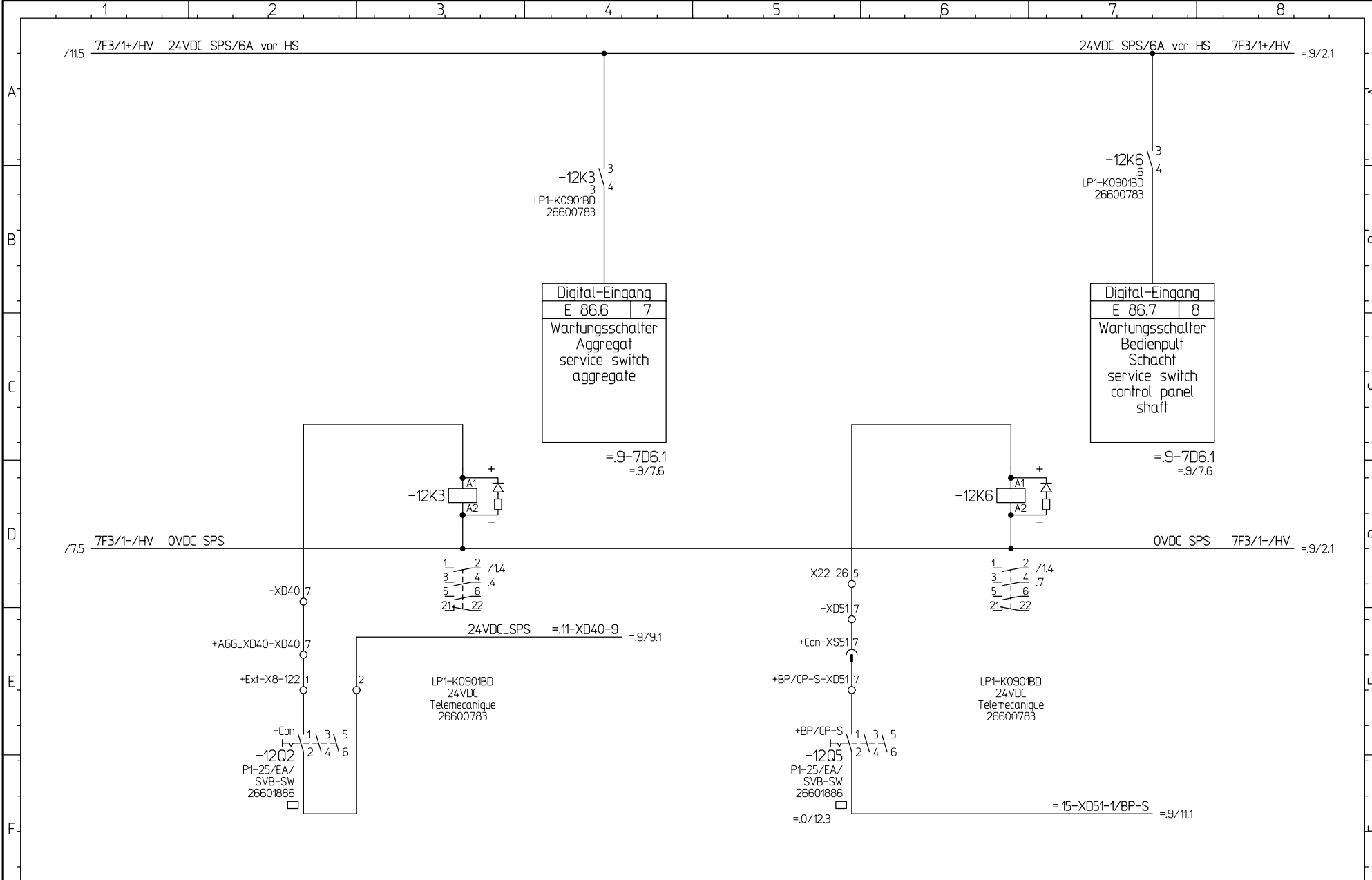



			CAD! KEINE MANUELLEN AENDERUNGEN! CAD! DONT CHANGE MANUAL		 Herrenknecht AG Schlehenweg 2 D-77963 Schwanau 2 Tel.: 07824 302-0 Fax.: 07824 3403 Info@Herrenknecht.de	Projekt: M-1642-C =Container		Wartungsschalter XD40 maintenance switch XD40 Steuerspannung / control voltage		Stueckliste: parts list: 25186184		Fg.-Gruppe: funct.-group: .8		Blatt-Nr.: page-nr.: 12	
Ausdruck-Datum: printout-date: 14.12.11						Zn.-Nr.: drawn-nr.: 3478-562-002-8		Hauptverteilung main distribution board +HV/MDB		Datum: date: 26.08.2011		Bearb.: name: Th		letzte Aenderung: last modification: IB-Revision 14.12.11 Th	

Patent-, Gebrauchsmuster- oder Geschmacksmuster-Eintragung vorbehalten. of a patent, utility model or design.

ausdrucklich gestattet. Zuwiderhandlungen verpflichten zu Schadenersatz. Alle Rechte fuer den Fall der autorisation is prohibited. Offenders will be held liable for the payment of damages. All rights reserved in the event of the grant

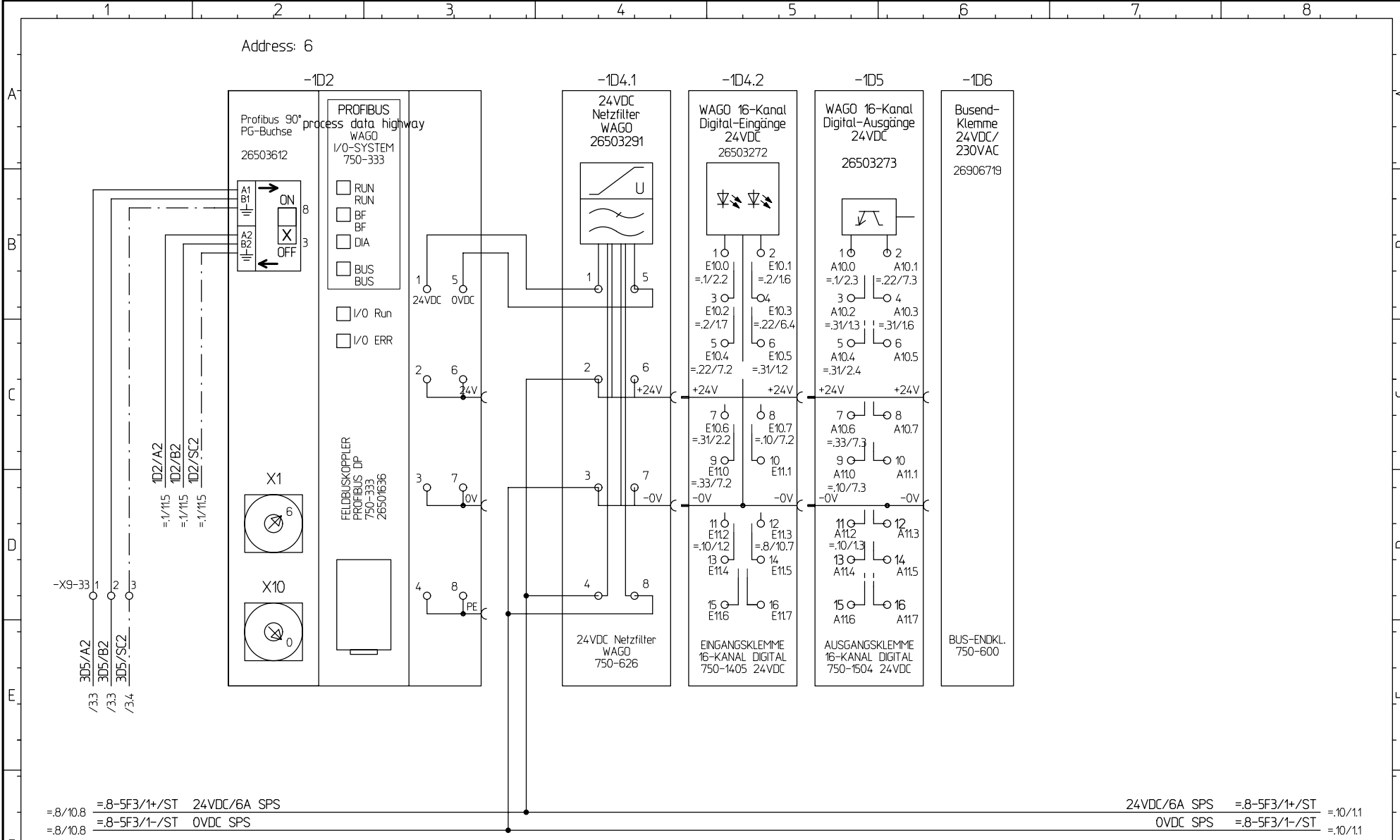
Weitergabe sowie Vervielfaeltigung dieses Dokuments, Verwertung und Mitteilung seines Inhalts sind verboten, soweit nicht The reproduction, distribution and utilization of this document as well as the communication of its contents to others without express



			CAD! KEINE MANUELLEN AENDERUNGEN! CAD! DONT CHANGE MANUAL		Herrenknecht AG Schlehenweg 2 D-77963 Schwanaau 2 Tel.: 07824 302-0 Fax.: 07824 3403 Info@Herrenknecht.de		Projekt: M-1642-C =Container		SPS-Anschaltung Steuerstand PLC interface connection Beckhoff SPS-Konfiguration / PLC-configuration		Stueckliste: parts list: 25186184		Fg.-Gruppe: funct.-group: .9		Blatt-Nr.: page-nr.: 1	
			Ausdruck-Datum: printout-date: 14.12.11				Zn.-Nr.: drawn-nr.: 3478-562-002-9		Steuerstand Control Cabin +ST/CC		Datum: date: 26.08.2011		Bearb.: name: Th		letzte Aenderung: last modification: IB-Revision 14.12.11 Th	
Index	Aenderung-Nr. Change No.:	Datum / Name date / name											Blatt-Global: page-global: 65/166		von from 12	

Patent-, Gebrauchsmuster- oder Geschmacksmuster-Eintragung vorbehalten.
 of a patent, utility model or design.
 ausdrucklich gestattet. Zuwiderhandlungen verpflichten zu Schadenersatz. Alle Rechte fuer den Fall der autorisation is prohibited. Offenders will be held liable for the payment of damages. All rights reserved in the event of the grant
 Weitergabe sowie Vervielfaeltigung dieses Dokuments, Verwertung und Mitteilung seines Inhalts sind verboten, soweit nicht The reproduction, distribution and utilization of this document as well as the communication of its contents to others without express

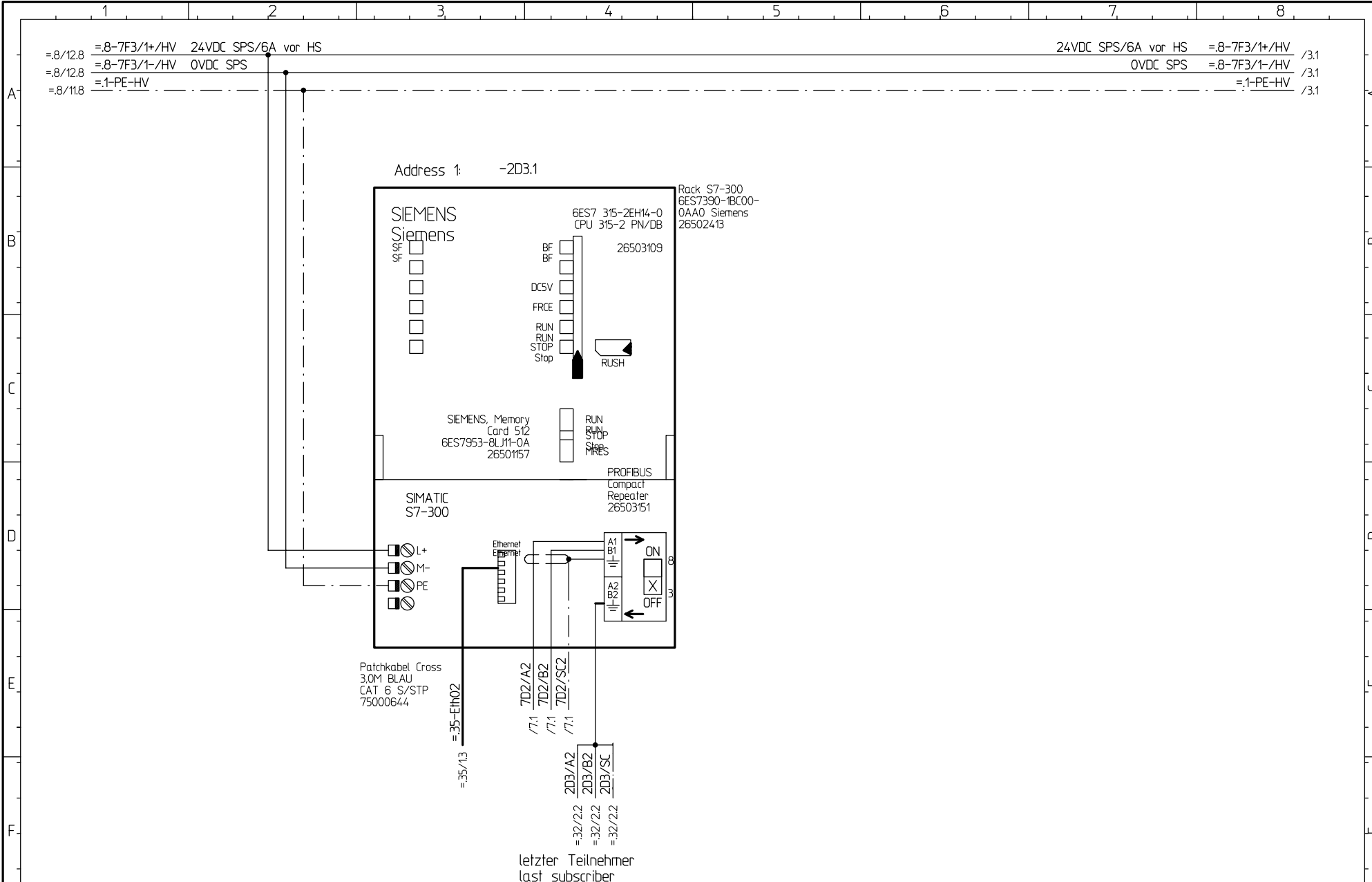



			CAD! KEINE MANUELLEN AENDERUNGEN! CAD! DONT CHANGE MANUAL		Herrenknecht AG Schlehenweg 2 D-77963 Schwanau 2 Tel.: 07824 302-0 Fax.: 07824 3403 Info@Herrenknecht.de		Projekt: project: M-1642-C =Container		SPS S7-300 CPU PLC S7-300 CPU SPS-Konfiguration / PLC-configuration		Stueckliste: parts list: 25186184		Fg.-Gruppe: funct.-group: .9		Blatt-Nr.: page-nr.: 2			
Ausdruck-Datum: printout-date: 14.12.11					Zn.-Nr.: drawn-nr.: 3478-562-002-.9		Hauptverteilung main distribution board +HV/MDB		Datum: date: 26.08.2011		Bearb.: name: Th		letzte Aenderung: last modification: IB-Revision 14.12.11 Th		Blatt-Global: page-global: 66/166		von from 12	

Patent-, Gebrauchsmuster- oder
Geschmacksmuster-Eintragung vorbehalten.
of a patent, utility model or design.

ausdrücklich gestattet. Zuwiderhandlungen verpflichten
zu Schadensersatz. Alle Rechte fuer den Fall der
Autorisation ist prohibited. Offenders will be held liable for the
payment of damages. All rights reserved in the event of the grant

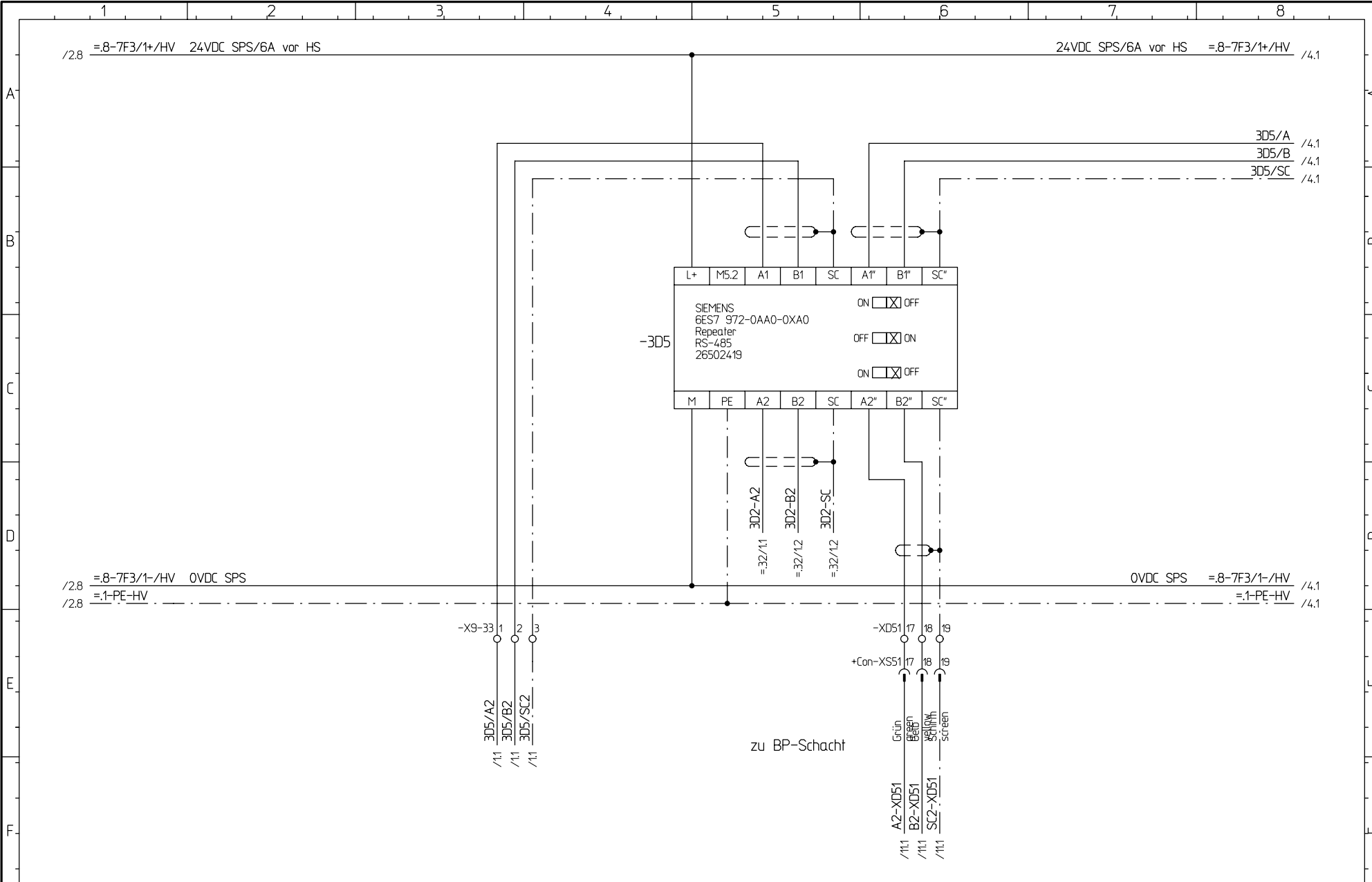
Weitergabe sowie Vervielfaeltigung dieses Dokuments, Verwertung
und Mitteilung seines Inhalts sind verboten, soweit nicht
The reproduction, distribution and utilization of this document as
well as the communication of its contents to others without express



			CAD! KEINE MANUELLEN AENDERUNGEN! CAD! DONT CHANGE MANUAL		 Herrenknecht AG Schlehenweg 2 D-77963 Schwanau 2 Tel.: 07824 302-0 Fax: 07824 3403 Info@Herrenknecht.de	Projekt: M-1642-C =Container		Profibus-Repeater profibus-Repeater SPS-Konfiguration / PLC-configuration		Stueckliste: parts list: 25186184		Fg.-Gruppe: funct.-group: .9		Blatt-Nr.: page-nr.: 3				
Ausdruck-Datum: printout-date: 14.12.11						Zn.-Nr.: drawn-nr.: 3478-562-002-.9		Hauptverteilung main distribution board +HV/MDB		Datum: date: 26.08.2011		Bearb.: name: Th		letzte Aenderung: last modification: IB-Revision 14.12.11 Th		Blatt-Global: page-global: 67/166		von from 12

Patent-, Gebrauchsmuster- oder
Geschmacksmuster-Eintragung vorbehalten.
of a patent, utility model or design.

ausdrücklich gestattet. Zuwiderhandlungen verpflichten
zu Schadensersatz. Alle Rechte fuer den Fall der
Auhorization is prohibited. Offenders will be held liable for the
payment of damages. All rights reserved in the event of the grant

Weitergabe sowie Vervielfaeltigung dieses Dokuments, Verwertung
und Mitteilung seines Inhalts sind verboten, soweit nicht
The reproduction, distribution and utilization of this document as
well as the communication of its contents to others without express

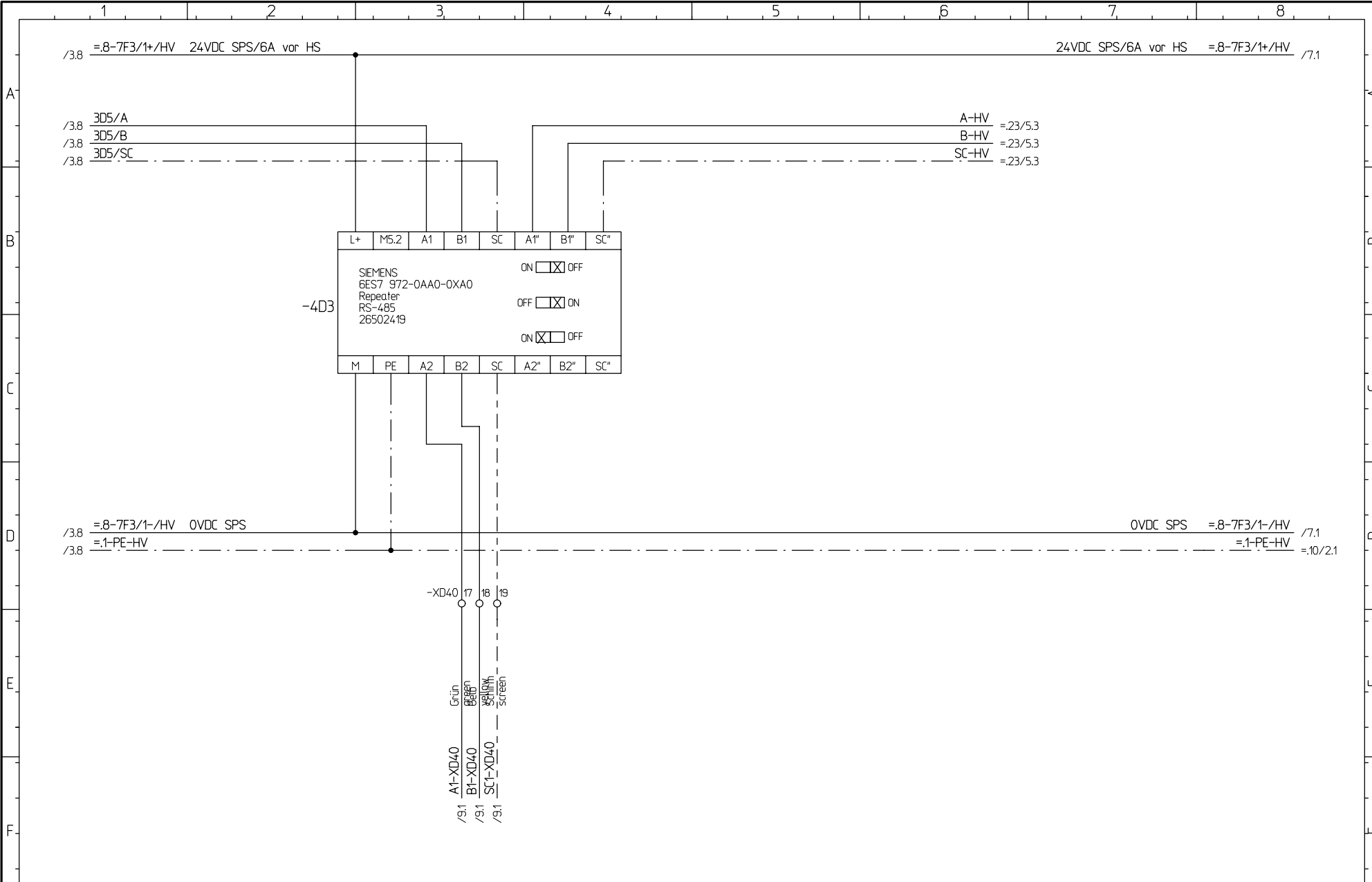

Index	Änderung-Nr. Change No.:	Datum / Name date / name
Index		

CAD! KEINE MANUELLEN
ÄNDERUNGEN!
CAD!
DONT CHANGE MANUAL

Ausdruck-Datum:
printout-date:
14.12.11



Herrenknecht AG
Schlehenweg 2
D-77963 Schwanau 2
Tel.: 07824 302-0
Fax.: 07824 3403
Info@Herrenknecht.de

Projekt:
project: M-1642-C
=Container

Zn.-Nr.:
drawn-nr.: 3478-562-002-.9

Profibus-Repeater
SPS-Konfiguration / PLC-Konfiguration

Hauptverteilung
main distribution board
+HV/MDB

Datum:
date: 26.08.2011

Bearb.:
name: Th

Stueckliste: parts list: 25186184	Fg.-Gruppe: funct.-group: .9	Blatt-Nr.: page-nr.: 4
letzte Aenderung: last modification: IB-Revision 14.12.11 Th	Blatt-Global: page-global: 68/166	von from 12

Patent-, Gebrauchsmuster- oder Geschmacksmuster-Eintragung vorbehalten.
 of a patent, utility model or design.

ausdrücklich gestattet. Zuwiderhandlungen verpflichten zu Schadensersatz. Alle Rechte fuer den Fall der Auhorisation ist prohibited. Offenders will be held liable for the payment of damages. All rights reserved in the event of the grant

Weitergabe sowie Vervielfaeltigung dieses Dokuments, Verwertung und Mitteilung seines Inhalts sind verboten, soweit nicht The reproduction, distribution and utilization of this document as well as the communication of its contents to others without express

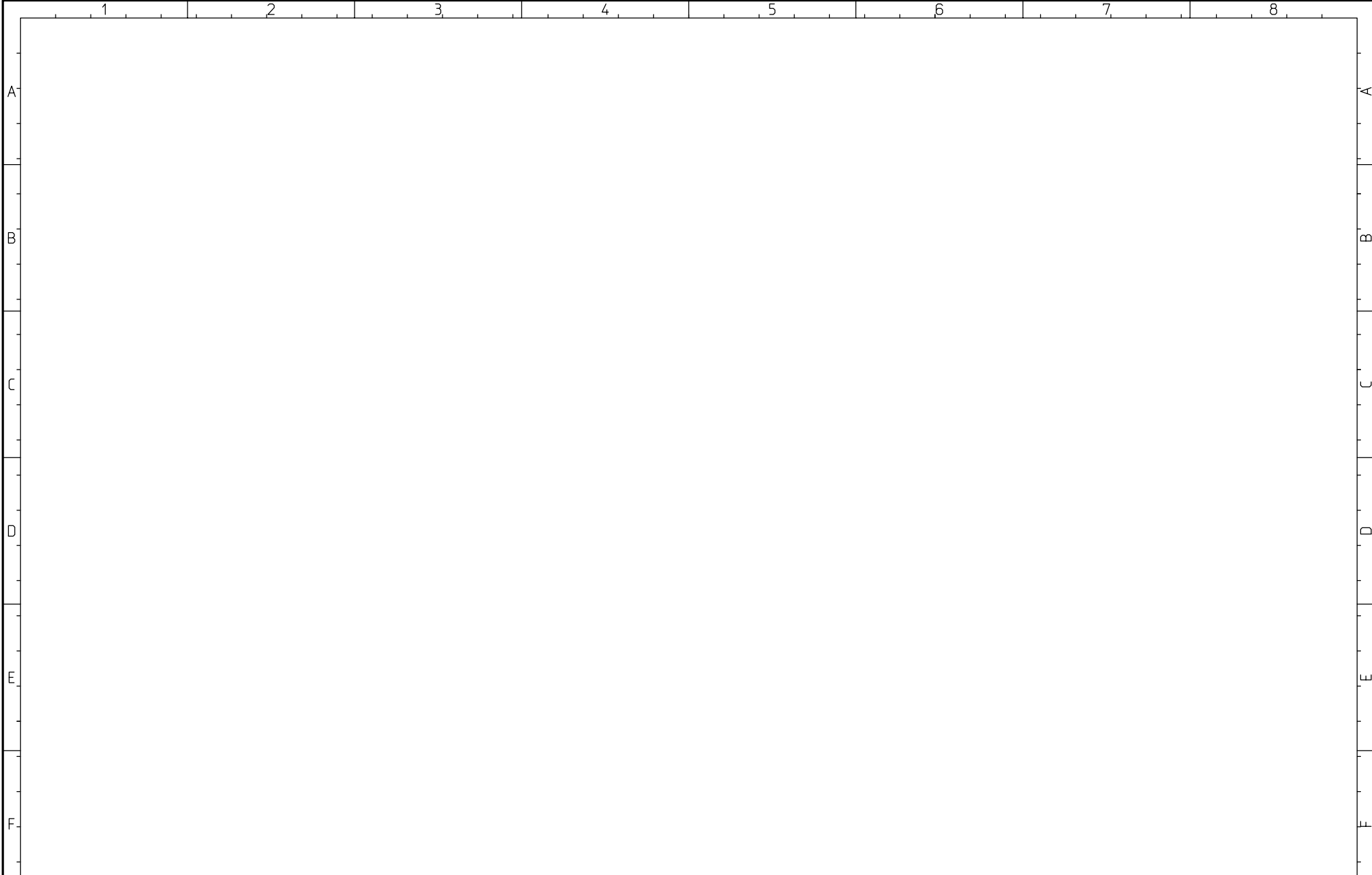



			CAD! KEINE MANUELLEN AENDERUNGEN ! CAD! DONT CHANGE MANUAL	 Herrenknecht AG Schlehenweg 2 D-77963 Schwanau 2 Tel.: 07824 302-0 Fax.: 07824 3403 Info@Herrenknecht.de	Projekt: project: M-1642-C	Reserve reserve	Stueckliste: parts list: 25186184	Fg.-Gruppe: funct.-group: .9	Blatt-Nr.: page-nr.: 5	
Index Index	Aenderung-Nr. Change No.:	Datum / Name date / name	Ausdruck-Datum: printout-date: 14.12.11		=Container	Zn.-Nr.: drawn-nr.: 3478-562-002-.9	Datum: date: 26.08.2011	Bearb.: name: Th	letzte Aenderung: last modification: 14.12.11 Th	Blatt-Global: page-global: 69/166

Patent-, Gebrauchsmuster-, oder Geschmacksmuster-Eintragung vorbehalten.
 of a patent, utility model or design.

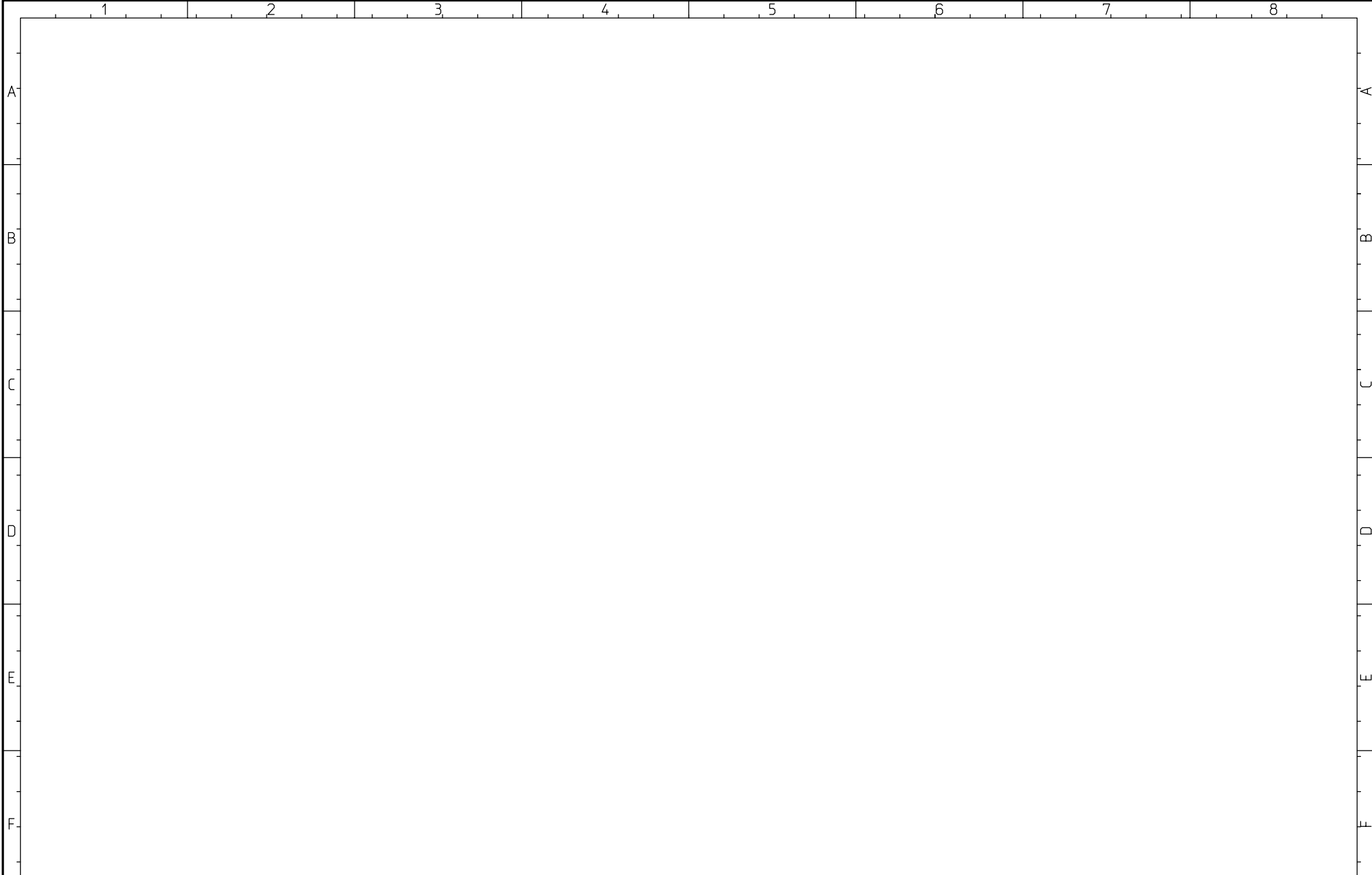

ausdrücklich gestattet. Zuwiderhandlungen verpflichten zu Schadensersatz. Alle Rechte fuer den Fall der Auhorisation ist prohibited. Offenders will be held liable for the payment of damages. All rights reserved in the event of the grant

Weitergabe sowie Vervielfaeltigung dieses Dokuments, Verwertung und Mitteilung seines Inhalts sind verboten, soweit nicht The reproduction, distribution and utilization of this document as well as the communication of its contents to others without express

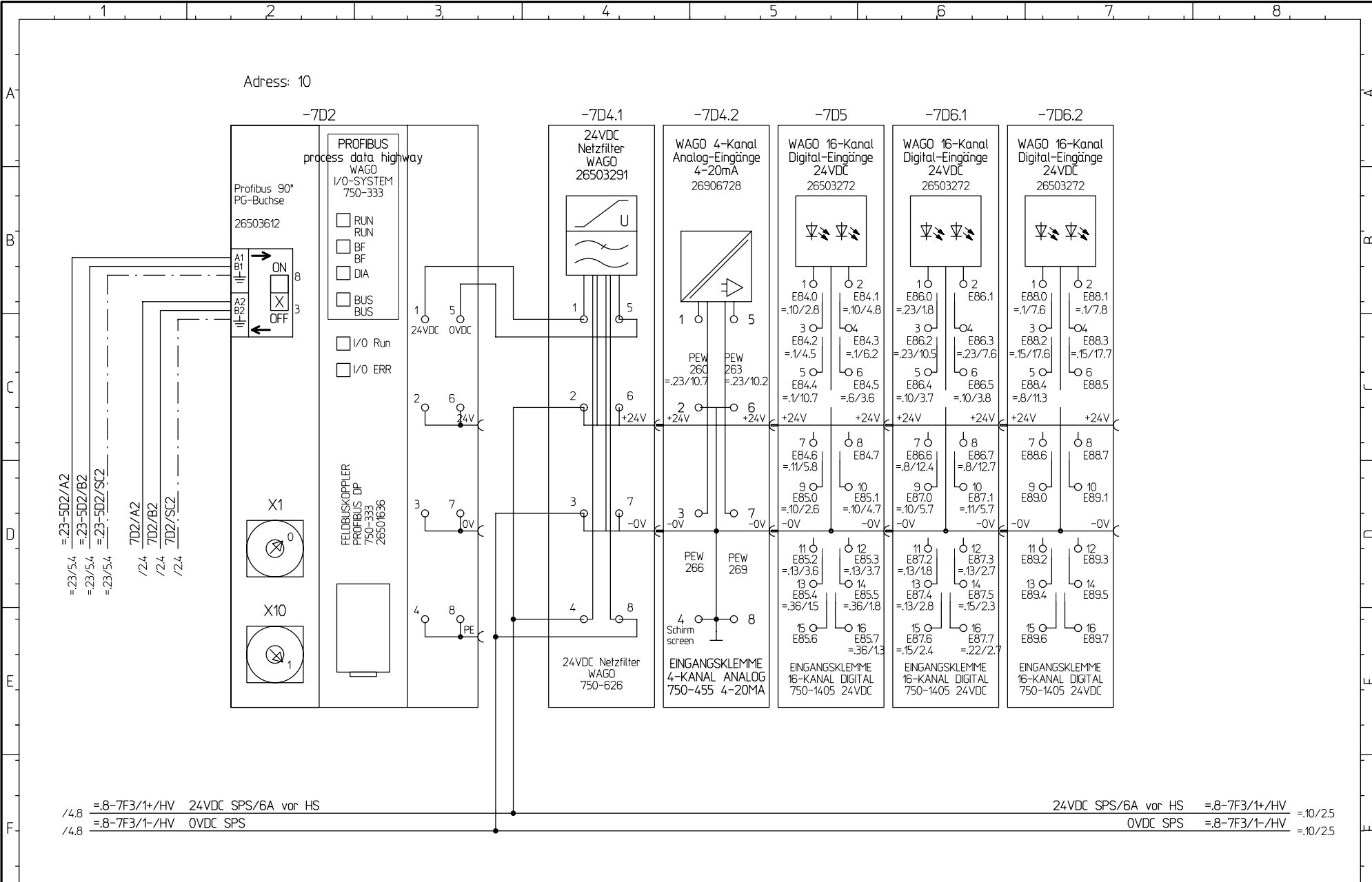

			CAD! KEINE MANUELLEN AENDERUNGEN ! CAD! DONT CHANGE MANUAL	 Herrenknecht AG Schlehenweg 2 D-77963 Schwanau 2 Tel.: 07824 302-0 Fax.: 07824 3403 Info@Herrenknecht.de	Projekt: project: M-1642-C	Reserve reserve	Stueckliste: parts list: 25186184	Fg.-Gruppe: funct.-group: .9	Blatt-Nr.: page-nr.: 6	
Index Index	Aenderung-Nr. Change No.:	Datum / Name date / name	Ausdruck-Datum: printout-date: 14.12.11		=Container	Zn.-Nr.: drawn-nr.: 3478-562-002-.9	Datum: date: 26.08.2011	Bearb.: name: Th	letzte Aenderung: last modification: 14.12.11 Th	Blatt-Global: page-global: 70/166





Index		Änderung-Nr. Change No.:		Datum / Name date / name		CAD! KEINE MANUELLEN ÄNDERUNGEN! DONT CHANGE MANUAL		 Herrenknecht AG Schlehenweg 2 D-77963 Schwanau 2 Tel.: 07824 302-0 Fax.: 07824 3403 Info@Herrenknecht.de		Projekt: project: M-1642-C =Container		SPS-Anschaltung Hauptverteilung PLC interface connection main distribution SPS-Konfiguration / PLC-configuration		Stueckliste: parts list: 25186184		Fg.-Gruppe: funct.-group: .9		Blatt-Nr.: page-nr.: 7					
Index		Änderung-Nr. Change No.:		Datum / Name date / name		Ausdruck-Datum: printout-date: 14.12.11		 Herrenknecht AG Schlehenweg 2 D-77963 Schwanau 2 Tel.: 07824 302-0 Fax.: 07824 3403 Info@Herrenknecht.de		Zn.-Nr.: drawn-nr.: 3478-562-002-9		Hauptverteilung main distribution board +HV/MBB		Datum: date: 26.08.2011		Bearb.: name: Th		letzte Aenderung: last modification: IB-Revision 14.12.11 Th		Blatt-Global: page-global: 71/166		von from 12	

Patent-, Gebrauchsmuster- oder
 Geschmacksmuster-Eintragung vorbehalten.
 of a patent, utility model or design.

ausdrücklich gestattet. Zuwiderhandlungen verpflichten
 zu Schadensersatz. Alle Rechte fuer den Fall der
 authorisation is prohibited. Offenders will be held liable for the
 payment of damages. All rights reserved in the event of the grant

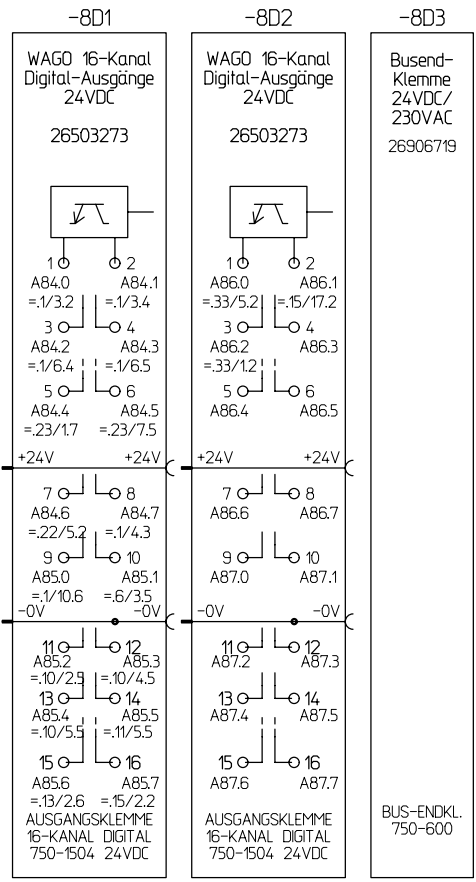
Weitergabe sowie Vervielfaeltigung dieses Dokuments, Verwertung
 und Mitteilung seines Inhalts sind verboten, soweit nicht
 The reproduction, distribution and utilization of this document as
 well as the communication of its contents to others without express



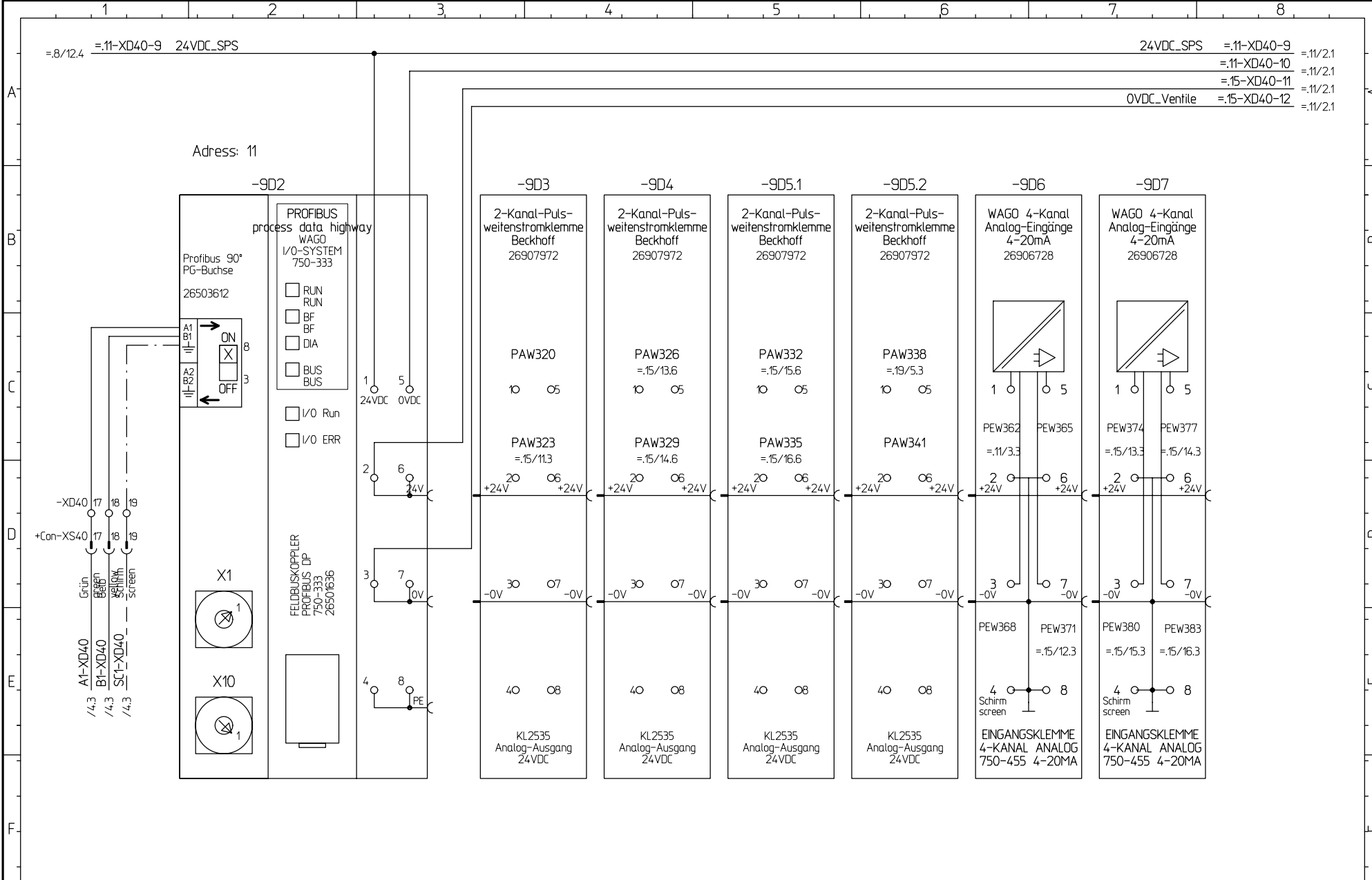

			CAD! KEINE MANUELLEN AENDERUNGEN! CAD! DONT CHANGE MANUAL		 Herrenknecht AG Schlehenweg 2 D-77963 Schwanau 2 Tel.: 07824 302-0 Fax.: 07824 3403 Info@Herrenknecht.de		Projekt: project: M-1642-C		SPS PLC		Stueckliste: parts list: 25186184		Fg.-Gruppe: funct.-group: .9		Blatt-Nr.: page-nr.: 8	
			Ausdruck-Datum: printout-date: 14.12.11				=Container		SPS-Konfiguration / PLC-configuration				Blatt-Global: page-global: 72/166		von from 12	
Index	Aenderung-Nr. Change No.:	Datum / Name date / name				Zn.-Nr. / drawn-nr.: 3478-562-002-.9	Hauptverteilung main distribution board +HV/MDB		Datum: date: 26.08.2011	Bearb. name: Th	letzte Aenderung: last modification: IB-Revision 14.12.11 Th					

Patent-, Gebrauchsmuster- oder Geschmacksmuster-Eintragung vorbehalten.
 Patent-, Gebrauchsmuster- oder Geschmacksmuster-Eintragung vorbehalten.
 ausdrucklich gestattet. Zuwiderhandlungen verpflichten zu Schadenersatz. Alle Rechte fuer den Fall der autorisation is prohibited. Offenders will be held liable for the payment of damages. All rights reserved in the event of the grant
 Weitergabe sowie Vervielfaeltigung dieses Dokuments, Verwertung und Mitteilung seines Inhalts sind verboten, soweit nicht
 The reproduction, distribution and utilization of this document as well as the communication of its contents to others without express

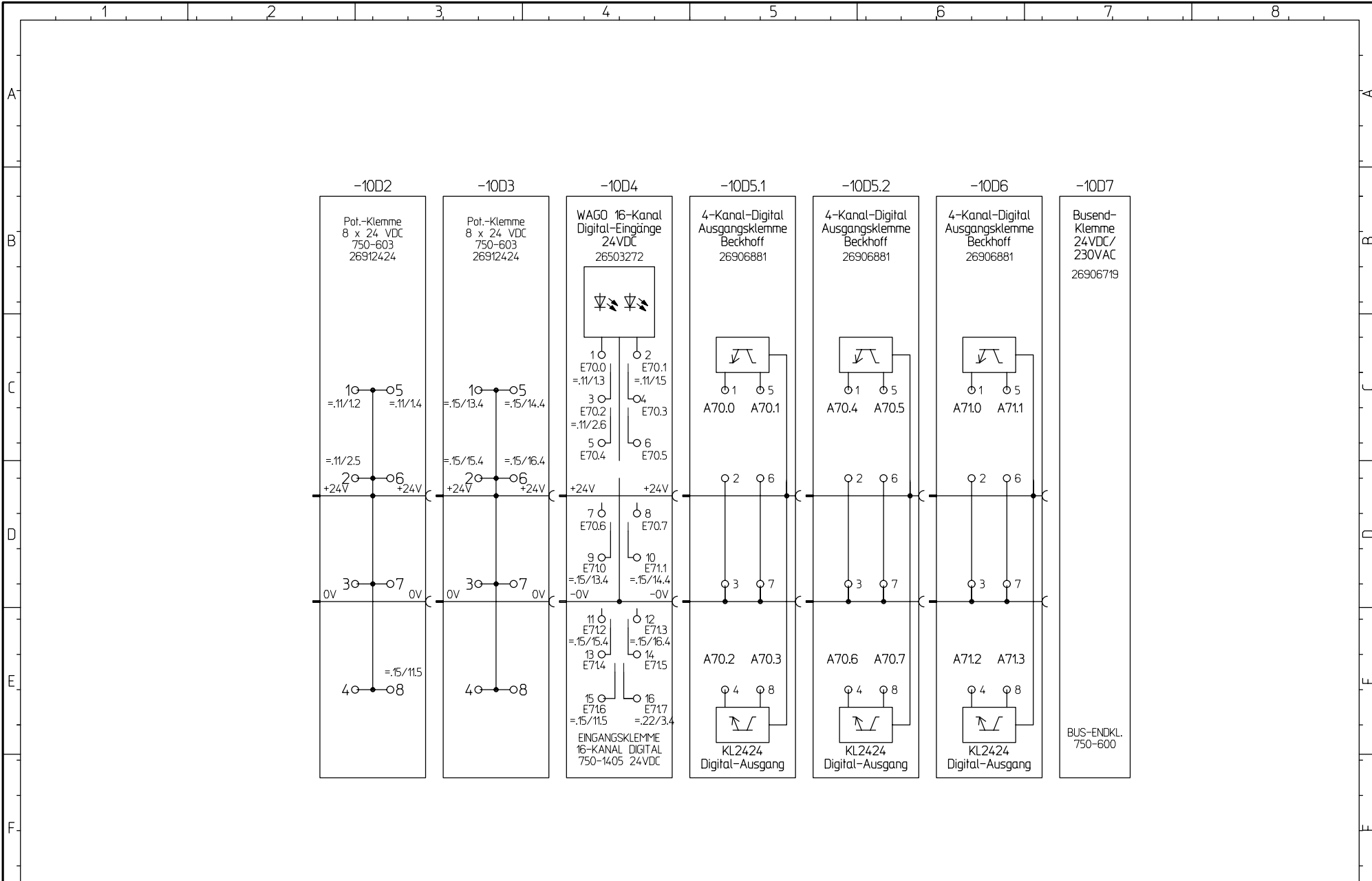

Index		Änderung-Nr. / Change No.:		Datum / Name / date / name		CAD! KEINE MANUELLEN AENDERUNGEN! DON'T CHANGE MANUAL		 Herrenknecht AG Schlehenweg 2 D-77963 Schwanau 2 Tel.: 07824 302-0 Fax: 07824 3403 Info@Herrenknecht.de		Projekt: M-1642-C		SPS-Anschaltung XD Aggregat PLC-interface connection XD aggregate		Stueckliste: parts list: 25186184		Fg.-Gruppe: funct.-group: .9		Blatt-Nr.: page-nr.: 9							
Index		Änderung-Nr. / Change No.:		Datum / Name / date / name		Ausdruck-Datum: printout-date: 14.12.11				=Container		Zn.-Nr.: drawn-nr.: 3478-562-002-9		SPS-Konfiguration / PLC-configuration		Aggregatedose XD40		Datum: date: 26.08.2011		Bearb.: name: Th		letzte Aenderung: last modification: IB-Revision 14.12.11 Th		Blatt-Global: page-global: 73/166	



			CAD! KEINE MANUELLEN AENDERUNGEN! CAD! DONT CHANGE MANUAL		 Herrenknecht AG Schlehenweg 2 D-77963 Schwanaau 2 Tel.: 07824 302-0 Fax.: 07824 3403 Info@Herrenknecht.de		Projekt: project: M-1642-C		SPS XD Aggregat PLC XD aggregate		Stueckliste: parts list: 25186184		Fg.-Gruppe: funct.-group: .9		Blatt-Nr.: page-nr.: 10	
			Ausdruck-Datum: printout-date: 14.12.11				=Container		SPS-Konfiguration / PLC-configuration				Blatt-Global: page-global: 74/166		von from 12	
Index	Aenderung-Nr. Change No.:	Datum / Name date / name				Zn.-Nr. drawn-nr.:	Aggregatedose XD40 +AGG_XD40		Datum: date:	Bearb. name:	letzte Aenderung: last modification: IB-Revision 14.12.11 Th					

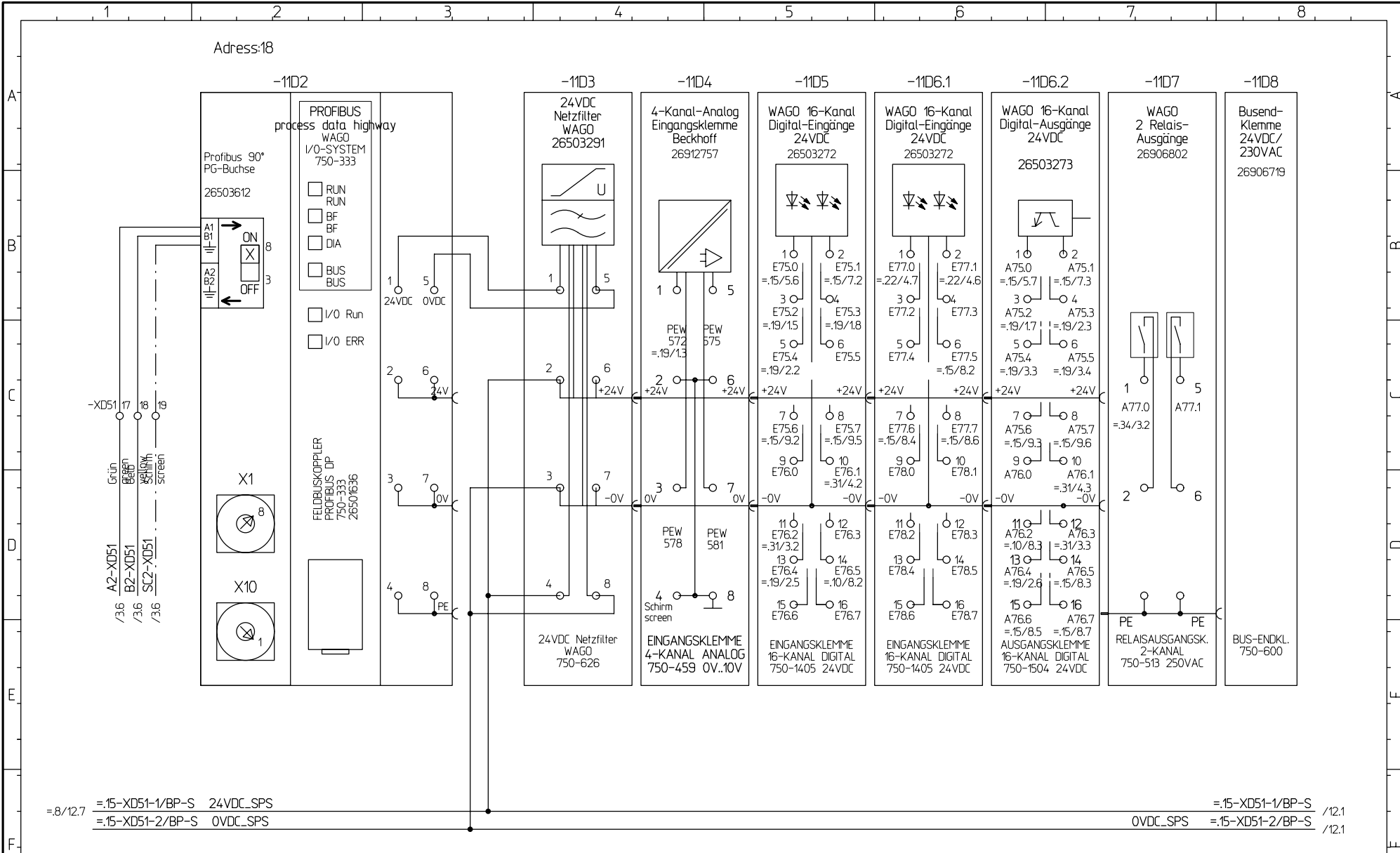

=.8/12.7
 =.15-XD51-1/BP-S 24VDC_SPS
 =.15-XD51-2/BP-S 0VDC_SPS

=.15-XD51-1/BP-S /12.1
 0VDC_SPS
 =.15-XD51-2/BP-S /12.1

			CAD! KEINE MANUELLEN AENDERUNGEN! CAD! DONT CHANGE MANUAL		 Herrenknecht AG Schlehenweg 2 D-77963 Schwanau 2 Tel.: 07824 302-0 Fax.: 07824 3403 Info@Herrenknecht.de	Projekt: M-1642-C =Container		SPS-Anschaltung BP-Schacht PLC-interface connection control panel shaft SPS-Konfiguration / PLC-configuration		Stueckliste: parts list: 25186184		Fg.-Gruppe: funct.-group: .9		Blatt-Nr.: page-nr.: 11				
Ausdruck-Datum: printout-date: 14.12.11						Zn.-Nr.: drawn-nr.: 3478-562-002-9		Bedienpult Schacht control panel shaft +BP/CP-S		Datum: date: 26.08.2011		Bearb. name: Th		letzte Aenderung: last modification: IB-Revision 14.12.11 Th		Blatt-Global: page-global: 75/166		von from 12

Patent-, Gebrauchsmuster- oder
Geschmacksmuster-Eintragung vorbehalten.
of a patent, utility model or design.

ausdruecklich gestattet. Zuwiderhandlungen verpflichten
zu Schadensersatz. Alle Rechte fuer den Fall der
Auhorisation is prohibited. Offenders will be held liable for the
payment of damages. All rights reserved in the event of the grant

Weitergabe sowie Vervielfaeltigung dieses Dokuments, Verwertung
und Mitteilung seines Inhalts sind verboten, soweit nicht
The reproduction, distribution and utilization of this document as
well as the communication of its contents to others without express

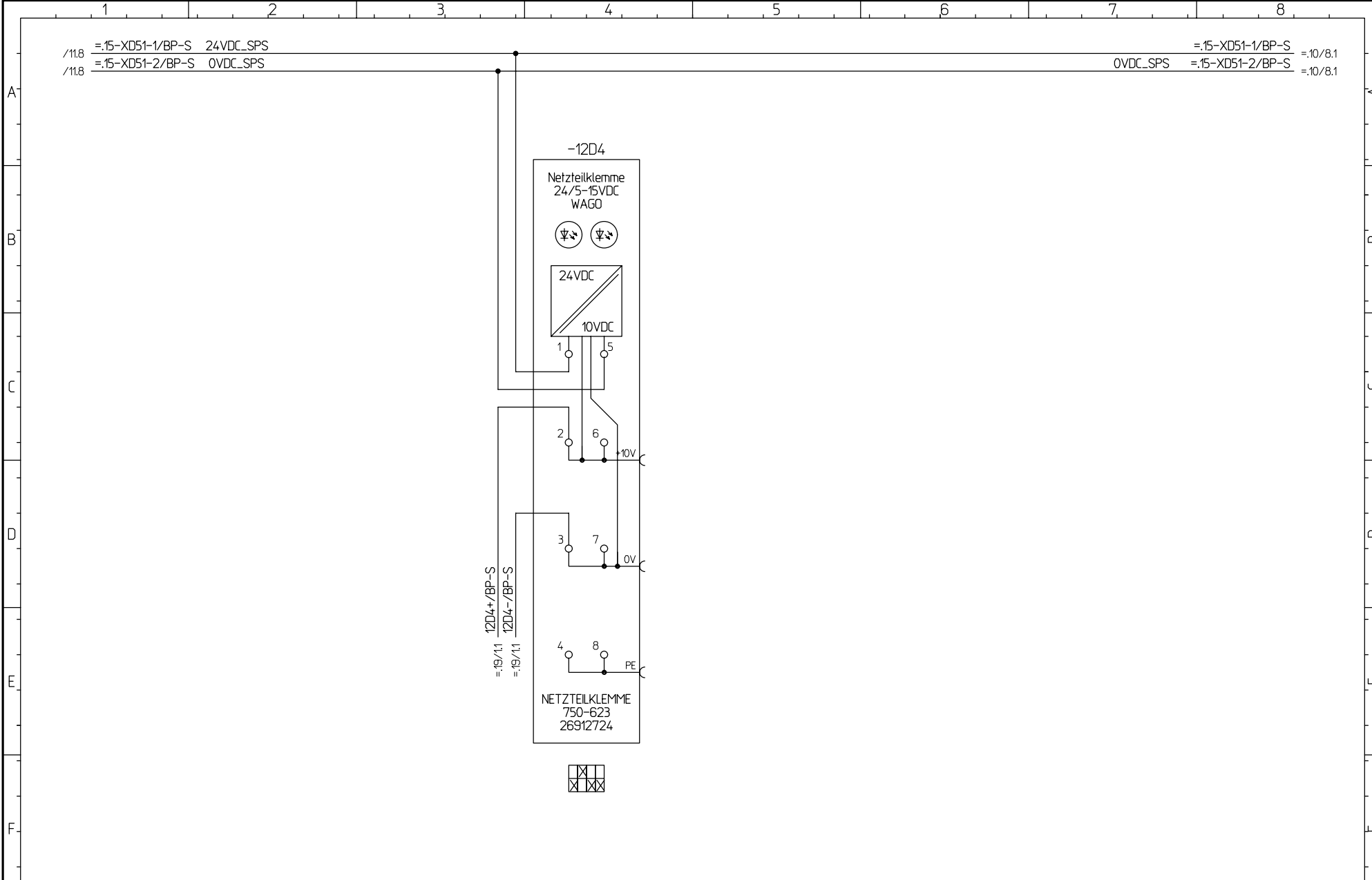

			CAD! KEINE MANUELLEN AENDERUNGEN! CAD! DONT CHANGE MANUAL		Herrenknecht AG Schlehenweg 2 D-77963 Schwanau 2 Tel.: 07824 302-0 Fax.: 07824 3403 Info@Herrenknecht.de		Projekt: project: M-1642-C		SPS BP-Schacht, Netzteilklemme 10VDC		Stueckliste: parts list: 25186184		Fg.-Gruppe: funct.-group: .9		Blatt-Nr.: page-nr.: 12	
			Ausdruck-Datum: printout-date: 14.12.11				=Container		SPS-Konfiguration / PLC-configuration				Blatt-Global: page-global: 76/166		von from 12	
Index	Aenderung-Nr. Change No.:	Datum / Name date / name				Zn.-Nr. drawn-nr.:	Bedienpult Schacht control panel shaft +BP/CP-S		Datum: date:	Bearb. name:	letzte Aenderung: last modification: 14.12.11 Th					
						3478-562-002-.9			26.08.2011	Th						

Patent-, Gebrauchsmuster- oder Geschmacksmuster-Eintragung vorbehalten.
 of a patent, utility model or design.
 ausdrücklich gestattet. Zuwiderhandlungen verpflichten zu Schadenersatz. Alle Rechte fuer den Fall der Autorisation ist prohibited. Offenders will be held liable for the payment of damages. All rights reserved in the event of the grant
 Weitergabe sowie Vervielfaeltigung dieses Dokuments, Verwertung und Mitteilung seines Inhalts sind verboten, soweit nicht The reproduction, distribution and utilization of this document as well as the communication of its contents to others without express

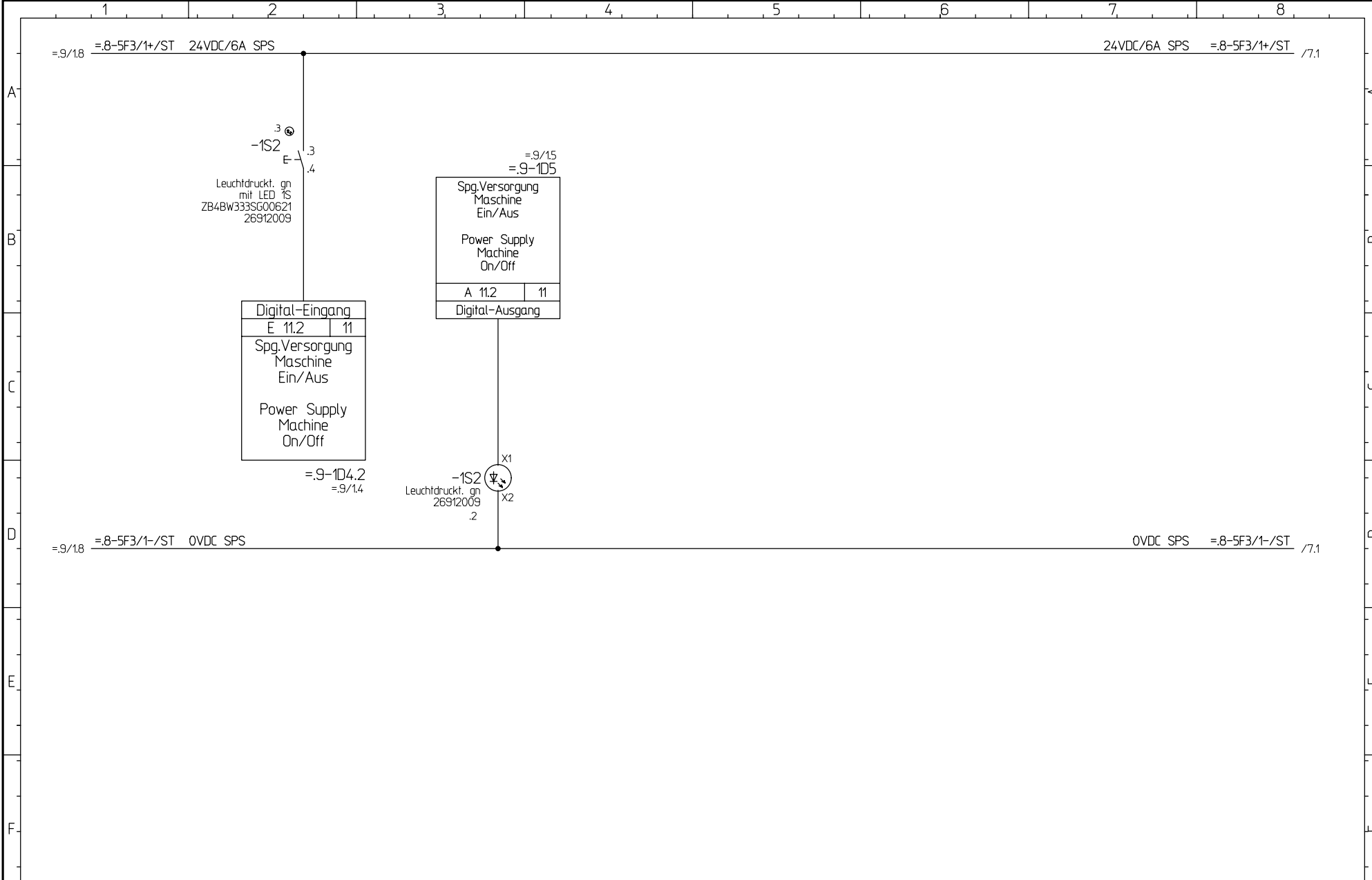

			CAD! KEINE MANUELLEN AENDERUNGEN! CAD! DONT CHANGE MANUAL		 Herrenknecht AG Schlehenweg 2 D-77963 Schwanau 2 Tel.: 07824 302-0 Fax.: 07824 3403 Info@Herrenknecht.de	Projekt: M-1642-C =Container		Spannungsvers. Maschine Ein/Aus Power Supply Machine On/Off Abgänge, Vorsicherung / outlets, prefuse		Stueckliste: parts list: 25186184		Fg.-Gruppe: funct.-group: .10		Blatt-Nr.: page-nr.: 1				
			Ausdruck-Datum: printout-date: 14.12.11			Zn.-Nr.: drawn-nr.: 3478-562-002-.10		Steuerstand Control Cabin +ST/CC		Datum: date: 26.08.2011		Bearb.: name: Th		letzte Aenderung: last modification: IB-Revision 14.12.11 Th		Blatt-Global: page-global: 77/166		von from 8

Patent-, Gebrauchsmuster- oder Geschmacksmuster-Eintragung vorbehalten.
 of a patent, utility model or design.

ausdrucklich gestattet. Zuwiderhandlungen verpflichten zu Schadensersatz. Alle Rechte fuer den Fall der authorisation is prohibited. Offenders will be held liable for the payment of damages. All rights reserved in the event of the grant

Weitergabe sowie Vervielfaeltigung dieses Dokuments, Verwertung und Mitteilung seines Inhalts sind verboten, soweit nicht The reproduction, distribution and utilization of this document as well as the communication of its contents to others without express

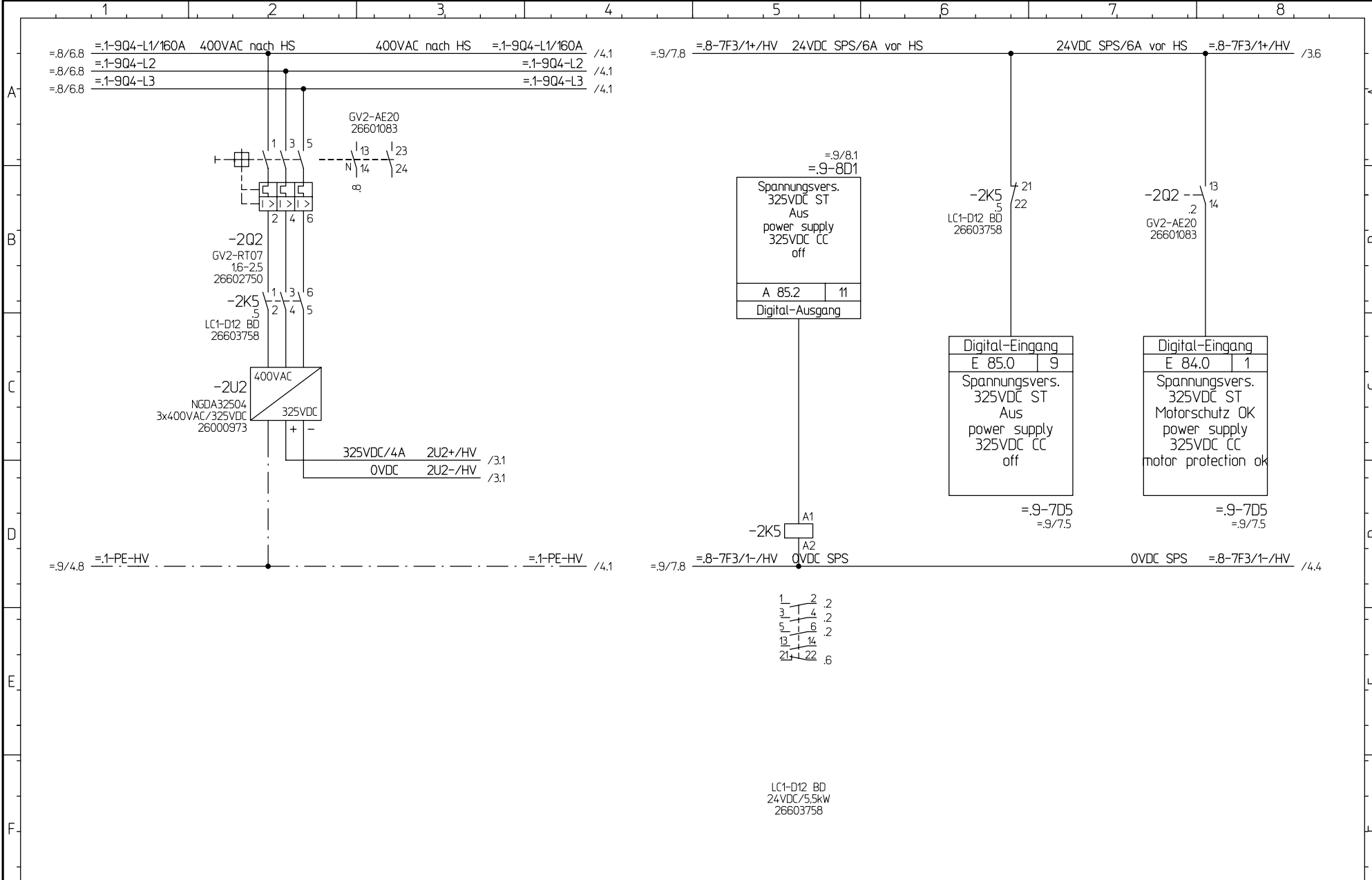



- 1 - 2 .2
- 3 - 4 .2
- 5 - 6 .2
- 13 - 14 .6
- 21 - 22 .6

LC1-D12 BD
24VDC/5,5kW
26603758

CAD! KEINE MANUELLEN AENDERUNGEN! CAD! DONT CHANGE MANUAL			 Herrenknecht AG Schlehenweg 2 D-77963 Schwanau 2 Tel.: 07824 302-0 Fax.: 07824 3403 Info@Herrenknecht.de	Projekt: M-1642-C =Container		Spannungsversorgung Steuerstand 325VDC power supply control cabin 325VDC Abgänge, Vorsicherung / outlets, prefuse		Stueckliste: parts list: 25186184		Fg.-Gruppe: funct.-group: .10		Blatt-Nr.: page-nr.: 2				
Ausdruck-Datum: printout-date: 14.12.11				Zn.-Nr.: drawn-nr.: 3478-562-002-10		Hauptverteilung main distribution board +HV/MBB		Datum: date: 26.08.2011		Bearb.: name: Th		letzte Aenderung: last modification: IB-Revision 14.12.11 Th		Blatt-Global: page-global: 78/166		von from 8

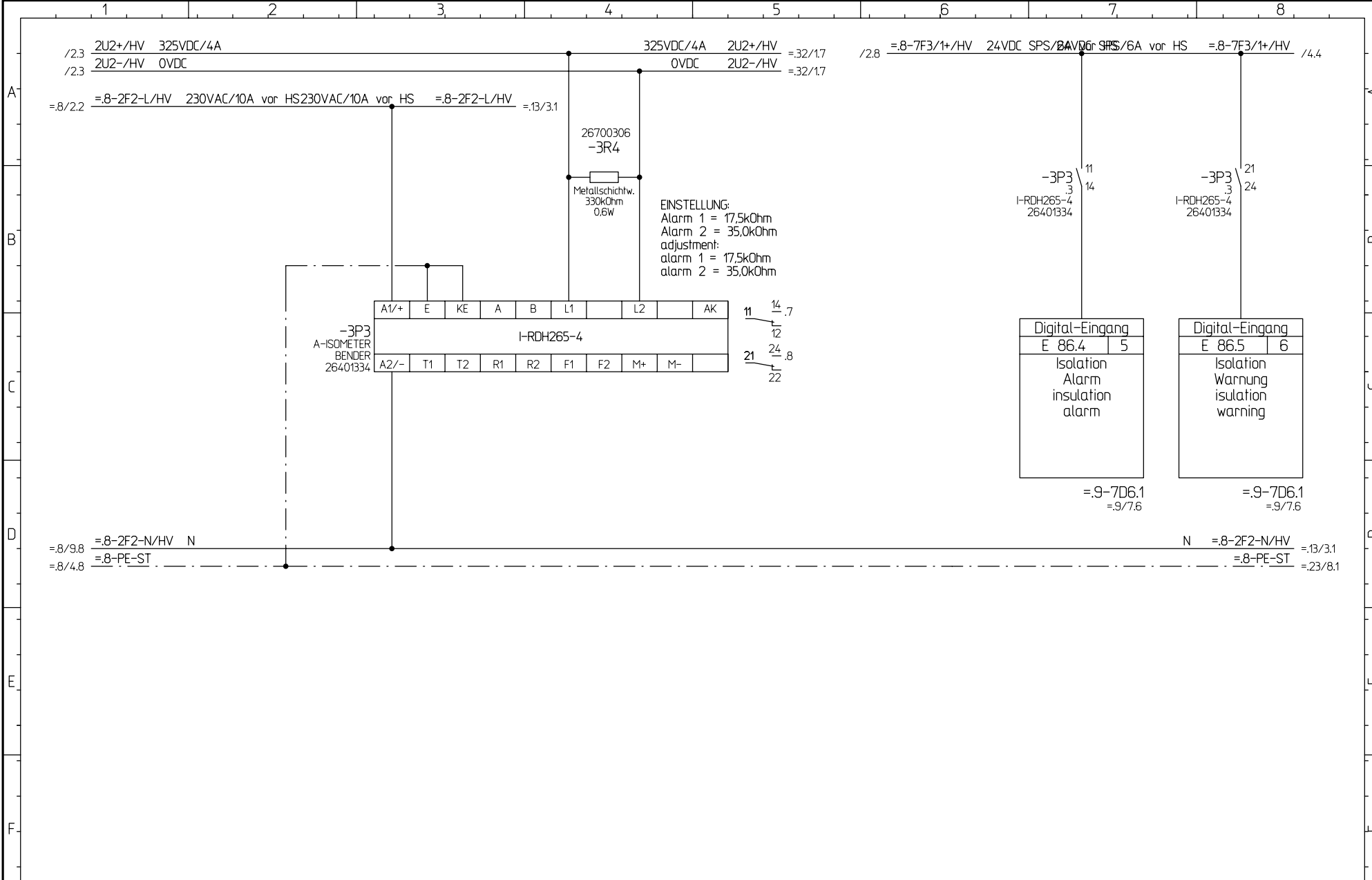
Patent-, Gebrauchsmuster- oder Geschmacksmuster-Eintragung vorbehalten.
 of a patent, utility model or design.
 ausdrucklich gestattet. Zuwiderhandlungen verpflichten zu Schadenersatz. Alle Rechte fuer den Fall der autorization is prohibited. Offenders will be held liable for the payment of damages. All rights reserved in the event of the grant
 Weitergabe sowie Vervielfaeltigung dieses Dokuments, Verwertung und Mitteilung seines Inhalts sind verboten, soweit nicht The reproduction, distribution and utilization of this document as well as the communication of its contents to others without express



			CAD! KEINE MANUELLEN AENDERUNGEN! CAD! DONT CHANGE MANUAL		 Herrenknecht AG Schlehenweg 2 D-77963 Schwanaau 2 Tel.: 07824 302-0 Fax.: 07824 3403 Info@Herrenknecht.de	Projekt: M-1642-C =Container		Isolationsueberwachung insulation control Abgaenge, Vorsicherung / outlets, prefuse		Stueckliste: parts list: 25186184		Fg.-Gruppe: funct.-group: .10		Blatt-Nr.: page-nr.: 3				
			Ausdruck-Datum: printout-date: 14.12.11			Zn.-Nr.: drawn-nr.: 3478-562-002-.10		Hauptverteilung main distribution board +HV/ MDB		Datum: date: 26.08.2011		Bearb. name: Th		letzte Aenderung: last modification: IB-Revision 14.12.11 Th		Blatt-Global: page-global: 79/166		von from 8

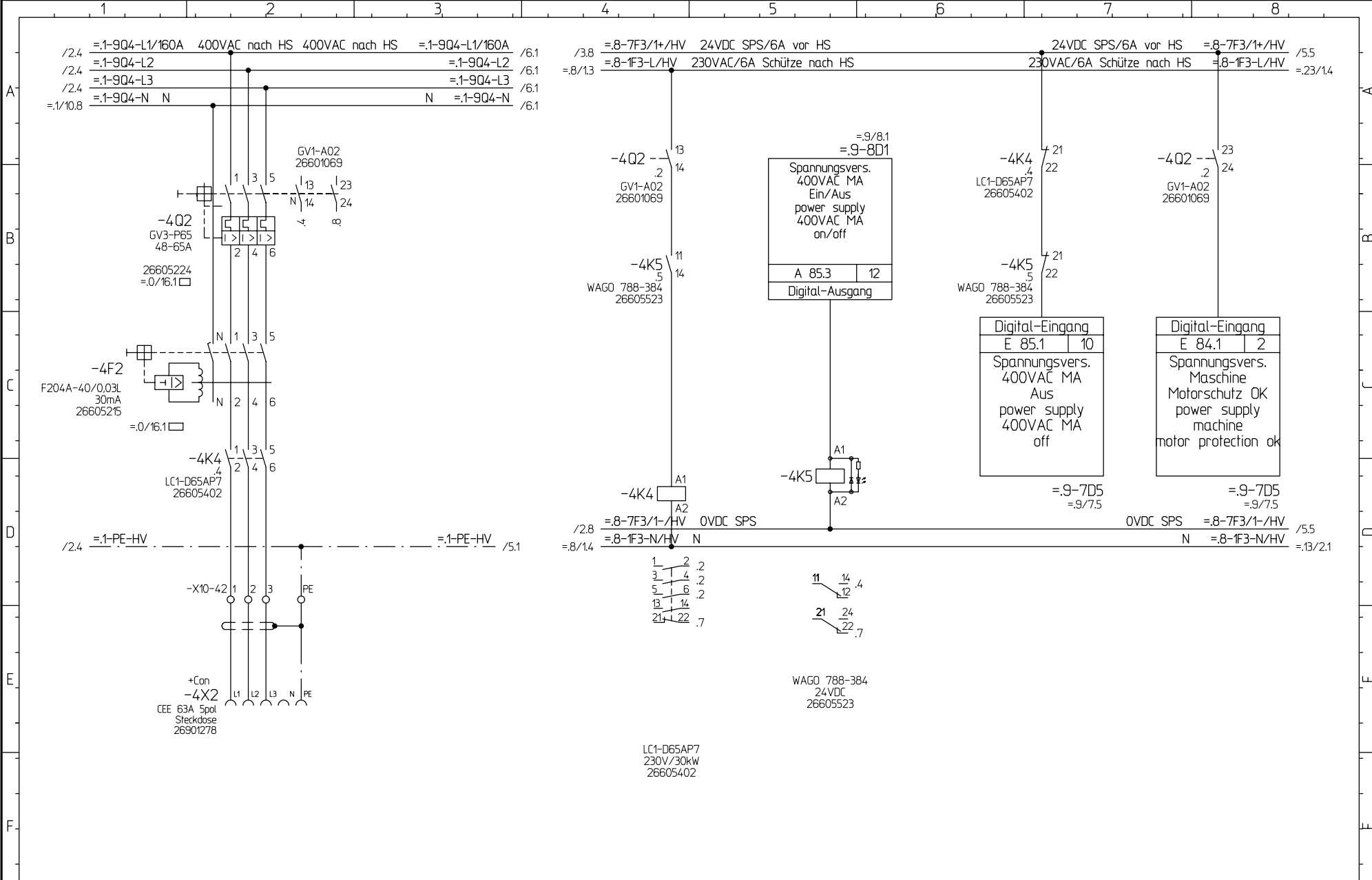

Patent-, Gebrauchsmuster- oder Geschmacksmuster-Eintragung vorbehalten.
 of a patent, utility model or design.
 ausdrucklich gestattet. Zuwiderhandlungen verpflichten zu Schadenersatz. Alle Rechte fuer den Fall der autorization is prohibited. Offenders will be held liable for the payment of damages. All rights reserved in the event of the grant
 Weitergabe sowie Vervielfaeltigung dieses Dokuments, Verwertung und Mitteilung seines Inhalts sind verboten, soweit nicht The reproduction, distribution and utilization of this document as well as the communication of its contents to others without express

CAD! KEINE MANUELLEN AENDERUNGEN! CAD! DONT CHANGE MANUAL Ausdruck-Datum: printout-date: 14.12.11			 Herrenknecht AG Schleheweg 2 D-77963 Schwanau 2 Tel.: 07824 302-0 Fax.: 07824 3403 Info@Herrenknecht.de	Projekt: M-1642-C =Container		Spannungsversorgung Maschine 400VAC power supply machine 400VAC Abgänge, Vorsicherung / outlets, prefuse		Stueckliste: parts list: 25186184		Fg.-Gruppe: funct.-group: .10		Blatt-Nr.: page-nr.: 4					
Index	Aenderung-Nr. Change No.:	Datum / Name date / name		Zn.-Nr.: drawn-nr.:	3478-562-002-10			Hauptverteilung main distribution board +HV/MB		Datum: date:	26.08.2011	Bearb. name:	Th	letzte Aenderung: last modification:	IB-Revision 14.12.11 Th	Blatt-Global: page-global: 80/166	von from

Patent-, Gebrauchsmuster- oder Geschmacksmuster-Eintragung vorbehalten.
 of a patent, utility model or design.
 ausdrucklich gestattet. Zuwiderhandlungen verpflichten zu Schadenersatz. Alle Rechte fuer den Fall der authorization is prohibited. Offenders will be held liable for the payment of damages. All rights reserved in the event of the grant
 Weitergabe sowie Vervielfaeltigung dieses Dokuments, Verwertung und Mitteilung seines Inhalts sind verboten, soweit nicht The reproduction, distribution and utilization of this document as well as the communication of its contents to others without express

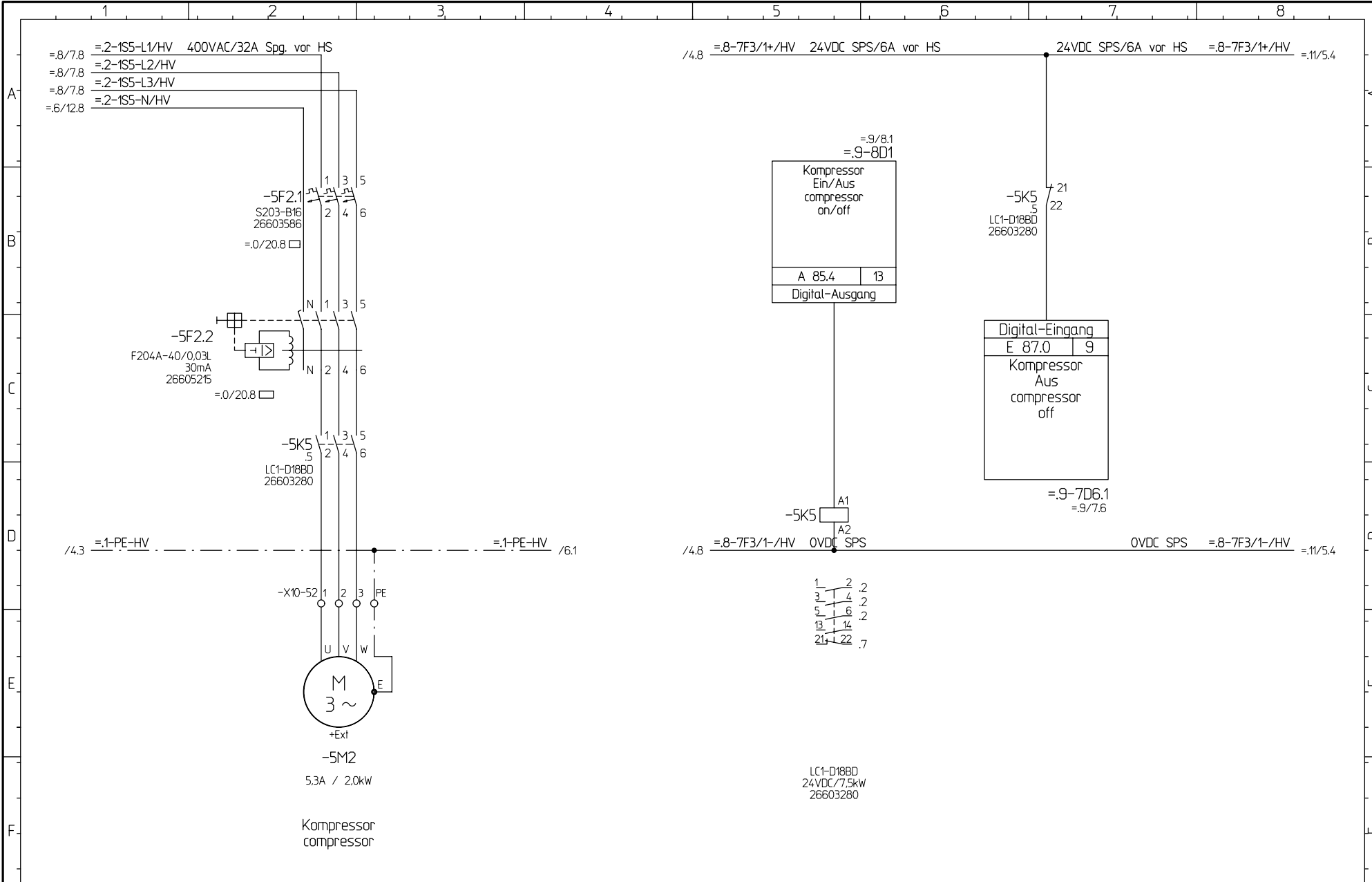

			CAD! KEINE MANUELLEN AENDERUNGEN! CAD! DONT CHANGE MANUAL Ausdruck-Datum: 14.12.11 printout-date:		 Herrenknecht AG Schlehenweg 2 D-77963 Schwanaau 2 Tel.: 07824 302-0 Fax.: 07824 3403 Info@Herrenknecht.de	Projekt: M-1642-C =Container		Kompressor compressor Abgänge, Vorsicherung / outlets, prefuse		Stueckliste: 25186184 parts list:		Fg.-Gruppe: .10 funct.-group:		Blatt-Nr.: 5 page-nr.:	
Index	Änderung-Nr. / Change No.:	Datum / Name / date / name				Zn.-Nr. / drawn-nr.:	Hauptverteilung main distribution board +HV/MDB		Datum: 26.08.2011	Bearb.: Th	letzte Aenderung: 14.12.11 Th last modification:		Blatt-Global: 81/166 page-global:		von / from

/4.3	=.1-9Q4-L1/160A	400VAC nach HS	400VAC nach HS	=.1-9Q4-L1/160A	=.11/5.1
/4.3	=.1-9Q4-L2			=.1-9Q4-L2	=.11/5.1
/4.3	=.1-9Q4-L3			=.1-9Q4-L3	=.11/5.1
/4.3	=.1-9Q4-N	N	N	=.1-9Q4-N	=.11/5.1

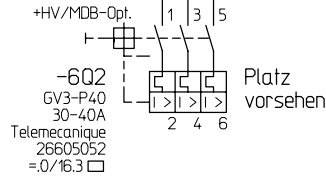

/5.4	=.1-PE-HV	=.1-PE-HV	=.11/5.1
------	-----------	-----------	----------

>>Option<<

			CAD! KEINE MANUELLEN ÄNDERUNGEN! CAD! DONT CHANGE MANUAL	 Herrenknecht AG Schlehenweg 2 D-77963 Schwanau 2 Tel.: 07824 302-0 Fax.: 07824 3403 Info@Herrenknecht.de	Projekt: project: M-1642-C	Abgang Reserve 32A Option outlet reserve 32A option	Stueckliste: parts list: 25186184	Fg.-Gruppe: funct.-group: .10	Blatt-Nr.: page-nr.: 6		
Index Index	Änderung-Nr. Change No.:	Datum / Name date / name	Ausdruck-Datum: printout-date: 14.12.11		=Container	Abgänge, Vorsicherung / outlets, prefuse	Hauptverteilung main distribution board +HV/MDB	Datum: date: 26.08.2011	Bearb.: name: Th	letzte Änderung: last modification: IB-Revision 14.12.11 Th	Blatt-Global: page-global: 82/166

Patent-, Gebrauchsmuster- oder Geschmacksmuster-Eintragung vorbehalten. of a patent, utility model or design.
 ausdrücklich gestattet. Zuwiderhandlungen verpflichten zu Schadensersatz. Alle Rechte fuer den Fall der authorisation is prohibited. Offenders will be held liable for the payment of damages. All rights reserved in the event of the grant
 Weitergabe sowie Vervielfaeltigung dieses Dokuments, Verwertung und Mitteilung seines Inhalts sind verboten, soweit nicht The reproduction, distribution and utilization of this document as well as the communication of its contents to others without express

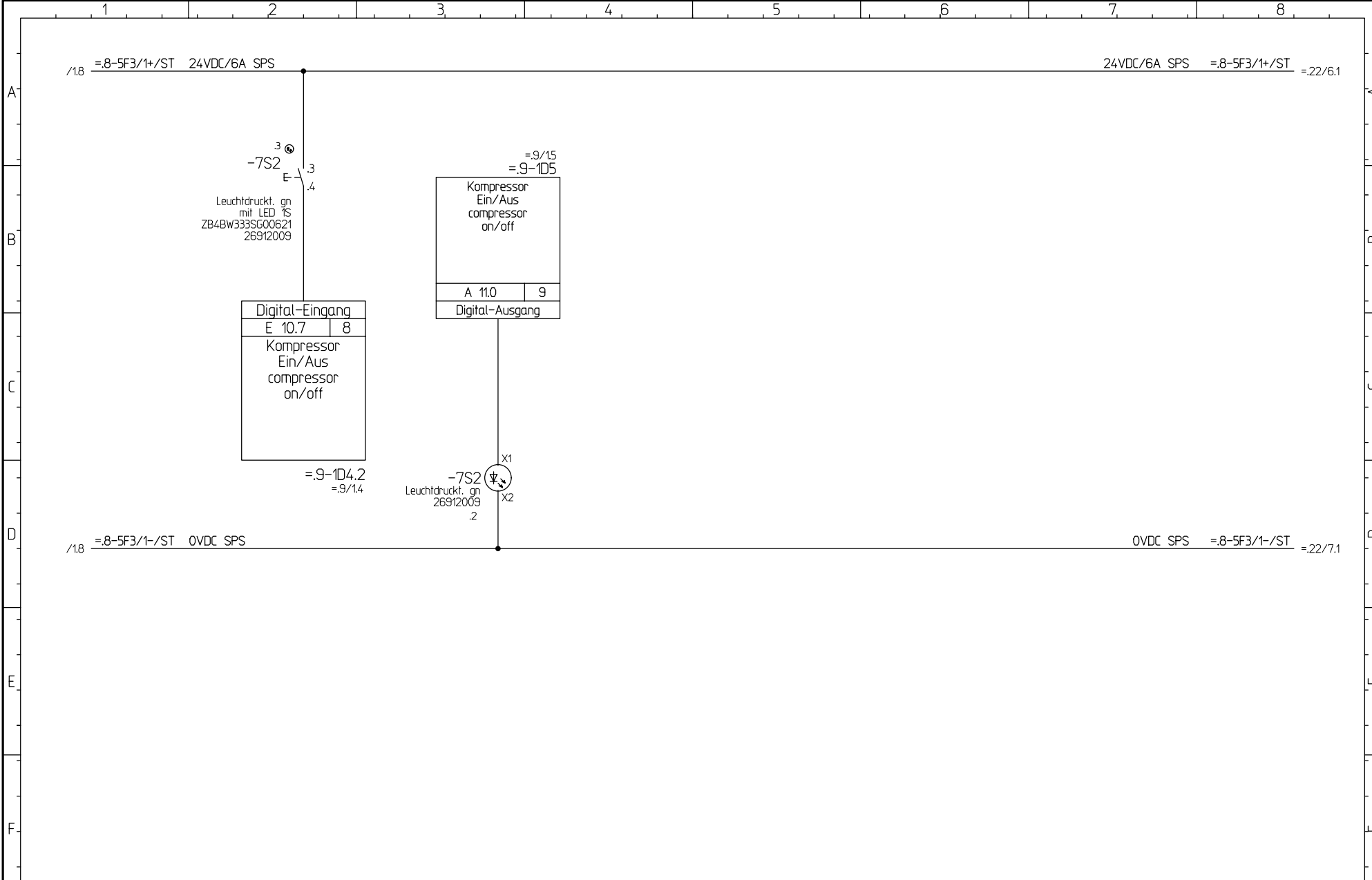

Patent-, Gebrauchsmuster- oder Geschmacksmuster-Eintragung vorbehalten. of a patent, utility model or design.
 ausdrücklich gestattet. Zwiderhandlungen verpflichten zu Schadenersatz. Alle Rechte fuer den Fall der authorisation is prohibited. Offenders will be held liable for the payment of damages. All rights reserved in the event of the grant
 Weitergabe sowie Vervielfaeltigung dieses Dokuments, Verwertung und Mitteilung seines Inhalts sind verboten, soweit nicht The reproduction, distribution and utilization of this document as well as the communication of its contents to others without express

			CAD! KEINE MANUELLEN AENDERUNGEN ! CAD! DONT CHANGE MANUAL		 Herrenknecht AG Schlehenweg 2 D-77963 Schwanau 2 Tel.: 07824 302-0 Fax: 07824 3403 Info@Herrenknecht.de	Projekt: M-1642-C =Container		Kompressor Ein/Aus compressor on/off Abgänge, Vorsicherung / outlets, prefuse		Stueckliste: parts list: 25186184		Fg.-Gruppe: funct.-group: .10		Blatt-Nr.: page-nr.: 7				
			Ausdruck-Datum: printout-date: 14.12.11			Zn.-Nr.: drawn-nr.: 3478-562-002-.10		Steuerstand Control Cabin +ST/CC		Datum: date: 26.08.2011		Bearb.: name: Th		letzte Aenderung: last modification: IB-Revision 14.12.11 Th		Blatt-Global: page-global: 83/166		von from 8

Patent-, Gebrauchsmuster- oder Geschmacksmuster-Eintragung vorbehalten.
 of a patent, utility model or design.
 ausdrucklich gestattet. Zuwiderhandlungen verpflichten zu Schadenersatz. Alle Rechte fuer den Fall der authorisation is prohibited. Offenders will be held liable for the payment of damages. All rights reserved in the event of the grant
 Weitergabe sowie Vervielfaeltigung dieses Dokuments, Verwertung und Mitteilung seines Inhalts sind verboten, soweit nicht The reproduction, distribution and utilization of this document as well as the communication of its contents to others without express

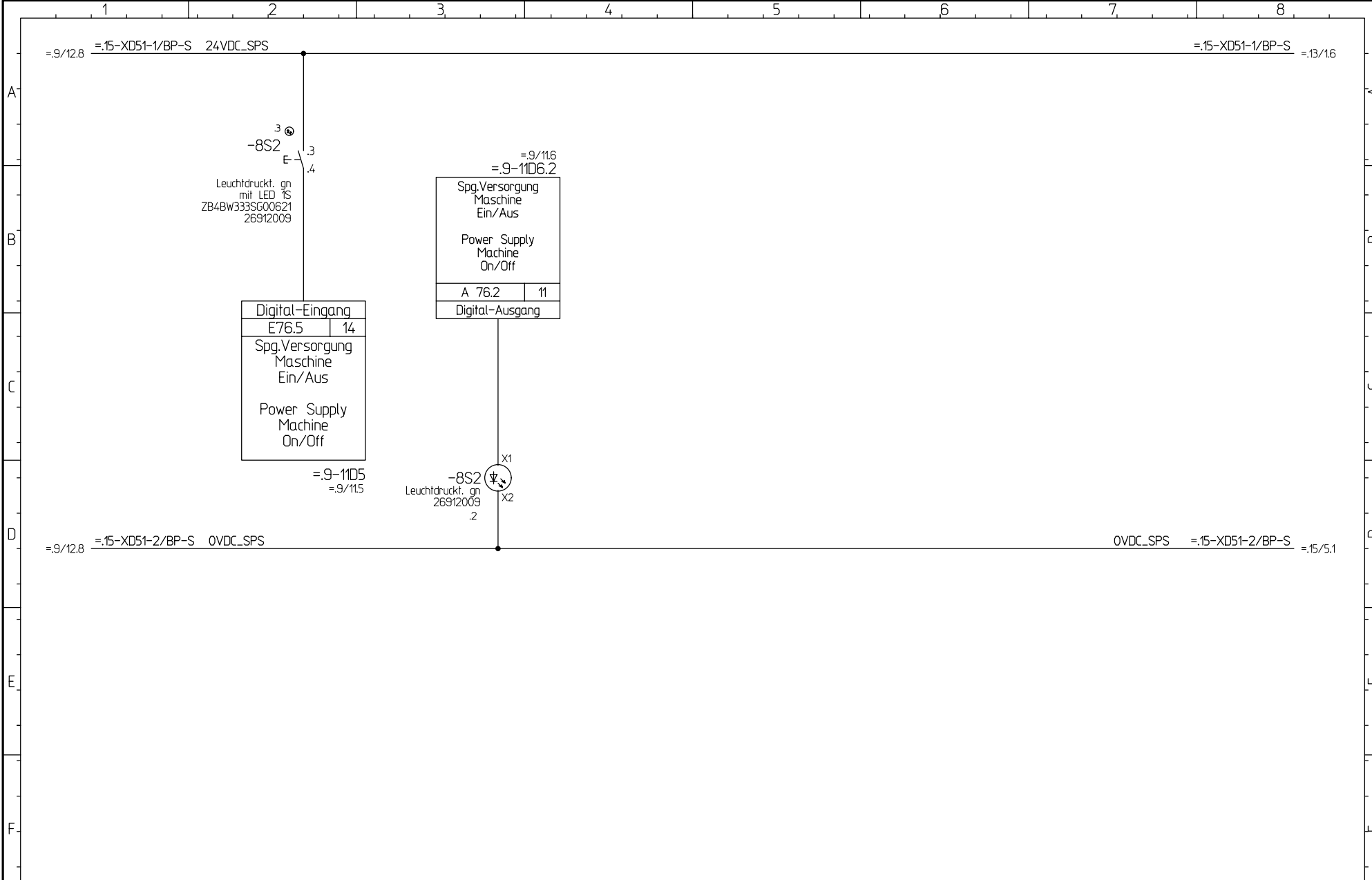



			CAD! KEINE MANUELLEN AENDERUNGEN! CAD! DONT CHANGE MANUAL		 Herrenknecht AG Schlehenweg 2 D-77963 Schwanau 2 Tel.: 07824 302-0 Fax.: 07824 3403 Info@Herrenknecht.de	Projekt: M-1642-C =Container		Spannungsvers. Maschine Ein/Aus Power Supply Machine On/Off Abgänge, Vorsicherung / outlets, prefuse		Stueckliste: parts list: 25186184		Fg.-Gruppe: funct.-group: .10		Blatt-Nr.: page-nr.: 8				
			Ausdruck-Datum: printout-date: 14.12.11			Zn.-Nr.: drawn-nr.: 3478-562-002-.10		Bedienpult Schacht control panel shaft +BP/CP-S		Datum: date: 26.08.2011		Bearb.: name: Th		letzte Aenderung: last modification: IB-Revision 14.12.11 Th		Blatt-Global: page-global: 84/166		von from 8

Patent-, Gebrauchsmuster- oder
 Geschmacksmuster-Eintragung vorbehalten.
 of a patent, utility model or design.

ausdrücklich gestattet. Zuwiderhandlungen verpflichten
 zu Schadensersatz. Alle Rechte fuer den Fall der
 Auhonisation is prohibited. Offenders will be held liable for the
 payment of damages. All rights reserved in the event of the grant

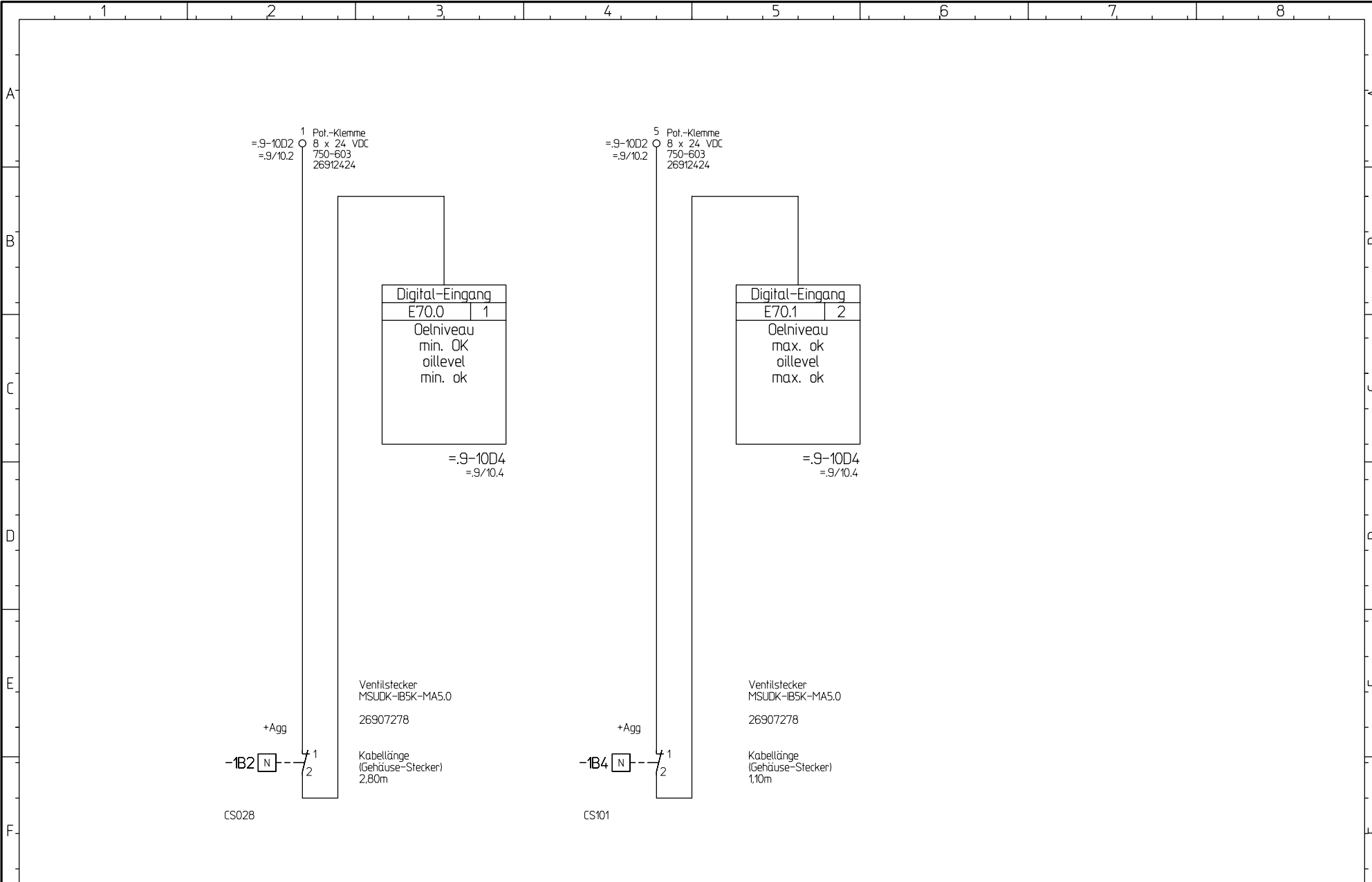
Weitergabe sowie Vervielfaeltigung dieses Dokuments, Verwertung
 und Mitteilung seines Inhalts sind verboten, soweit nicht
 The reproduction, distribution and utilization of this document as
 well as the communication of its contents to others without express



			CAD! KEINE MANUELLEN AENDERUNGEN! CAD! DONT CHANGE MANUAL		 Herrenknecht AG Schlehenweg 2 D-77963 Schwanau 2 Tel.: 07824 302-0 Fax.: 07824 3403 Info@Herrenknecht.de	Projekt: M-1642-C =Container		Oelniveau min/max ok oillevel min/max ok Filter-, Tanküberw./filter-, tank contr.		Stueckliste: parts list: 25186184		Fg.-Gruppe: funct.-group: .11		Blatt-Nr.: page-nr.: 1				
			Ausdruck-Datum: printout-date: 14.12.11			Zn.-Nr.: drawn-nr.: 3478-562-002-.11		Aggregatdose XD40 +AGG_XD40		Datum: date: 26.08.2011		Bearb.: name: Th		letzte Aenderung: last modification: IB-Revision 14.12.11 Th		Blatt-Global: page-global: 85/166		von from 6

Patent-, Gebrauchsmuster- oder Geschmacksmuster-Eintragung vorbehalten.
 of a patent, utility model or design.
 ausdrücklich gestattet. Zuwiderhandlungen verpflichten zu Schadenersatz. Alle Rechte fuer den Fall der Auhonorisation ist prohibited. Offenders will be held liable for the payment of damages. All rights reserved in the event of the grant
 Weitergabe sowie Vervielfaeltigung dieses Dokuments, Verwertung und Mitteilung seines Inhalts sind verboten, soweit nicht anders angegeben.
 The reproduction, distribution and utilization of this document as well as the communication of its contents to others without express

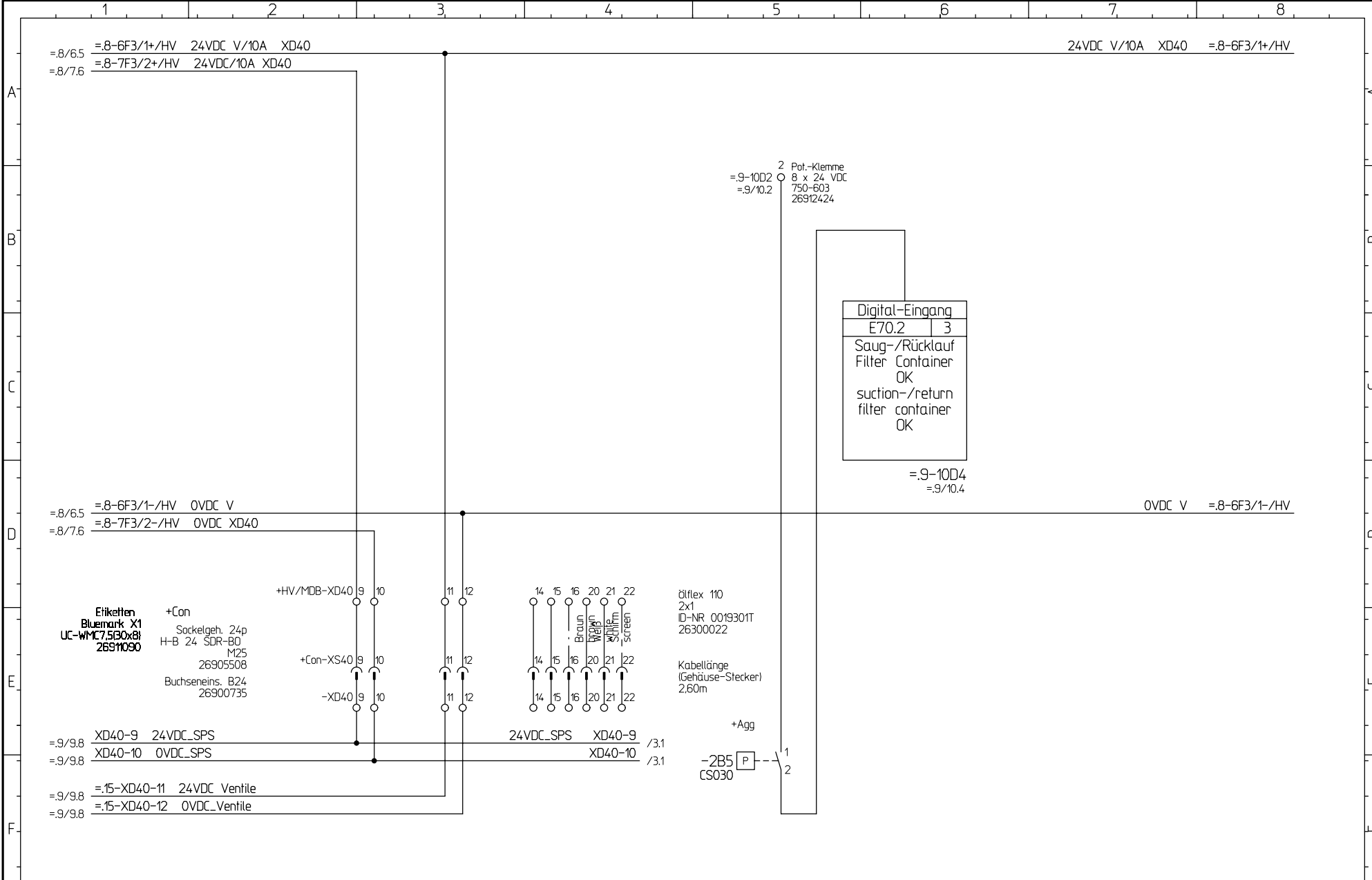

			CAD! KEINE MANUELLEN AENDERUNGEN! CAD! DONT CHANGE MANUAL		Herrenknecht AG Schlehenweg 2 D-77963 Schwanaau 2 Tel.: 07824 302-0 Fax.: 07824 3403 Info@Herrenknecht.de		Projekt: M-1642-C =Container		Saug-/Ruecklauf filter Filter-, Tanküberw./filter-, tank contr.		Stueckliste: parts list: 25186184		Fg.-Gruppe: funct.-group: .11		Blatt-Nr.: page-nr.: 2	
			Ausdruck-Datum: printout-date: 14.12.11				Zn.-Nr.: drawn-nr.: 3478-562-002-.11		Aggregatedose XD40 +AGG_XD40		Datum: date: 26.08.2011		Bearb.: name: Th		letzte Aenderung: last modification: IB-Revision 14.12.11 Th	
Index Änderung-Nr. Datum / Name Index Change No.: date / name															Blatt-Global: von page-global: 86/166 from	

Patent-, Gebrauchsmuster- oder Geschmacksmuster-Eintragung vorbehalten.
 of a patent, utility model or design.
 ausdrucklich gestattet. Zuwiderhandlungen verpflichten zu Schadensersatz. Alle Rechte fuer den Fall der Auhorisation ist prohibited. Offenders will be held liable for the payment of damages. All rights reserved in the event of the grant
 Weitergabe sowie Vervielfaeltigung dieses Dokuments, Verwertung und Mitteilung seines Inhalts sind verboten, soweit nicht The reproduction, distribution and utilization of this document as well as the communication of its contents to others without express

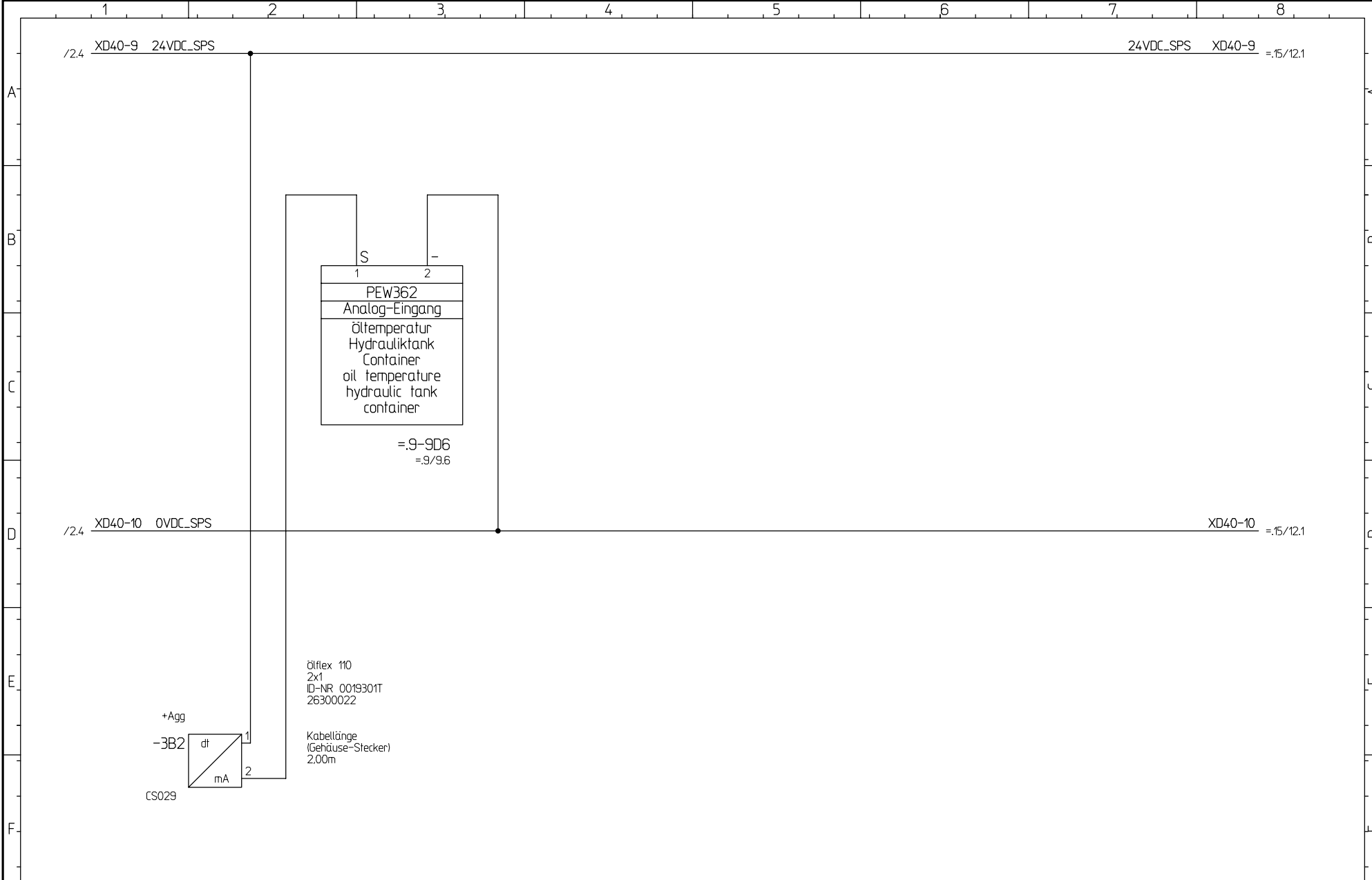



			CAD! KEINE MANUELLEN AENDERUNGEN! CAD! DONT CHANGE MANUAL		Herrenknecht AG Schlehenweg 2 D-77963 Schwanaau 2 Tel.: 07824 302-0 Fax.: 07824 3403 Info@Herrenknecht.de		Projekt: M-1642-C Tanküberwachung tank control		Stueckliste: parts list: 25186184		Fg.-Gruppe: funct.-group: .11	Blatt-Nr.: page-nr.: 3
			Ausdruck-Datum: printout-date: 14.12.11				=Container		Filter-, Tanküberw./filter-, tank contr.		Blatt-Global: page-global: 87/166	von from 6
Index	Aenderung-Nr. Change No.:	Datum / Name date / name			Zn.-Nr. drawn-nr.:	3478-562-002-.11		Aggregatedose XD40 +AGG_XD40	Datum: date: 26.08.2011	Bearb. name: Th	letzte Aenderung: last modification: IB-Revision 14.12.11 Th	

Patent-, Gebrauchsmuster- oder Geschmacksmuster-Eintragung vorbehalten.
 of a patent, utility model or design.

ausdrücklich gestattet. Zuwiderhandlungen verpflichten zu Schadensersatz. Alle Rechte fuer den Fall der Auhorisation ist prohibited. Offenders will be held liable for the payment of damages. All rights reserved in the event of the grant

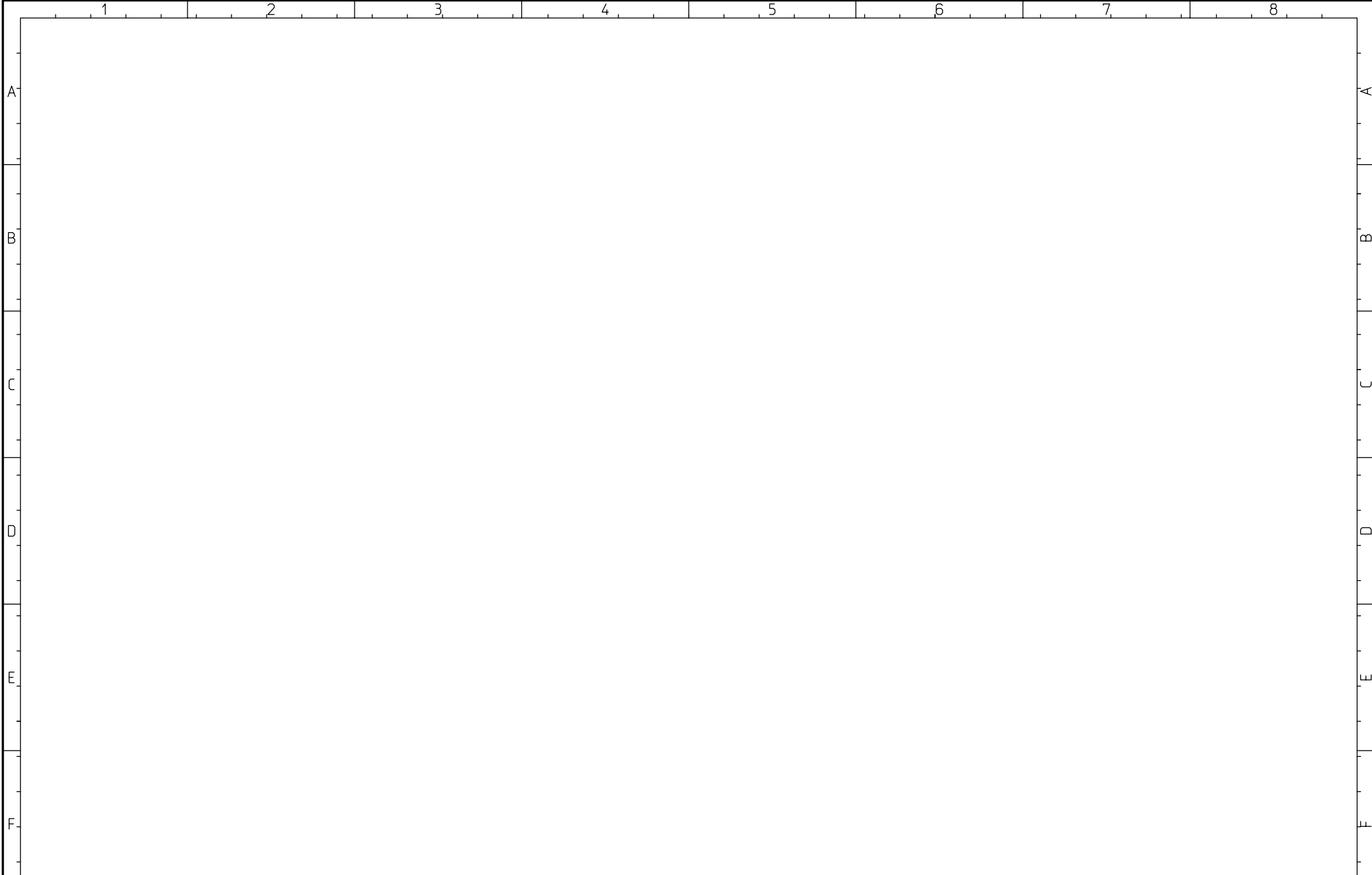
Weitergabe sowie Vervielfaeltigung dieses Dokuments, Verwertung und Mitteilung seines Inhalts sind verboten, soweit nicht The reproduction, distribution and utilization of this document as well as the communication of its contents to others without express





			CAD! KEINE MANUELLEN AENDERUNGEN ! CAD! DONT CHANGE MANUAL	 Herrenknecht AG Schlehenweg 2 D-77963 Schwanau 2 Tel.: 07824 302-0 Fax.: 07824 3403 Info@Herrenknecht.de	Projekt: project: M-1642-C	Reserve reserve	Stueckliste: parts list: 25186184	Fg.-Gruppe: funct.-group: .11	Blatt-Nr.: page-nr.: 4
Index Index	Aenderung-Nr. Change No.:	Datum / Name date / name	Ausdruck-Datum: printout-date: 14.12.11		=Container	Filter-, Tanküberw./filter-, tank contr.			Blatt-Global: page-global: 88/166
					Zn.-Nr.: drawn-nr.: 3478-562-002-.11	Datum: date: 26.08.2011	Bearb.: name: Th	letzte Aenderung: last modification: 14.12.11 Th	

Patent-, Gebrauchsmuster- oder
Geschmacksmuster-Eintragung vorbehalten.
of a patent, utility model or design.

ausdrücklich gestattet. Zuwiderhandlungen verpflichten
zu Schadensersatz. Alle Rechte fuer den Fall der
Autorisation ist prohibited. Offenders will be held liable for the
payment of damages. All rights reserved in the event of the grant

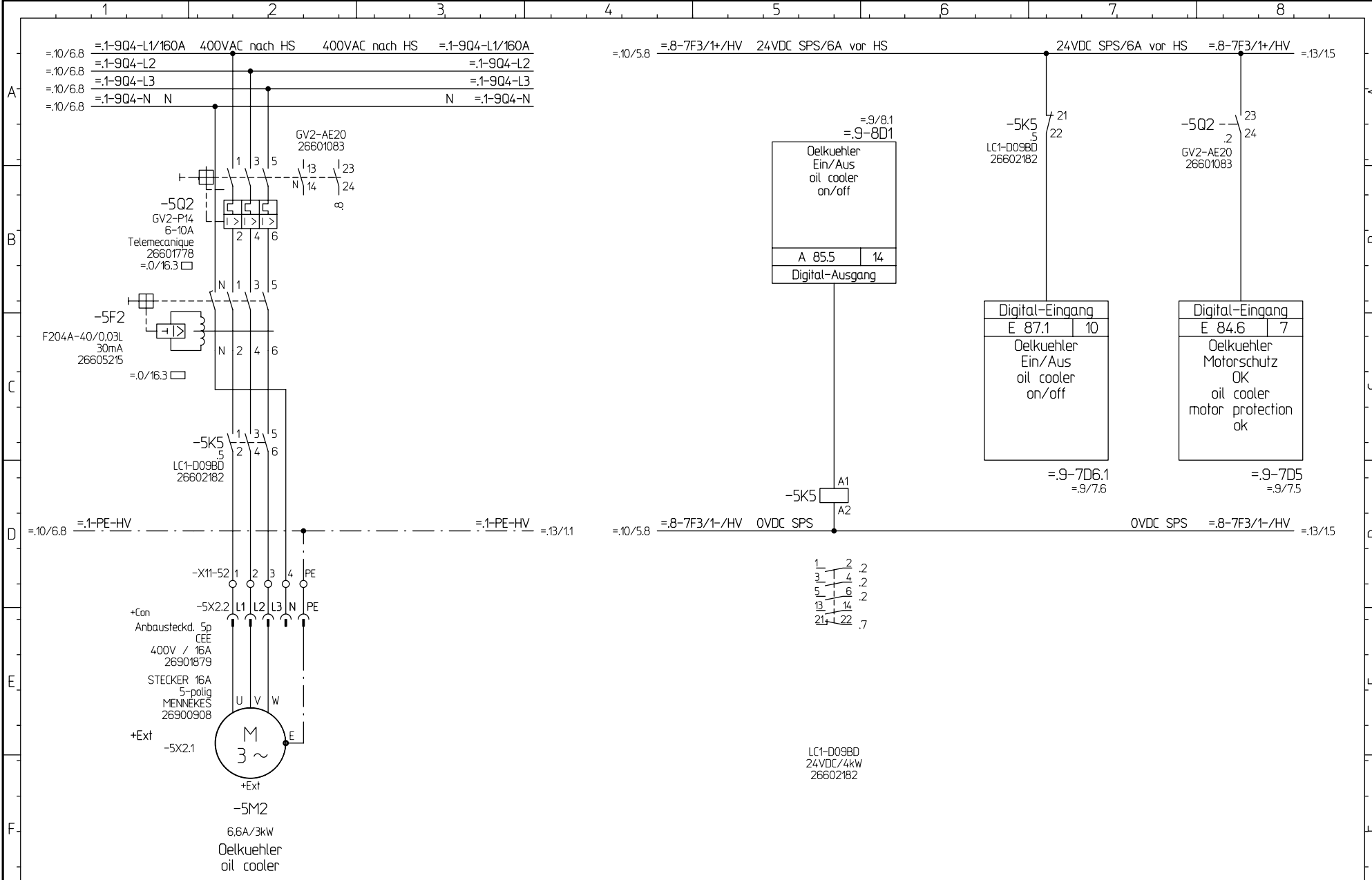
Weitergabe sowie Vervielfaeltigung dieses Dokuments, Verwertung
und Mitteilung seines Inhalts sind verboten, soweit nicht
The reproduction, distribution and utilization of this document as
well as the communication of its contents to others without express





			CAD! KEINE MANUELLEN AENDERUNGEN! CAD! DONT CHANGE MANUAL		Herrenknecht AG Schlehenweg 2 D-77963 Schwanau 2 Tel.: 07824 302-0 Fax: 07824 3403 Info@Herrenknecht.de		Projekt: project: M-1642-C		Oelkuehler 3kW oil cooler 3kW		Stueckliste: parts list: 25186184		Fg.-Gruppe: funct.-group: .11		Blatt-Nr.: page-nr.: 5	
			Ausdruck-Datum: printout-date: 14.12.11				=Container		Filter-, Tanküberw./filter-, tank contr.		Hauptverteilung main distribution board		Blatt-Global: page-global: 89/166		von from 6	
Index	Aenderung-Nr. Change No.:	Datum / Name date / name				Zn.-Nr. drawn-nr.:	3478-562-002-.11		Datum: date: 26.08.2011		Bearb. name: Th		letzte Aenderung: last modification: IB-Revision 14.12.11		Th	

Patent-, Gebrauchsmuster- oder Geschmacksmuster-Eintragung vorbehalten.
 of a patent, utility model or design.

ausdrücklich gestattet. Zuwiderhandlungen verpflichten zu Schadensersatz. Alle Rechte fuer den Fall der Autorisation ist prohibited. Offenders will be held liable for the payment of damages. All rights reserved in the event of the grant

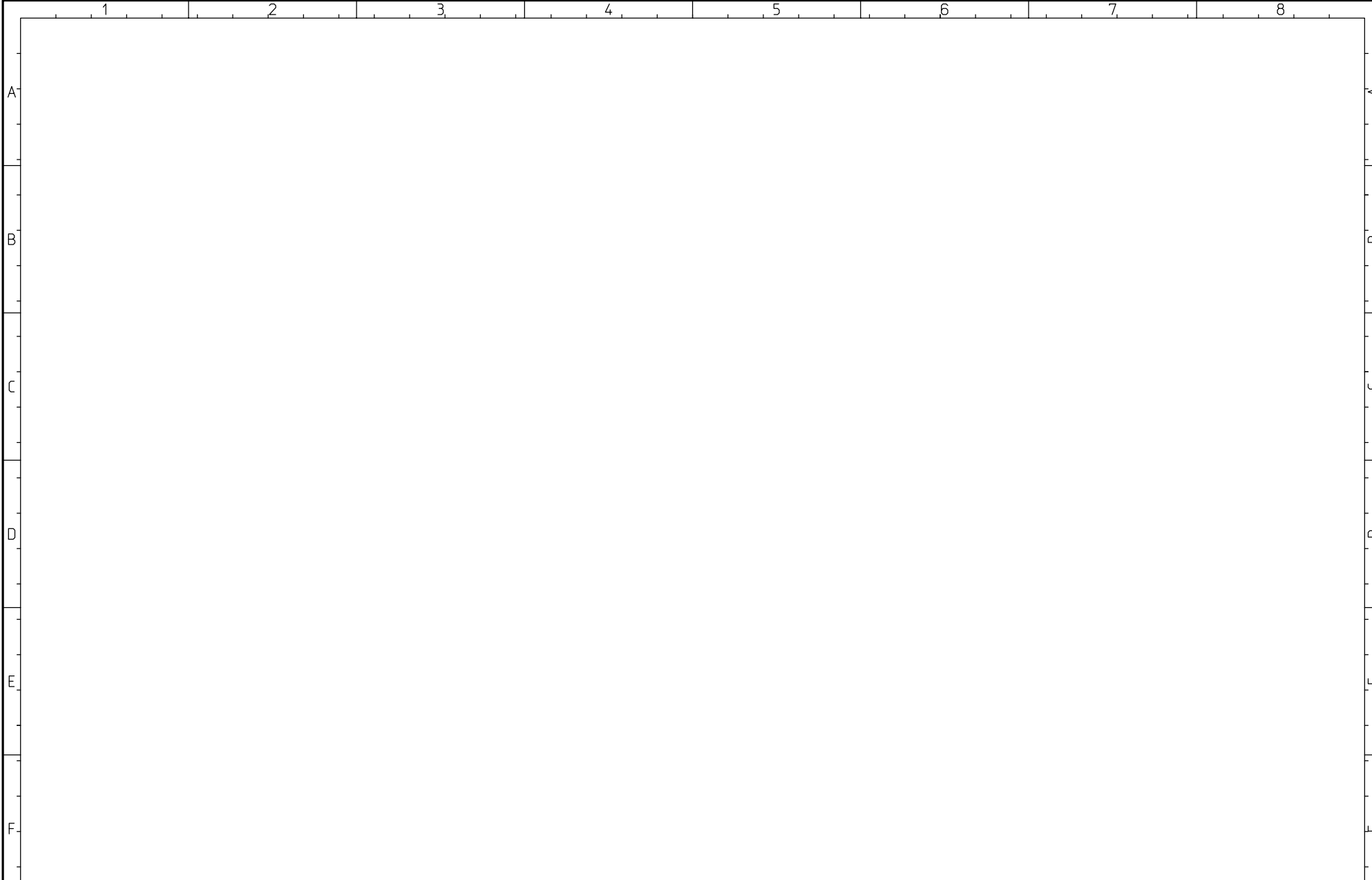
Weitergabe sowie Vervielfaeltigung dieses Dokuments, Verwertung und Mitteilung seines Inhalts sind verboten, soweit nicht The reproduction, distribution and utilization of this document as well as the communication of its contents to others without express



			CAD! KEINE MANUELLEN AENDERUNGEN! CAD! DONT CHANGE MANUAL	 Herrenknecht AG Schlehenweg 2 D-77963 Schwanau 2 Tel.: 07824 302-0 Fax.: 07824 3403 Info@Herrenknecht.de	Projekt: project: M-1642-C	Reserve reserve	Stueckliste: parts list: 25186184	Fg.-Gruppe: funct.-group: .11	Blatt-Nr.: page-nr.: 6
Index Index	Aenderung-Nr. Change No.:	Datum / Name date / name	Ausdruck-Datum: printout-date: 14.12.11		=Container	Filter-, Tanküberw./filter-, tank contr.		Blatt-Global: page-global: 90/166	von from 6
					Zn.-Nr.: drawn-nr.: 3478-562-002-.11	Datum: date: 26.08.2011	Bearb.: name: Th	letzte Aenderung: last modification: 14.12.11 Th	

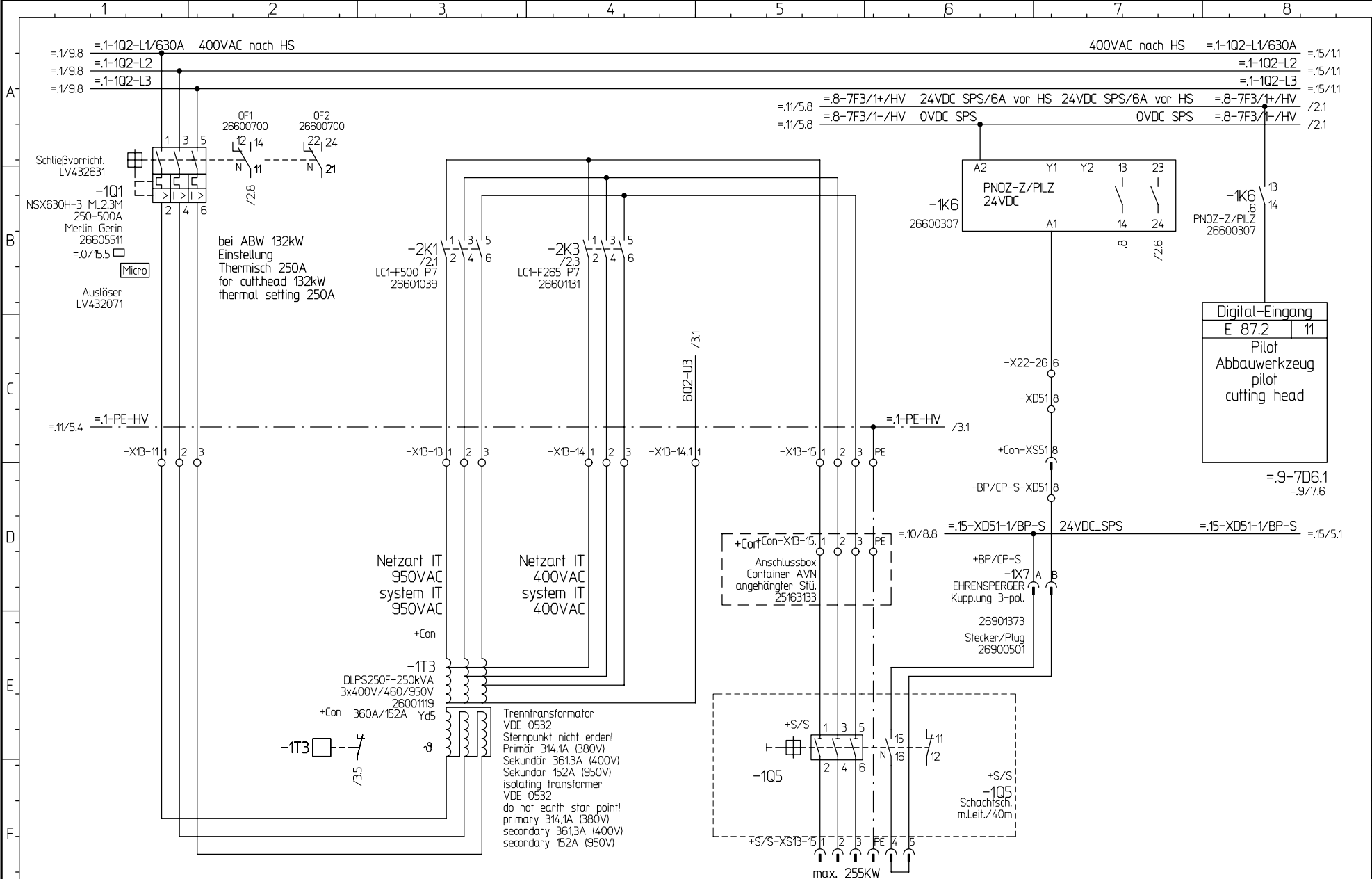

Patent-, Gebrauchsmuster- oder Geschmacksmuster-Eintragung vorbehalten.
 of a patent, utility model or design.
 ausdrucklich gestattet. Zuwiderhandlungen verpflichten zu Schadensersatz. Alle Rechte fuer den Fall der Auhonorierung ist prohibited. Offenders will be held liable for the payment of damages. All rights reserved in the event of the grant
 Weitergabe sowie Vervielfaeltigung dieses Dokuments, Verwertung und Mitteilung seines Inhalts sind verboten, soweit nicht The reproduction, distribution and utilization of this document as well as the communication of its contents to others without express

Index	Änderung-Nr. Change No.:	Datum / Name date / name
Index		

CAD! KEINE MANUELLEN
 AENDERUNGEN!
 DONT CHANGE MANUAL
 Ausdruck-Datum:
 printout-date:
 14.12.11



Herrenknecht AG
 Schlehenweg 2
 D-77963 Schwanau 2
 Tel.: 07824 302-0
 Fax.: 07824 3403
 Info@Herrenknecht.de

Projekt: project:	M-1642-C
Zn.-Nr.:	
drawn-nr.:	3478-562-002-13

Versorgung Abbauwerkzeug 950V supply cutting head 950VAC	Stueckliste: parts list:
=Container	25186184
Hauptverteilung main distribution board +HV/MDB	Datum: date:
	26.08.2011
	Bearb. name:
	Th
	letzte Aenderung: last modification:
	IB-Revision 14.12.11 Th

Fg.-Gruppe: func.-group:	Blatt-Nr.:
.13	1
Blatt-Global: page-global:	von from
91/166	4

Patent-, Gebrauchsmuster- oder
 Geschmacksmuster-Eintragung vorbehalten.
 of a patent, utility model or design.

ausdrücklich gestattet. Zuwiderhandlungen verpflichten
 zu Schadensersatz. Alle Rechte fuer den Fall der
 authorization is prohibited. Offenders will be held liable for the
 payment of damages. All rights reserved in the event of the grant

Weitergabe sowie Vervielfaeltigung dieses Dokuments, Verwertung
 und Mitteilung seines Inhalts sind verboten, soweit nicht
 The reproduction, distribution and utilization of this document as
 well as the communication of its contents to others without express

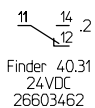
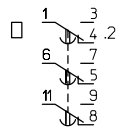
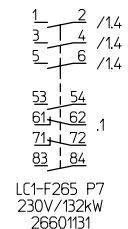
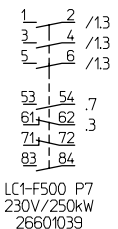
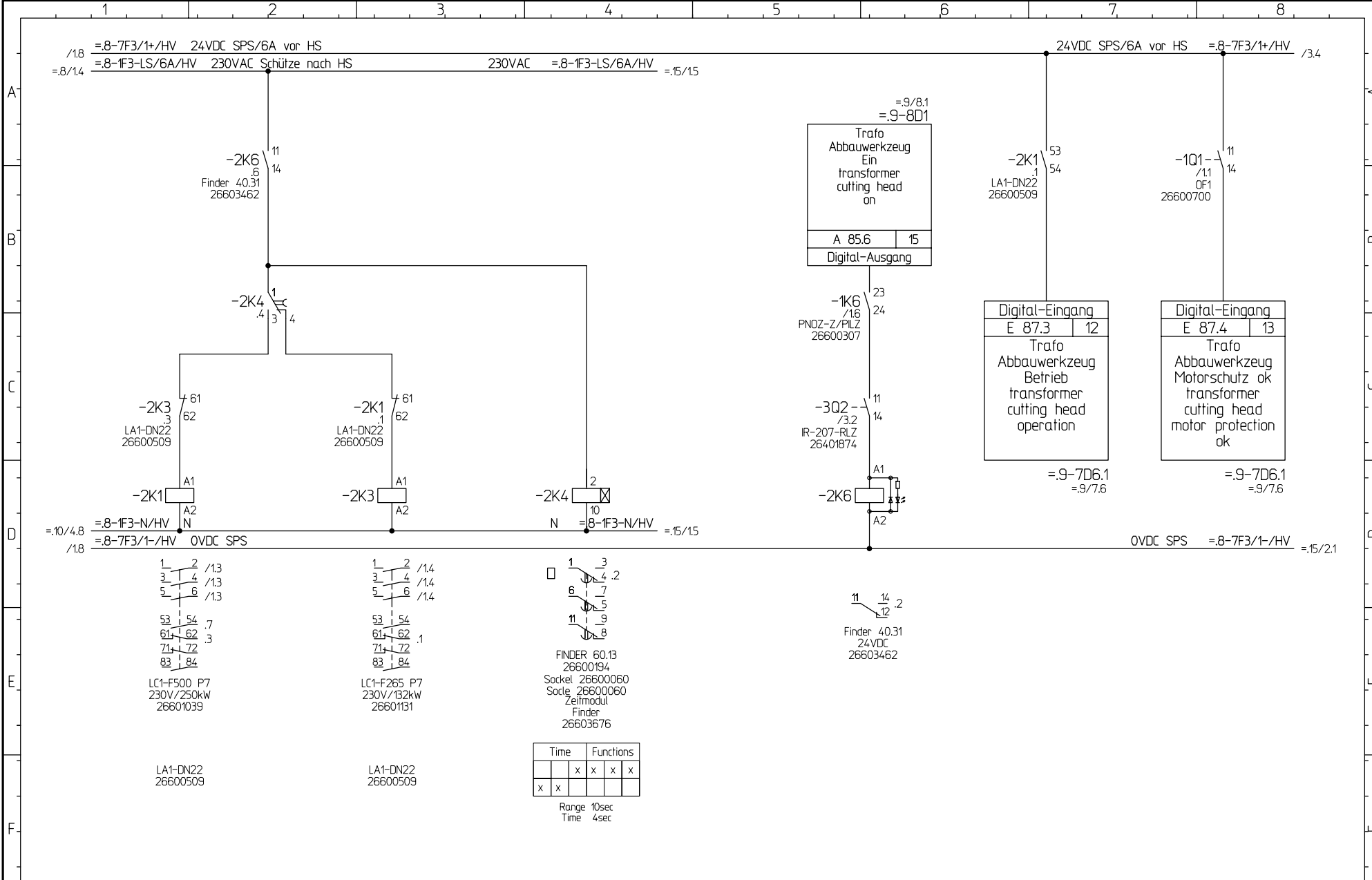

Time	Functions
	x x x x x
x x	

Range 10sec
Time 4sec

CAD! KEINE MANUELLEN AENDERUNGEN! DONT CHANGE MANUAL Ausdruck-Datum: 14.12.11 printout-date:			 Herrenknecht AG Schlehenweg 2 D-77963 Schwanau 2 Tel.: 07824 302-0 Fax.: 07824 3403 Info@Herrenknecht.de	Projekt: M-1642-C =Container		Trafo Abbauwerkzeug Betrieb transformer cutting head operation Abbauwerkzeug / cutting head		Stueckliste: 25186184 parts list:		Fg.-Gruppe: .13 funct.-group:		Blatt-Nr.: 2 page-nr.:				
Index	Aenderung-Nr. / Change No.:	Datum / Name / date / name		Zn.-Nr. / drawn-nr.: 3478-562-002-13		Hauptverteilung / main distribution board +HV/MBB		Datum: 26.08.2011 date:		Bearb.: Th name:		letzte Aenderung: 14.12.11 Th last modification:		Blatt-Global: 92/166 page-global:		von: from page-nr.:

Patent-, Gebrauchsmuster- oder Geschmacksmuster-Eintragung vorbehalten.
 of a patent, utility model or design.
 ausdrucklich gestattet. Zuwiderhandlungen verpflichten zu Schadenersatz. Alle Rechte fuer den Fall der Auhorization is prohibited. Offenders will be held liable for the payment of damages. All rights reserved in the event of the grant
 Weitergabe sowie Vervielfaeltigung dieses Dokuments, Verwertung und Mitteilung seines Inhalts sind verboten, soweit nicht The reproduction, distribution and utilization of this document as well as the communication of its contents to others without express

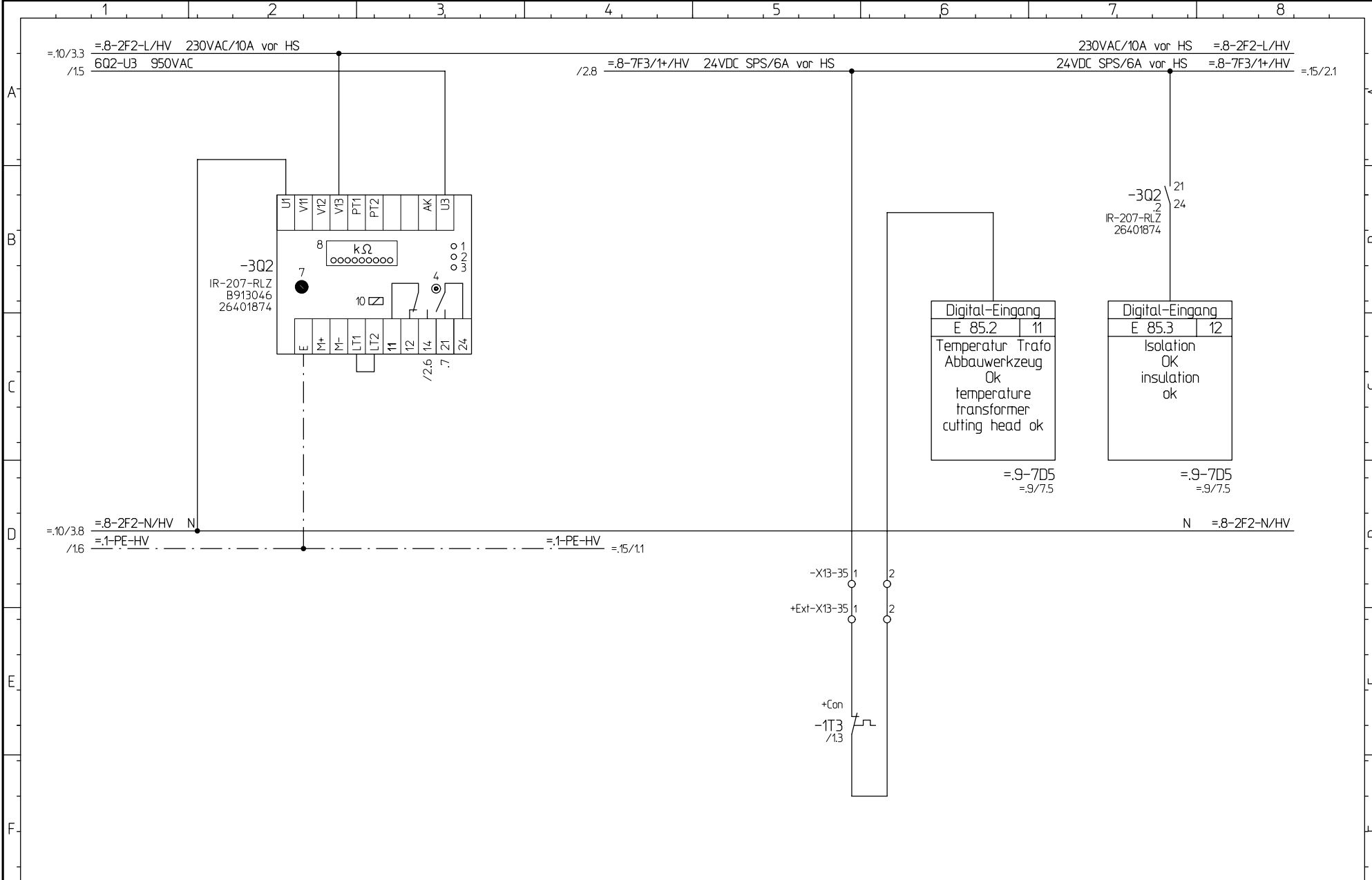



			CAD! KEINE MANUELLEN AENDERUNGEN! CAD! DONT CHANGE MANUAL		Herrenknecht AG Schlehenweg 2 D-77963 Schwanau 2 Tel.: 07824 302-0 Fax.: 07824 3403 Info@Herrenknecht.de		Projekt: M-1642-C =Container		Überwachung Trafo 950V monitoring transformer 950VAC Abbaugerzeug / cutting head		Stueckliste: parts list: 25186184		Fg.-Gruppe: funct.-group: .13		Blatt-Nr.: page-nr.: 3	
			Ausdruck-Datum: printout-date: 14.12.11				Zn.-Nr.: drawn-nr.: 3478-562-002-13		Hauptverteilung main distribution board +HV/MDB		Datum: date: 26.08.2011		Bearb.: name: Th		letzte Aenderung: last modification: IB-Revision 14.12.11 Th	
Index Index			Änderung-Nr. Change No.:												Blatt-Global: page-global: 93/166	

Patent-, Gebrauchsmuster- oder
Geschmacksmuster-Eintragung vorbehalten.
of a patent, utility model or design.

ausdrücklich gestattet. Zuwiderhandlungen verpflichten
zu Schadensersatz. Alle Rechte fuer den Fall der
Auhorisation is prohibited. Offenders will be held liable for the
payment of damages. All rights reserved in the event of the grant

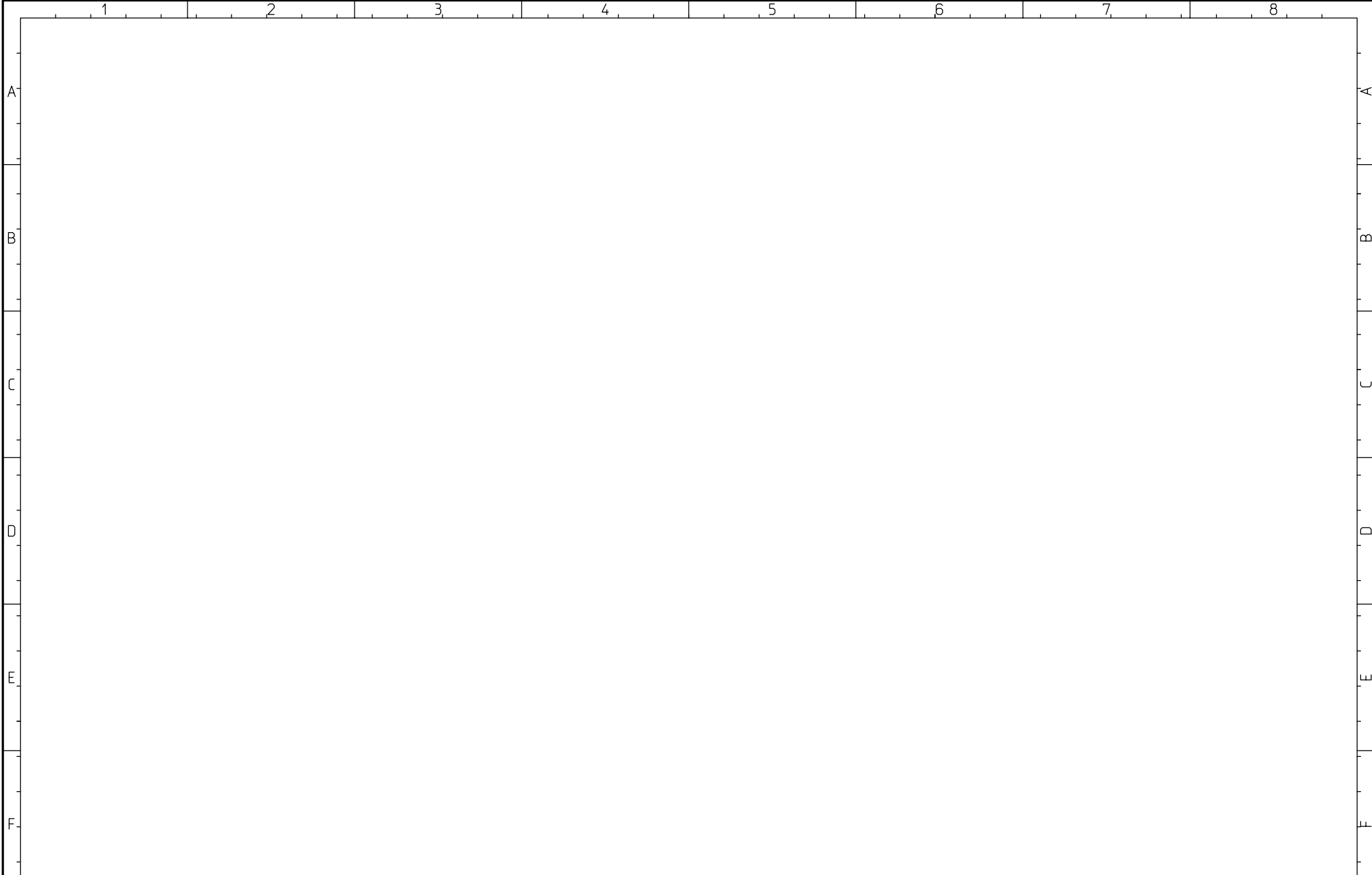
Weitergabe sowie Vervielfaeltigung dieses Dokuments, Verwertung
und Mitteilung seines Inhalts sind verboten, soweit nicht
The reproduction, distribution and utilization of this document as
well as the communication of its contents to others without express





			CAD! KEINE MANUELLEN AENDERUNGEN ! CAD! DONT CHANGE MANUAL	 Herrenknecht AG Schlehenweg 2 D-77963 Schwanau 2 Tel.: 07824 302-0 Fax.: 07824 3403 Info@Herrenknecht.de	Projekt: project: M-1642-C	Reserve reserve	Stueckliste: parts list: 25186184	Fg.-Gruppe: funct.-group: .13	Blatt-Nr.: page-nr.: 4	
Index Index	Aenderung-Nr. Change No.:	Datum / Name date / name	Ausdruck-Datum: printout-date: 14.12.11		=Container	Zn.-Nr.: drawn-nr.: 3478-562-002-13	Datum: date: 26.08.2011	Bearb.: name: Th	letzte Aenderung: last modification: 14.12.11 Th	Blatt-Global: page-global: 94/166

Patent-, Gebrauchsmuster- oder
 Geschmacksmuster-Eintragung vorbehalten.
 of a patent, utility model or design.

ausdrücklich gestattet. Zuwiderhandlungen verpflichten
 zu Schadenersatz. Alle Rechte fuer den Fall der
 Auhorization is prohibited. Offenders will be held liable for the
 payment of damages. All rights reserved in the event of the grant

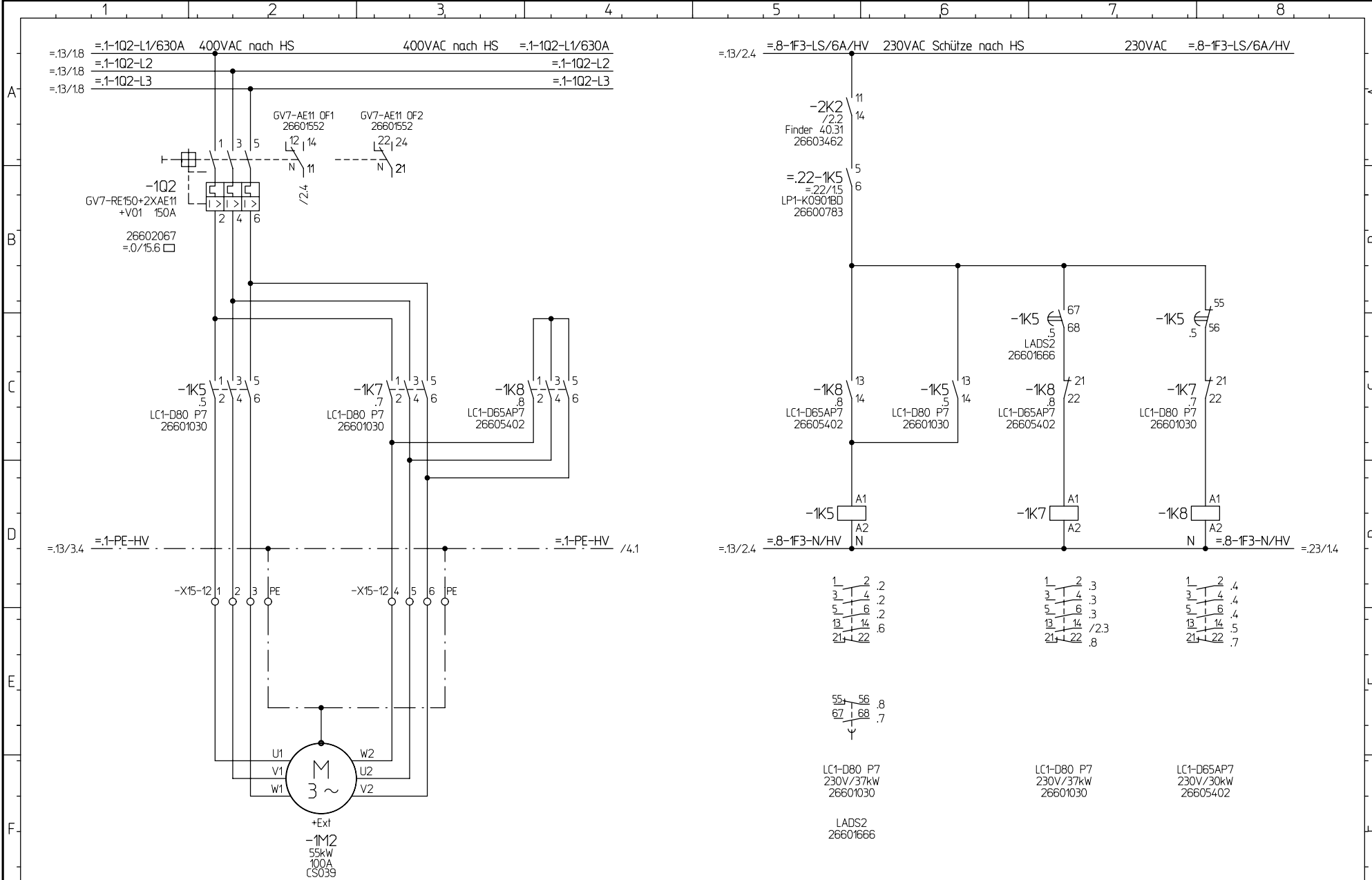
Weitergabe sowie Vervielfaeltigung dieses Dokuments, Verwertung
 und Mitteilung seines Inhalts sind verboten, soweit nicht
 The reproduction, distribution and utilization of this document as
 well as the communication of its contents to others without express



CAD! KEINE MANUELLEN AENDERUNGEN! CAD! DONT CHANGE MANUAL			 Herrenknecht AG Schlehenweg 2 D-77963 Schwanaau 2 Tel.: 07824 302-0 Fax.: 07824 3403 Info@Herrenknecht.de	Projekt: M-1642-C =Container		Vortriebspumpe 2 Container thrust pump 2 container Vortriebspr., Dehner/thrust pr., Ijack		Stueckliste: parts list: 25186184		Fg.-Gruppe: funct.-group: .15		Blatt-Nr.: page-nr.: 1				
Ausdruck-Datum: printout-date: 14.12.11				Zn.-Nr.: drawn-nr.: 3478-562-002-15		Hauptverteilung main distribution board +HV/MDB		Datum: date: 26.08.2011		Bearb.: name: Th		letzte Aenderung: last modification: IB-Revision 14.12.11 Th		Blatt-Global: page-global: 95/166		von from 18

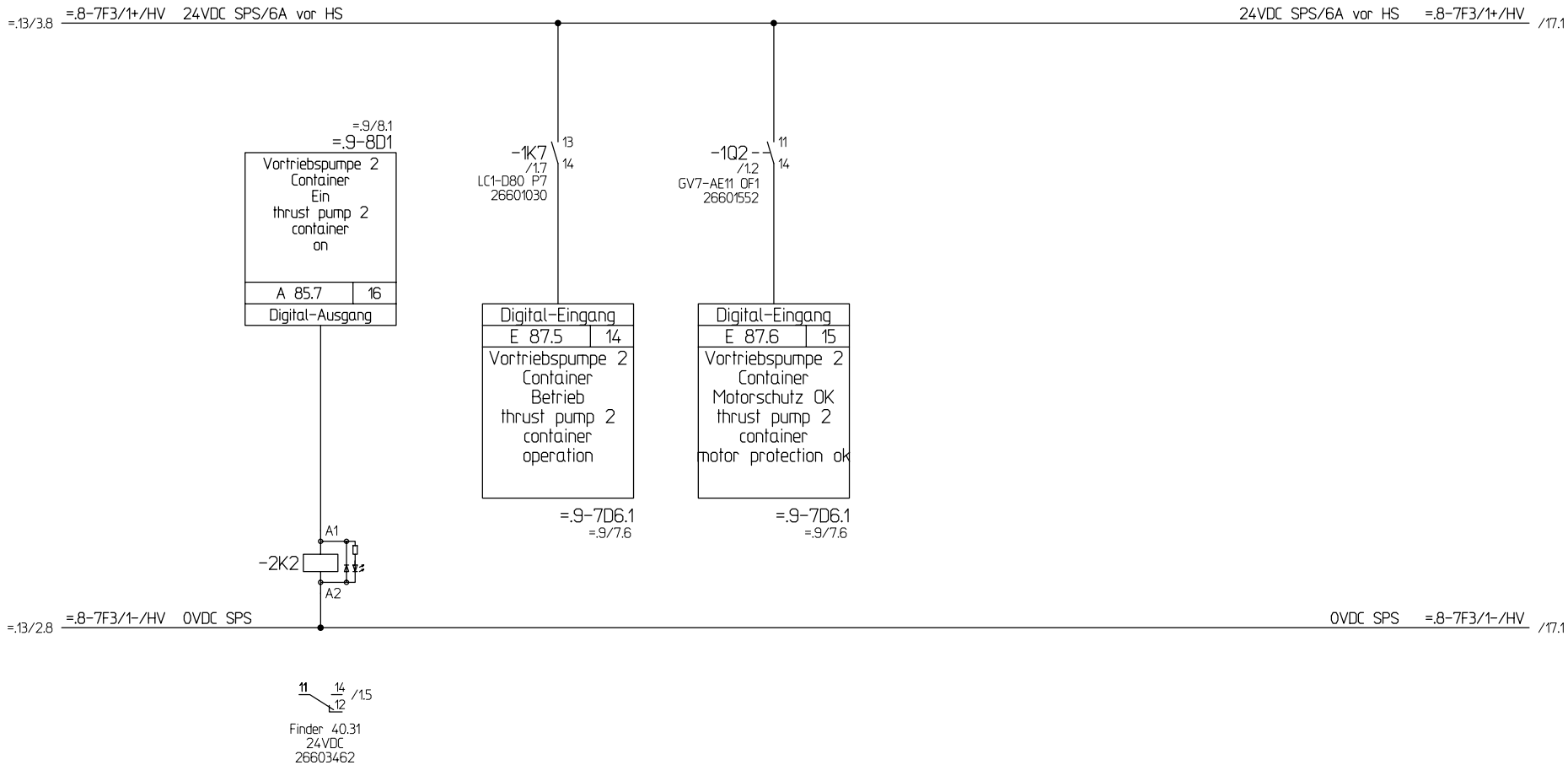

Finder 40.31
24VDC
26603462

			CAD! KEINE MANUELLEN AENDERUNGEN! CAD! DONT CHANGE MANUAL		 Herrenknecht AG Schlehenweg 2 D-77963 Schwanau 2 Tel.: 07824 302-0 Fax.: 07824 3403 Info@Herrenknecht.de	Projekt: project: M-1642-C		Vortriebspumpe 2 Container Betrieb thrust pump 2 container operation		Stueckliste: parts list: 25186184		Fg.-Gruppe: funct.-group: .15		Blatt-Nr.: page-nr.: 2	
			Ausdruck-Datum: printout-date: 14.12.11			=Container		Vortriebspr., Dehner/thrust pr., Ijack		Blatt-Global: page-global: 96/166		von from 18			
Index	Änderung-Nr. Change No.:	Datum / Name date / name				Zn.-Nr. drawn-nr.:	Hauptverteilung main distribution board +HV/MDB		Datum: date:	Bearb. name:	letzte Änderung: last modification: IB-Revision 14.12.11 Th				
						3478-562-002-15			26.08.2011	Th					

Patent-, Gebrauchsmuster- oder
 Geschmacksmuster-Eintragung vorbehalten.
 of a patent, utility model or design.

ausdrücklich gestattet. Zuwiderhandlungen verpflichten
 zu Schadensersatz. Alle Rechte fuer den Fall der
 authorisation is prohibited. Offenders will be held liable for the
 payment of damages. All rights reserved in the event of the grant

Weitergabe sowie Vervielfaeltigung dieses Dokuments, Verwertung
 und Mitteilung seines Inhalts sind verboten, soweit nicht
 The reproduction, distribution and utilization of this document as
 well as the communication of its contents to others without express

Patent-, Gebrauchsmuster- oder
Geschmacksmuster-Eintragung vorbehalten.
of a patent, utility model or design.

ausdrücklich gestattet. Zuwiderhandlungen verpflichten
zu Schadensersatz. Alle Rechte fuer den Fall der
Auhorisation is prohibited. Offenders will be held liable for the
payment of damages. All rights reserved in the event of the grant

Weitergabe sowie Vervielfaeltigung dieses Dokuments, Verwertung
und Mitteilung seines Inhalts sind verboten, soweit nicht
The reproduction, distribution and utilization of this document as
well as the communication of its contents to others without express

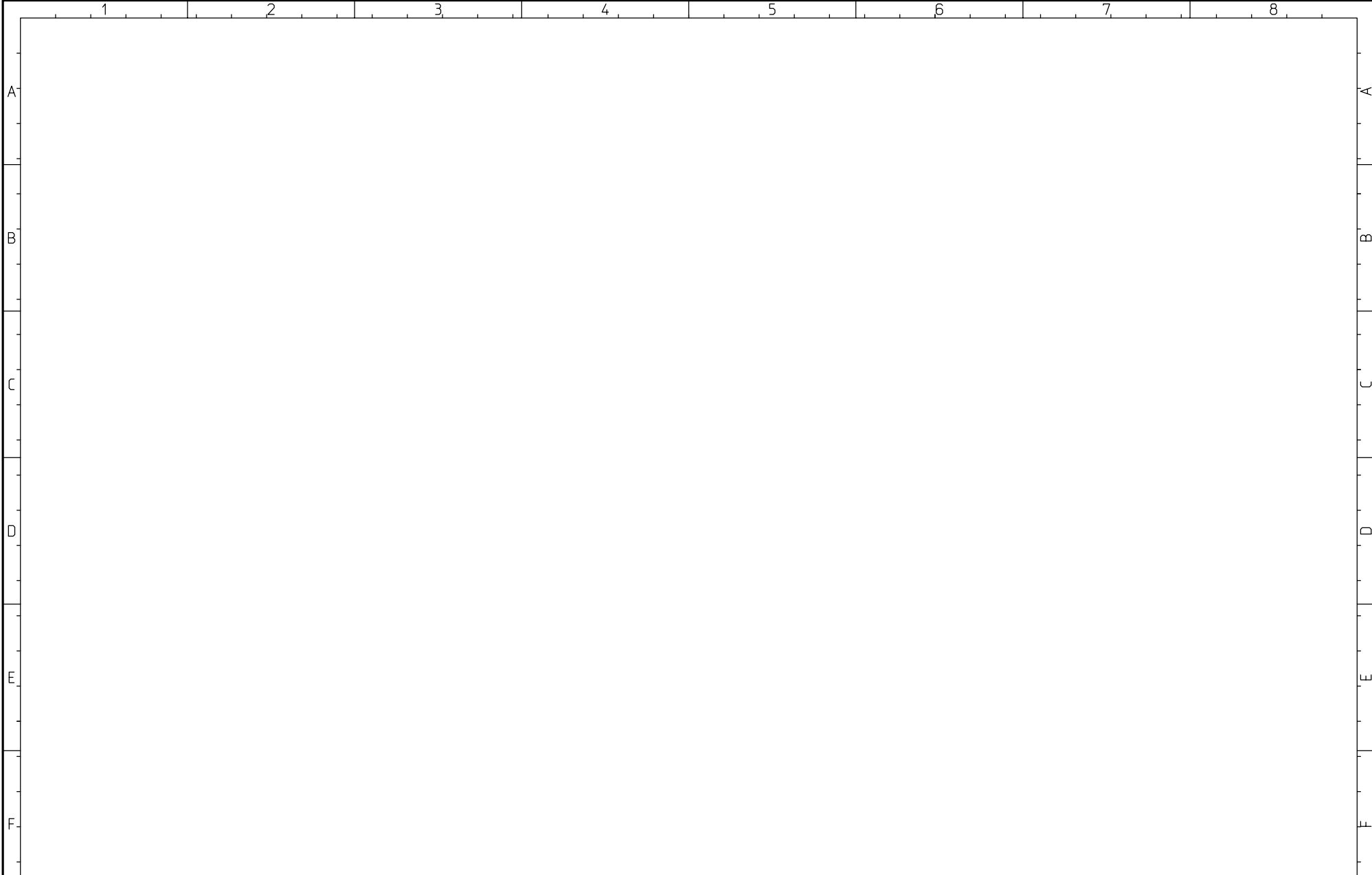

			CAD! KEINE MANUELLEN AENDERUNGEN ! CAD! DONT CHANGE MANUAL	 Herrenknecht AG Schlehenweg 2 D-77963 Schwanau 2 Tel.: 07824 302-0 Fax.: 07824 3403 Info@Herrenknecht.de	Projekt: project: M-1642-C	Reserve reserve	Stueckliste: parts list: 25186184	Fg.-Gruppe: funct.-group: .15	Blatt-Nr.: page-nr.: 3
Index Index	Aenderung-Nr. Change No.:	Datum / Name date / name	Ausdruck-Datum: printout-date: 14.12.11		=Container	Vortriebspr., Dehner/thrust pr., Ijack			Blatt-Global: page-global: 97/166
					Zn.-Nr.: drawn-nr.: 3478-562-002-.15	Datum: date: 26.08.2011	Bearb.: name: Th	letzte Aenderung: last modification: IB-Revision 14.12.11 Th	

Patent-, Gebrauchsmuster- oder
Geschmacksmuster-Eintragung vorbehalten.
of a patent, utility model or design.

ausdrücklich gestattet. Zuwiderhandlungen verpflichten
zu Schadenersatz. Alle Rechte fuer den Fall der
Auhonization is prohibited. Offenders will be held liable for the
payment of damages. All rights reserved in the event of the grant

Weitergabe sowie Vervielfaeltigung dieses Dokuments, Verwertung
und Mitteilung seines Inhalts sind verboten, soweit nicht
The reproduction, distribution and utilization of this document as
well as the communication of its contents to others without express

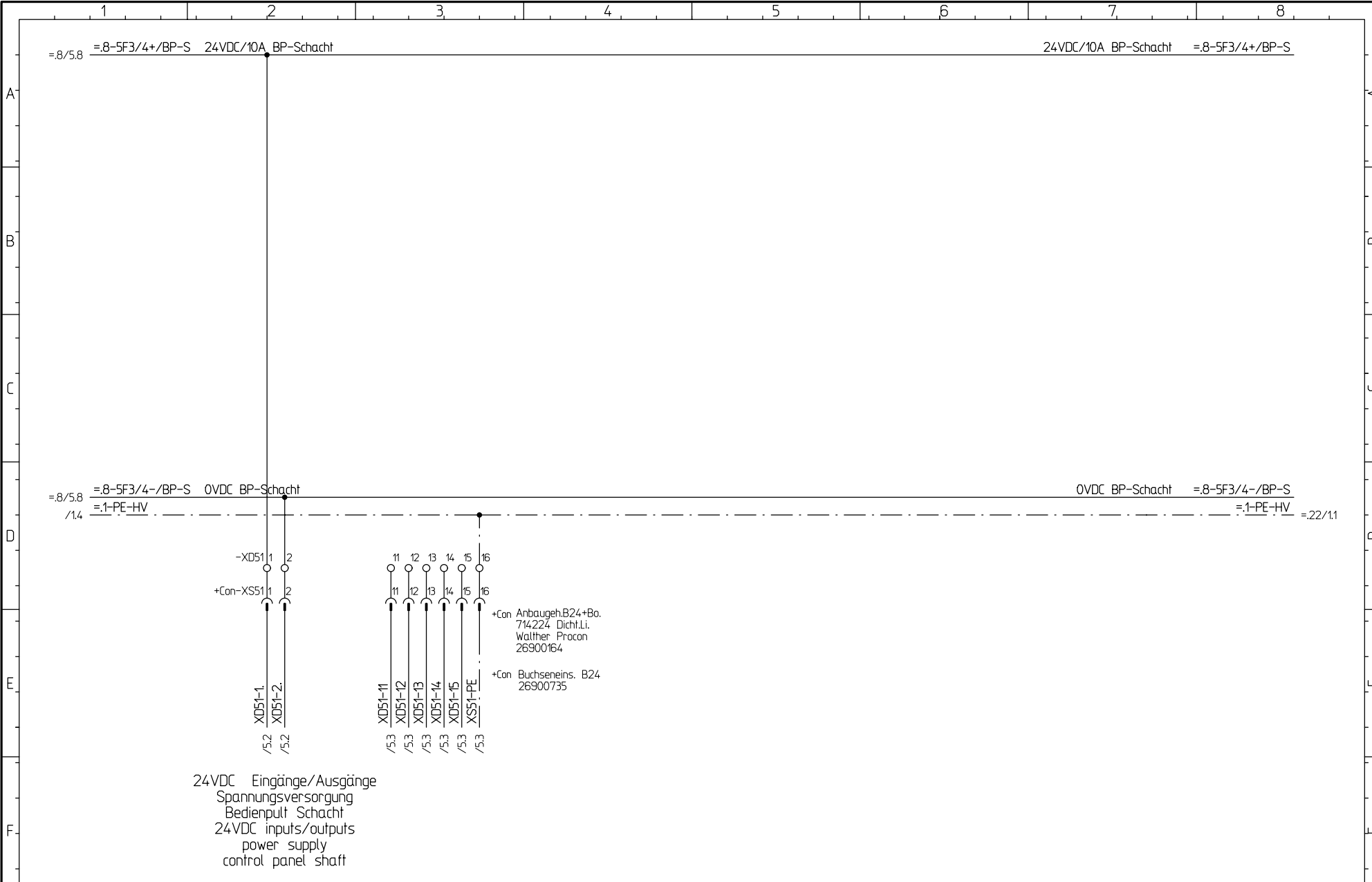

24VDC Eingänge/Ausgänge
Spannungsversorgung
Bedienpult Schacht
24VDC inputs/outputs
power supply
control panel shaft

			CAD! KEINE MANUELLEN AENDERUNGEN! CAD! DONT CHANGE MANUAL		Herrenknecht AG Schlehenweg 2 D-77963 Schwanaau 2 Tel.: 07824 302-0 Fax.: 07824 3403 Info@Herrenknecht.de		Projekt: project: M-1642-C		Spannungsversorgung BP-Schacht power supply CP-shaft		Stueckliste: parts list: 25186184	Fg.-Gruppe: funct.-group: .15	Blatt-Nr.: page-nr.: 4
			Ausdruck-Datum: printout-date: 14.12.11				=Container		Vortriebspr., Dehner/thrust pr., Ijjack				
Index Index	Änderung-Nr. Change No.:	Datum / Name date / name							Zn.-Nr.: drawn-nr.: 3478-562-002-15	Hauptverteilung main distribution board +HV/MDB	Datum: date: 26.08.2011	Bearb.: name: Th	letzte Aenderung: last modification: 14.12.11 Th

Patent-, Gebrauchsmuster- oder Geschmacksmuster-Eintragung vorbehalten. of a patent, utility model or design.
 ausdrucklich gestattet. Zuwiderhandlungen verpflichten zu Schadensersatz. Alle Rechte fuer den Fall der authorisation is prohibited. Offenders will be held liable for the payment of damages. All rights reserved in the event of the grant
 Weitergabe sowie Vervielfaeltigung dieses Dokuments, Verwertung und Mitteilung seines Inhalts sind verboten, soweit nicht The reproduction, distribution and utilization of this document as well as the communication of its contents to others without express

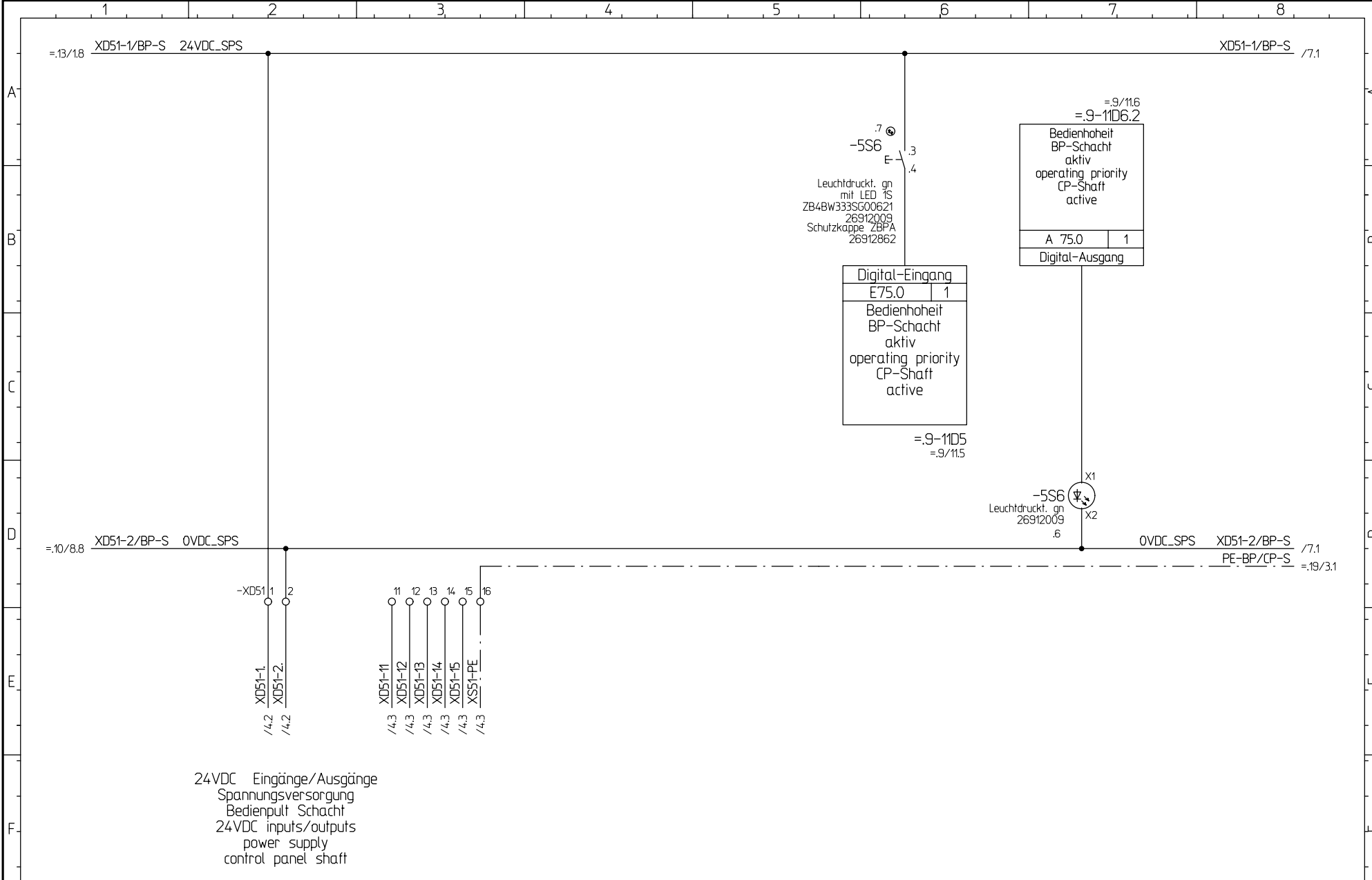



			CAD! KEINE MANUELLEN AENDERUNGEN! CAD! DONT CHANGE MANUAL		Herrenknecht AG Schlehenweg 2 D-77963 Schwanau 2 Tel.: 07824 302-0 Fax.: 07824 3403 Info@Herrenknecht.de		Projekt: M-1642-C =Container		Spannungsversorgung BP-Schacht power supply CP-shaft Vortriebspr., Dehner/thrust pr., Ijack		Stueckliste: parts list: 25186184		Fg.-Gruppe: funct.-group: .15		Blatt-Nr.: page-nr.: 5					
			Ausdruck-Datum: printout-date: 14.12.11				Zn.-Nr.: drawn-nr.: 3478-562-002-15		Bedienpult Schacht control panel shaft +BP/CP-S		Datum: date: 26.08.2011		Bearb.: name: Th		letzte Aenderung: last modification: IB-Revision 14.12.11 Th		Blatt-Global: page-global: 99/166		von from 18	

Patent-, Gebrauchsmuster- oder
Geschmacksmuster-Eintragung vorbehalten.
of a patent, utility model or design.

ausdrücklich gestattet. Zuwiderhandlungen verpflichten
zu Schadensersatz. Alle Rechte fuer den Fall der
Auhorisation is prohibited. Offenders will be held liable for the
payment of damages. All rights reserved in the event of the grant

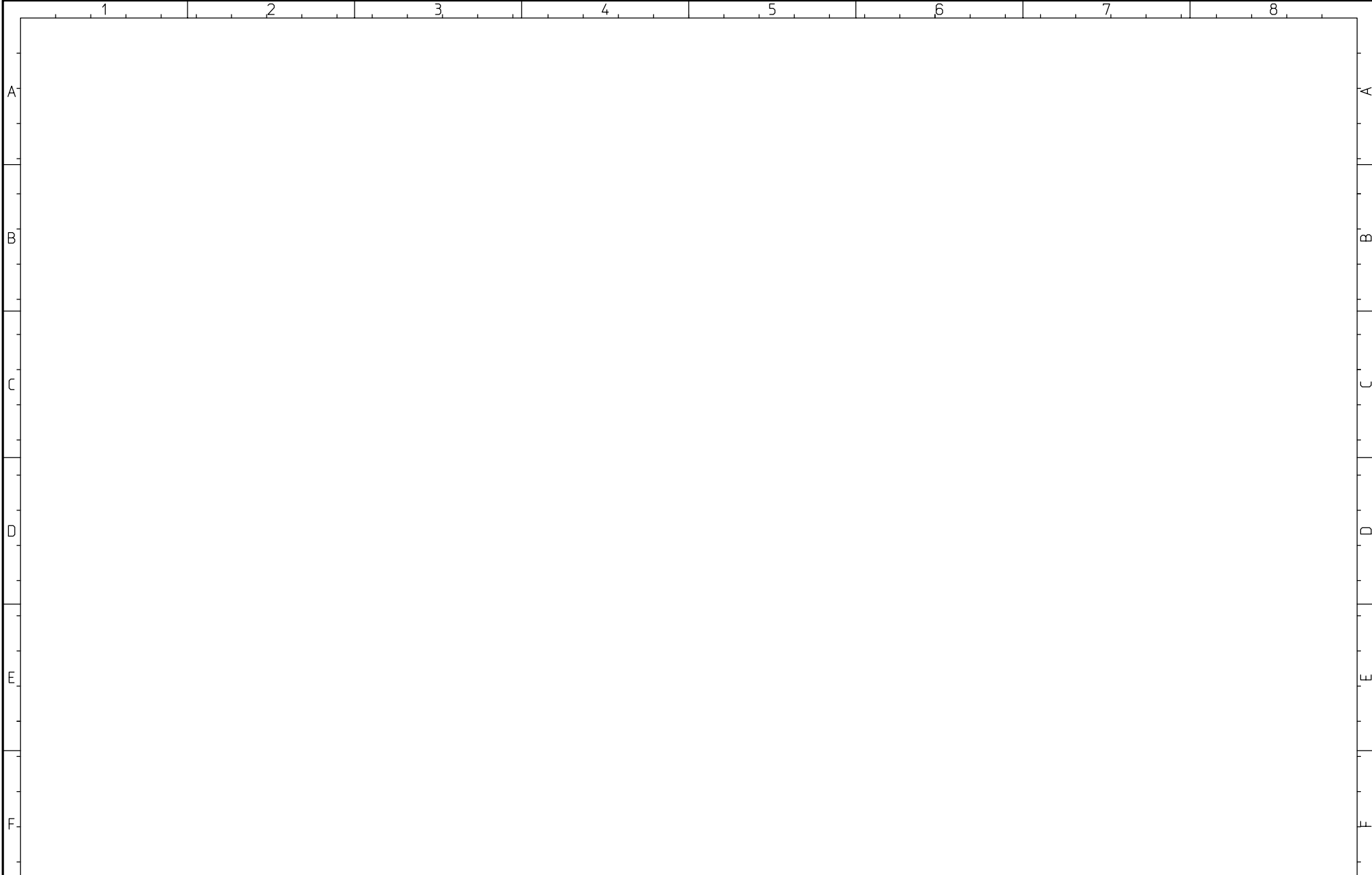
Weitergabe sowie Vervielfaeltigung dieses Dokuments, Verwertung
und Mitteilung seines Inhalts sind verboten, soweit nicht
The reproduction, distribution and utilization of this document as
well as the communication of its contents to others without express



			CAD! KEINE MANUELLEN AENDERUNGEN ! CAD! DONT CHANGE MANUAL	 Herrenknecht AG Schlehenweg 2 D-77963 Schwanau 2 Tel.: 07824 302-0 Fax.: 07824 3403 Info@Herrenknecht.de	Projekt: project: M-1642-C	Reserve reserve	Stueckliste: parts list: 25186184	Fg.-Gruppe: funct.-group: .15	Blatt-Nr.: page-nr.: 6
Index Index	Aenderung-Nr. Change No.:	Datum / Name date / name	Ausdruck-Datum: printout-date: 14.12.11		=Container	Vortriebspr., Dehner/thrust pr., Ijack			Blatt-Global: page-global: 100/166
					Zn.-Nr.: drawn-nr.: 3478-562-002-15	Datum: date: 26.08.2011	Bearb.: name: Th	letzte Aenderung: last modification: 14.12.11 Th	

Patent-, Gebrauchsmuster- oder Geschmacksmuster-Eintragung vorbehalten.
 of a patent, utility model or design.
 ausdrucklich gestattet. Zuwiderhandlungen verpflichten zu Schadenersatz. Alle Rechte fuer den Fall der Auhorisation ist prohibited. Offenders will be held liable for the payment of damages. All rights reserved in the event of the grant
 Weitergabe sowie Vervielfaeltigung dieses Dokuments, Verwertung und Mitteilung seines Inhalts sind verboten, soweit nicht The reproduction, distribution and utilization of this document as well as the communication of its contents to others without express

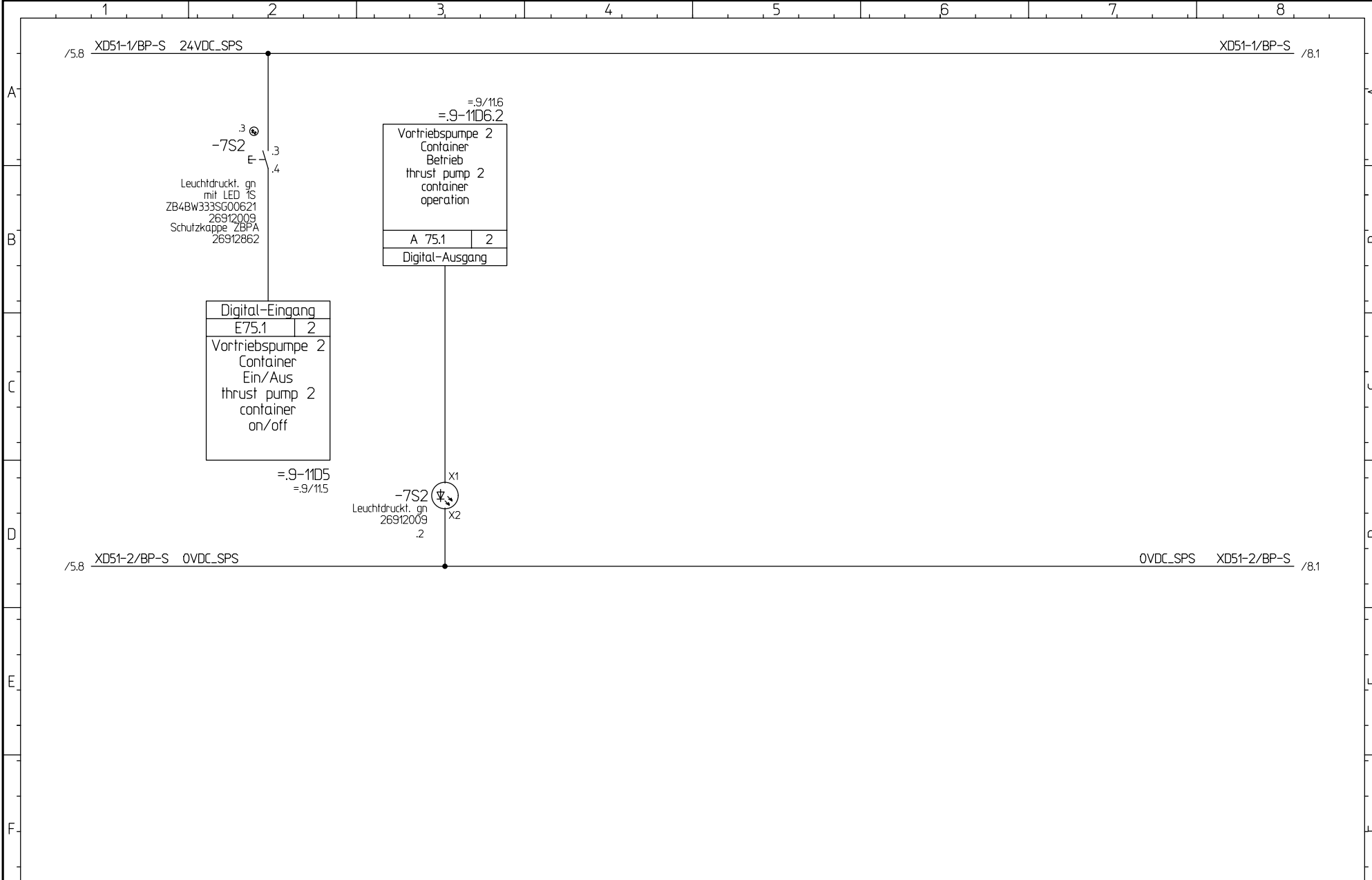

			CAD! KEINE MANUELLEN AENDERUNGEN! CAD! DONT CHANGE MANUAL		Herrenknecht AG Schlehenweg 2 D-77963 Schwanau 2 Tel.: 07824 302-0 Fax.: 07824 3403 Info@Herrenknecht.de		Projekt: M-1642-C project: =Container		Vortriebspumpe 2 Container Ein/Aus thrust pump 2 container on/off Vortriebspr., Dehner/thrust pr., Ijack		Stueckliste: parts list: 25186184		Fg.-Gruppe: funct.-group: .15 Blatt-Nr.: page-nr.: 7	
			Ausdruck-Datum: printout-date: 14.12.11				Zn.-Nr.: drawn-nr.: 3478-562-002-15		Bedienpult Schacht control panel shaft +BP/CP-S		Datum: date: 26.08.2011		Bearb.: name: Th	
									letzte Aenderung: last modification: 14.12.11 Th		Blatt-Global: page-global: 101/166		von: from 18	

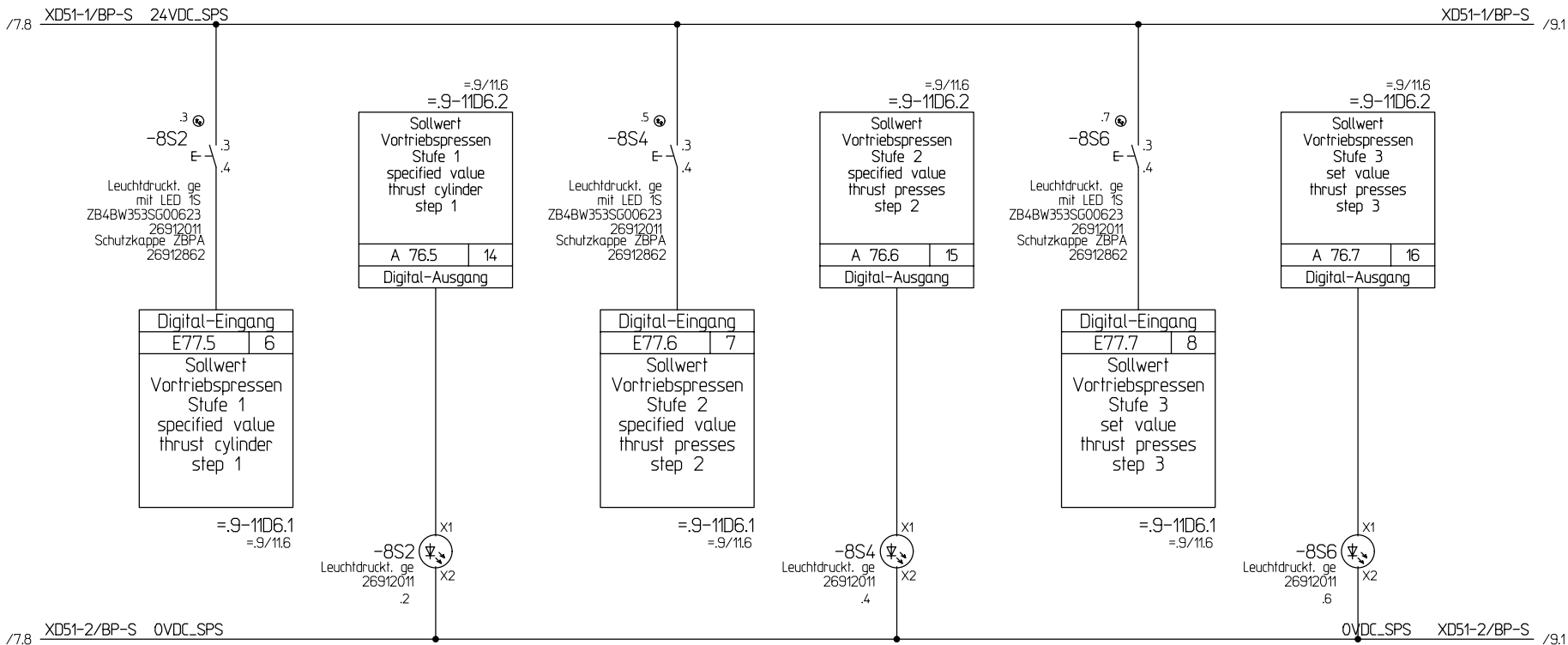

Patent-, Gebrauchsmuster- oder Geschmacksmuster-Eintragung vorbehalten. of a patent, utility model or design.
 ausdrucklich gestattet. Zuwiderhandlungen verpflichten zu Schadenersatz. Alle Rechte fuer den Fall der Auhorisation is prohibited. Offenders will be held liable for the payment of damages. All rights reserved in the event of the grant
 Weitergabe sowie Vervielfaeltigung dieses Dokuments, Verwertung und Mitteilung seines Inhalts sind verboten, soweit nicht The reproduction, distribution and utilization of this document as well as the communication of its contents to others without express

			CAD! KEINE MANUELLEN AENDERUNGEN ! CAD! DONT CHANGE MANUAL		 Herrenknecht AG Schleenweg 2 D-77963 Schwanau 2 Tel.: 07824 302-0 Fax.: 07824 3403 Info@Herrenknecht.de	Projekt: M-1642-C =Container		Sollwert Vortriebspressen Schachtpult Specified value thrust cylinder shaft panel Vortriebspr., Dehner/thrust pr., ljack		Stueckliste: parts list: 25186184		Fg.-Gruppe: funct.-group: .15		Blatt-Nr.: page-nr.: 8				
			Ausdruck-Datum: printout-date: 14.12.11			Zn.-Nr.: drawn-nr.: 3478-562-002-15		Bedienpult Schacht control panel shaft +BP/CP-S		Datum: date: 26.08.2011		Bearb.: name: Th		letzte Aenderung: last modification: IB-Revision 14.12.11 Th		Blatt-Global: page-global: 102/166		von from 18

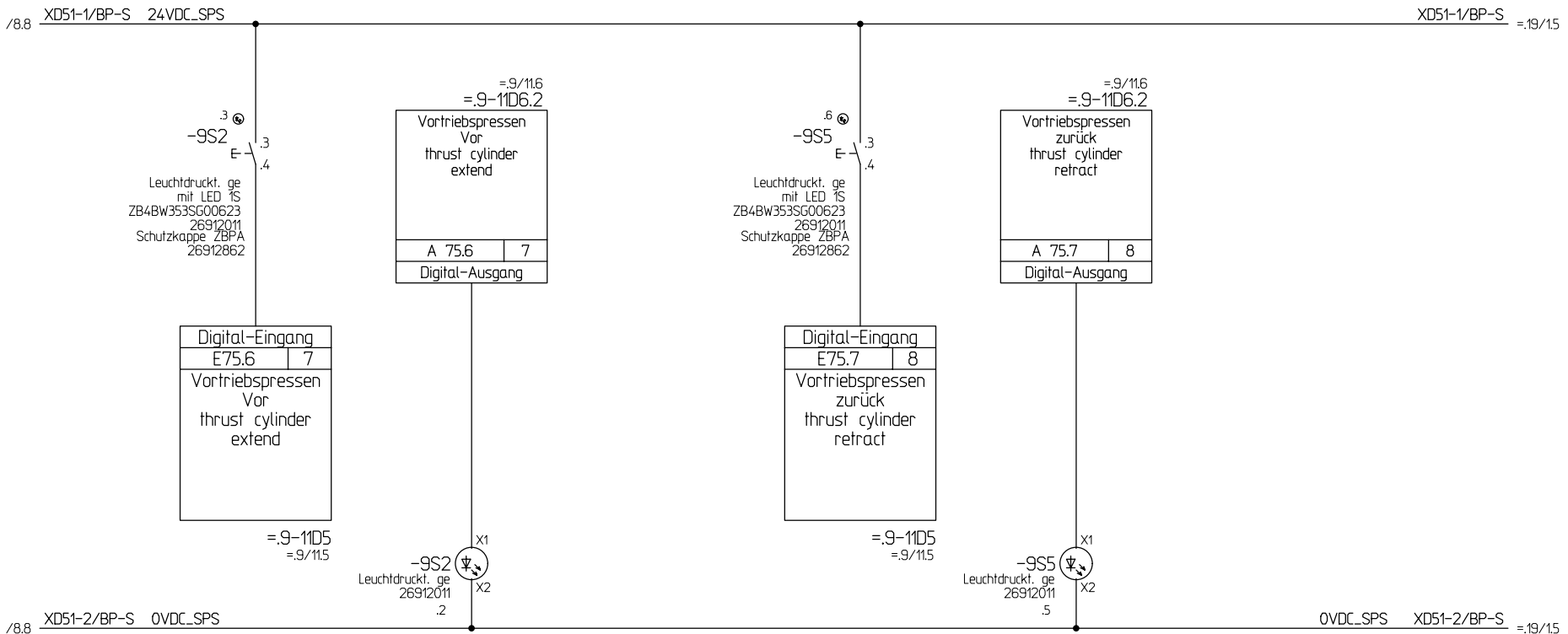

Patent-, Gebrauchsmuster- oder Geschmacksmuster-Eintragung vorbehalten. of a patent, utility model or design.
 ausdrucklich gestattet. Zuwiderhandlungen verpflichten zu Schadenersatz. Alle Rechte fuer den Fall der authorisation is prohibited. Offenders will be held liable for the payment of damages. All rights reserved in the event of the grant
 Weitergabe sowie Vervielfaeltigung dieses Dokuments, Verwertung und Mitteilung seines Inhalts sind verboten, soweit nicht The reproduction, distribution and utilization of this document as well as the communication of its contents to others without express

			CAD! KEINE MANUELLEN AENDERUNGEN ! CAD! DONT CHANGE MANUAL		 Herrenknecht AG Schlehenweg 2 D-77963 Schwanau 2 Tel.: 07824 302-0 Fax.: 07824 3403 Info@Herrenknecht.de	Projekt: M-1642-C =Container		Vortriebspressen Vor/zurück thrust cylinder extend/retract Vortriebspr., Dehner/thrust pr., Ijack		Stueckliste: parts list: 25186184		Fg.-Gruppe: funct.-group: .15		Blatt-Nr.: page-nr.: 9				
			Ausdruck-Datum: printout-date: 14.12.11			Zn.-Nr.: drawn-nr.: 3478-562-002-15		Bedienpult Schacht control panel shaft +BP/CP-S		Datum: date: 26.08.2011		Bearb.: name: Th		letzte Aenderung: last modification: IB-Revision 14.12.11 Th		Blatt-Global: page-global: 103/166		von from 18

Patent-, Gebrauchsmuster- oder
Geschmacksmuster-Eintragung vorbehalten.
of a patent, utility model or design.

ausdrücklich gestattet. Zuwiderhandlungen verpflichten
zu Schadensersatz. Alle Rechte fuer den Fall der
Auhorisation is prohibited. Offenders will be held liable for the
payment of damages. All rights reserved in the event of the grant

Weitergabe sowie Vervielfaeltigung dieses Dokuments, Verwertung
und Mitteilung seines Inhalts sind verboten, soweit nicht
The reproduction, distribution and utilization of this document as
well as the communication of its contents to others without express

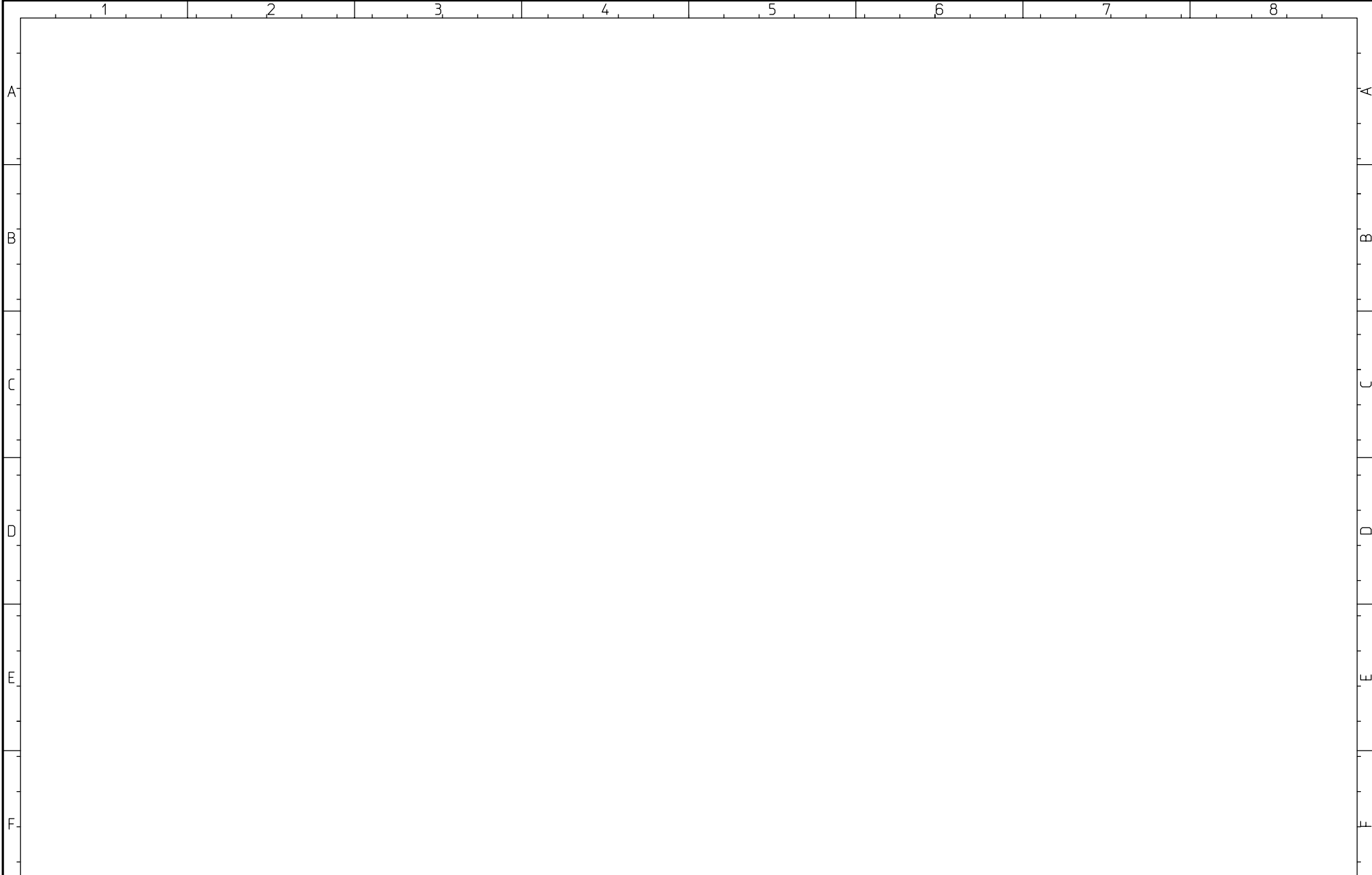

			CAD! KEINE MANUELLEN AENDERUNGEN ! CAD! DONT CHANGE MANUAL	 Herrenknecht AG Schlehenweg 2 D-77963 Schwanau 2 Tel.: 07824 302-0 Fax.: 07824 3403 Info@Herrenknecht.de	Projekt: project: M-1642-C	Reserve reserve	Stueckliste: parts list: 25186184	Fg.-Gruppe: funct.-group: .15	Blatt-Nr.: page-nr.: 10
Index Index	Aenderung-Nr. Change No.:	Datum / Name date / name	Ausdruck-Datum: printout-date: 14.12.11		=Container	Vortriebspr., Dehner/thrust pr., Ijack			Blatt-Global: page-global: 104/166
					Zn.-Nr.: drawn-nr.: 3478-562-002-.15	Datum: date: 26.08.2011	Bearb.: name: Th	letzte Aenderung: last modification: 14.12.11 Th	

Patent-, Gebrauchsmuster- oder Geschmacksmuster-Eintragung vorbehalten. of a patent, utility model or design.
 ausdruecklich gestattet. Zuwendungen verpflichten zu Schadensersatz. Alle Rechte fuer den Fall der Auhonization is prohibited. Offenders will be held liable for the payment of damages. All rights reserved in the event of the grant
 Weitergabe sowie Vervielfaeltigung dieses Dokuments, Verwertung und Mitteilung seines Inhalts sind verboten, soweit nicht The reproduction, distribution and utilization of this document as well as the communication of its contents to others without express

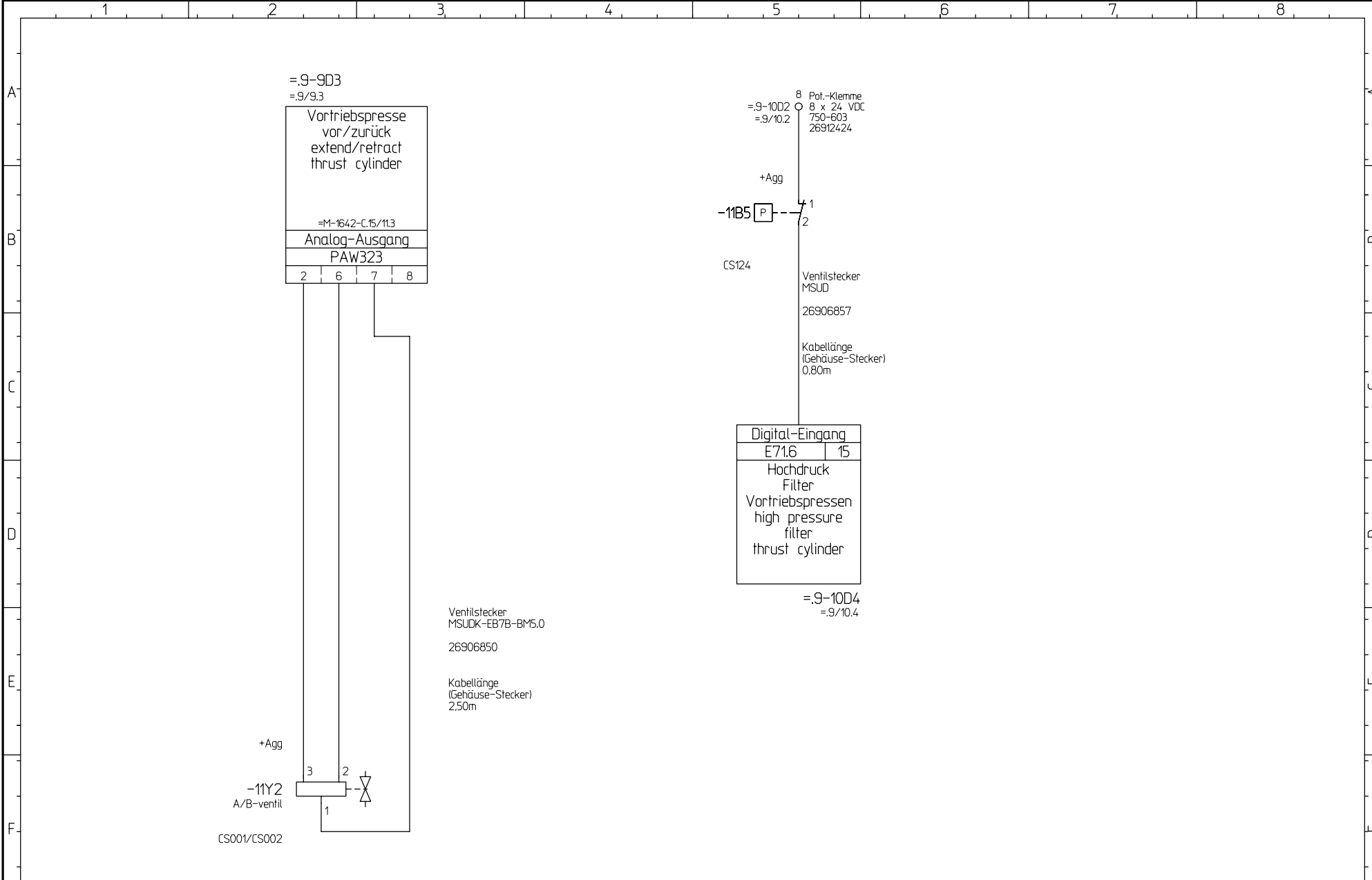

			CAD! KEINE MANUELLEN AENDERUNGEN! CAD! DONT CHANGE MANUAL		 Herrenknecht AG Schleenweg 2 D-77963 Schwanau 2 Tel.: 07824 302-0 Fax.: 07824 3403 Info@Herrenknecht.de	Projekt: M-1642-C =Container		Ventil Vortriebspresse / Hochdruckfilter valve thrust cylinder / high pressure filter Vortriebspr., Dehner/thrust pr., Ijack		Stueckliste: parts list: 25186184		Fg.-Gruppe: funct.-group: .15		Blatt-Nr.: page-nr.: 11				
			Ausdruck-Datum: printout-date: 14.12.11			Zn.-Nr.: drawn-nr.: 3478-562-002-15		Aggregatdose XD40 +AGG_XD40		Datum: date: 26.08.2011		Bearb.: name: Th		letzte Aenderung: last modification: IB-Revision 14.12.11 Th		Blatt-Global: page-global: 105/166		von from 18

Patent-, Gebrauchsmuster- oder Geschmacksmuster-Eintragung vorbehalten. of a patent, utility model or design.
 ausdrucklich gestattet. Zuwiderhandlungen verpflichten zu Schadenersatz. Alle Rechte fuer den Fall der authorization is prohibited. Offenders will be held liable for the payment of damages. All rights reserved in the event of the grant
 Weitergabe sowie Vervielfaeltigung dieses Dokuments, Verwertung und Mitteilung seines Inhalts sind verboten, soweit nicht The reproduction, distribution and utilization of this document as well as the communication of its contents to others without express

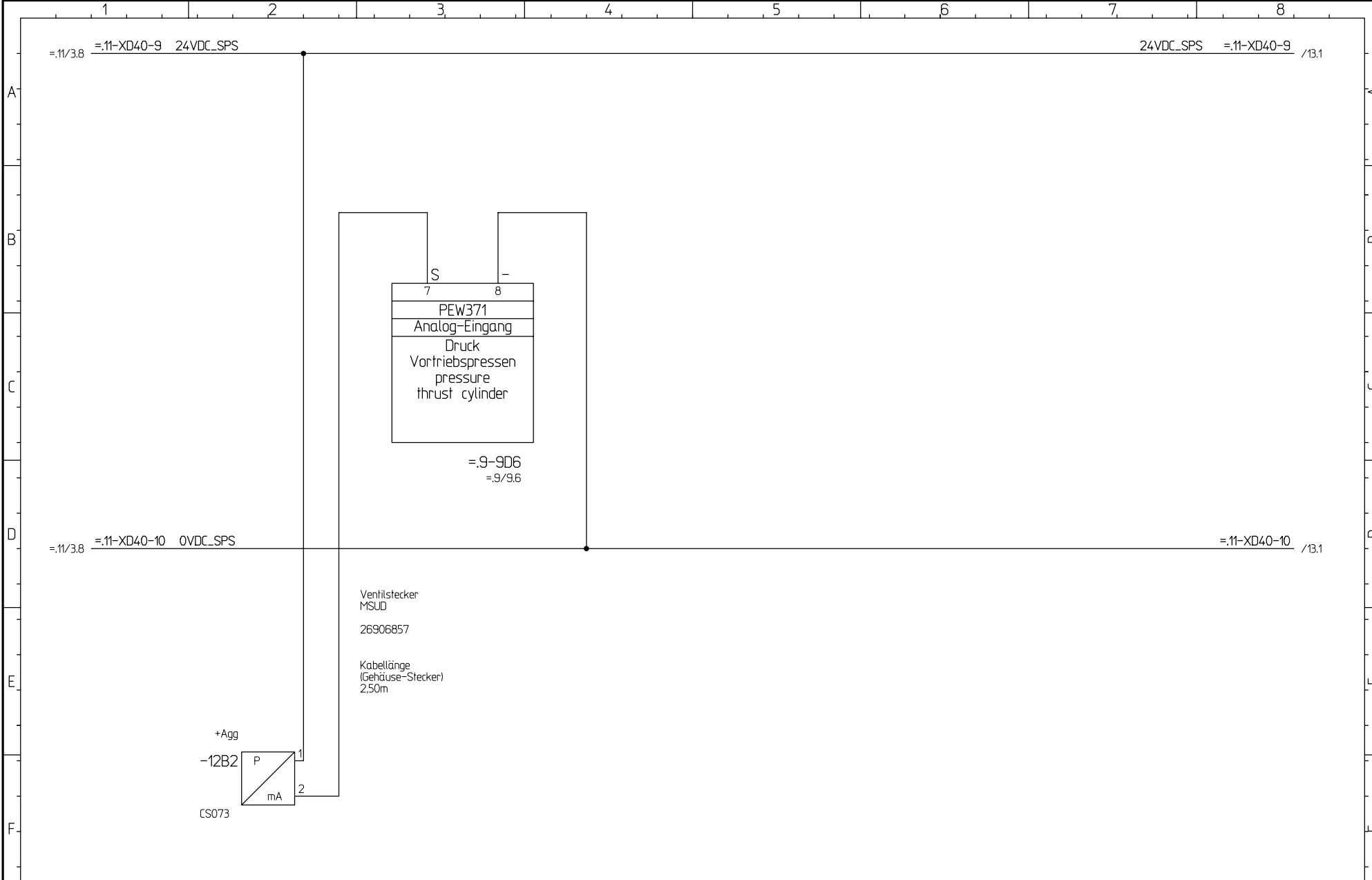

			CAD! KEINE MANUELLEN AENDERUNGEN ! CAD! DONT CHANGE MANUAL		Herrenknecht AG Schlehenweg 2 D-77963 Schwanau 2 Tel.: 07824 302-0 Fax.: 07824 3403 Info@Herrenknecht.de		Projekt: M-1642-C =Container		Druck Vortriebspresen pressure thrust cylinder Vortriebspr., Dehner/thrust pr., ljack		Stueckliste: parts list: 25186184		Fg.-Gruppe: funct.-group: .15		Blatt-Nr.: page-nr.: 12	
			Ausdruck-Datum: printout-date: 14.12.11				Zn.-Nr.: drawn-nr.: 3478-562-002-15		Aggregatedose XD40 +AGG_XD40		Datum: date: 26.08.2011		Bearb.: name: Th		letzte Aenderung: last modification: IB-Revision 14.12.11 Th	
													Blatt-Global: page-global: 106/166		von from 18	

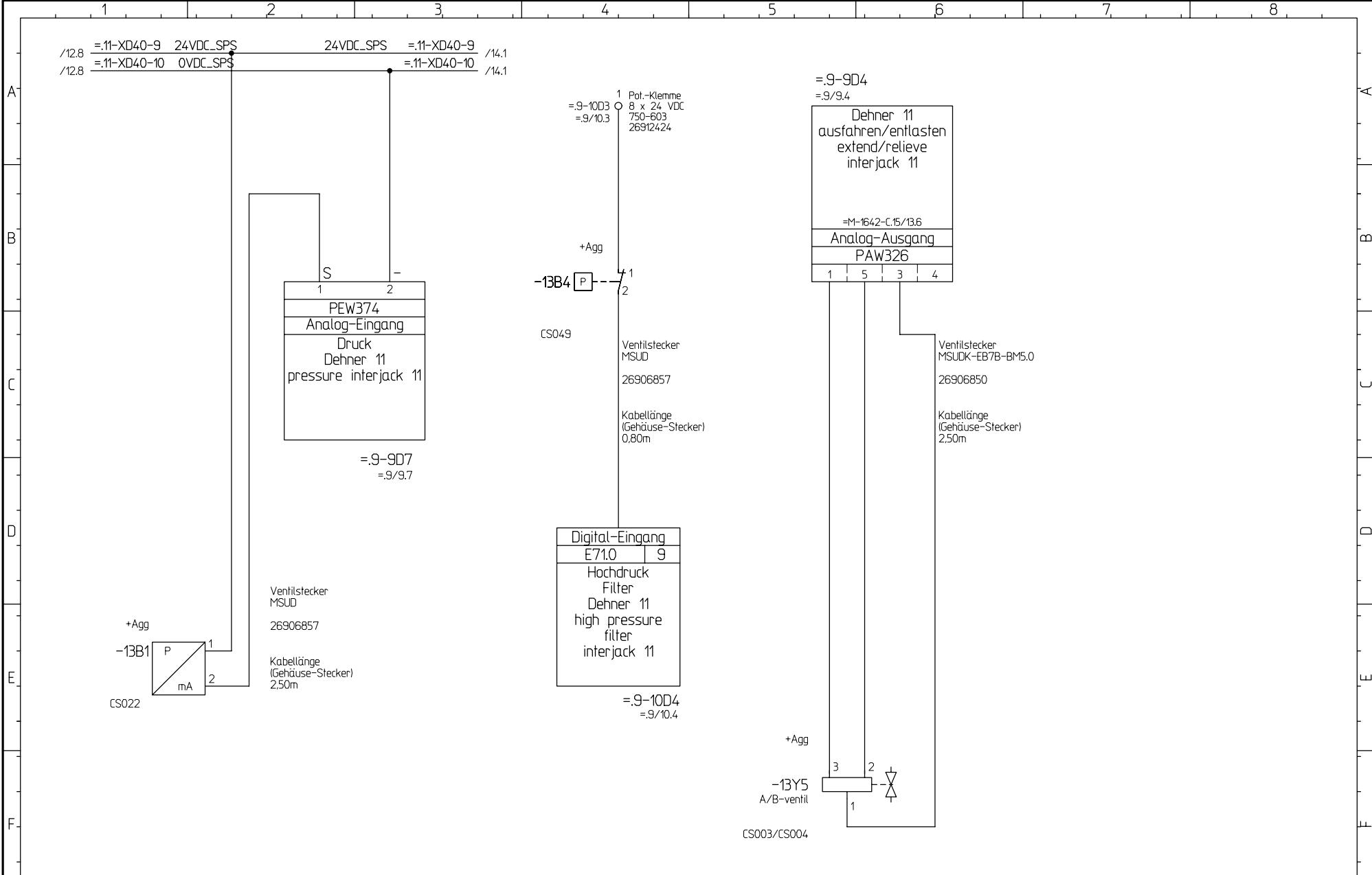

Patent-, Gebrauchsmuster- oder Geschmacksmuster-Eintragung vorbehalten. of a patent, utility model or design.
 ausdrücklich gestattet. Zuwiderhandlungen verpflichten zu Schadensersatz. Alle Rechte fuer den Fall der Auhonzation is prohibited. Offenders will be held liable for the payment of damages. All rights reserved in the event of the grant
 Weitergabe sowie Vervielfaeltigung dieses Dokuments, Verwertung und Mitteilung seines Inhalts sind verboten, soweit nicht The reproduction, distribution and utilization of this document as well as the communication of its contents to others without express

CAD! KEINE MANUELLEN AENDERUNGEN! CAD! DONT CHANGE MANUAL			 Herrenknecht AG Schlehenweg 2 D-77963 Schwanaau 2 Tel.: 07824 302-0 Fax.: 07824 3403 Info@Herrenknecht.de	Projekt: M-1642-C =Container		Dehner 11 interjack 11 Vortriebspr., Dehner/thrust pr., Ijack		Stueckliste: parts list: 25186184		Fg.-Gruppe: funct.-group: .15		Blatt-Nr.: page-nr.: 13					
Ausdruck-Datum: printout-date: 14.12.11				Zn.-Nr.: drawn-nr.: 3478-562-002-15		Aggregatedose XD40 +AGG_XD40		Datum: date: 26.08.2011		Bearb.: name: Th		letzte Aenderung: last modification: IB-Revision 14.12.11 Th		Blatt-Global: page-global: 107/166		von: from 18	
Index Index				Änderung-Nr.: Change No.:			Datum / Name date / name			Blatt-Global: page-global: 107/166			von: from 18				

Patent-, Gebrauchsmuster- oder Geschmacksmuster-Eintragung vorbehalten.
 of a patent, utility model or design.
 ausdrucklich gestattet. Zuwiderhandlungen verpflichten zu Schadensersatz. Alle Rechte fuer den Fall der Auhorisation is prohibited. Offenders will be held liable for the payment of damages. All rights reserved in the event of the grant
 Weitergabe sowie Vervielfaeltigung dieses Dokuments, Verwertung und Mitteilung seines Inhalts sind verboten, soweit nicht The reproduction, distribution and utilization of this document as well as the communication of its contents to others without express

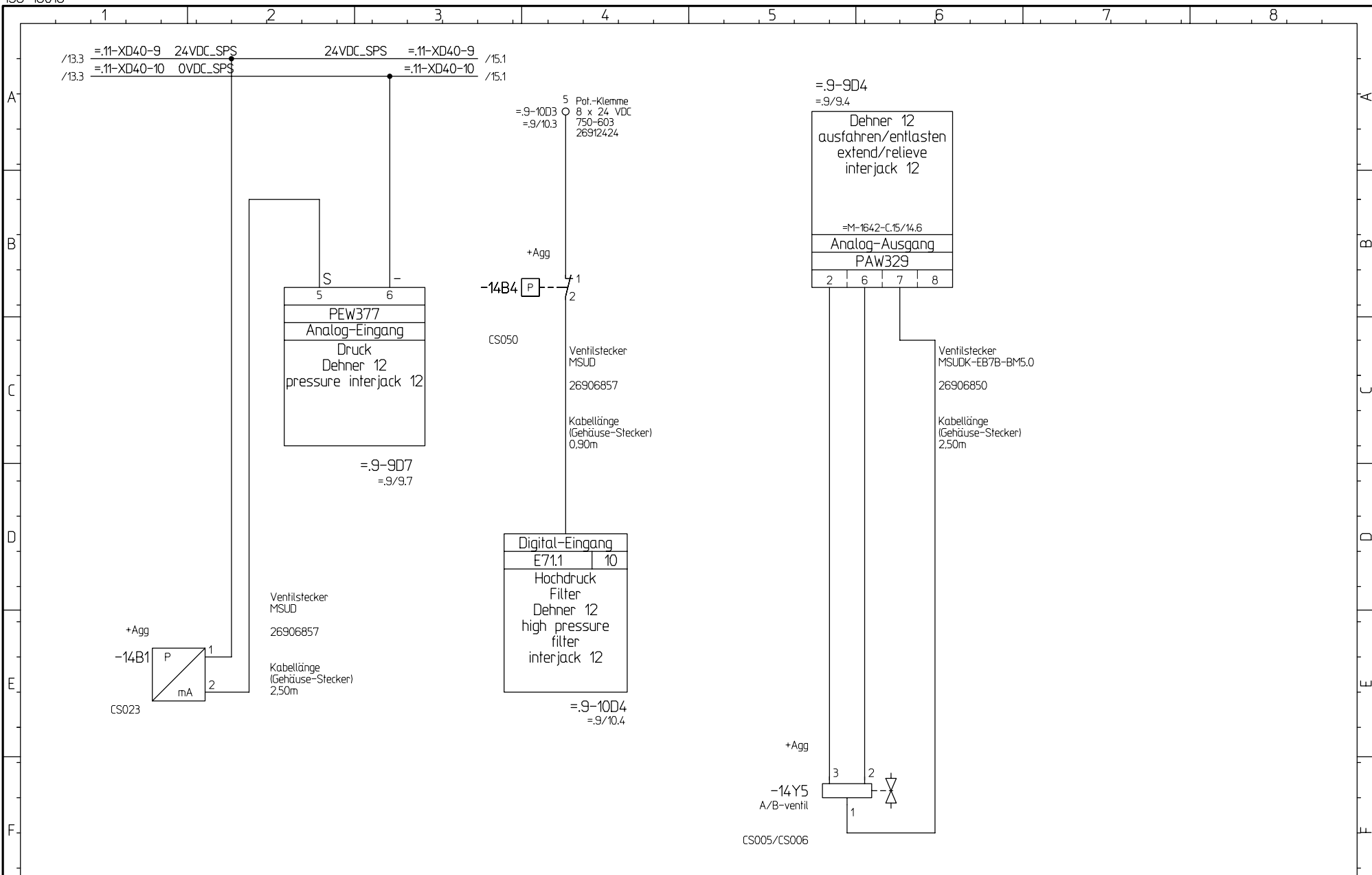



			CAD! KEINE MANUELLEN AENDERUNGEN! CAD! DONT CHANGE MANUAL		Herrenknecht AG Schlehenweg 2 D-77963 Schwanau 2 Tel.: 07824 302-0 Fax: 07824 3403 Info@Herrenknecht.de		Projekt: M-1642-C =Container		Dehner 12 interjack 12 Vortriebspr., Dehner/thrust pr., Ijack		Stueckliste: parts list: 25186184		Fg.-Gruppe: funct.-group: .15		Blatt-Nr.: page-nr.: 14	
			Ausdruck-Datum: printout-date: 14.12.11				Zn.-Nr.: drawn-nr.: 3478-562-002-15		Aggregatdose XD40 +AGG_XD40		Datum: date: 26.08.2011		Bearb.: name: Th		letzte Aenderung: last modification: IB-Revision 14.12.11 Th	
Index Änderung-Nr. Change No.:		Datum / Name date / name														

Patent-, Gebrauchsmuster- oder
 Geschmacksmuster-Eintragung vorbehalten.
 of a patent, utility model or design.

ausdrücklich gestattet. Zuwiderhandlungen verpflichten
 zu Schadensersatz. Alle Rechte fuer den Fall der
 authorisation is prohibited. Offenders will be held liable for the
 payment of damages. All rights reserved in the event of the grant

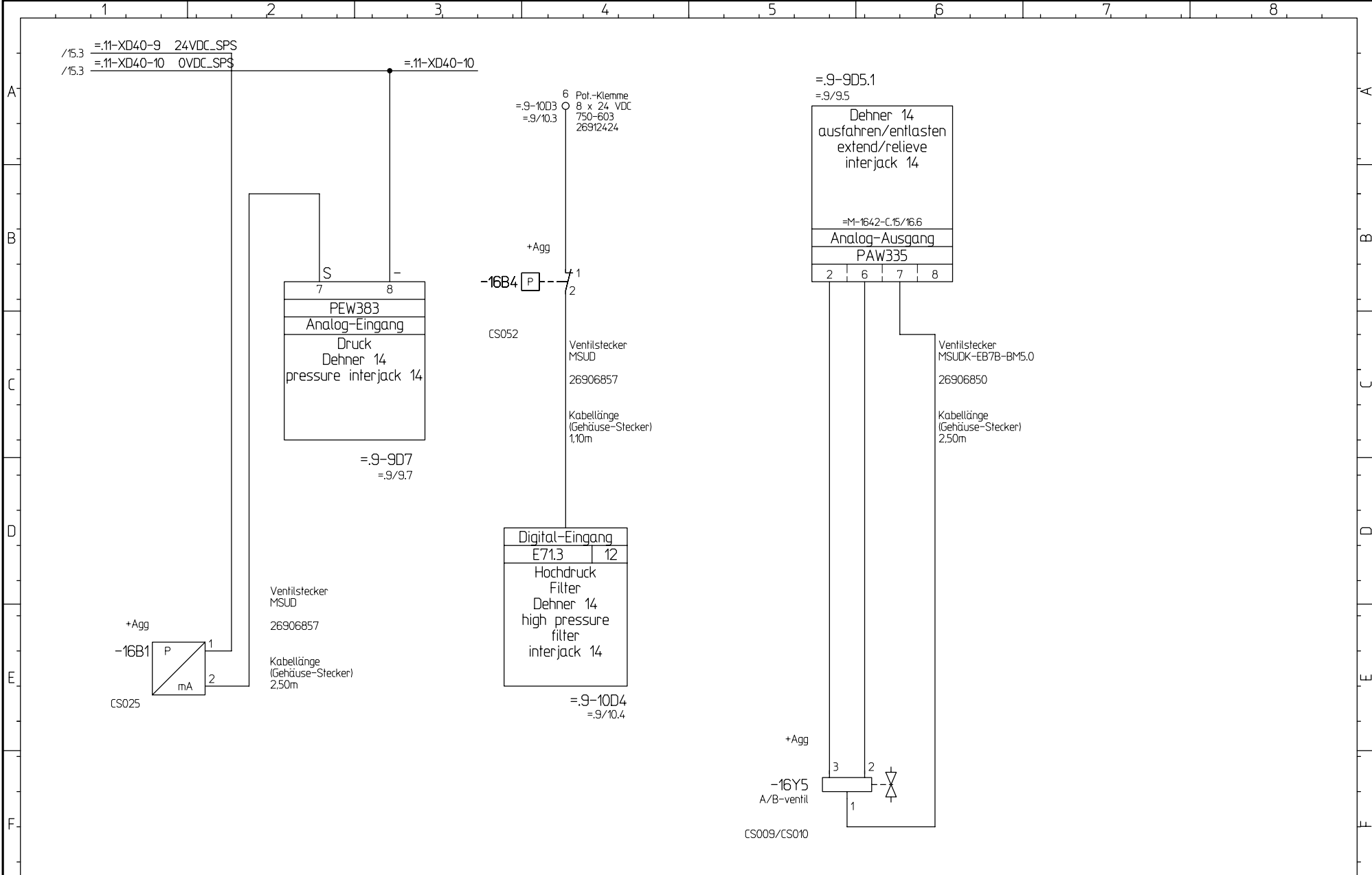
Weitergabe sowie Vervielfaeltigung dieses Dokuments, Verwertung
 und Mitteilung seines Inhalts sind verboten, soweit nicht
 The reproduction, distribution and utilization of this document as
 well as the communication of its contents to others without express



			CAD! KEINE MANUELLEN AENDERUNGEN! CAD! DONT CHANGE MANUAL		Herrenknecht AG Schlehenweg 2 D-77963 Schwanau 2 Tel.: 07824 302-0 Fax.: 07824 3403 Info@Herrenknecht.de		Projekt: project: M-1642-C		Dehner 14 interjack 14		Stueckliste: parts list: 25186184		Fg.-Gruppe: funct.-group: .15		Blatt-Nr.: page-nr.: 16	
			Ausdruck-Datum: printout-date: 14.12.11				=Container		Vortriebspr., Dehner/thrust pr., Ijack		Blatt-Global: page-global: 110/166		von from 18			
Index	Änderung-Nr. Change No.:	Datum / Name date / name				Zn.-Nr. drawn-nr.:	3478-562-002-15		Aggregatdose XD40 +AGG_XD40		Datum: date:	26.08.2011		Bearb. name:	Th	
										letzte Änderung: last modification: 14.12.11		Th				

Patent-, Gebrauchsmuster- oder Geschmacksmuster-Eintragung vorbehalten.
 of a patent, utility model or design.
 ausdrucklich gestattet. Zuwiderhandlungen verpflichten zu Schadenersatz. Alle Rechte fuer den Fall der Auhorisation ist prohibited. Offenders will be held liable for the payment of damages. All rights reserved in the event of the grant
 Weitergabe sowie Vervielfaeltigung dieses Dokuments, Verwertung und Mitteilung seines Inhalts sind verboten, soweit nicht The reproduction, distribution and utilization of this document as well as the communication of its contents to others without express

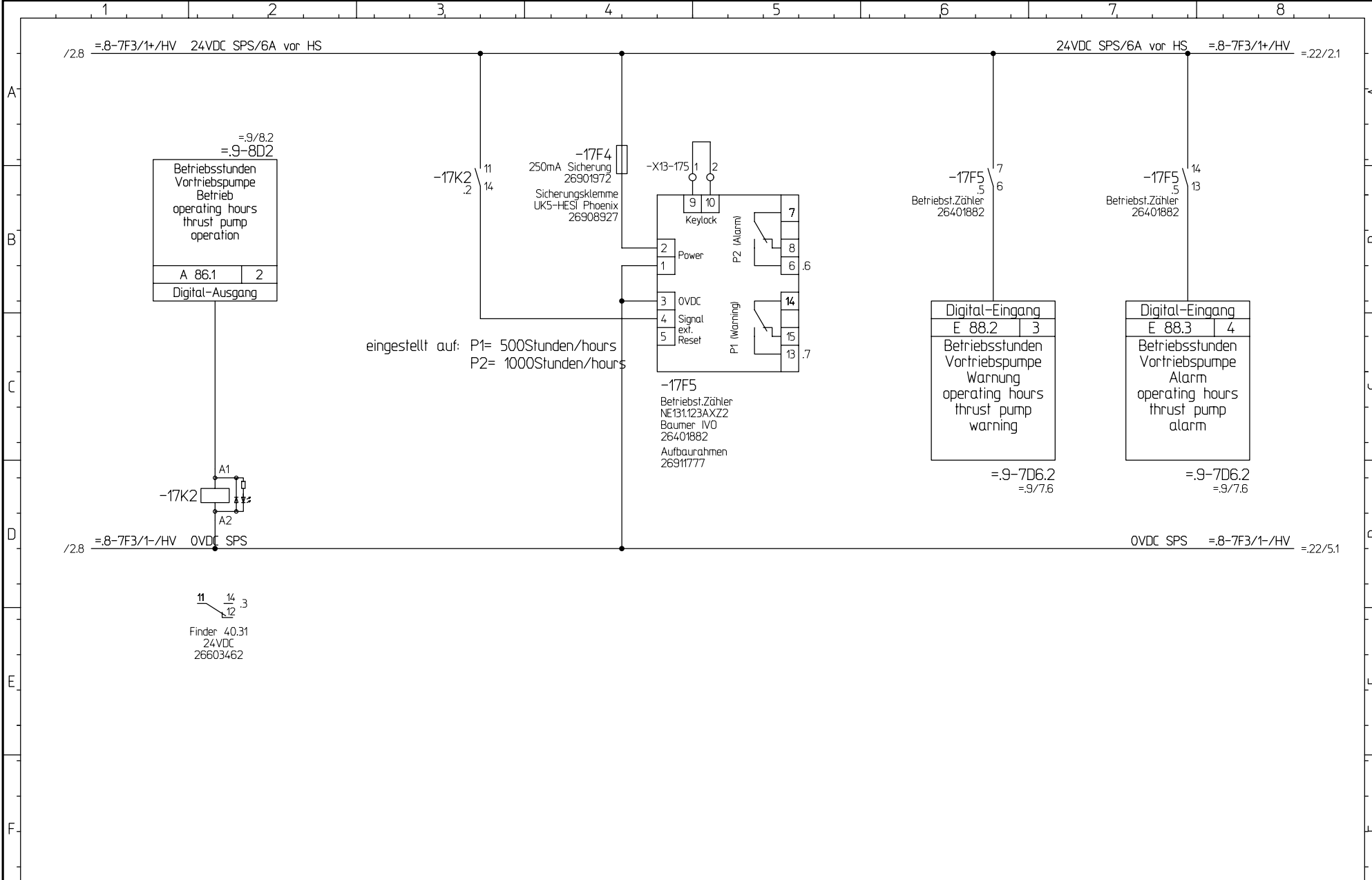



CAD! KEINE MANUELLEN AENDERUNGEN ! CAD! DONT CHANGE MANUAL Ausdruck-Datum: printout-date: 14.12.11			 Herrenknecht AG Schlehenweg 2 D-77963 Schwanaau 2 Tel.: 07824 302-0 Fax.: 07824 3403 Info@Herrenknecht.de	Projekt: M-1642-C =Container		Betriebsstunden Vortriebspumpe operating hours thrust pump Vortriebspr., Dehner/thrust pr., Ijack		Stueckliste: parts list: 25186184 Fg.-Gruppe: funct.-group: .15 Blatt-Nr.: page-nr.: 17	
Index Änderung-Nr. Datum / Name Index Change No.: date / name				Zn.-Nr.: drawn-nr.: 3478-562-002-15	Hauptverteilung main distribution board +HV/MDB		Datum: date: 26.08.2011	Bearb.: name: Th	letzte Aenderung: last modification: IB-Revision 14.12.11 Th

Patent-, Gebrauchsmuster- oder Geschmacksmuster-Eintragung vorbehalten.
 of a patent, utility model or design.

ausdrücklich gestattet. Zuwiderhandlungen verpflichten zu Schadensersatz. Alle Rechte fuer den Fall der Autorisation ist prohibited. Offenders will be held liable for the payment of damages. All rights reserved in the event of the grant

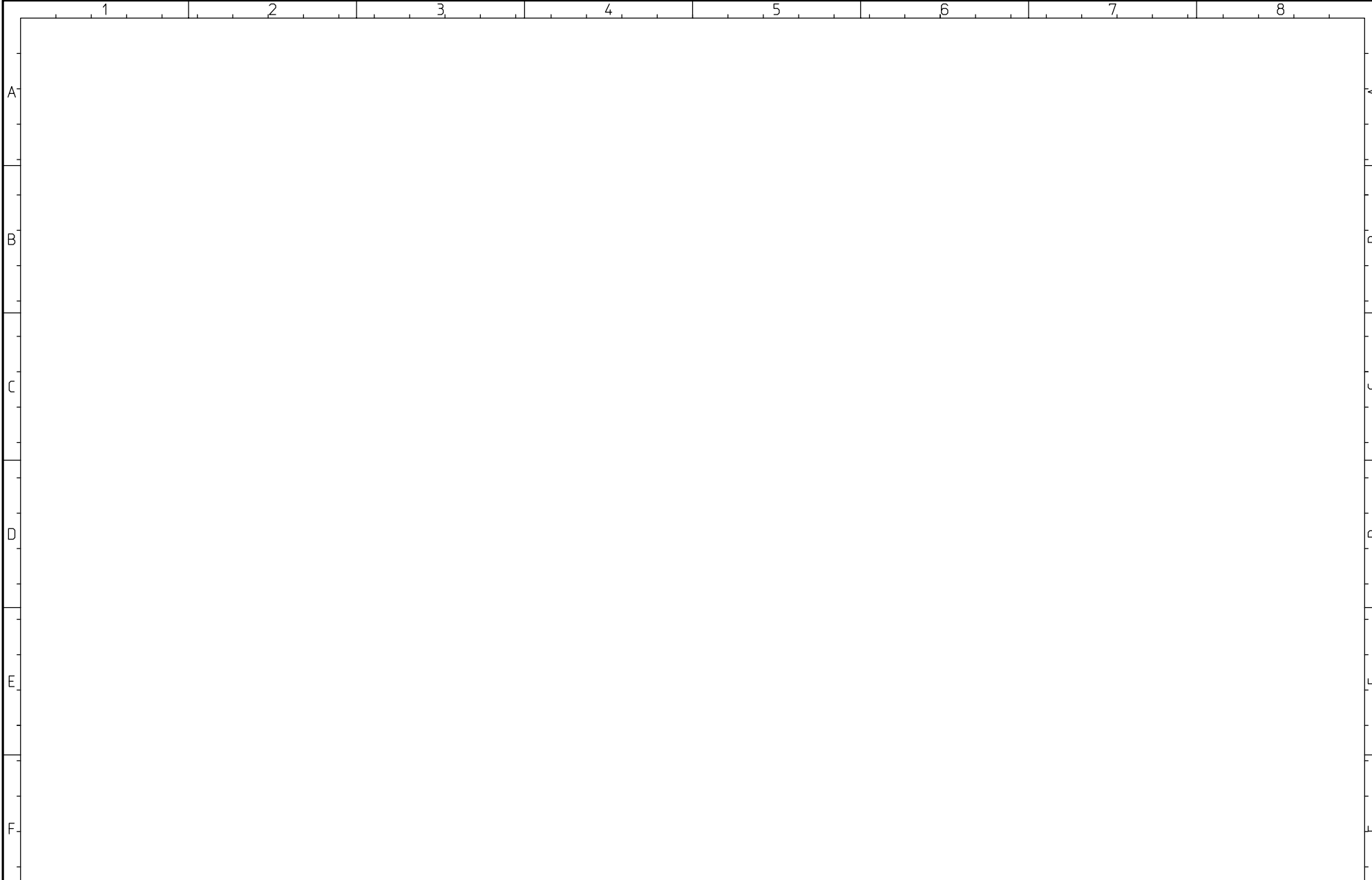
Weitergabe sowie Vervielfaeltigung dieses Dokuments, Verwertung und Mitteilung seines Inhalts sind verboten, soweit nicht The reproduction, distribution and utilization of this document as well as the communication of its contents to others without express



			CAD! KEINE MANUELLEN AENDERUNGEN ! CAD! DONT CHANGE MANUAL	 Herrenknecht AG Schlehenweg 2 D-77963 Schwanau 2 Tel.: 07824 302-0 Fax.: 07824 3403 Info@Herrenknecht.de	Projekt: project: M-1642-C	Reserve reserve	Stueckliste: parts list: 25186184	Fg.-Gruppe: funct.-group: .15	Blatt-Nr.: page-nr.: 18
Index Index	Aenderung-Nr. Change No.:	Datum / Name date / name	Ausdruck-Datum: printout-date: 14.12.11		=Container	Vortriebspr., Dehner/thrust pr., Ijack			Blatt-Global: page-global: 112/166
					Zn.-Nr.: drawn-nr.: 3478-562-002-15	Datum: date: 26.08.2011	Bearb.: name: Th	letzte Aenderung: last modification: 14.12.11 Th	

Patent-, Gebrauchsmuster- oder Geschmacksmuster-Eintragung vorbehalten.
 of a patent, utility model or design.
 ausdrucklich gestattet. Zuwiderhandlungen verpflichten zu Schadenersatz. Alle Rechte fuer den Fall der authorisation is prohibited. Offenders will be held liable for the payment of damages. All rights reserved in the event of the grant
 Weitergabe sowie Vervielfaeltigung dieses Dokuments, Verwertung und Mitteilung seines Inhalts sind verboten, soweit nicht The reproduction, distribution and utilization of this document as well as the communication of its contents to others without express

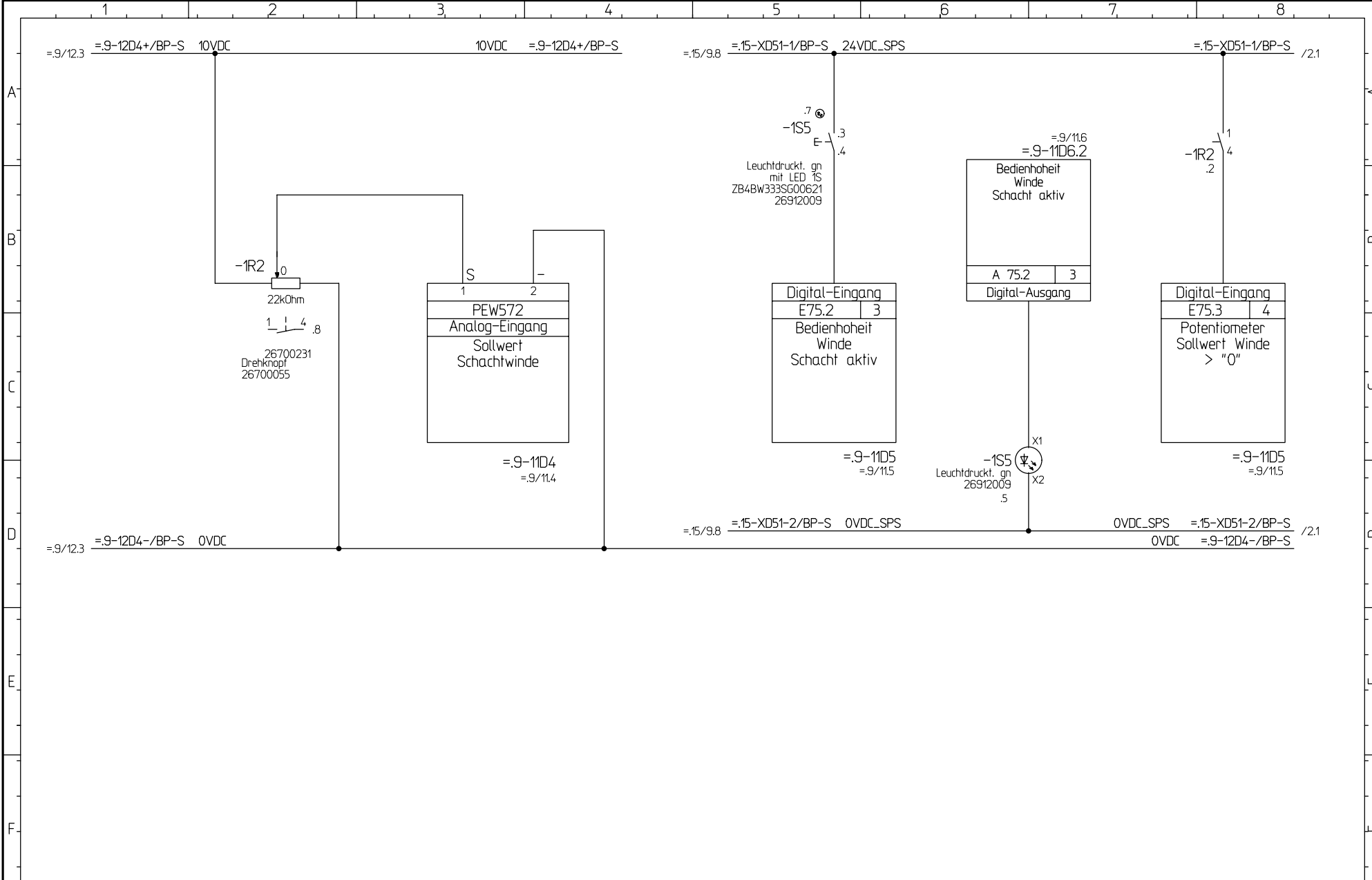

			CAD! KEINE MANUELLEN AENDERUNGEN! CAD! DONT CHANGE MANUAL		 Herrenknecht AG Schlehenweg 2 D-77963 Schwanau 2 Tel.: 07824 302-0 Fax.: 07824 3403 Info@Herrenknecht.de	Projekt: M-1642-C =Container		Bedienhoheit/Sollwert Schachtwinde Maschinenwinde / machine winch		Stueckliste: parts list: 25186184		Fg.-Gruppe: funct.-group: .19		Blatt-Nr.: page-nr.: 1				
			Ausdruck-Datum: printout-date: 14.12.11			Zn.-Nr.: drawn-nr.: 3478-562-002-.19		Bedienpult Schacht control panel shaft +BP/CP-S		Datum: date: 26.08.2011		Bearb.: name: Th		letzte Aenderung: last modification: IB-Revision 14.12.11 Th		Blatt-Global: page-global: 113/166		von from 6

Patent-, Gebrauchsmuster- oder Geschmacksmuster-Eintragung vorbehalten.
 of a patent, utility model or design.
 ausdrucklich gestattet. Zuwiderhandlungen verpflichten zu Schadenersatz. Alle Rechte fuer den Fall der Auhonanzion ist prohibited. Offenders will be held liable for the payment of damages. All rights reserved in the event of the grant
 Weitergabe sowie Vervielfaelligung dieses Dokuments, Verwertung und Mitteilung seines Inhalts sind verboten, soweit nicht The reproduction, distribution and utilization of this document as well as the communication of its contents to others without express

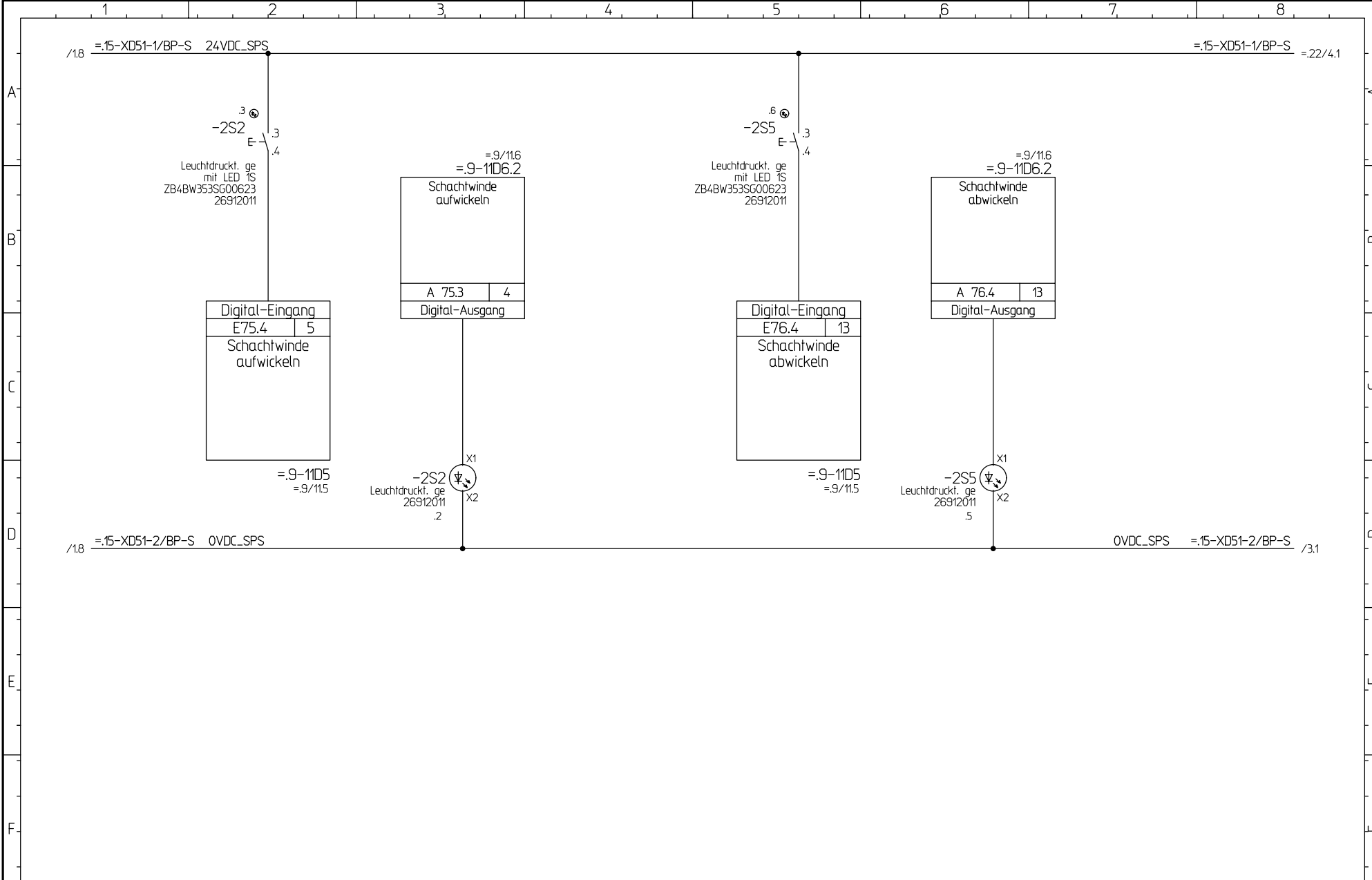

			CAD! KEINE MANUELLEN AENDERUNGEN! CAD! DONT CHANGE MANUAL		 Herrenknecht AG Schlehenweg 2 D-77963 Schwanau 2 Tel.: 07824 302-0 Fax.: 07824 3403 Info@Herrenknecht.de	Projekt: M-1642-C =Container		Schachtwinde auf-/abwickeln shaft winch wind up/down Maschinenwinde / machine winch		Stueckliste: 25186184 parts list:		Fg.-Gruppe: .19 funct.-group:		Blatt-Nr.: 2 page-nr.:				
			Ausdruck-Datum: 14.12.11 printout-date:			Zn.-Nr.: 3478-562-002-.19 drawn-nr.:		Bedienpult Schacht control panel shaft +BP/CP-S		Datum: 26.08.2011 date:		Bearb.: Th name:		letzte Aenderung: 14.12.11 Th last modification:		Blatt-Global: 114/166 page-global:		von from 6

Patent-, Gebrauchsmuster- oder Geschmacksmuster-Eintragung vorbehalten. of a patent, utility model or design.
 ausdrucklich gestattet. Zuwiderhandlungen verpflichten zu Schadenersatz. Alle Rechte fuer den Fall der authorisation is prohibited. Offenders will be held liable for the payment of damages. All rights reserved in the event of the grant
 Weitergabe sowie Vervielfaeltigung dieses Dokuments, Verwertung und Mitteilung seines Inhalts sind verboten, soweit nicht The reproduction, distribution and utilization of this document as well as the communication of its contents to others without express

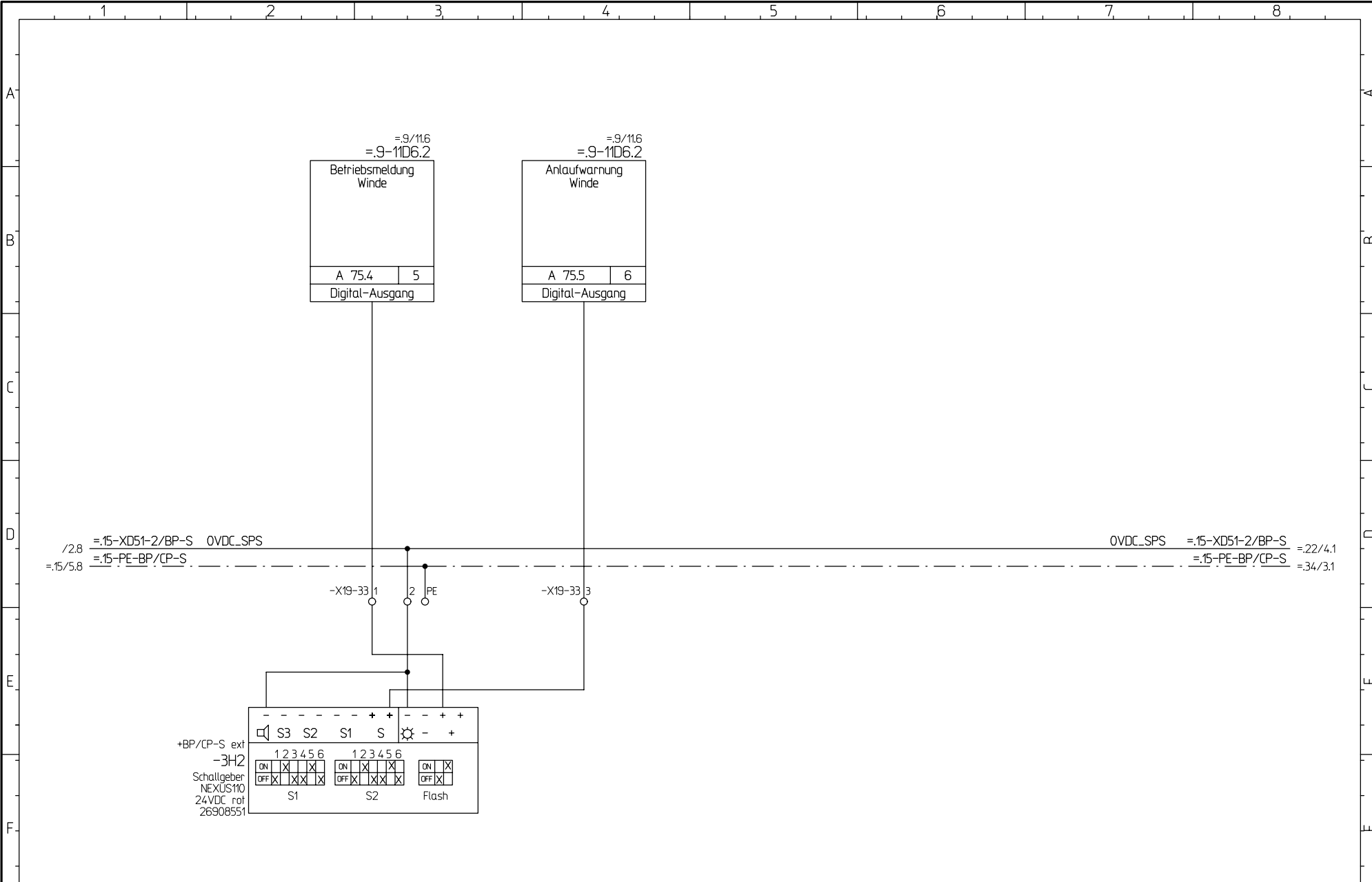



CAD! KEINE MANUELLEN AENDERUNGEN! CAD! DONT CHANGE MANUAL			 Herrenknecht AG Schleenweg 2 D-77963 Schwanau 2 Tel.: 07824 302-0 Fax.: 07824 3403 Info@Herrenknecht.de	Projekt: M-1642-C =Container		Betriebsmeldung Winde Maschinenwinde / machine winch		Stueckliste: parts list: 25186184	Fg.-Gruppe: funct.-group: .19	Blatt-Nr.: page-nr.: 3	
Index Index	Änderung-Nr. Change No.:	Datum / Name date / name 14.12.11		Ausdruck-Datum: printout-date: 14.12.11		Zn.-Nr.: drawn-nr.: 3478-562-002-.19	Bedienpult Schacht control panel shaft +BP/CP-S	Datum: date: 26.08.2011	Bearb.: name: Th	letzte Aenderung: last modification: IB-Revision 14.12.11 Th	Blatt-Global: page-global: 115/166

Patent-, Gebrauchsmuster- oder Geschmacksmuster-Eintragung vorbehalten.
 of a patent, utility model or design.

ausdrücklich gestattet. Zuwiderhandlungen verpflichten zu Schadensersatz. Alle Rechte fuer den Fall der Autorisation ist prohibited. Offenders will be held liable for the payment of damages. All rights reserved in the event of the grant

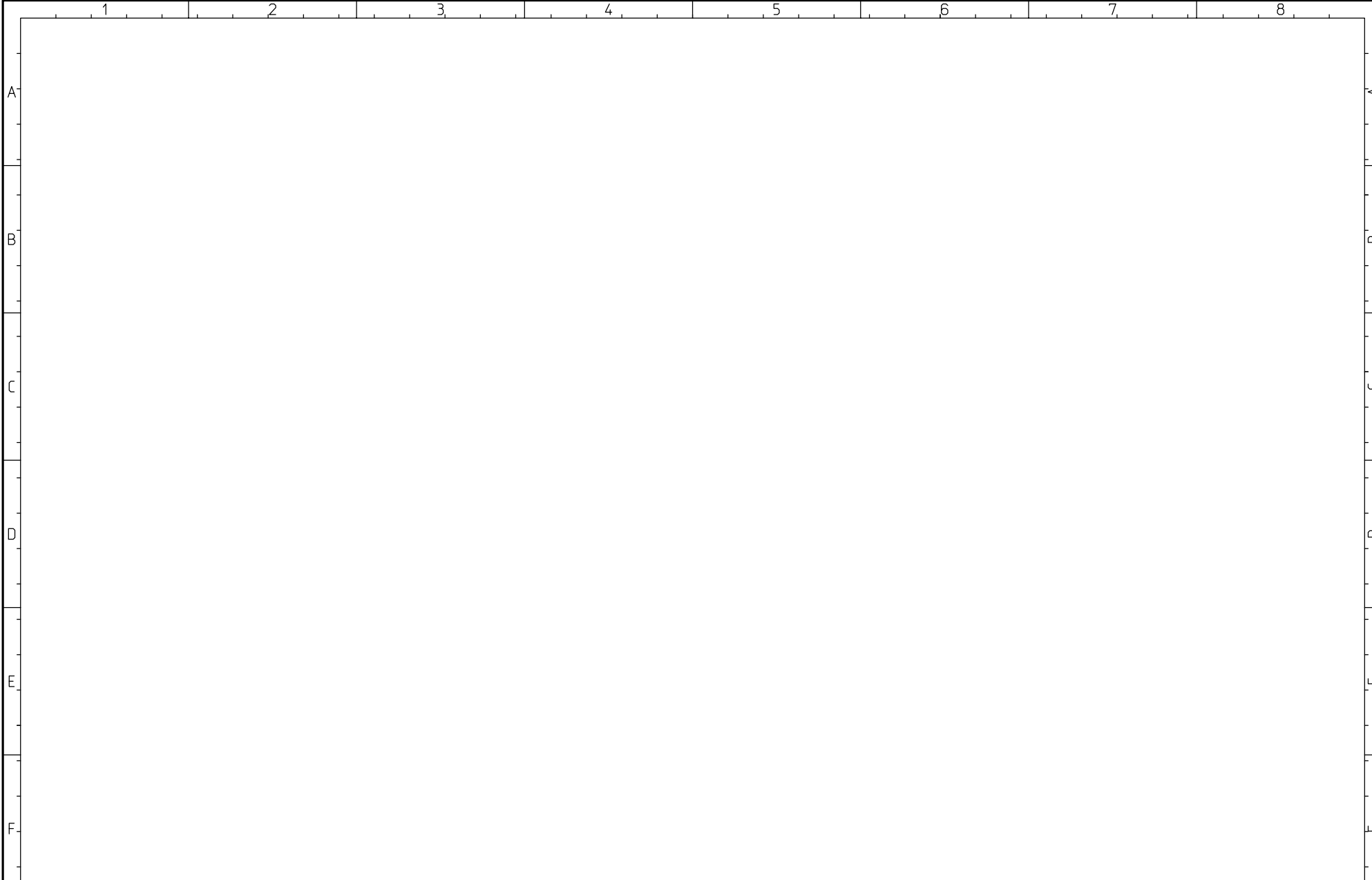
Weitergabe sowie Vervielfaeltigung dieses Dokuments, Verwertung und Mitteilung seines Inhalts sind verboten, soweit nicht The reproduction, distribution and utilization of this document as well as the communication of its contents to others without express



			CAD! KEINE MANUELLEN AENDERUNGEN ! CAD! DONT CHANGE MANUAL	 Herrenknecht AG Schlehenweg 2 D-77963 Schwanau 2 Tel.: 07824 302-0 Fax.: 07824 3403 Info@Herrenknecht.de	Projekt: project: M-1642-C	Reserve reserve	Stueckliste: parts list: 25186184	Fg.-Gruppe: funct.-group: .19	Blatt-Nr.: page-nr.: 4
Index Index	Aenderung-Nr. Change No.:	Datum / Name date / name	Ausdruck-Datum: printout-date: 14.12.11		=Container	Maschinenwinde / machine winch		Blatt-Global: page-global: 116/166	von from
					Zn.-Nr.: drawn-nr.: 3478-562-002-.19	Datum: date: 26.08.2011	Bearb.: name: Th	letzte Aenderung: last modification: 14.12.11 Th	

Patent-, Gebrauchsmuster- oder Geschmacksmuster-Eintragung vorbehalten.
 of a patent, utility model or design.
 ausdrucklich gestattet. Zuwiderhandlungen verpflichten zu Schadensersatz. Alle Rechte fuer den Fall der authorisation is prohibited. Offenders will be held liable for the payment of damages. All rights reserved in the event of the grant
 Weitergabe sowie Vervielfaeltigung dieses Dokuments, Verwertung und Mitteilung seines Inhalts sind verboten, soweit nicht The reproduction, distribution and utilization of this document as well as the communication of its contents to others without express

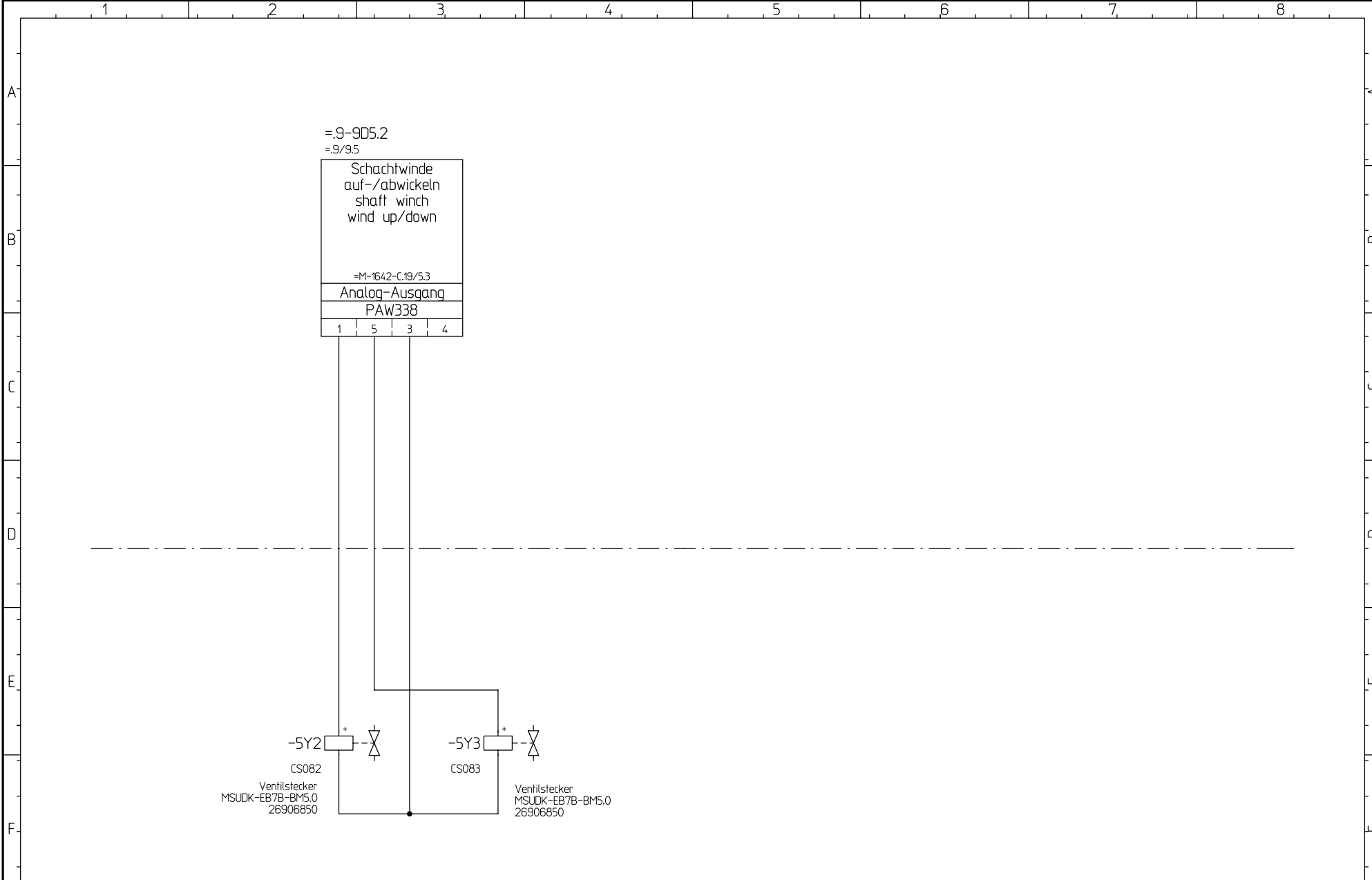



			CAD! KEINE MANUELLEN AENDERUNGEN! CAD! DONT CHANGE MANUAL		Herrenknecht AG Schlehenweg 2 D-77963 Schwanau 2 Tel.: 07824 302-0 Fax.: 07824 3403 Info@Herrenknecht.de		Projekt: M-1642-C =Container		Schachtwinde auf-/abwickeln shaft winch wind up/down Maschinenwinde / machine winch		Stueckliste: parts list: 25186184		Fg.-Gruppe: funct.-group: .19		Blatt-Nr.: page-nr.: 5	
			Ausdruck-Datum: printout-date: 14.12.11				Zn.-Nr.: drawn-nr.: 3478-562-002-.19		Aggregatedose XD40 +AGG_XD40		Datum: date: 26.08.2011		Bearb.: name: Th		letzte Aenderung: last modification: IB-Revision 14.12.11 Th	
Index Index			Aenderung-Nr.: Change No.:												Blatt-Global: page-global: 117/166	

Patent-, Gebrauchsmuster- oder
Geschmacksmuster-Eintragung vorbehalten.
of a patent, utility model or design.

ausdrücklich gestattet. Zuwiderhandlungen verpflichten
zu Schadensersatz. Alle Rechte fuer den Fall der
Auhorisation is prohibited. Offenders will be held liable for the
payment of damages. All rights reserved in the event of the grant

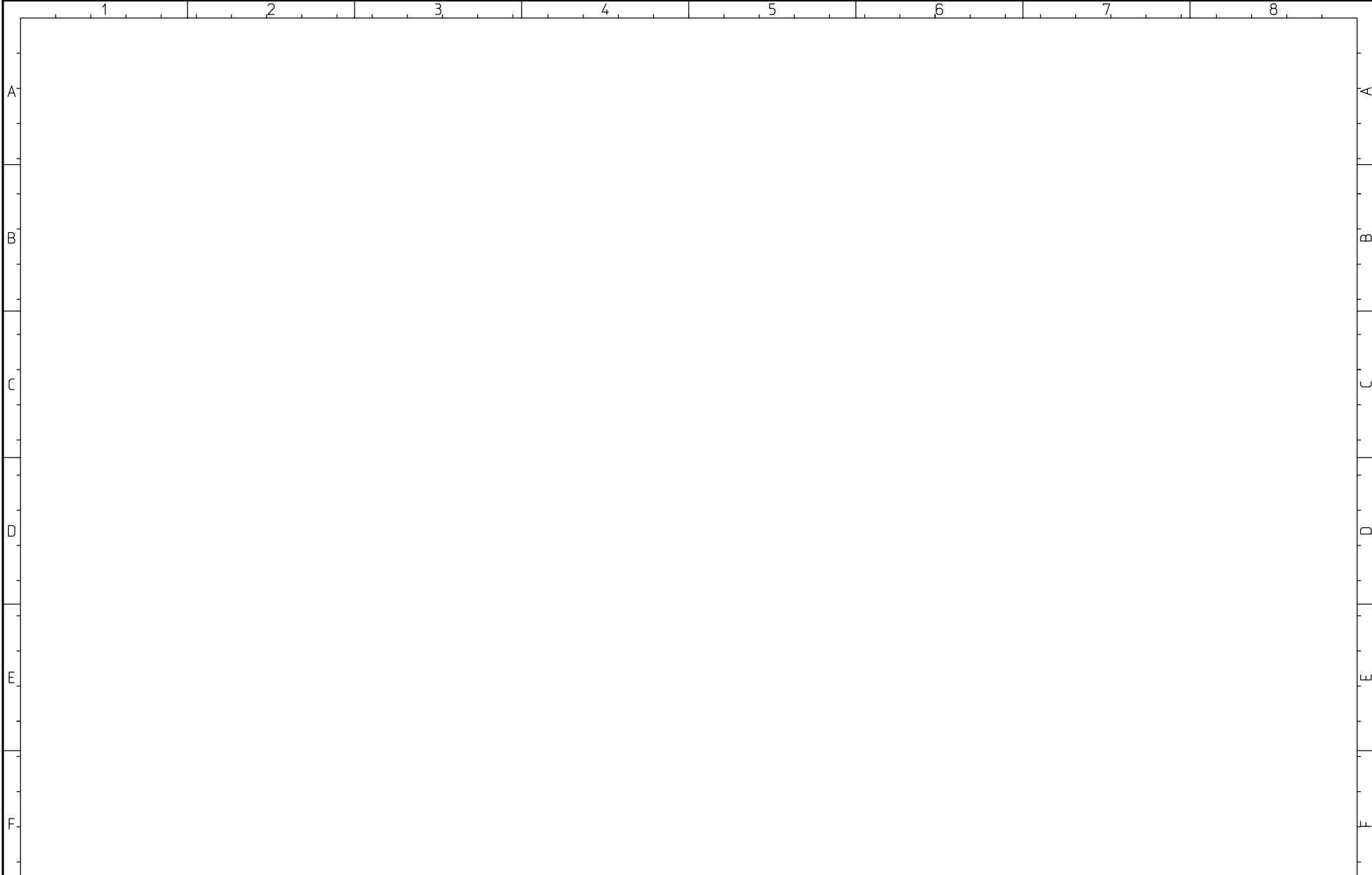
Weitergabe sowie Vervielfaeltigung dieses Dokuments, Verwertung
und Mitteilung seines Inhalts sind verboten, soweit nicht
The reproduction, distribution and utilization of this document as
well as the communication of its contents to others without express



			CAD! KEINE MANUELLEN AENDERUNGEN ! CAD! DONT CHANGE MANUAL	 Herrenknecht AG Schlehenweg 2 D-77963 Schwanau 2 Tel.: 07824 302-0 Fax.: 07824 3403 Info@Herrenknecht.de	Projekt: project: M-1642-C	Reserve reserve	Stueckliste: parts list: 25186184	Fg.-Gruppe: funct.-group: .19	Blatt-Nr.: page-nr.: 6
Index Index	Aenderung-Nr. Change No.:	Datum / Name date / name	Ausdruck-Datum: printout-date: 14.12.11		=Container	Maschinenwinde / machine winch			Blatt-Global: page-global: 118/166
					Zn.-Nr.: drawn-nr.: 3478-562-002-.19	Datum: date: 26.08.2011	Bearb.: name: Th	letzte Aenderung: last modification: 14.12.11 Th	

Patent-, Gebrauchsmuster- oder
 Geschmacksmuster-Eintragung vorbehalten.
 of a patent, utility model or design.

ausdrücklich gestattet. Zuwiderhandlungen verpflichten
 zu Schadensersatz. Alle Rechte fuer den Fall der
 Auhonisation is prohibited. Offenders will be held liable for the
 payment of damages. All rights reserved in the event of the grant

Weitergabe sowie Vervielfaeltigung dieses Dokuments, Verwertung
 und Mitteilung seines Inhalts sind verboten, soweit nicht
 The reproduction, distribution and utilization of this document as
 well as the communication of its contents to others without express

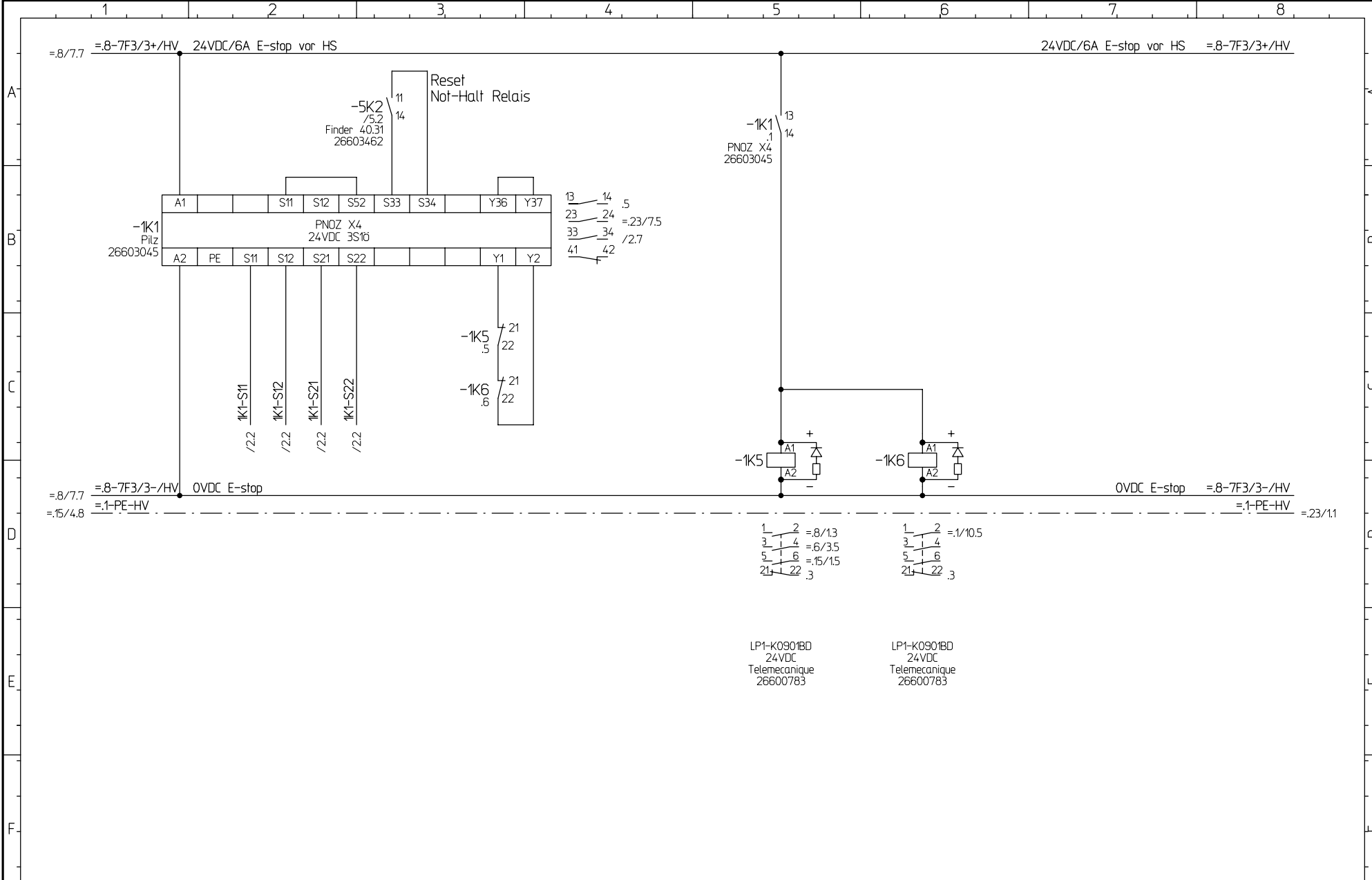

			CAD! KEINE MANUELLEN AENDERUNGEN! CAD! DONT CHANGE MANUAL		Herrenknecht AG Schlehenweg 2 D-77963 Schwana 2 Tel.: 07824 302-0 Fax.: 07824 3403 Info@Herrenknecht.de		Projekt: M-1642-C =Container		Not-Halt Emergency-Stop / Not-Aus		Stueckliste: parts list: 25186184		Fg.-Gruppe: funct.-group: .22		Blatt-Nr.: page-nr.: 1	
			Ausdruck-Datum: printout-date: 14.12.11				Zn.-Nr.: drawn-nr.: 3478-562-002-.22		Hauptverteilung main distribution board +HV/MDB		Datum: date: 26.08.2011		Bearb.: name: Th		letzte Aenderung: last modification: IB-Revision 14.12.11 Th	
Index Index			Aenderung-Nr. Change No.:		Datum / Name date / name								Blatt-Global: page-global: 119/166		von from 8	

Patent-, Gebrauchsmuster- oder
Geschmacksmuster-Eintragung vorbehalten.
of a patent, utility model or design.

ausdrücklich gestattet. Zuwiderhandlungen verpflichten
zu Schadensersatz. Alle Rechte fuer den Fall der
Auhorisation is prohibited. Offenders will be held liable for the
payment of damages. All rights reserved in the event of the grant

Weitergabe sowie Vervielfaeltigung dieses Dokuments, Verwertung
und Mitteilung seines Inhalts sind verboten, soweit nicht
The reproduction, distribution and utilization of this document as
well as the communication of its contents to others without express

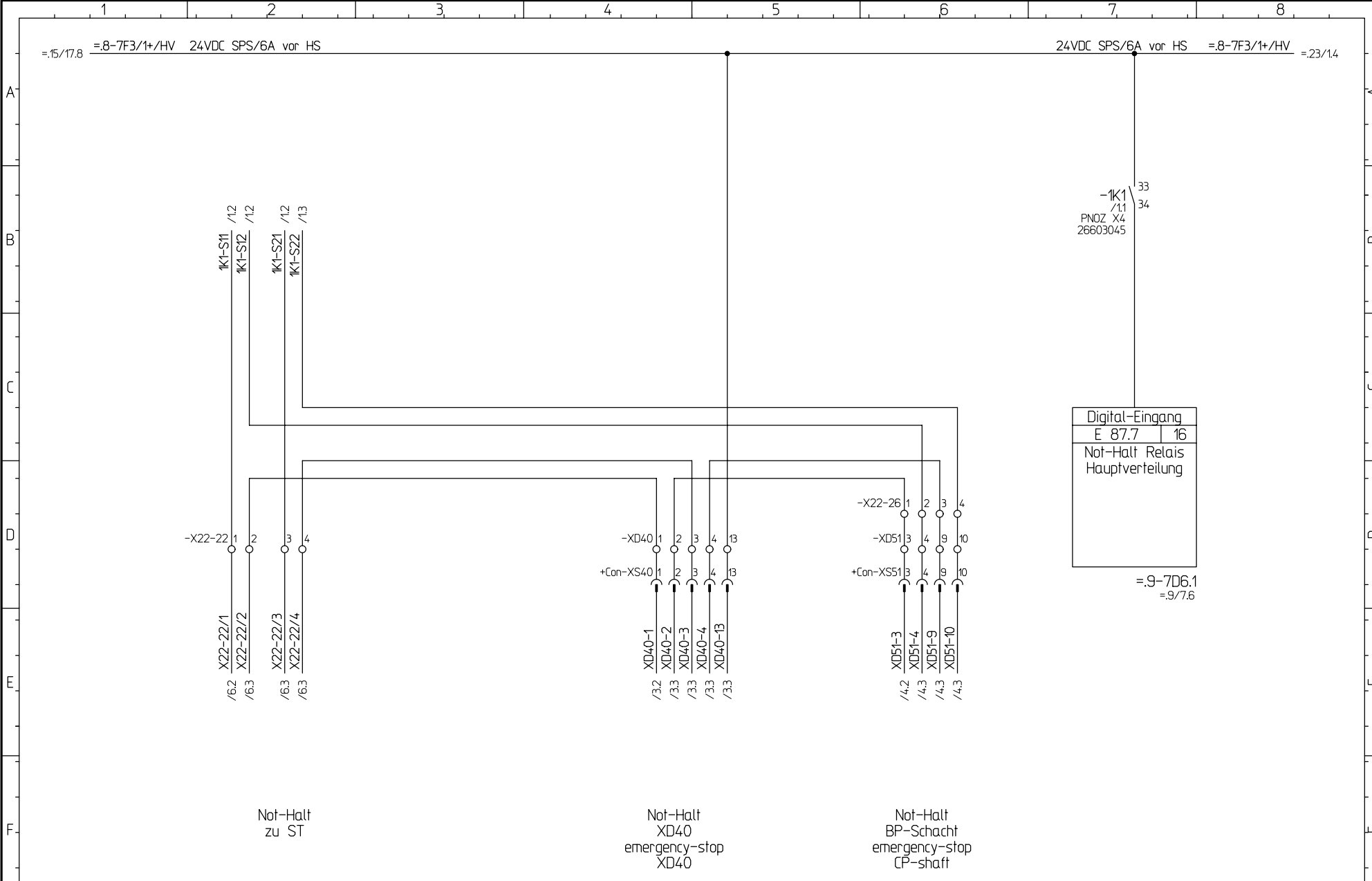

Digital-Eingang	
E 87.7	16
Not-Halt Relais Hauptverteilung	

=.9-7D6.1
=.9/7.6

<p>CAD! KEINE MANUELLEN AENDERUNGEN! CAD! DONT CHANGE MANUAL</p>			 <p>Herrenknecht AG Schlehenweg 2 D-77963 Schwanau 2 Tel.: 07824 302-0 Fax.: 07824 3403 Info@Herrenknecht.de</p>	<p>Projekt: M-1642-C Not-Halt</p>		<p>Stueckliste: parts list: 25186184</p>		<p>Fg.-Gruppe: funct.-group: .22</p>		<p>Blatt-Nr.: page-nr.: 2</p>	
<p>Ausdruck-Datum: printout-date: 14.12.11</p>				<p>=Container</p>		<p>Emergency-Stop / Not-Aus</p>		<p>Blatt-Global: page-global: 120/166</p>		<p>von from 8</p>	
Index	Aenderung-Nr. Change No.:	Datum / Name date / name	<p>Zn.-Nr.: drawn-nr.: 3478-562-002-.22</p>		<p>Hauptverteilung main distribution board +HV/ MDB</p>		Datum: date: 26.08.2011	Bearb.: name: Th	<p>letzte Aenderung: last modification: IB-Revision 14.12.11 Th</p>		

Patent-, Gebrauchsmuster- oder
Geschmacksmuster-Eintragung vorbehalten.
of a patent, utility model or design.

ausdrücklich gestattet. Zuwiderhandlungen verpflichten
zu Schadensersatz. Alle Rechte fuer den Fall der
Autorisation ist prohibited. Offenders will be held liable for the
payment of damages. All rights reserved in the event of the grant

Weitergabe sowie Vervielfaeltigung dieses Dokuments, Verwertung
und Mitteilung seines Inhalts sind verboten, soweit nicht
The reproduction, distribution and utilization of this document as
well as the communication of its contents to others without express

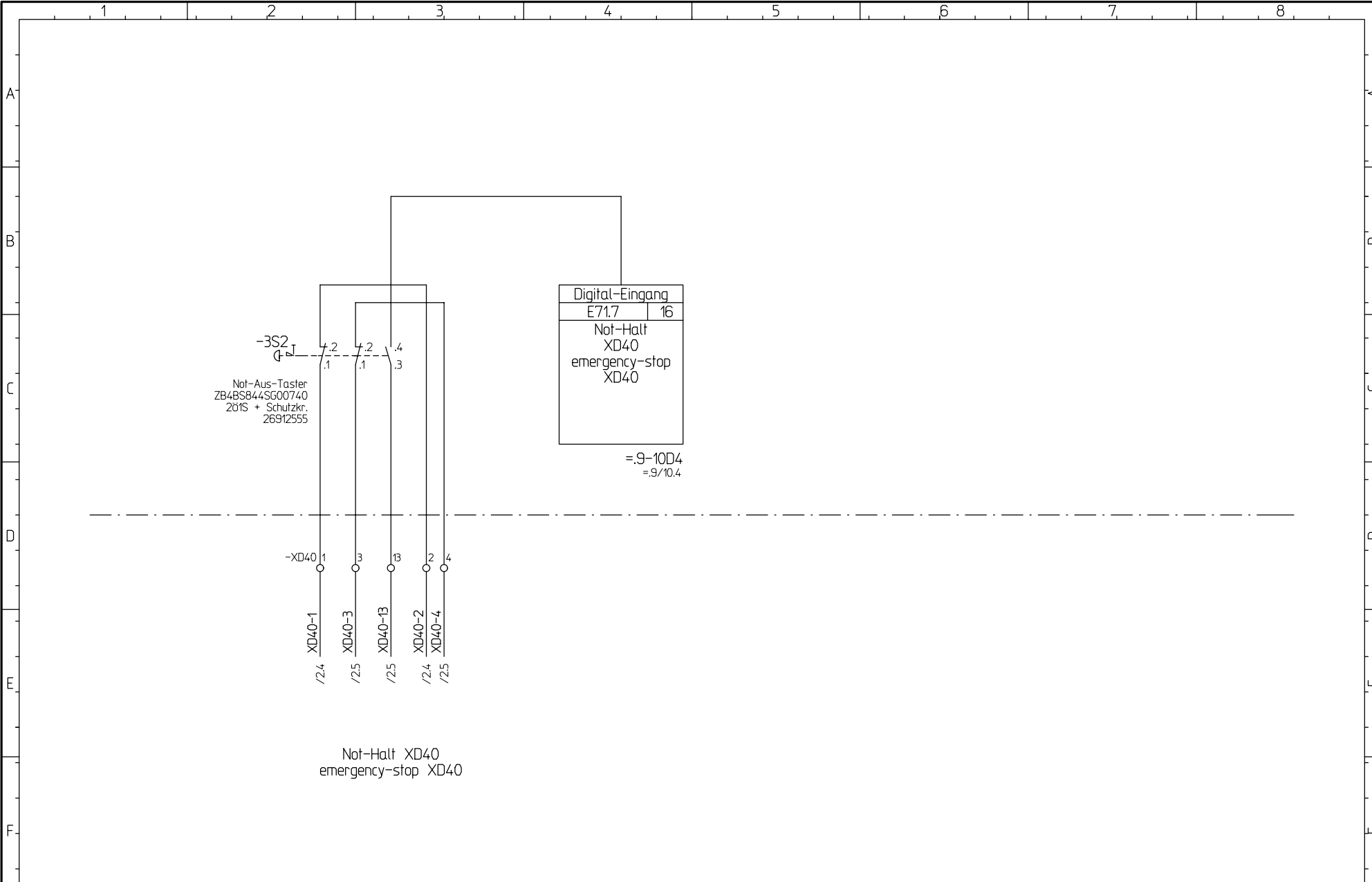

Index	Änderung-Nr. Change No.:	Datum / Name date / name
Index		

CAD! KEINE MANUELLEN
ÄNDERUNGEN!
CAD!
DONT CHANGE MANUAL

Ausdruck-Datum:
printout-date:
14.12.11



Herrenknecht AG
Schlehenweg 2
D-77963 Schwanau 2
Tel.: 07824 302-0
Fax.: 07824 3403
Info@Herrenknecht.de

Projekt:
project: M-1642-C
=Container
Zn.-Nr.:
drawn-nr.: 3478-562-002-.22

Not-Halt XD40
emergency-stop XD40
Emergency-Stop / Not-Aus
Aggregatedose XD40
+AGG_XD40
Datum:
date: 26.08.2011
Bearb.:
name: Th

Stueckliste:
parts list: 25186184
Fg.-Gruppe:
funct.-group: .22
Blatt-Nr.:
page-nr.: 3
Blatt-Global:
page-global: 121/166
von
from 8
letzte Aenderung:
last modification:
IB-Revision 14.12.11 Th

Patent-, Gebrauchsmuster- oder Geschmacksmuster-Eintragung vorbehalten.
 of a patent, utility model or design.
 ausdrucklich gestattet. Zuwiderhandlungen verpflichten zu Schadenersatz. Alle Rechte fuer den Fall der autorisation is prohibited. Offenders will be held liable for the payment of damages. All rights reserved in the event of the grant
 Weitergabe sowie Vervielfaeltigung dieses Dokuments, Verwertung und Mitteilung seines Inhalts sind verboten, soweit nicht The reproduction, distribution and utilization of this document as well as the communication of its contents to others without express

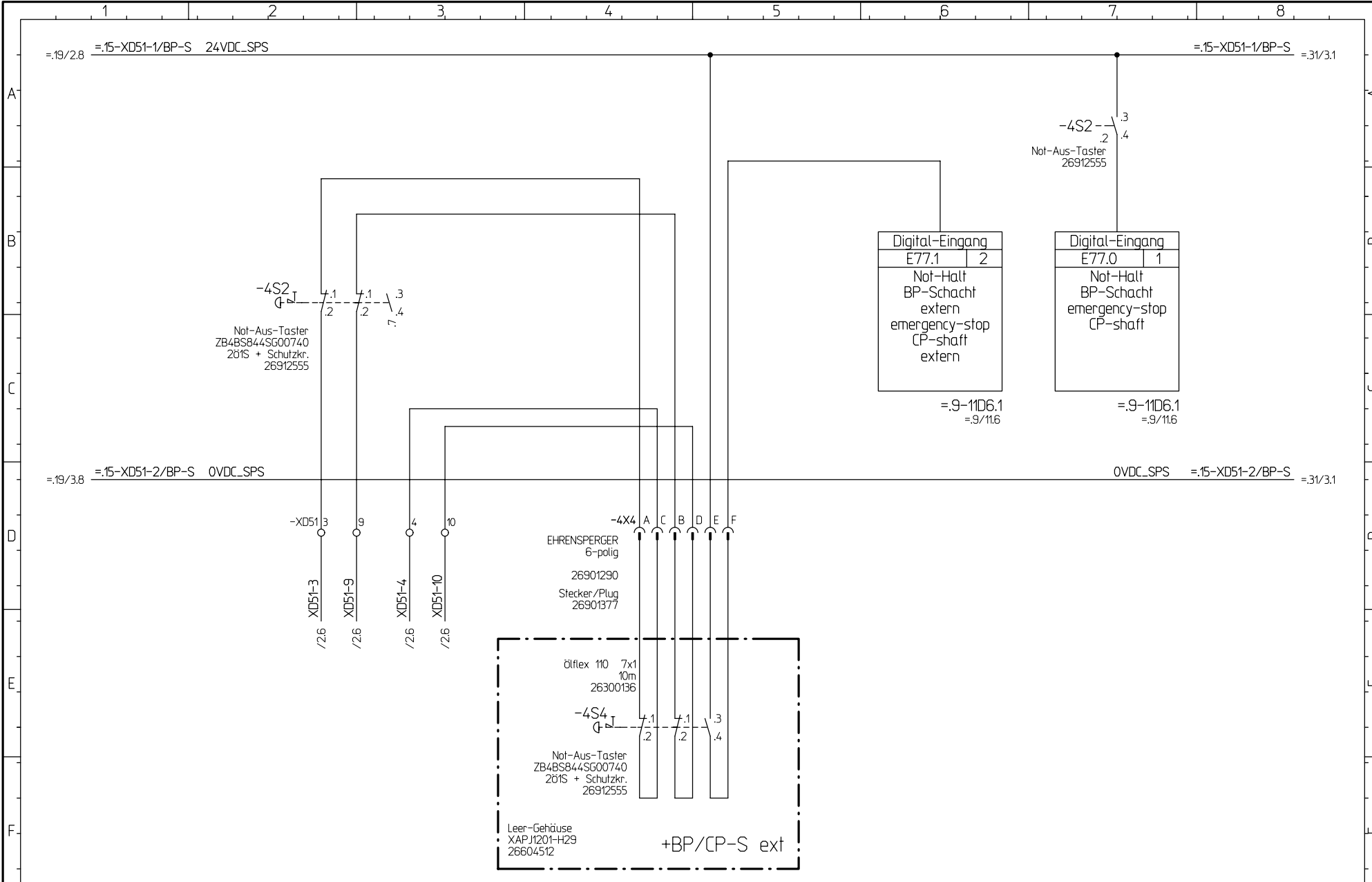

			CAD! KEINE MANUELLEN AENDERUNGEN! CAD! DONT CHANGE MANUAL		Herrenknecht AG Schlehenweg 2 D-77963 Schwanau 2 Tel.: 07824 302-0 Fax.: 07824 3403 Info@Herrenknecht.de		Projekt: M-1642-C =Container		Not-Halt BP-Schacht Emergency-Stop / Not-Aus		Stueckliste: 25186184 Fg.-Gruppe: .22 Blatt-Nr.: 4	
Index	Aenderung-Nr. Change No.:	Datum / Name date / name	Ausdruck-Datum: printout-date: 14.12.11				Zn.-Nr.: 3478-562-002-.22 drawn-nr.:		Bedienpult Schacht control panel shaft +BP/CP-S		Blatt-Global: 122/166 von from 8	
							Datum: date: 26.08.2011		Bearb.: name: Th		letzte Aenderung: last modification: 14.12.11 Th	

Patent-, Gebrauchsmuster- oder Geschmacksmuster-Eintragung vorbehalten.
 of a patent, utility model or design.
 ausdrucklich gestattet. Zuwiderhandlungen verpflichten zu Schadenersatz. Alle Rechte fuer den Fall der autorisation is prohibited. Offenders will be held liable for the payment of damages. All rights reserved in the event of the grant
 Weitergabe sowie Vervielfaeltigung dieses Dokuments, Verwertung und Mitteilung seines Inhalts sind verboten, soweit nicht The reproduction, distribution and utilization of this document as well as the communication of its contents to others without express

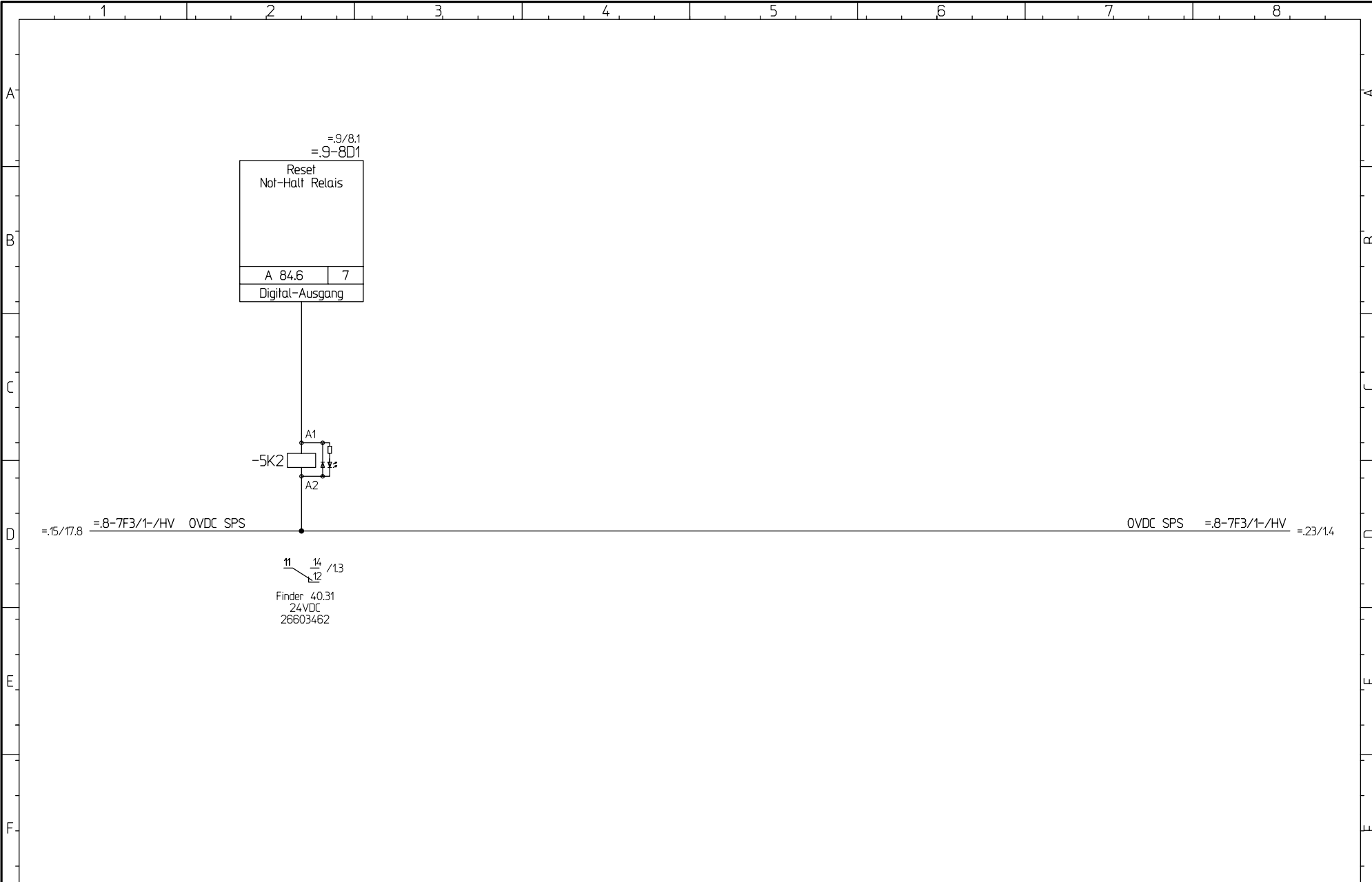

			CAD! KEINE MANUELLEN AENDERUNGEN! CAD! DONT CHANGE MANUAL		 Herrenknecht AG Schlehenweg 2 D-77963 Schwanau 2 Tel.: 07824 302-0 Fax.: 07824 3403 Info@Herrenknecht.de		Projekt: M-1642-C project: =Container		Reset Not-Halt Relais Emergency-Stop / Not-Aus		Stueckliste: 25186184 parts list:		Fg.-Gruppe: .22 funct.-group:		Blatt-Nr.: 5 page-nr.:			
Ausdruck-Datum: 14.12.11 printout-date:							Zn.-Nr.: 3478-562-002-.22 drawn-nr.:		Hauptverteilung main distribution board +HV/ MDB		Datum: 26.08.2011 date:		Bearb.: Th name:		letzte Aenderung: 14.12.11 Th last modification:		Blatt-Global: 123/166 page-global:	

Patent-, Gebrauchsmuster- oder
Geschmacksmuster-Eintragung vorbehalten.
of a patent, utility model or design.

ausdrücklich gestattet. Zuwiderhandlungen verpflichten
zu Schadenersatz. Alle Rechte fuer den Fall der
Auhorisation ist prohibited. Offenders will be held liable for the
payment of damages. All rights reserved in the event of the grant

Weitergabe sowie Vervielfaeltigung dieses Dokuments, Verwertung
und Mitteilung seines Inhalts sind verboten, soweit nicht
The reproduction, distribution and utilization of this document as
well as the communication of its contents to others without express

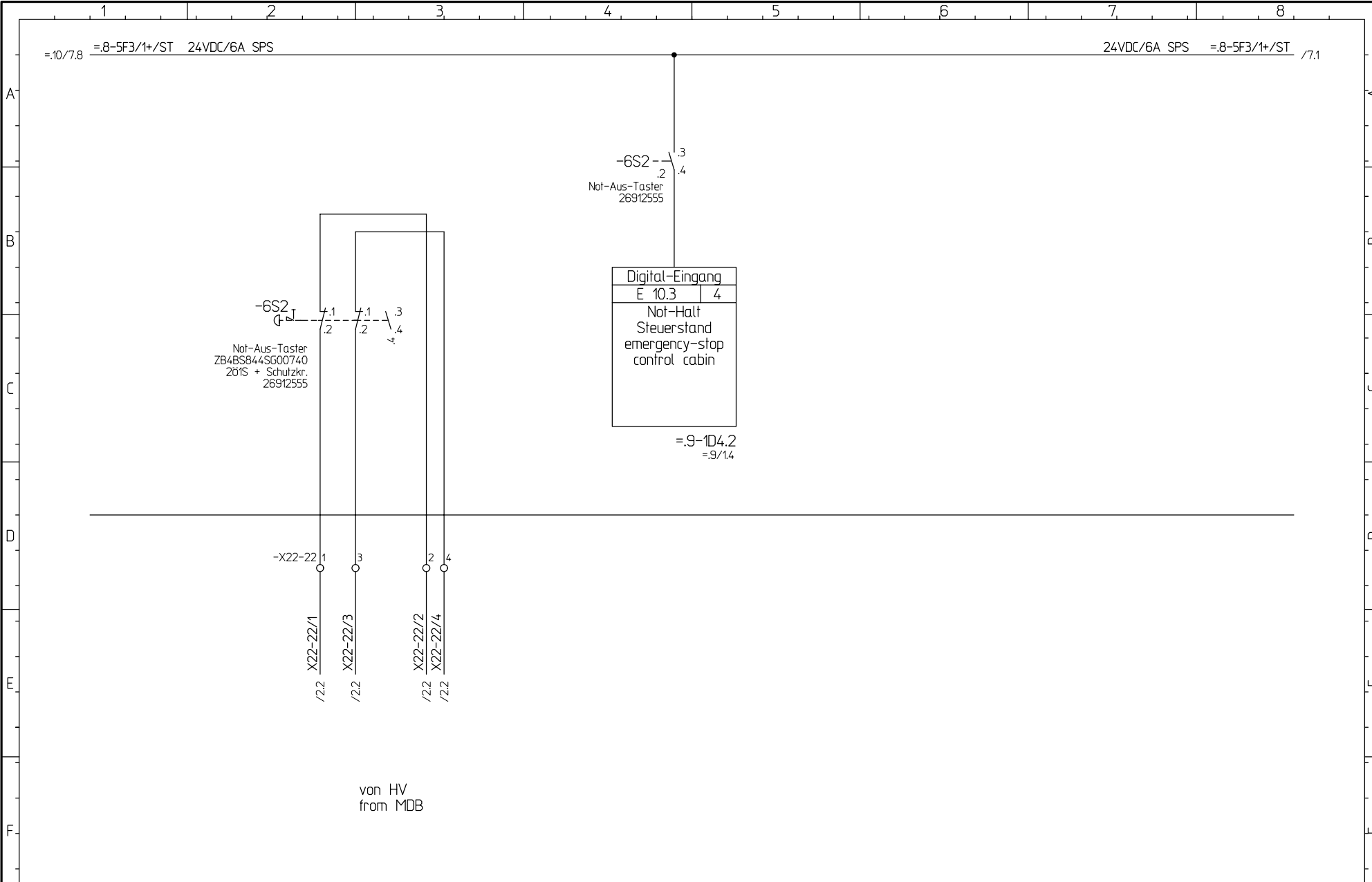

Index	Aenderung-Nr. Change No.:	Datum / Name date / name
Index		

CAD! KEINE MANUELLEN
AENDERUNGEN!
CAD!
DONT CHANGE MANUAL

Ausdruck-Datum:
printout-date:
14.12.11



Herrenknecht AG
Schlehenweg 2
D-77963 Schwanau 2
Tel.: 07824 302-0
Fax.: 07824 3403
Info@Herrenknecht.de

Projekt:
project: M-1642-C

=Container

Zn.-Nr.:
drawn-nr.: 3478-562-002-.22

Not-Halt/Wartungsschalter Steuerstand

Emergency-Stop / Not-Aus

Steuerstand
Control Cabin
+ST/CC

Stueckliste:
parts list: 25186184

Fg.-Gruppe:
funct.-group: .22

Blatt-Nr.:
page-nr.: 6

Blatt-Global:
page-global: 124/166

von
from 8

Datum:
date: 26.08.2011

Bearb. name:
name: Th

letzte Aenderung:
last modification:
IB-Revision 14.12.11 Th

Patent-, Gebrauchsmuster- oder Geschmacksmuster-Eintragung vorbehalten.
 of a patent, utility model or design.
 ausdrucklich gestattet. Zuwiderhandlungen verpflichten zu Schadenersatz. Alle Rechte fuer den Fall der autorisation is prohibited. Offenders will be held liable for the payment of damages. All rights reserved in the event of the grant
 Weitergabe sowie Vervielfaeltigung dieses Dokuments, Verwertung und Mitteilung seines Inhalts sind verboten, soweit nicht The reproduction, distribution and utilization of this document as well as the communication of its contents to others without express

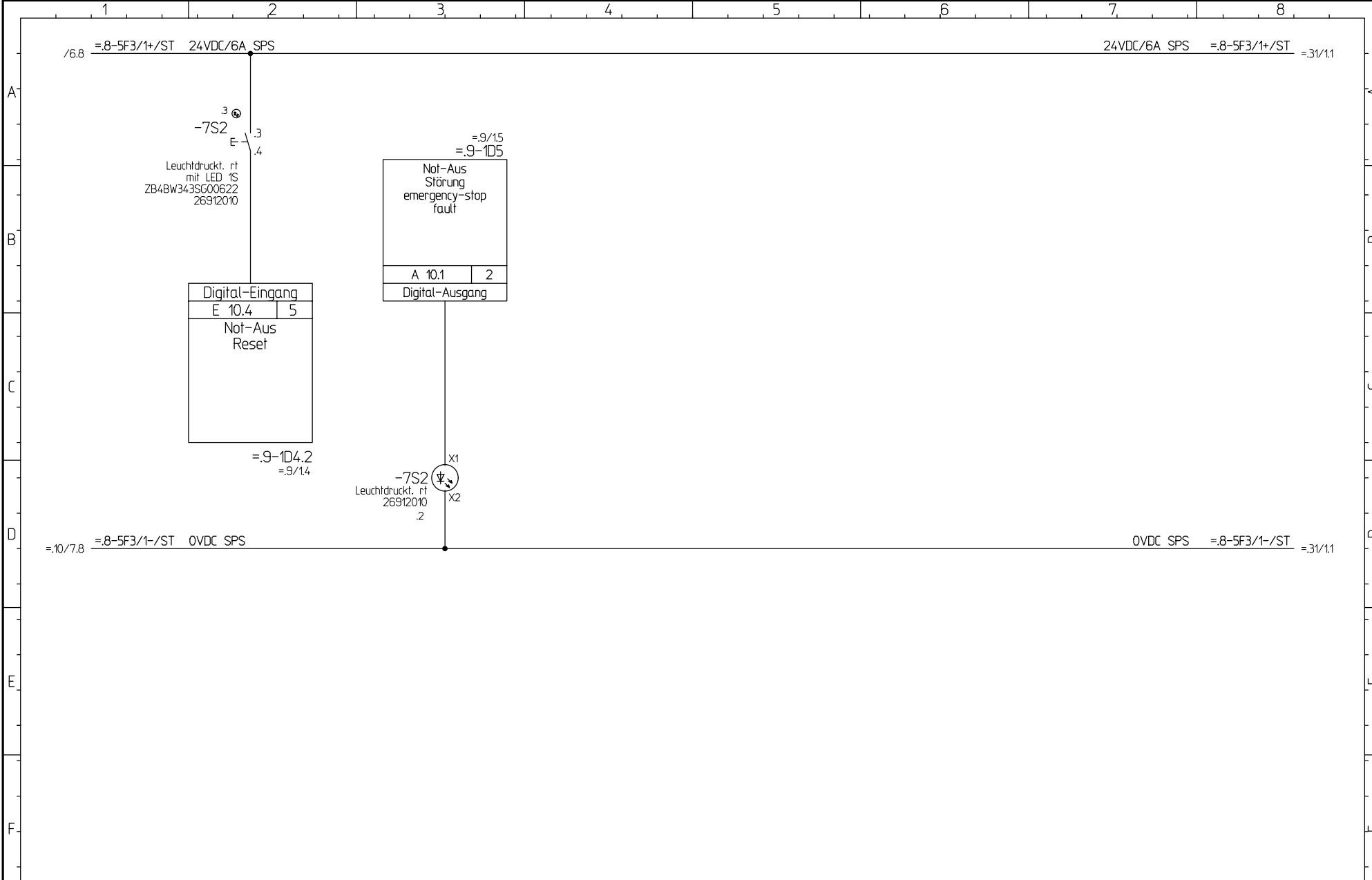



			CAD! KEINE MANUELLEN AENDERUNGEN! CAD! DONT CHANGE MANUAL		 Herrenknecht AG Schlehenweg 2 D-77963 Schwanau 2 Tel.: 07824 302-0 Fax.: 07824 3403 Info@Herrenknecht.de		Projekt: M-1642-C		Reset/Störung Not-Halt		Stueckliste: parts list: 25186184		Fg.-Gruppe: funct.-group: .22		Blatt-Nr.: page-nr.: 7	
			Ausdruck-Datum: printout-date: 14.12.11				=Container		Emergency-Stop / Not-Aus		Steuerstand Control Cabin +ST/CC		Datum: date: 26.08.2011		Bearb.: name: Th	
Index Index			Aenderung-Nr. Change No.:		Datum / Name date / name		Zn.-Nr.: drawn-nr.: 3478-562-002-.22						Blatt-Global: page-global: 125/166		von from 8	

Patent-, Gebrauchsmuster- oder
Geschmacksmuster-Eintragung vorbehalten.
of a patent, utility model or design.

ausdruecklich gestattet. Zuwiderhandlungen verpflichten
zu Schadensersatz. Alle Rechte fuer den Fall der
Auhorisation is prohibited. Offenders will be held liable for the
payment of damages. All rights reserved in the event of the grant

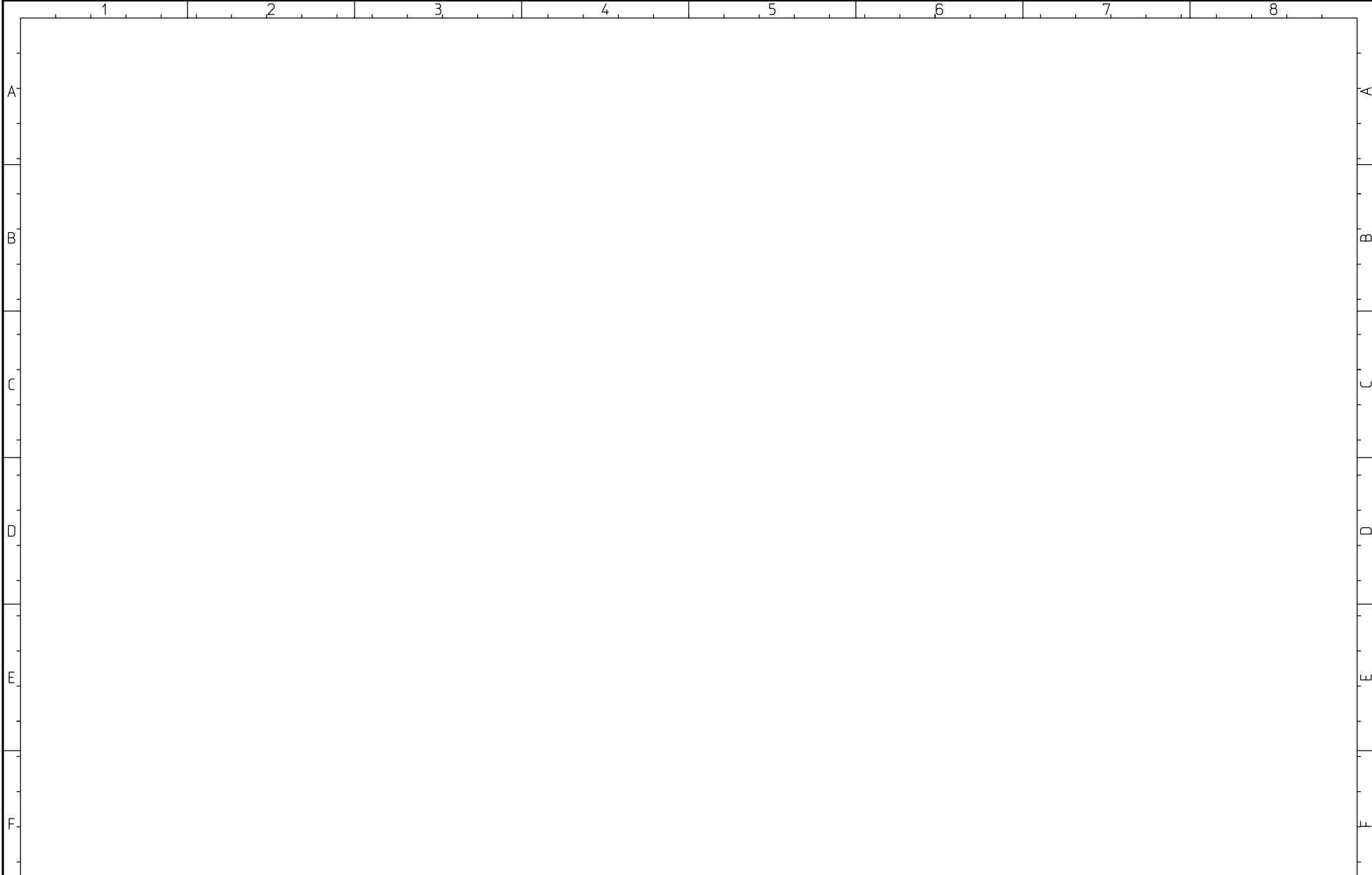
Weitergabe sowie Vervielfaeltigung dieses Dokuments, Verwertung
und Mitteilung seines Inhalts sind verboten, soweit nicht
The reproduction, distribution and utilization of this document as
well as the communication of its contents to others without express



			CAD! KEINE MANUELLEN AENDERUNGEN ! CAD! DONT CHANGE MANUAL	 Herrenknecht AG Schlehenweg 2 D-77963 Schwanau 2 Tel.: 07824 302-0 Fax.: 07824 3403 Info@Herrenknecht.de	Projekt: project: M-1642-C	Reserve reserve	Stueckliste: parts list: 25186184	Fg.-Gruppe: funct.-group: .22	Blatt-Nr.: page-nr.: 8	
Index Index	Aenderung-Nr. Change No.:	Datum / Name date / name	Ausdruck-Datum: printout-date: 14.12.11		=Container	Zn.-Nr.: drawn-nr.: 3478-562-002-.22	Datum: date: 26.08.2011	Bearb.: name: Th	letzte Aenderung: last modification: 14.12.11 Th	Blatt-Global: page-global: 126/166

Patent-, Gebrauchsmuster- oder Geschmacksmuster-Eintragung vorbehalten.
 of a patent, utility model or design.
 ausdrucklich gestattet. Zuwiderhandlungen verpflichten zu Schadenersatz. Alle Rechte fuer den Fall der autorisation is prohibited. Offenders will be held liable for the payment of damages. All rights reserved in the event of the grant
 Weitergabe sowie Vervielfaeltigung dieses Dokuments, Verwertung und Mitteilung seines Inhalts sind verboten, soweit nicht The reproduction, distribution and utilization of this document as well as the communication of its contents to others without express

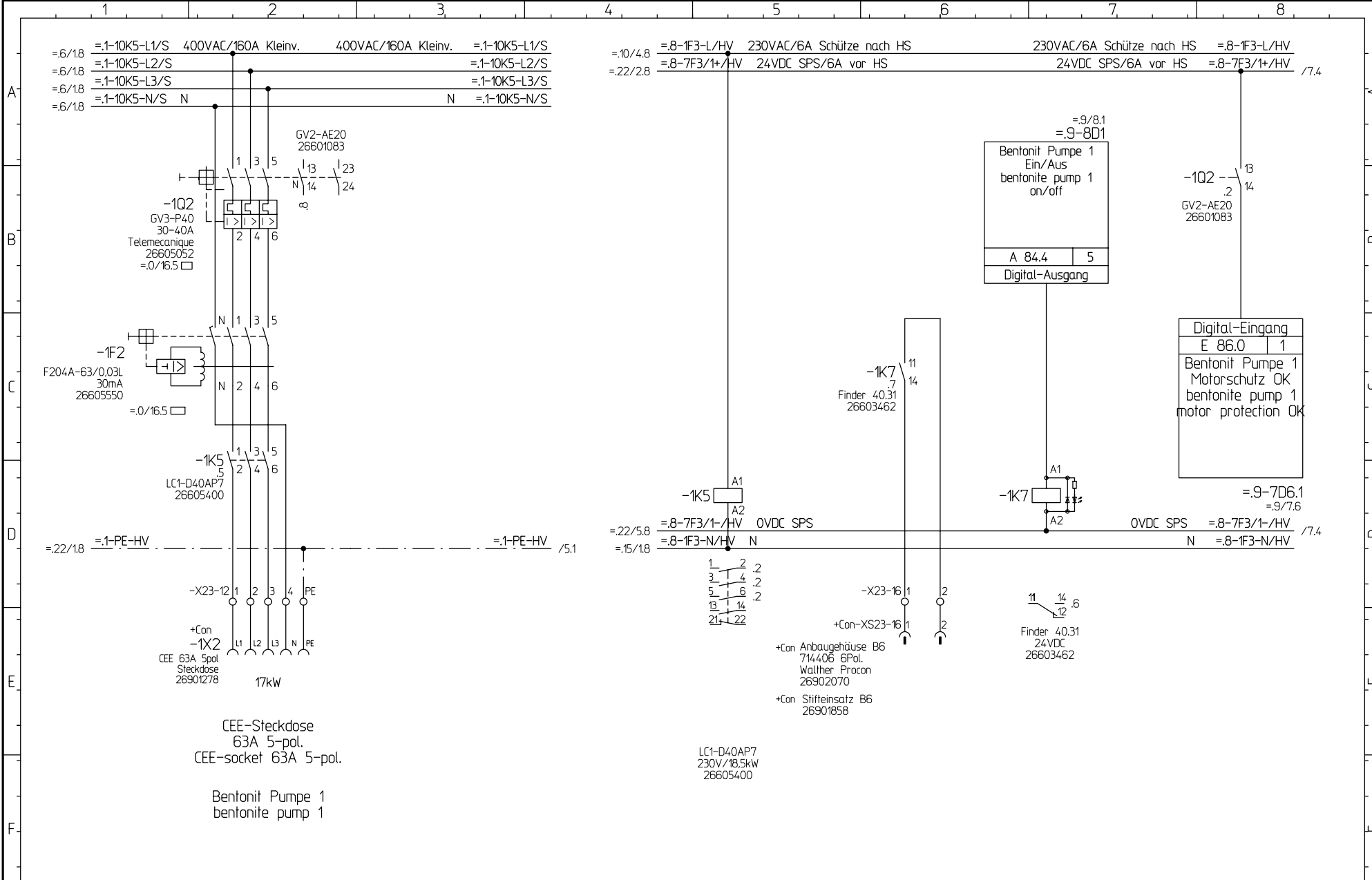

Index	Änderung-Nr. Change No.:	Datum / Name date / name
Index		

CAD! KEINE MANUELLEN
 ÄNDERUNGEN!
 CAD!
 DONT CHANGE MANUAL
 Ausdruck-Datum:
 printout-date:
 14.12.11



Herrenknecht AG
 Schlehenweg 2
 D-77963 Schwanau 2
 Tel.: 07824 302-0
 Fax.: 07824 3403
 Info@Herrenknecht.de

Projekt: project:	M-1642-C
Zn.-Nr.:	
drawn-nr.:	3478-562-002-.23

Bentonit Pumpe 1 bentonite pump 1	Stueckliste: parts list:	Fg.-Gruppe: func.-group:	Blatt-Nr.:
Bentonitschmier. / bentonite lubrication	25186184	.23	1
Hauptverteilung main distribution board	Datum: date:	Bearb.:	letzte Aenderung: last modification:
+HV/MDB	26.08.2011	Th	IB-Revision 14.12.11 Th

Blatt-Global: page-global:	von from
127/166	10

Patent-, Gebrauchsmuster- oder
Geschmacksmuster-Eintragung vorbehalten.
of a patent, utility model or design.

ausdruecklich gestattet. Zuwiderhandlungen verpflichten
zu Schadensersatz. Alle Rechte fuer den Fall der
Auhorisation is prohibited. Offenders will be held liable for the
payment of damages. All rights reserved in the event of the grant

Weitergabe sowie Vervielfaeltigung dieses Dokuments, Verwertung
und Mitteilung seines Inhalts sind verboten, soweit nicht
The reproduction, distribution and utilization of this document as
well as the communication of its contents to others without express

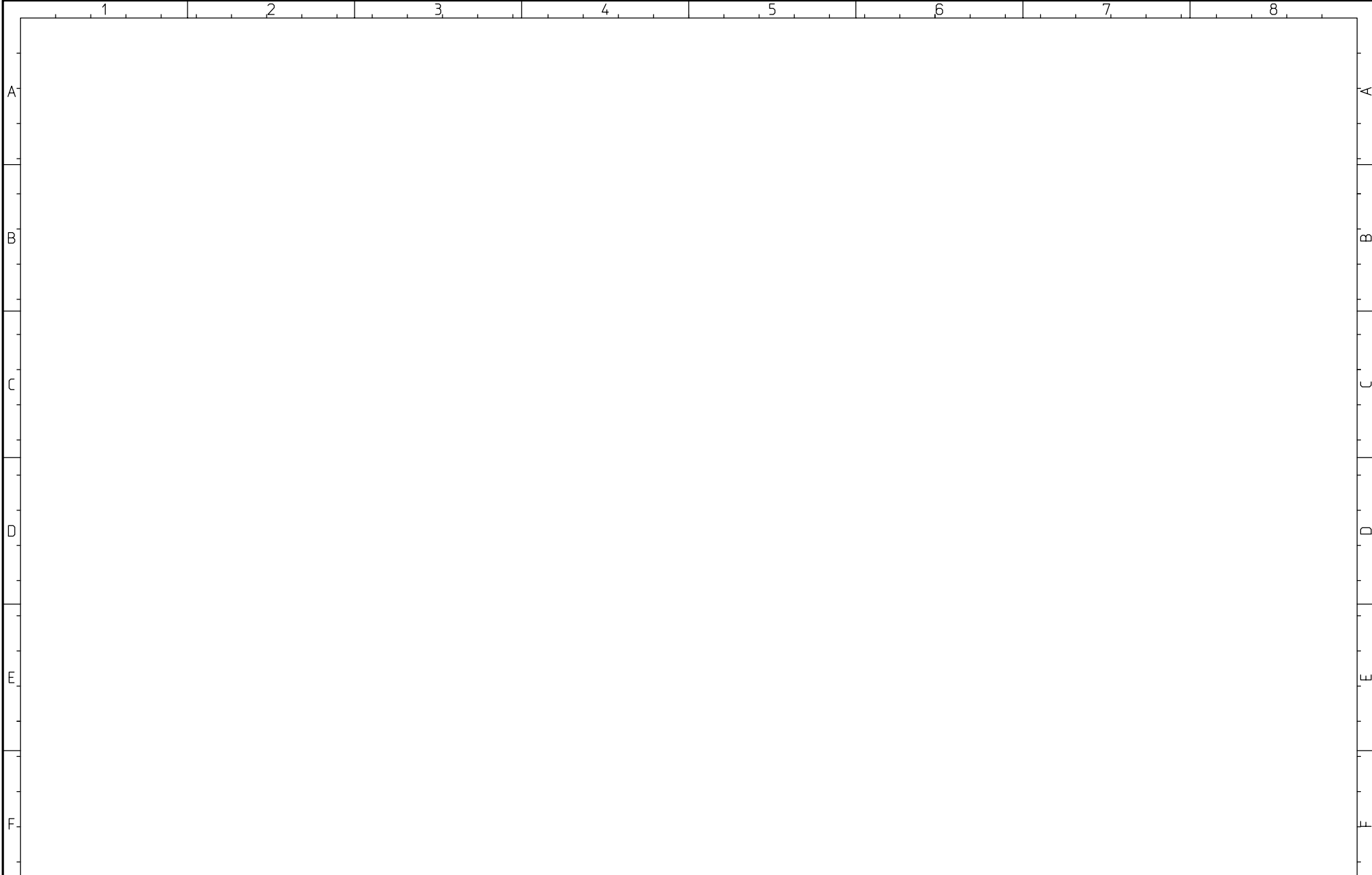



			CAD! KEINE MANUELLEN AENDERUNGEN ! CAD! DONT CHANGE MANUAL	 Herrenknecht AG Schlehenweg 2 D-77963 Schwanau 2 Tel.: 07824 302-0 Fax.: 07824 3403 Info@Herrenknecht.de	Projekt: project: M-1642-C	Reserve reserve	Stueckliste: parts list: 25186184	Fg.-Gruppe: funct.-group: .23	Blatt-Nr.: page-nr.: 2	
Index Index	Aenderung-Nr. Change No.:	Datum / Name date / name	Ausdruck-Datum: printout-date: 14.12.11		=Container	Zn.-Nr.: drawn-nr.: 3478-562-002-.23	Datum: date: 26.08.2011	Bearb.: name: Th	letzte Aenderung: last modification: 14.12.11 Th	Blatt-Global: page-global: 128/166

Patent-, Gebrauchsmuster- oder
Geschmacksmuster-Eintragung vorbehalten.
of a patent, utility model or design.

ausdruecklich gestattet. Zuwiderhandlungen verpflichten
zu Schadensersatz. Alle Rechte fuer den Fall der
Auhorisation is prohibited. Offenders will be held liable for the
payment of damages. All rights reserved in the event of the grant

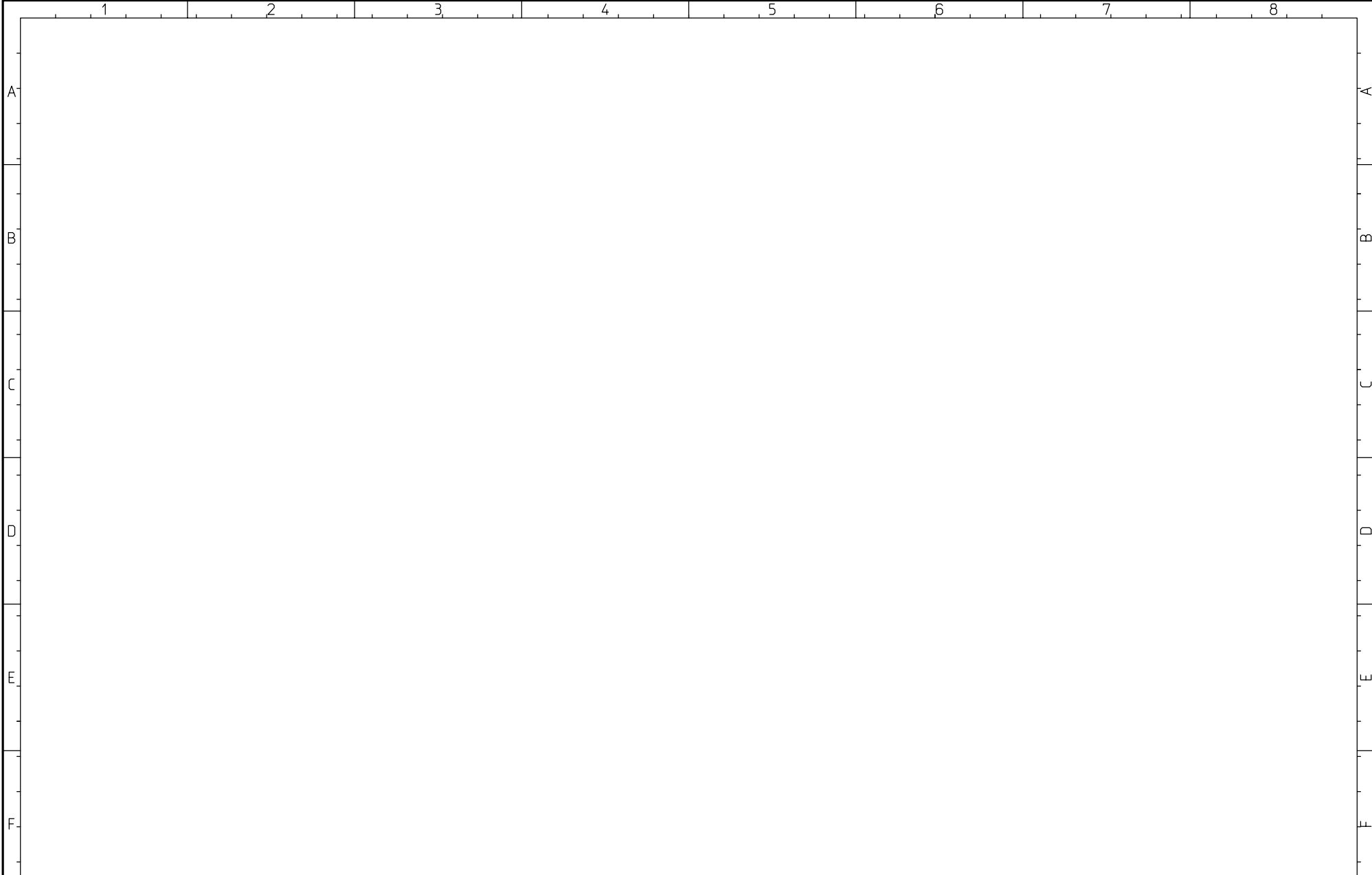
Weitergabe sowie Vervielfaeltigung dieses Dokuments, Verwertung
und Mitteilung seines Inhalts sind verboten, soweit nicht
The reproduction, distribution and utilization of this document as
well as the communication of its contents to others without express





			CAD! KEINE MANUELLEN AENDERUNGEN ! CAD! DONT CHANGE MANUAL	 Herrenknecht AG Schlehenweg 2 D-77963 Schwanau 2 Tel.: 07824 302-0 Fax.: 07824 3403 Info@Herrenknecht.de	Projekt: project: M-1642-C	Reserve reserve	Stueckliste: parts list: 25186184	Fg.-Gruppe: funct.-group: .23	Blatt-Nr.: page-nr.: 3	
Index Index	Aenderung-Nr. Change No.:	Datum / Name date / name	Ausdruck-Datum: printout-date: 14.12.11		=Container	Zn.-Nr.: drawn-nr.: 3478-562-002-.23	Datum: date: 26.08.2011	Bearb.: name: Th	letzte Aenderung: last modification: 14.12.11 Th	Blatt-Global: page-global: 129/166

Patent-, Gebrauchsmuster- oder Geschmacksmuster-Eintragung vorbehalten.
 of a patent, utility model or design.

ausdrücklich gestattet. Zuwiderhandlungen verpflichten zu Schadensersatz. Alle Rechte fuer den Fall der Autorisation ist prohibited. Offenders will be held liable for the payment of damages. All rights reserved in the event of the grant

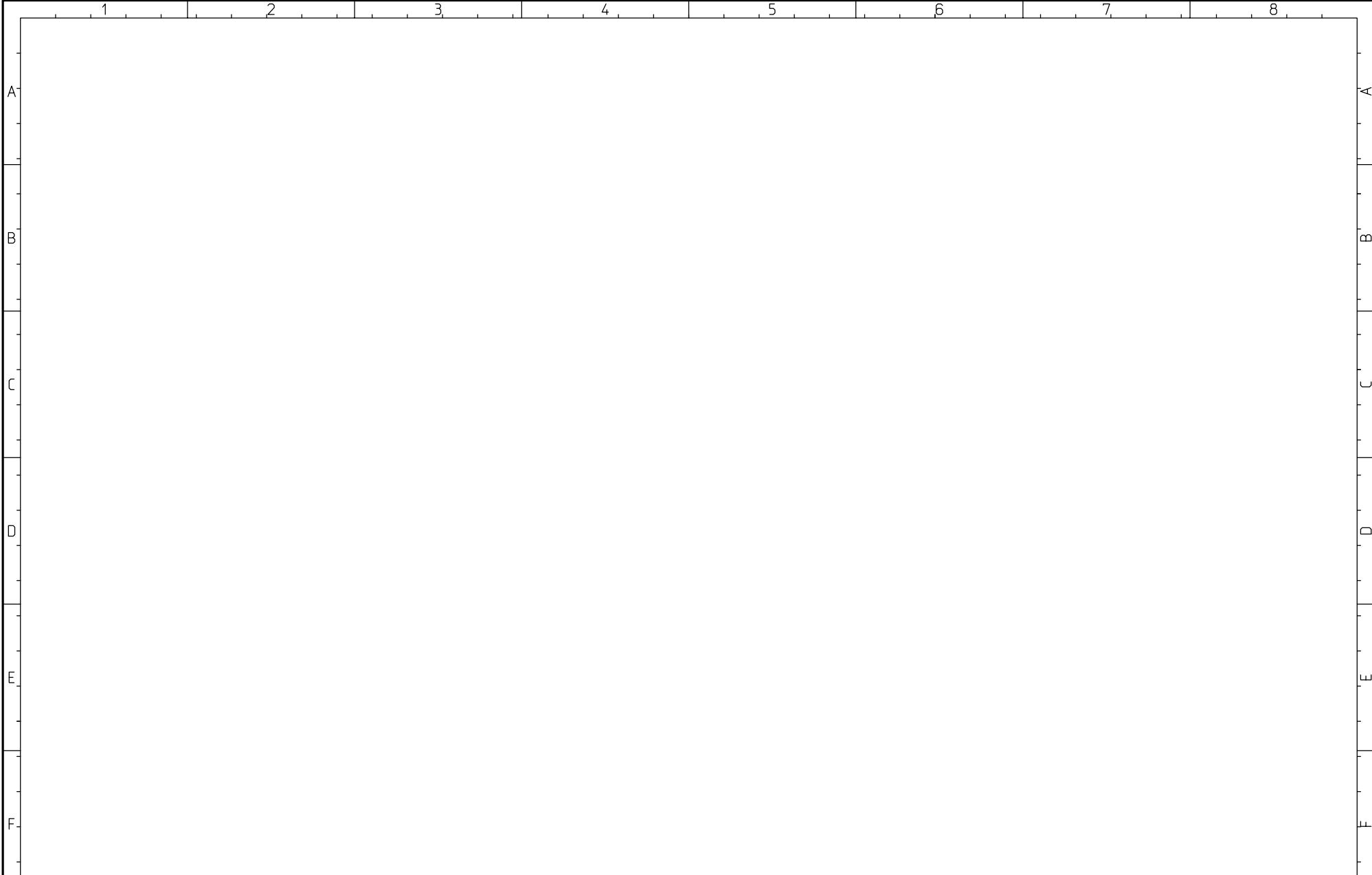
Weitergabe sowie Vervielfaeltigung dieses Dokuments, Verwertung und Mitteilung seines Inhalts sind verboten, soweit nicht The reproduction, distribution and utilization of this document as well as the communication of its contents to others without express



			CAD! KEINE MANUELLEN AENDERUNGEN ! CAD! DONT CHANGE MANUAL	 Herrenknecht AG Schlehenweg 2 D-77963 Schwanau 2 Tel.: 07824 302-0 Fax.: 07824 3403 Info@Herrenknecht.de	Projekt: project: M-1642-C	Reserve reserve	Stueckliste: parts list: 25186184	Fg.-Gruppe: funct.-group: .23	Blatt-Nr.: page-nr.: 4	
Index Index	Aenderung-Nr. Change No.:	Datum / Name date / name	Ausdruck-Datum: printout-date: 14.12.11		=Container	Zn.-Nr.: drawn-nr.: 3478-562-002-.23	Datum: date: 26.08.2011	Bearb.: name: Th	letzte Aenderung: last modification: 14.12.11 Th	Blatt-Global: page-global: 130/166

Patent-, Gebrauchsmuster- oder Geschmacksmuster-Eintragung vorbehalten. of a patent, utility model or design.
 ausdrucklich gestattet. Zuwendungen verpflichten zu Schadensersatz. Alle Rechte fuer den Fall der authorisation is prohibited. Offenders will be held liable for the payment of damages. All rights reserved in the event of the grant
 Weitergabe sowie Vervielfaeltigung dieses Dokuments, Verwertung und Mitteilung seines Inhalts sind verboten, soweit nicht The reproduction, distribution and utilization of this document as well as the communication of its contents to others without express

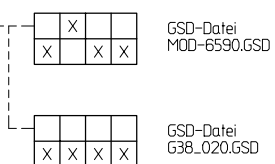
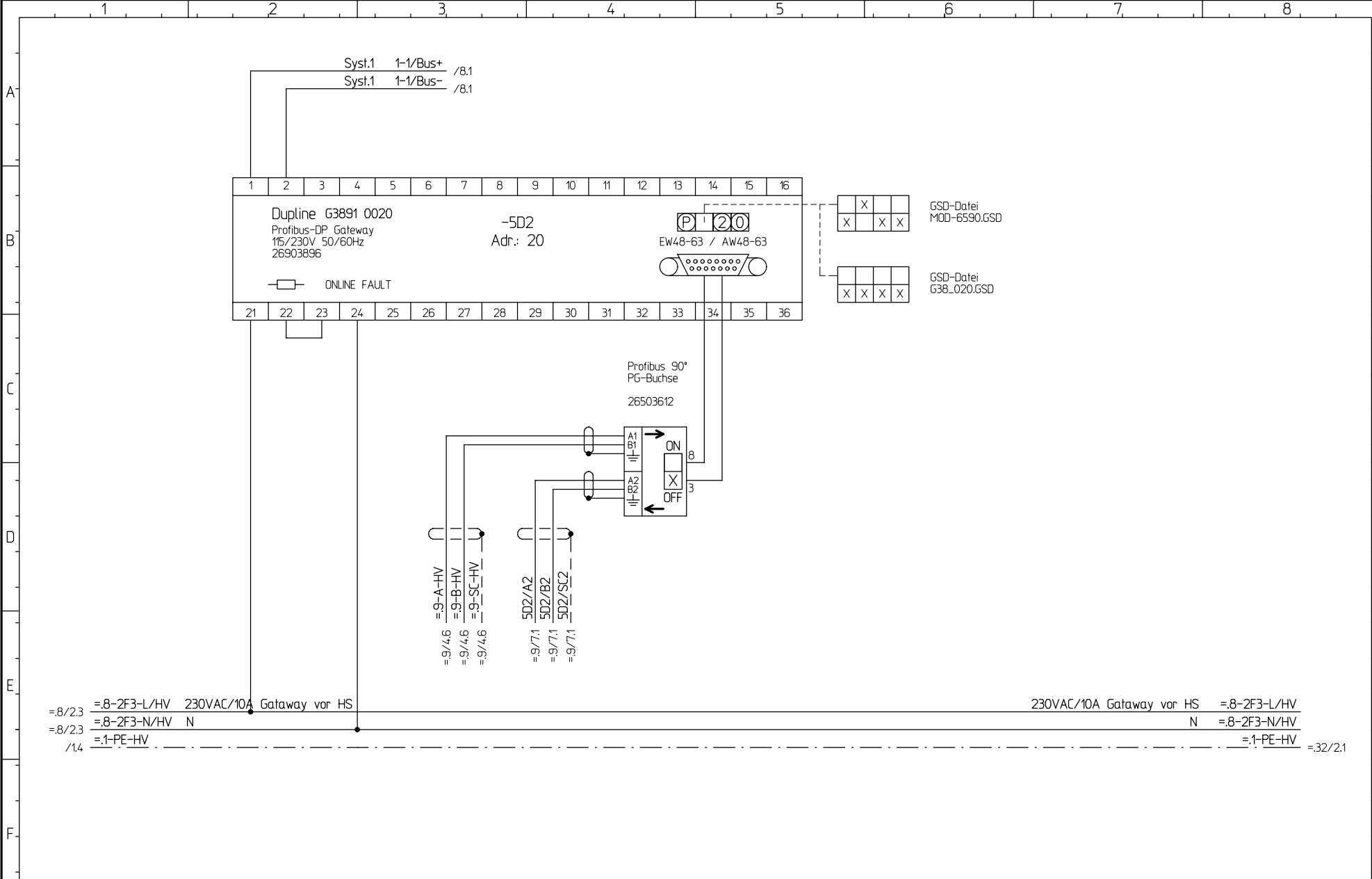



			CAD! KEINE MANUELLEN AENDERUNGEN! CAD! DONT CHANGE MANUAL		 Herrenknecht AG Schlehenweg 2 D-77963 Schwanau 2 Tel.: 07824 302-0 Fax.: 07824 3403 Info@Herrenknecht.de	Projekt: M-1642-C =Container		Profibus Gateway System 1/1 process data highway gateway system 1/1 Bentonitschmier. / bentonite lubrication		Stueckliste: parts list: 25186184		Fg.-Gruppe: funct.-group: .23		Blatt-Nr.: page-nr.: 5				
			Ausdruck-Datum: printout-date: 14.12.11			Zn.-Nr.: drawn-nr.: 3478-562-002-.23		Hauptverteilung main distribution board +HV/MDB		Datum: date: 26.08.2011		Bearb.: name: Th		letzte Aenderung: last modification: IB-Revision 14.12.11 Th		Blatt-Global: page-global: 131/166		von from 10

Patent-, Gebrauchsmuster- oder
Geschmacksmuster-Eintragung vorbehalten.
of a patent, utility model or design.

ausdruecklich gestattet. Zuwiderhandlungen verpflichten
zu Schadensersatz. Alle Rechte fuer den Fall der
Auhorisation is prohibited. Offenders will be held liable for the
payment of damages. All rights reserved in the event of the grant

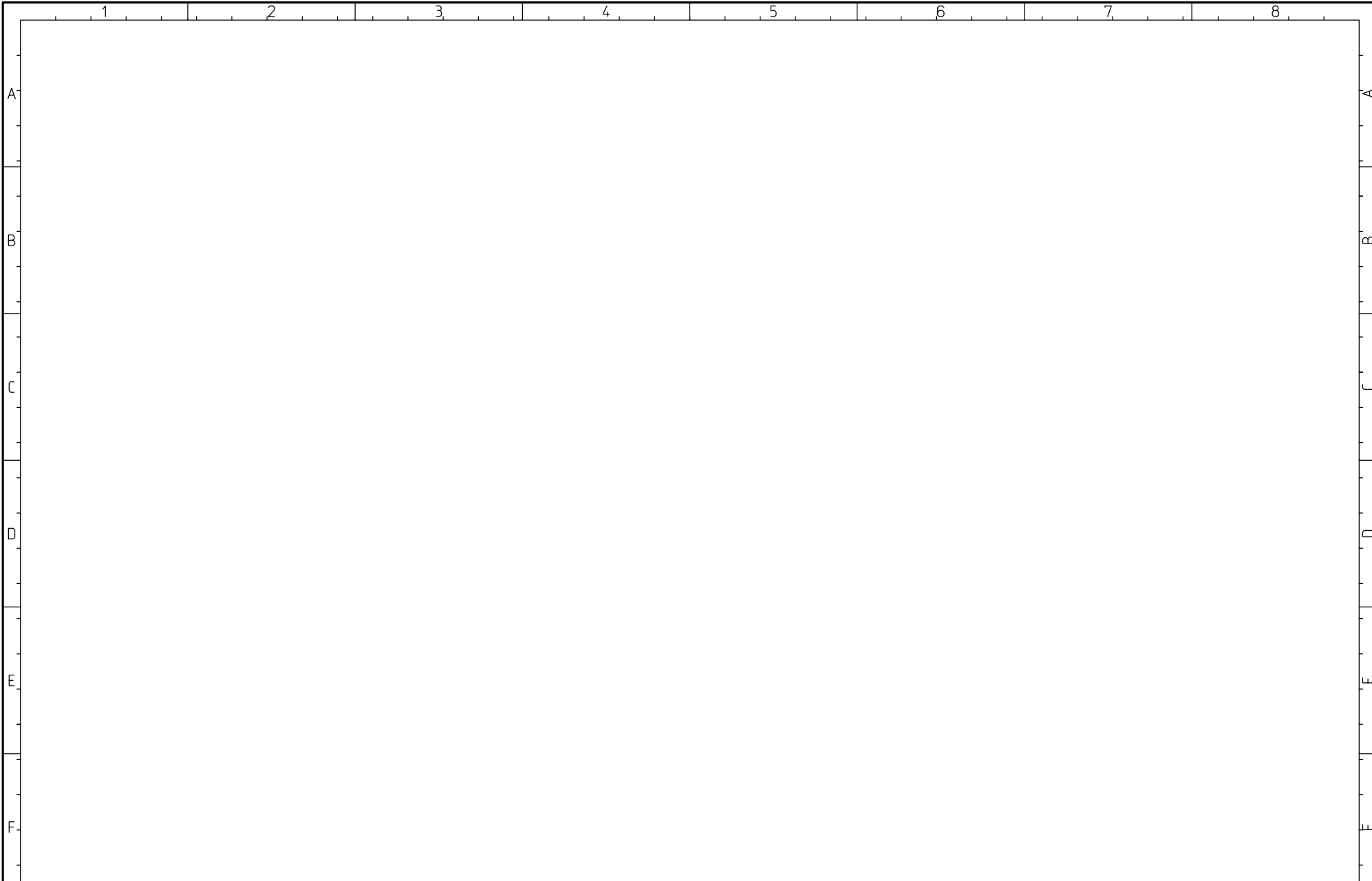
Weitergabe sowie Vervielfaeltigung dieses Dokuments, Verwertung
und Mitteilung seines Inhalts sind verboten, soweit nicht
The reproduction, distribution and utilization of this document as
well as the communication of its contents to others without express



			CAD! KEINE MANUELLEN AENDERUNGEN ! CAD! DONT CHANGE MANUAL	 Herrenknecht AG Schlehenweg 2 D-77963 Schwanau 2 Tel.: 07824 302-0 Fax.: 07824 3403 Info@Herrenknecht.de	Projekt: project: M-1642-C	Reserve reserve	Stueckliste: parts list: 25186184	Fg.-Gruppe: funct.-group: .23	Blatt-Nr.: page-nr.: 6	
Index Index	Aenderung-Nr. Change No.:	Datum / Name date / name	Ausdruck-Datum: printout-date: 14.12.11		=Container	Zn.-Nr.: drawn-nr.: 3478-562-002-.23	Datum: date: 26.08.2011	Bearb.: name: Th	letzte Aenderung: last modification: IB-Revision 14.12.11 Th	Blatt-Global: page-global: 132/166

Patent-, Gebrauchsmuster- oder Geschmacksmuster-Eintragung vorbehalten. of a patent, utility model or design.
 ausdrucklich gestattet. Zuwiderhandlungen verpflichten zu Schadenersatz. Alle Rechte fuer den Fall der authorisation is prohibited. Offenders will be held liable for the payment of damages. All rights reserved in the event of the grant
 Weitergabe sowie Vervielfaeltigung dieses Dokuments, Verwertung und Mitteilung seines Inhalts sind verboten, soweit nicht The reproduction, distribution and utilization of this document as well as the communication of its contents to others without express

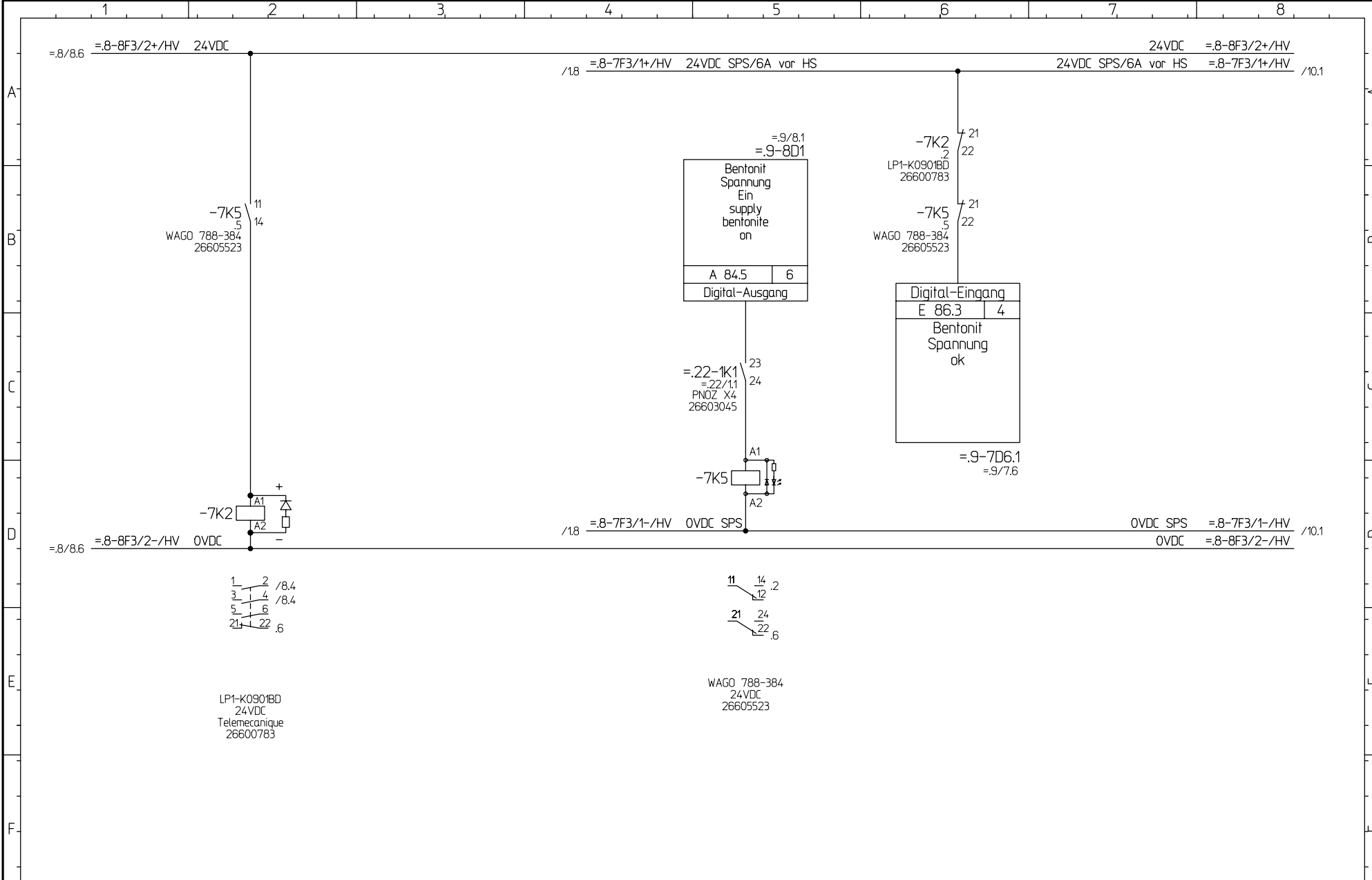



LP1-K0901BD
24VDC
Telemecanique
26600783

WAGO 788-384
24VDC
26605523

			CAD! KEINE MANUELLEN AENDERUNGEN! CAD! DONT CHANGE MANUAL		 Herrenknecht AG Schlehenweg 2 D-77963 Schwanaau 2 Tel.: 07824 302-0 Fax.: 07824 3403 Info@Herrenknecht.de	Projekt: M-1642-C Bentonit Spannung bentonite voltage		Stueckliste: parts list: 25186184		Fg.-Gruppe: funct.-group: .23		Blatt-Nr.: page-nr.: 7		
			Ausdruck-Datum: printout-date: 14.12.11			=Container		Bentonitschmier. / bentonite lubrication		Blatt-Global: page-global: 133/166		von from 10		
Index	Aenderung-Nr. Change No.:	Datum / Name date / name				Zn.-Nr. drawn-nr.:	Hauptverteilung main distribution board +HV/ MDB		Datum: date:	Bearb. name:	letzte Aenderung: last modification: 14.12.11 Th		IB-Revision 14.12.11 Th	
						3478-562-002-.23			26.08.2011	Th				

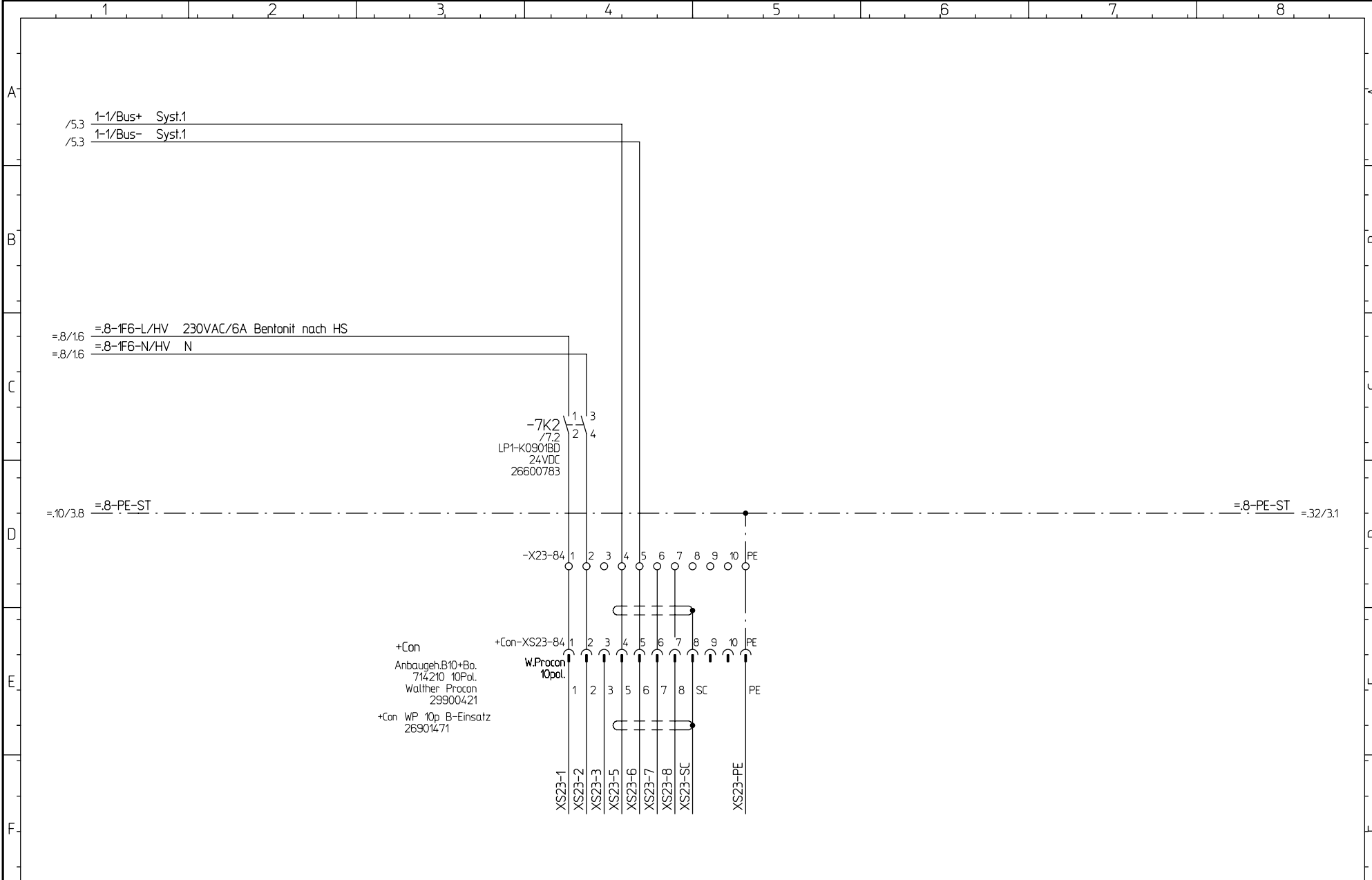
Patent-, Gebrauchsmuster- oder Geschmacksmuster-Eintragung vorbehalten.
 of a patent, utility model or design.
 ausdrucklich gestattet. Zuwiderhandlungen verpflichten zu Schadensersatz. Alle Rechte fuer den Fall der authorisation is prohibited. Offenders will be held liable for the payment of damages. All rights reserved in the event of the grant
 Weitergabe sowie Vervielfaeltigung dieses Dokuments, Verwertung und Mitteilung seines Inhalts sind verboten, soweit nicht The reproduction, distribution and utilization of this document as well as the communication of its contents to others without express





			CAD! KEINE MANUELLEN AENDERUNGEN! CAD! DONT CHANGE MANUAL		Herrenknecht AG Schlehenweg 2 D-77963 Schwanau 2 Tel.: 07824 302-0 Fax.: 07824 3403 Info@Herrenknecht.de		Projekt: M-1642-C =Container		Einspeisung Schmiersystem 1 supply lubrication system 1 Bentonitschmier. / bentonite lubrication		Stueckliste: parts list: 25186184	Fg.-Gruppe: funct.-group: .23	Blatt-Nr.: page-nr.: 8	
			Ausdruck-Datum: printout-date: 14.12.11				Zn.-Nr.: drawn-nr.: 3478-562-002-.23		Hauptverteilung main distribution board +HV/MBB	Datum: date: 26.08.2011	Bearb.: name: Th	letzte Aenderung: last modification: IB-Revision 14.12.11 Th	Blatt-Global: page-global: 134/166	von from 10

Patent-, Gebrauchsmuster- oder
Geschmacksmuster-Eintragung vorbehalten.
of a patent, utility model or design.

ausdruecklich gestattet. Zuwiderhandlungen verpflichten
zu Schadensersatz. Alle Rechte fuer den Fall der
Auhorisation is prohibited. Offenders will be held liable for the
payment of damages. All rights reserved in the event of the grant

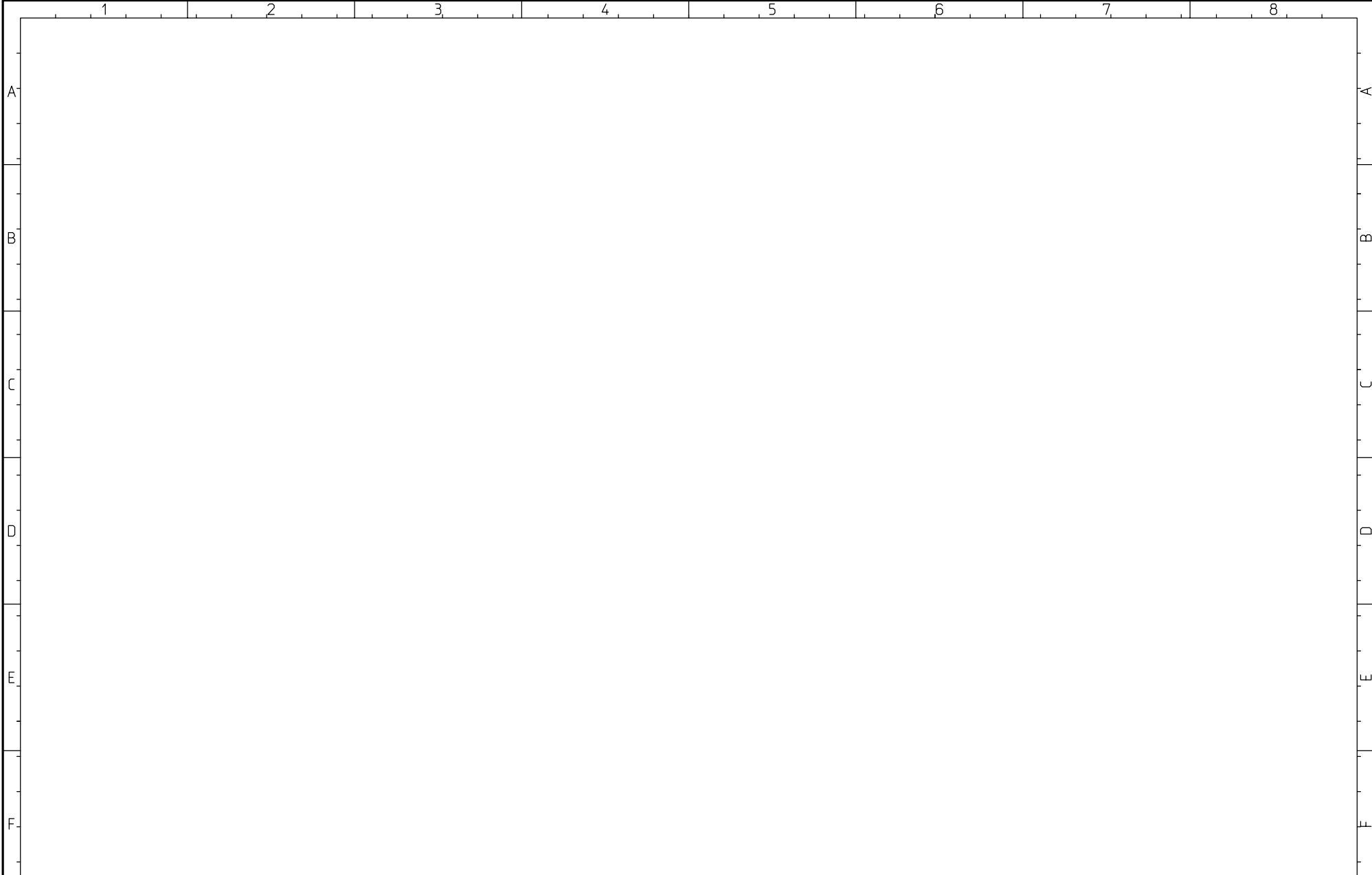
Weitergabe sowie Vervielfaeltigung dieses Dokuments, Verwertung
und Mitteilung seines Inhalts sind verboten, soweit nicht
The reproduction, distribution and utilization of this document as
well as the communication of its contents to others without express



			CAD! KEINE MANUELLEN AENDERUNGEN ! CAD! DONT CHANGE MANUAL	 Herrenknecht AG Schlehenweg 2 D-77963 Schwanau 2 Tel.: 07824 302-0 Fax.: 07824 3403 Info@Herrenknecht.de	Projekt: project: M-1642-C	Reserve reserve	Stueckliste: parts list: 25186184	Fg.-Gruppe: funct.-group: .23	Blatt-Nr.: page-nr.: 9	
Index Index	Aenderung-Nr. Change No.:	Datum / Name date / name	Ausdruck-Datum: printout-date: 14.12.11		=Container	Zn.-Nr.: drawn-nr.: 3478-562-002-.23	Datum: date: 26.08.2011	Bearb.: name: Th	letzte Aenderung: last modification: 14.12.11 Th	Blatt-Global: page-global: 135/166

Patent-, Gebrauchsmuster- oder Geschmacksmuster-Eintragung vorbehalten.
 of a patent, utility model or design.
 ausdrucklich gestattet. Zuwiderhandlungen verpflichten zu Schadenersatz. Alle Rechte fuer den Fall der Auhorisation is prohibited. Offenders will be held liable for the payment of damages. All rights reserved in the event of the grant
 Weitergabe sowie Vervielfaeltigung dieses Dokuments, Verwertung und Mitteilung seines Inhalts sind verboten, soweit nicht The reproduction, distribution and utilization of this document as well as the communication of its contents to others without express

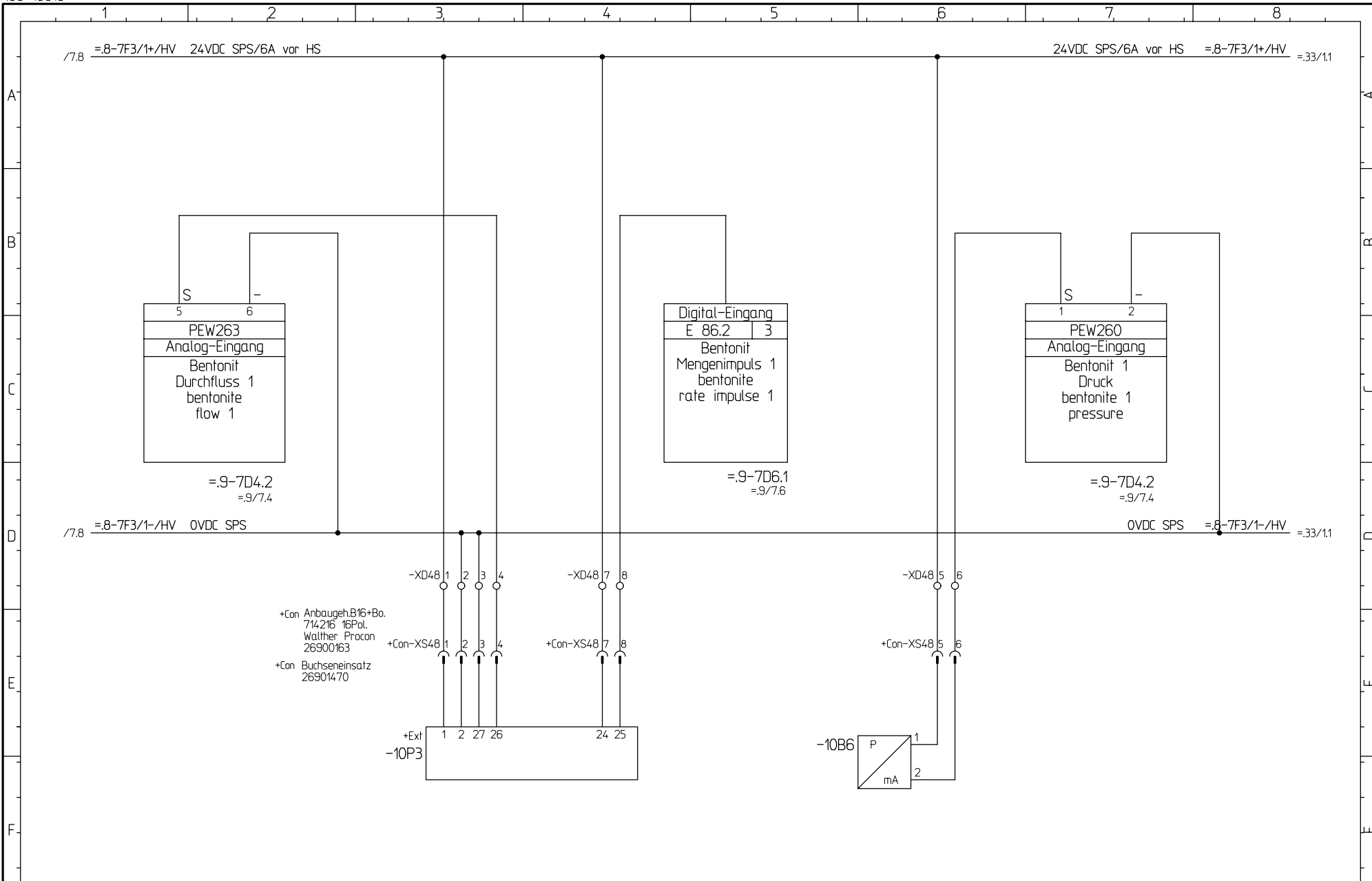

			CAD! KEINE MANUELLEN AENDERUNGEN! CAD! DONT CHANGE MANUAL		Herrenknecht AG Schlehenweg 2 D-77963 Schwanaau 2 Tel.: 07824 302-0 Fax.: 07824 3403 Info@Herrenknecht.de		Projekt: M-1642-C =Container		Bentonit Durchfluss/Druck System 1 bentonite flow/pressure system 1 Bentonitschmier. / bentonite lubrication		Stueckliste: parts list: 25186184		Fg.-Gruppe: funct.-group: .23		Blatt-Nr.: page-nr.: 10	
			Ausdruck-Datum: printout-date: 14.12.11				Zn.-Nr.: drawn-nr.: 3478-562-002-.23		Hauptverteilung main distribution board +HV/MDB		Datum: date: 26.08.2011		Bearb.: name: Th		letzte Aenderung: last modification: IB-Revision 14.12.11 Th	
Index Änderung-Nr. Datum / Name Index Change No. date / name													Blatt-Global: von page-global: 136/166 from			

Patent-, Gebrauchsmuster- oder Geschmacksmuster-Eintragung vorbehalten.
 of a patent, utility model or design.
 ausdrucklich gestattet. Zuwiderhandlungen verpflichten zu Schadenersatz. Alle Rechte fuer den Fall der Auhorisation ist prohibited. Offenders will be held liable for the payment of damages. All rights reserved in the event of the grant
 Weitergabe sowie Vervielfaeltigung dieses Dokuments, Verwertung und Mitteilung seines Inhalts sind verboten, soweit nicht The reproduction, distribution and utilization of this document as well as the communication of its contents to others without express

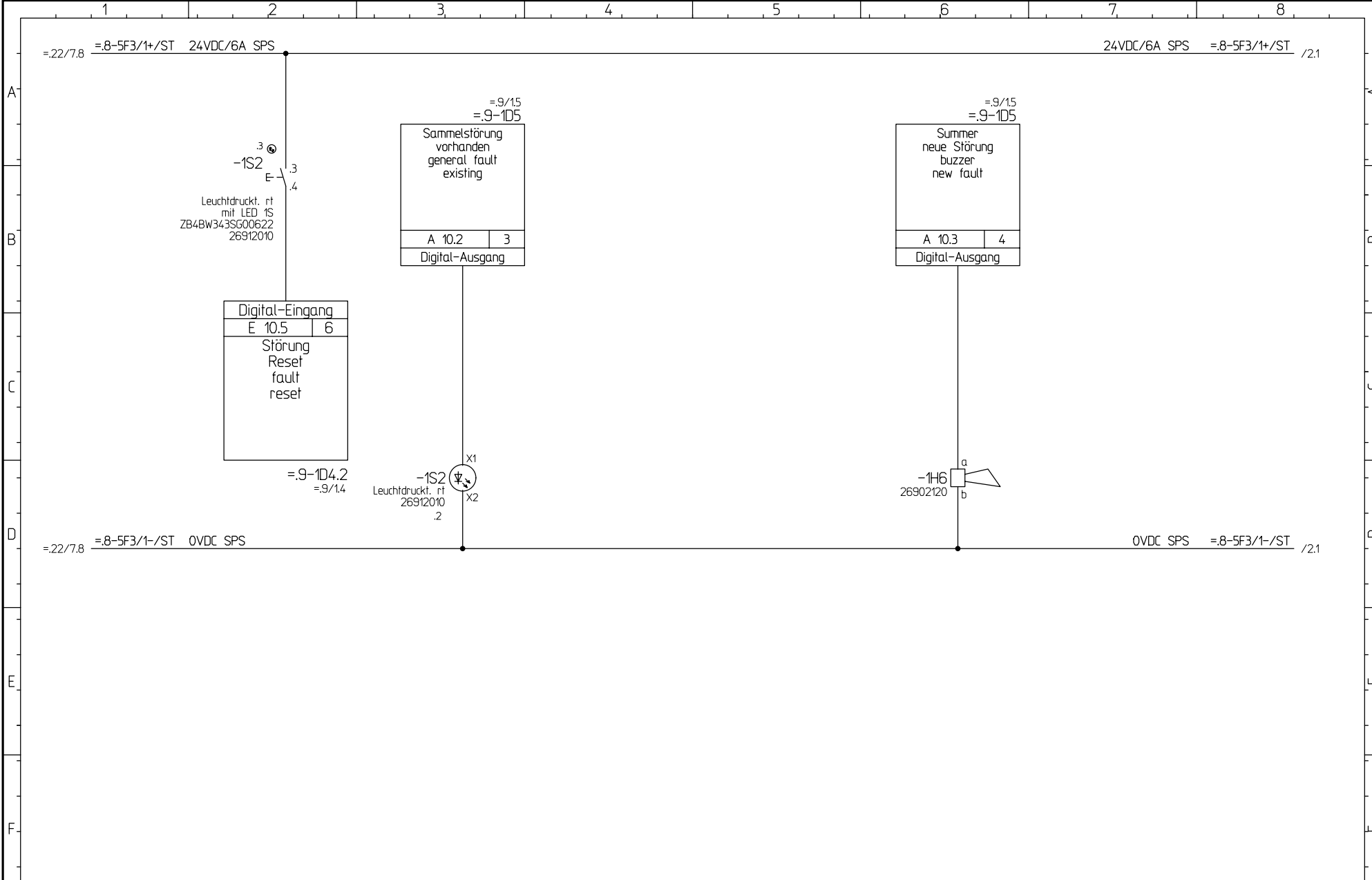



			CAD! KEINE MANUELLEN AENDERUNGEN! CAD! DONT CHANGE MANUAL		 Herrenknecht AG Schleheweg 2 D-77963 Schwanau 2 Tel.: 07824 302-0 Fax.: 07824 3403 Info@Herrenknecht.de	Projekt: M-1642-C =Container		Reset, Störung allgemein reset, general fault Sammelstörung / general fault		Stueckliste: parts list: 25186184		Fg.-Gruppe: funct.-group: .31		Blatt-Nr.: page-nr.: 1				
Ausdruck-Datum: printout-date: 14.12.11						Zn.-Nr.: drawn-nr.: 3478-562-002-31		Steuerstand Control Cabin +ST/CC		Datum: date: 26.08.2011		Bearb.: name: Th		letzte Aenderung: last modification: IB-Revision 14.12.11 Th		Blatt-Global: page-global: 137/166		von from 4

Patent-, Gebrauchsmuster- oder
 Geschmacksmuster-Eintragung vorbehalten.
 of a patent, utility model or design.

ausdrücklich gestattet. Zuwiderhandlungen verpflichten
 zu Schadensersatz. Alle Rechte fuer den Fall der
 authorization is prohibited. Offenders will be held liable for the
 payment of damages. All rights reserved in the event of the grant

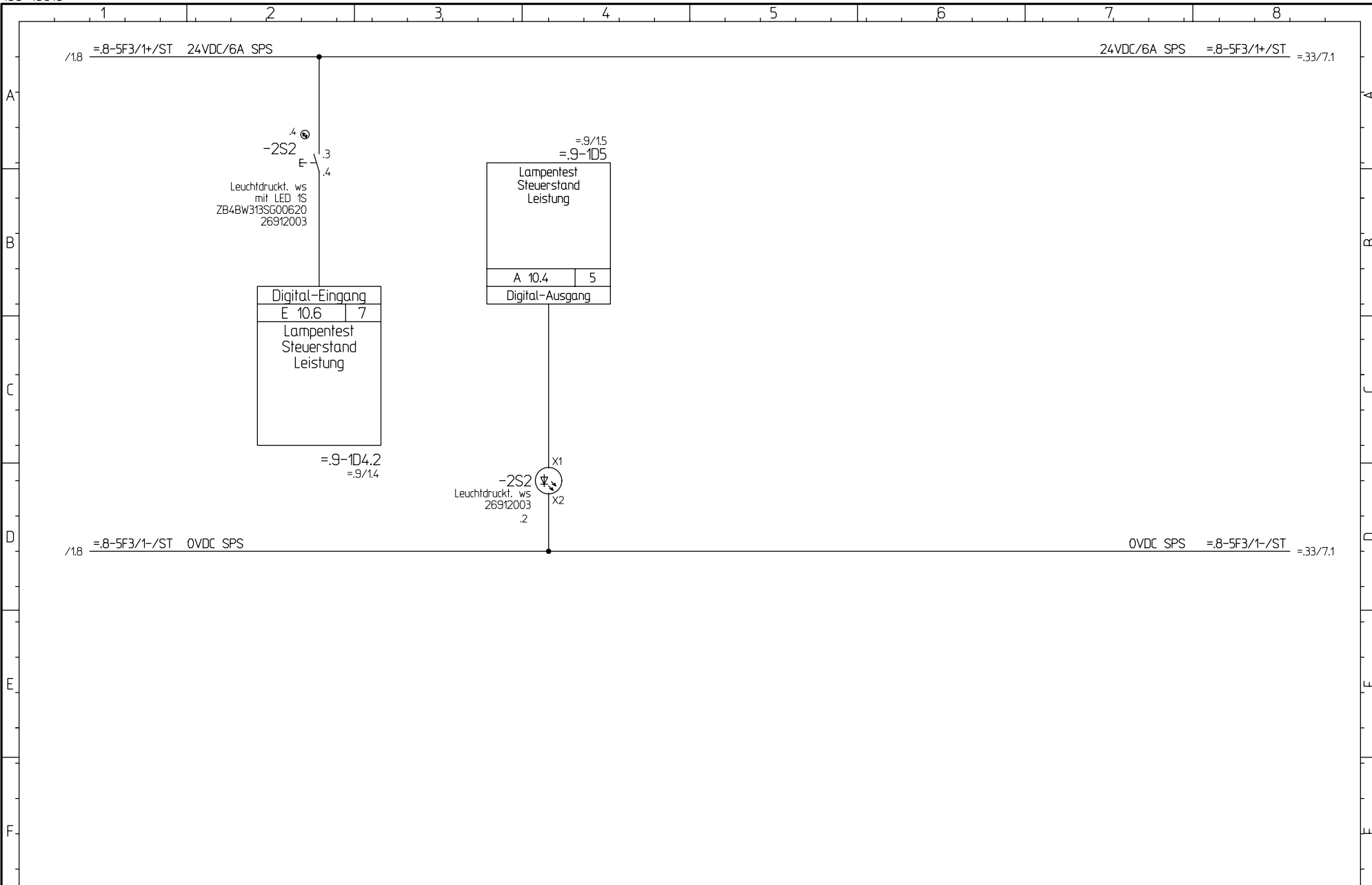
Weitergabe sowie Vervielfaeltigung dieses Dokuments, Verwertung
 und Mitteilung seines Inhalts sind verboten, soweit nicht
 The reproduction, distribution and utilization of this document as
 well as the communication of its contents to others without express



			CAD! KEINE MANUELLEN AENDERUNGEN! CAD! DONT CHANGE MANUAL		 Herrenknecht AG Schlehenweg 2 D-77963 Schwanau 2 Tel.: 07824 302-0 Fax.: 07824 3403 Info@Herrenknecht.de	Projekt: project: M-1642-C		Lampentest Steuerstand lamp check control cabin		Stueckliste: parts list: 25186184		Fg.-Gruppe: funct.-group: .31		Blatt-Nr.: page-nr.: 2	
			Ausdruck-Datum: printout-date: 14.12.11			=Container		Sammelstörung / general fault				Blatt-Global: page-global: 138/166		von from 4	
Index	Änderung-Nr. Change No.:	Datum / Name date / name				Zn.-Nr.:	3478-562-002-31	Steuerstand Control Cabin	Datum: date: 26.08.2011	Bearb.:	name: Th	letzte Änderung: last modification:	IB-Revision 14.12.11 Th		

Patent-, Gebrauchsmuster- oder Geschmacksmuster-Eintragung vorbehalten.
 of a patent, utility model or design.
 ausdrucklich gestattet. Zuwiderhandlungen verpflichten zu Schadenersatz. Alle Rechte fuer den Fall der authorisation is prohibited. Offenders will be held liable for the payment of damages. All rights reserved in the event of the grant
 Weitergabe sowie Vervielfaeltigung dieses Dokuments, Verwertung und Mitteilung seines Inhalts sind verboten, soweit nicht The reproduction, distribution and utilization of this document as well as the communication of its contents to others without express

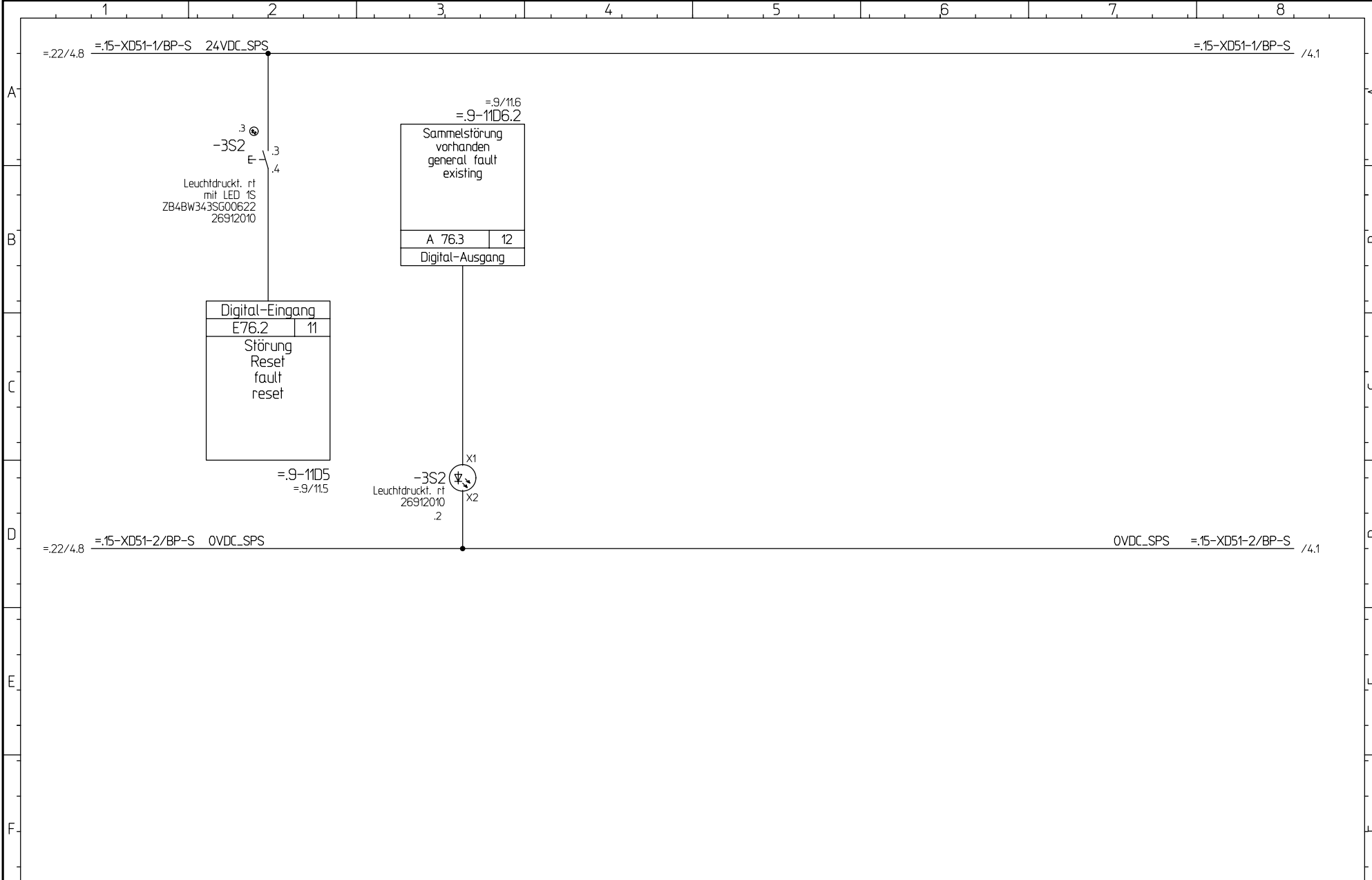

			CAD! KEINE MANUELLEN AENDERUNGEN! CAD! DONT CHANGE MANUAL		 Herrenknecht AG Schleenweg 2 D-77963 Schwanau 2 Tel.: 07824 302-0 Fax.: 07824 3403 Info@Herrenknecht.de		Projekt: M-1642-C project: =Container		Sammelstörung vorhanden general fault existing Sammelstörung / general fault		Stueckliste: parts list: 25186184		Fg.-Gruppe: funct.-group: .31		Blatt-Nr.: page-nr.: 3			
			Ausdruck-Datum: printout-date: 14.12.11				Zn.-Nr.: drawn-nr.: 3478-562-002-31		Bedienpult Schacht control panel shaft +BP/CP-S		Datum: date: 26.08.2011		Bearb. name: Th		letzte Aenderung: last modification: IB-Revision 14.12.11 Th		Blatt-Global: page-global: 139/166	

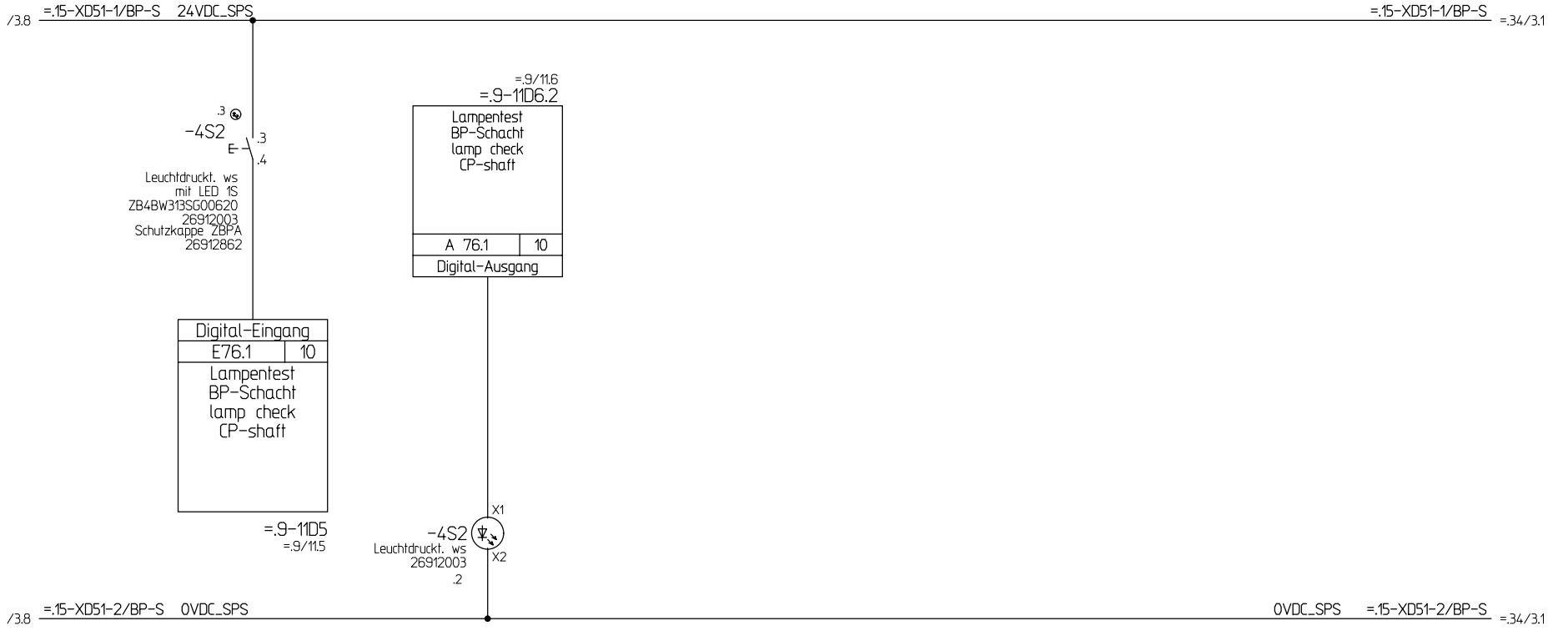

Patent-, Gebrauchsmuster- oder Geschmacksmuster-Eintragung vorbehalten. of a patent, utility model or design.

ausdrücklich gestattet. Zuwiderhandlungen verpflichten zu Schadenersatz. Alle Rechte fuer den Fall der authorisation is prohibited. Offenders will be held liable for the payment of damages. All rights reserved in the event of the grant

Weitergabe sowie Vervielfaeltigung dieses Dokuments, Verwertung und Mitteilung seines Inhalts sind verboten, soweit nicht The reproduction, distribution and utilization of this document as well as the communication of its contents to others without express

			CAD! KEINE MANUELLEN AENDERUNGEN ! CAD! DONT CHANGE MANUAL		Herrenknecht AG Schlehenweg 2 D-77963 Schwanau 2 Tel.: 07824 302-0 Fax.: 07824 3403 Info@Herrenknecht.de		Projekt: M-1642-C =Container		Lampentest BP-Schacht lamp check CP-shaft Sammelstörung / general fault		Stueckliste: parts list: 25186184		Fg.-Gruppe: funct.-group: .31		Blatt-Nr.: page-nr.: 4	
			Ausdruck-Datum: printout-date: 14.12.11				Zn.-Nr.: drawn-nr.: 3478-562-002-31		Bedienpult Schacht control panel shaft +BP/CP-S		Datum: date: 26.08.2011		Bearb.: name: Th		letzte Aenderung: last modification: IB-Revision 14.12.11 Th	
Index Index			Änderung-Nr. Change No.:												Blatt-Global: page-global: 140/166	

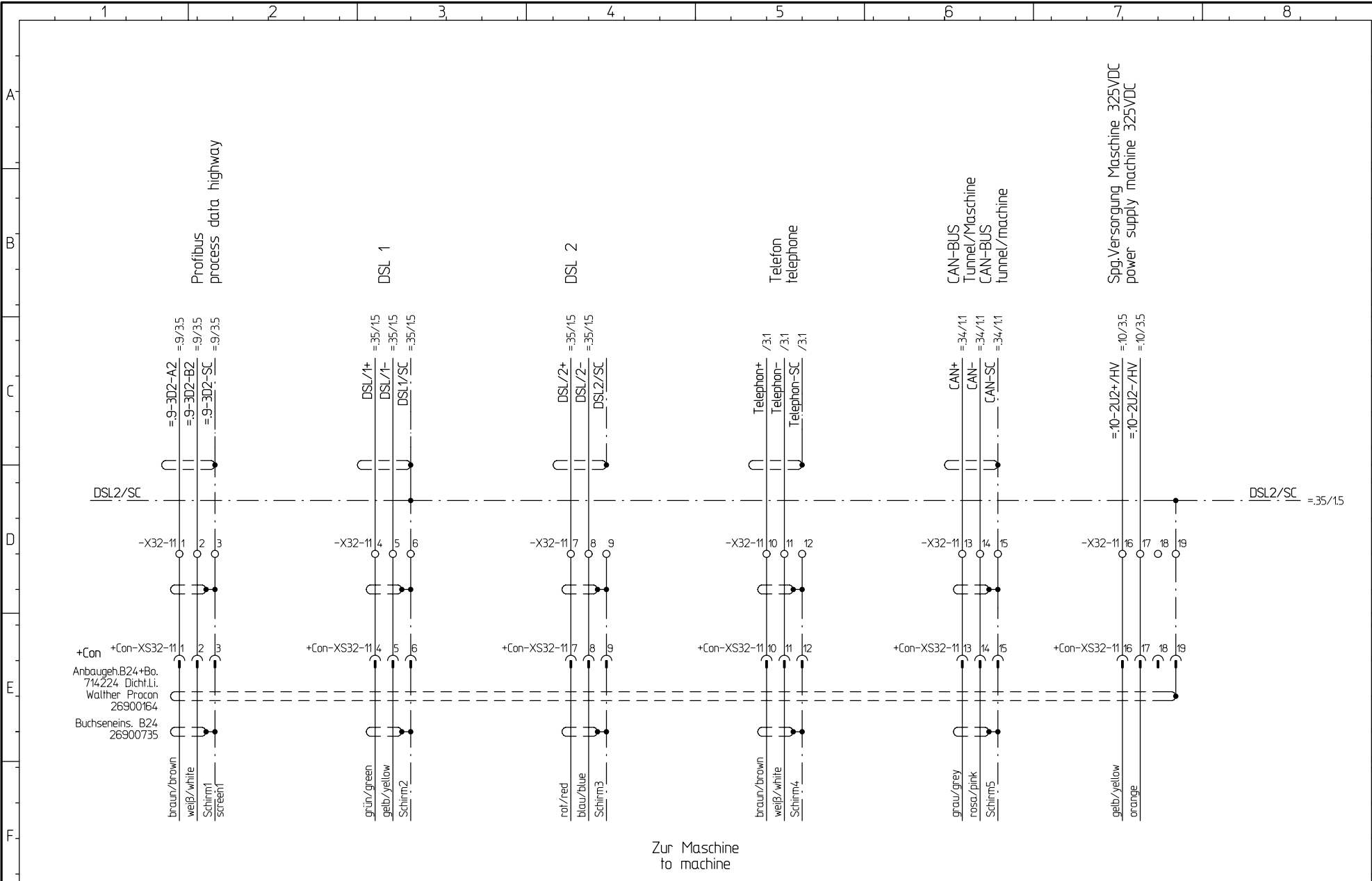

Index	Änderung-Nr. Change No.:	Datum / Name date / name
Index		

CAD! KEINE MANUELLEN
ÄNDERUNGEN!
CAD!
DON'T CHANGE MANUAL

Ausdruck-Datum:
printout-date:
14.12.11



Herrenknecht AG
Schlehenweg 2
D-77963 Schwanau 2
Tel.: 07824 302-0
Fax.: 07824 3403
Info@Herrenknecht.de

Projekt: project:	M-1642-C
Zn.-Nr.: drawn-nr.:	3478-562-002-.32

Datenverbindung zu Maschine data connection to machine	
Tunnel Kommunik. / tunnel communication	
Hauptverteilung main distribution board	Datum: date:
+HV/MBB	26.08.2011
Bearb. name:	Th

Stueckliste: parts list:	Fg.-Gruppe: funct.-group:	Blatt-Nr.: page-nr.:
25186184	.32	1
letzte Aenderung: last modification:	Blatt-Global: page-global:	von from
1B-Revision 14.12.11 Th	141/166	4

Patent-, Gebrauchsmuster- oder Geschmacksmuster-Eintragung vorbehalten.
 of a patent, utility model or design.
 ausdrucklich gestattet. Zuwiderhandlungen verpflichten zu Schadenersatz. Alle Rechte fuer den Fall der Auhorisation is prohibited. Offenders will be held liable for the payment of damages. All rights reserved in the event of the grant
 Weitergabe sowie Vervielfaeltigung dieses Dokuments, Verwertung und Mitteilung seines Inhalts sind verboten, soweit nicht The reproduction, distribution and utilization of this document as well as the communication of its contents to others without express

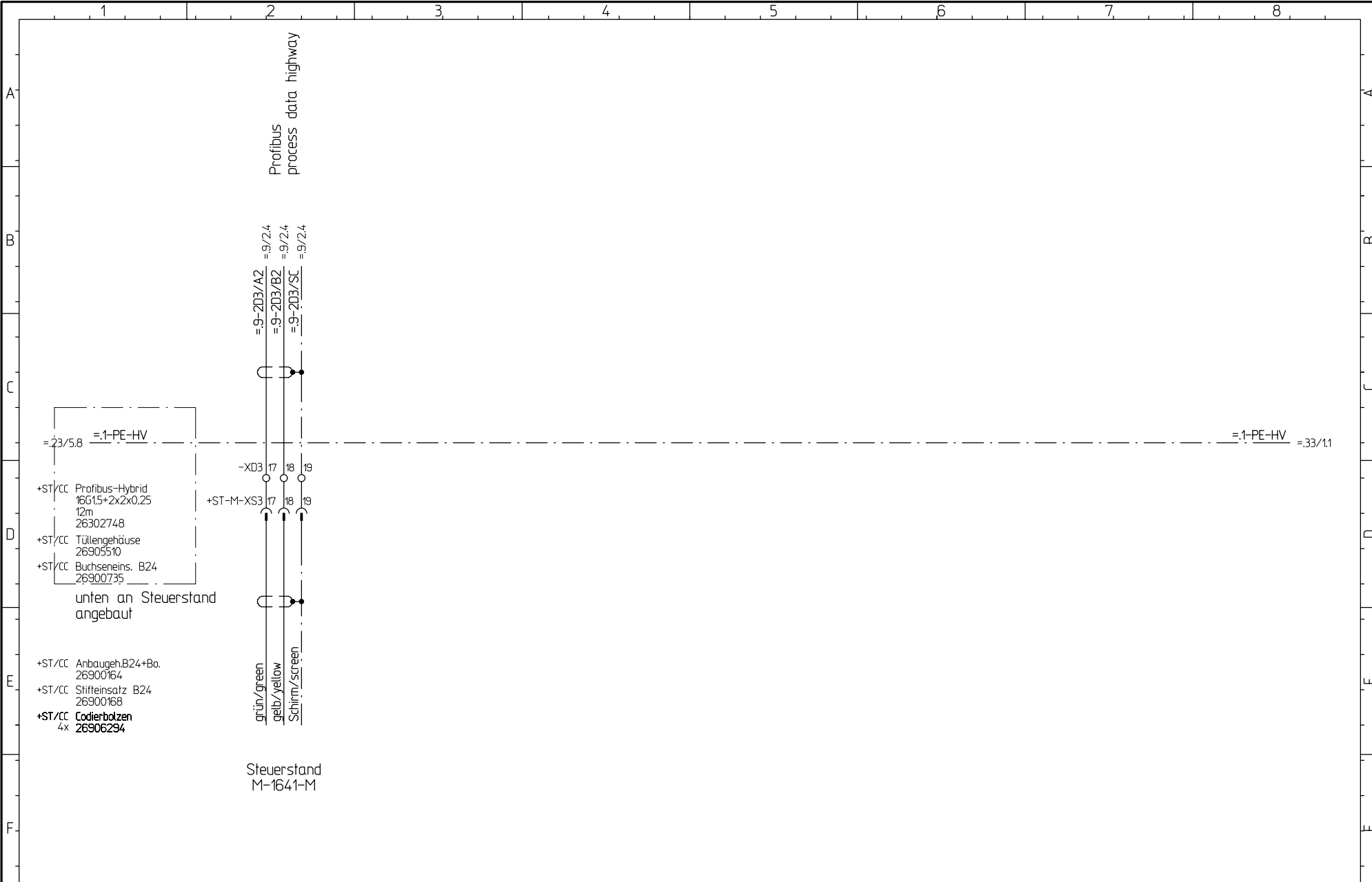



			CAD! KEINE MANUELLEN AENDERUNGEN! CAD! DONT CHANGE MANUAL		Herrenknecht AG Schlehenweg 2 D-77963 Schwanaue 2 Tel.: 07824 302-0 Fax.: 07824 3403 Info@Herrenknecht.de		Projekt: M-1642-C =Container		Datenverbindung ST<=>HV Tunnel Kommunik. / tunnel communication		Stueckliste: parts list: 25186184	Fg.-Gruppe: funct.-group: .32	Blatt-Nr.: page-nr.: 2	
			Ausdruck-Datum: printout-date: 14.12.11				Zn.-Nr.: drawn-nr.: 3478-562-002-.32		Hauptverteilung main distribution board +HV/ MDB	Datum: date: 26.08.2011	Bearb.: name: Th	letzte Aenderung: last modification: 14.12.11 Th	Blatt-Global: page-global: 142/166	von from 4

Patent-, Gebrauchsmuster- oder Geschmacksmuster-Eintragung vorbehalten. of a patent, utility model or design.

ausdruecklich gestattet. Zuwiderhandlungen verpflichten zu Schadenersatz. Alle Rechte fuer den Fall der authorisation is prohibited. Offenders will be held liable for the payment of damages. All rights reserved in the event of the grant

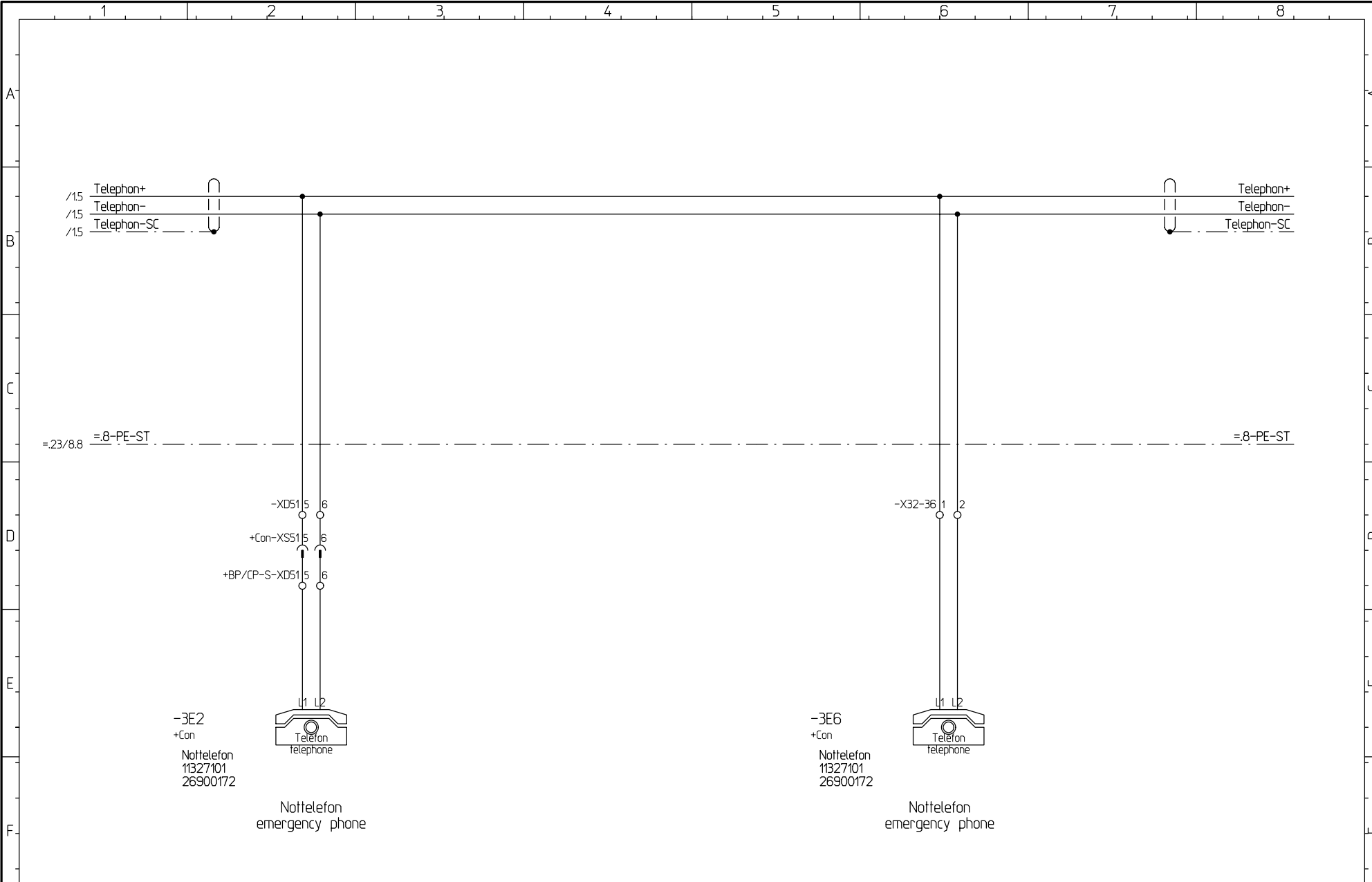
Weitergabe sowie Vervielfaerung dieses Dokuments, Verwertung und Mitteilung seines Inhalts sind verboten, soweit nicht The reproduction, distribution and utilization of this document as well as the communication of its contents to others without express





			CAD! KEINE MANUELLEN AENDERUNGEN! CAD! DONT CHANGE MANUAL	 Herrenknecht AG Schlehenweg 2 D-77963 Schwanau 2 Tel.: 07824 302-0 Fax.: 07824 3403 Info@Herrenknecht.de	Projekt: project: M-1642-C	Telefon Container phones container	Stueckliste: parts list: 25186184	Fg.-Gruppe: funct.-group: .32	Blatt-Nr.: page-nr.: 3		
Index Index	Aenderung-Nr. Change No.:	Datum / Name date / name	Ausdruck-Datum: printout-date: 14.12.11		=Container	Tunnel Kommunik. / tunnel communication	Hauptverteilung main distribution board +HV/MDB	Datum: date: 26.08.2011	Bearb.: name: Th	letzte Aenderung: last modification: 14.12.11 Th	Blatt-Global: page-global: 143/166

Patent-, Gebrauchsmuster- oder
Geschmacksmuster-Eintragung vorbehalten.
of a patent, utility model or design.

ausdrücklich gestattet. Zuwiderhandlungen verpflichten
zu Schadenersatz. Alle Rechte fuer den Fall der
Auhorisation is prohibited. Offenders will be held liable for the
payment of damages. All rights reserved in the event of the grant

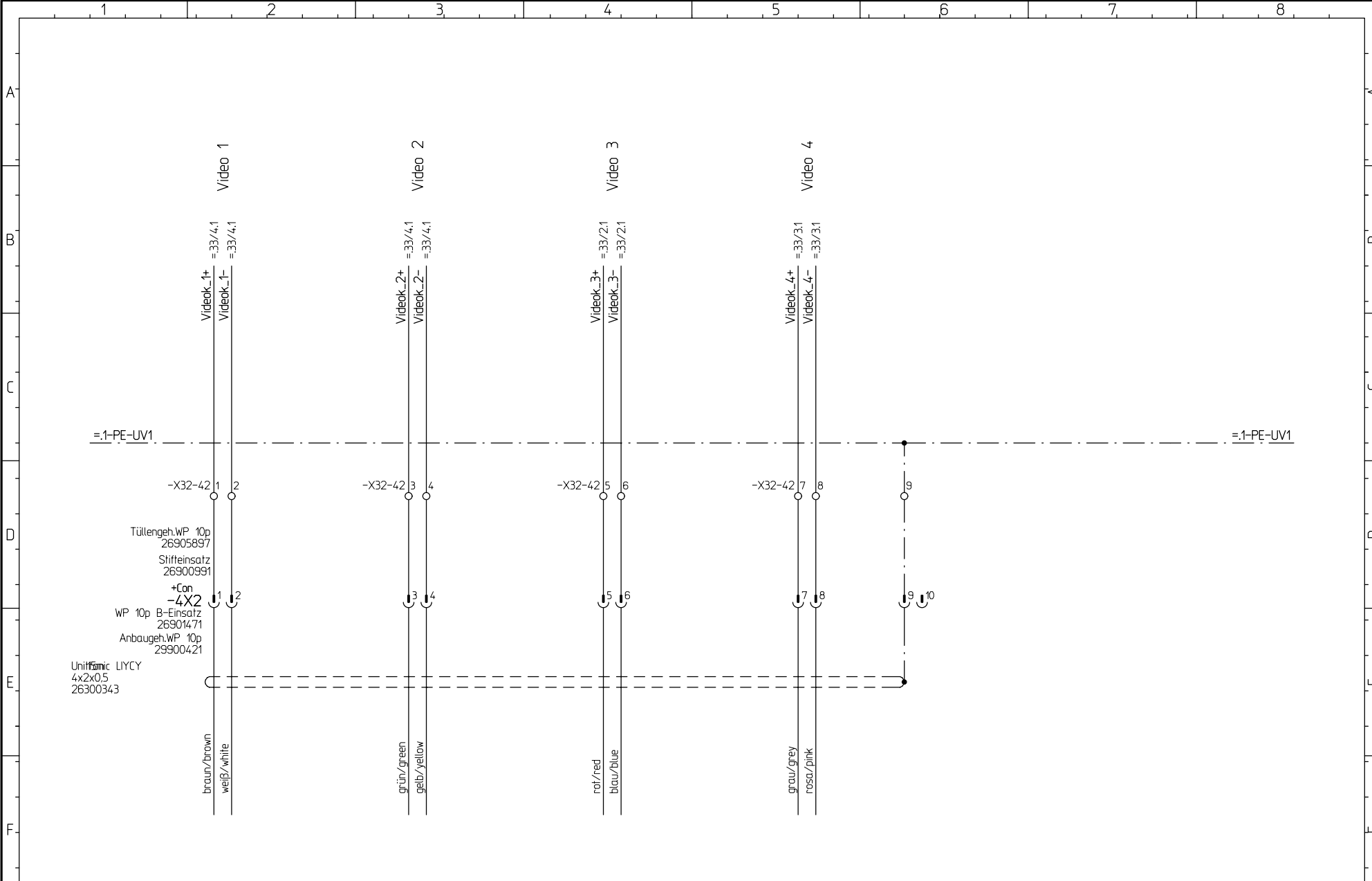
Weitergabe sowie Vervielfaeltigung dieses Dokuments, Verwertung
und Mitteilung seines Inhalts sind verboten, soweit nicht
The reproduction, distribution and utilization of this document as
well as the communication of its contents to others without express





			CAD! KEINE MANUELLEN AENDERUNGEN! CAD! DONT CHANGE MANUAL		Projekt: project: M-1642-C		Kommunikations-Schnittstelle zu Cont. Tunnel Kommunik. / tunnel communication		Stueckliste: parts list: 25186184		Fg.-Gruppe: funct.-group: .32		Blatt-Nr.: page-nr.: 4	
			Ausdruck-Datum: printout-date: 14.12.11		=Container						Blatt-Global: page-global: 144/166		von from 4	
Index	Aenderung-Nr. Change No.:	Datum / Name date / name	 Herrenknecht AG Schlehenweg 2 D-77963 Schwanau 2 Tel.: 07824 302-0 Fax.: 07824 3403 Info@Herrenknecht.de		Zn.-Nr. drawn-nr.: 3478-562-002-.32	Hauptverteilung main distribution board +HV/MBB		Datum: date: 26.08.2011	Bearb. name: Th	letzte Aenderung: last modification: 14.12.11 Th				

Patent-, Gebrauchsmuster- oder
 Geschmacksmuster-Eintragung vorbehalten.
 of a patent, utility model or design.

ausdrücklich gestattet. Zuwiderhandlungen verpflichten
 zu Schadenersatz. Alle Rechte fuer den Fall der
 authorization is prohibited. Offenders will be held liable for the
 payment of damages. All rights reserved in the event of the grant

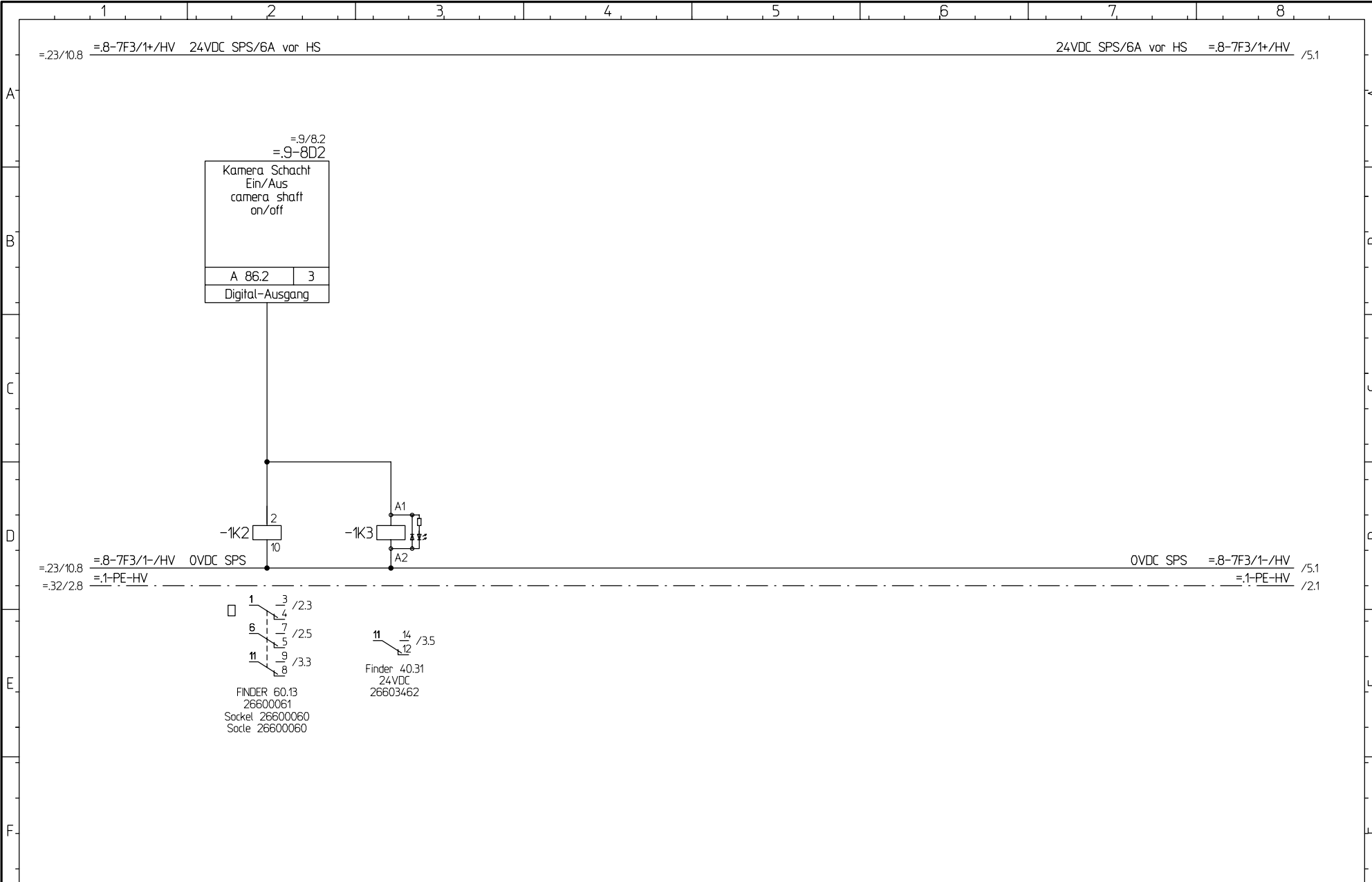
Weitergabe sowie Vervielfaeltigung dieses Dokuments, Verwertung
 und Mitteilung seines Inhalts sind verboten, soweit nicht
 The reproduction, distribution and utilization of this document as
 well as the communication of its contents to others without express



			CAD! KEINE MANUELLEN AENDERUNGEN! CAD! DONT CHANGE MANUAL		 Herrenknecht AG Schlehenweg 2 D-77963 Schwanaeu 2 Tel.: 07824 302-0 Fax.: 07824 3403 Info@Herrenknecht.de		Projekt: M-1642-C Kamera Maschine camera machine Videoüberwachung / video controlling		Stueckliste: parts list: 25186184		Fg.-Gruppe: funct.-group: .33		Blatt-Nr.: page-nr.: 1	
			Ausdruck-Datum: printout-date: 14.12.11				=Container		Hauptverteilung main distribution board +HV/MDB		Datum: date: 26.08.2011		Bearb.: name: Th	
Index	Aenderung-Nr. Change No.:	Datum / Name date / name				Zn.-Nr. drawn-nr.:	3478-562-002-.33				Blatt-Global: page-global: 145/166		von from 12	

Patent-, Gebrauchsmuster- oder Geschmacksmuster-Eintragung vorbehalten. of a patent, utility model or design.
 ausdrucklich gestattet. Zuwiderhandlungen verpflichten zu Schadenersatz. Alle Rechte fuer den Fall der authorisation is prohibited. Offenders will be held liable for the payment of damages. All rights reserved in the event of the grant
 Weitergabe sowie Vervielfaeltigung dieses Dokuments, Verwertung und Mitteilung seines Inhalts sind verboten, soweit nicht The reproduction, distribution and utilization of this document as well as the communication of its contents to others without express

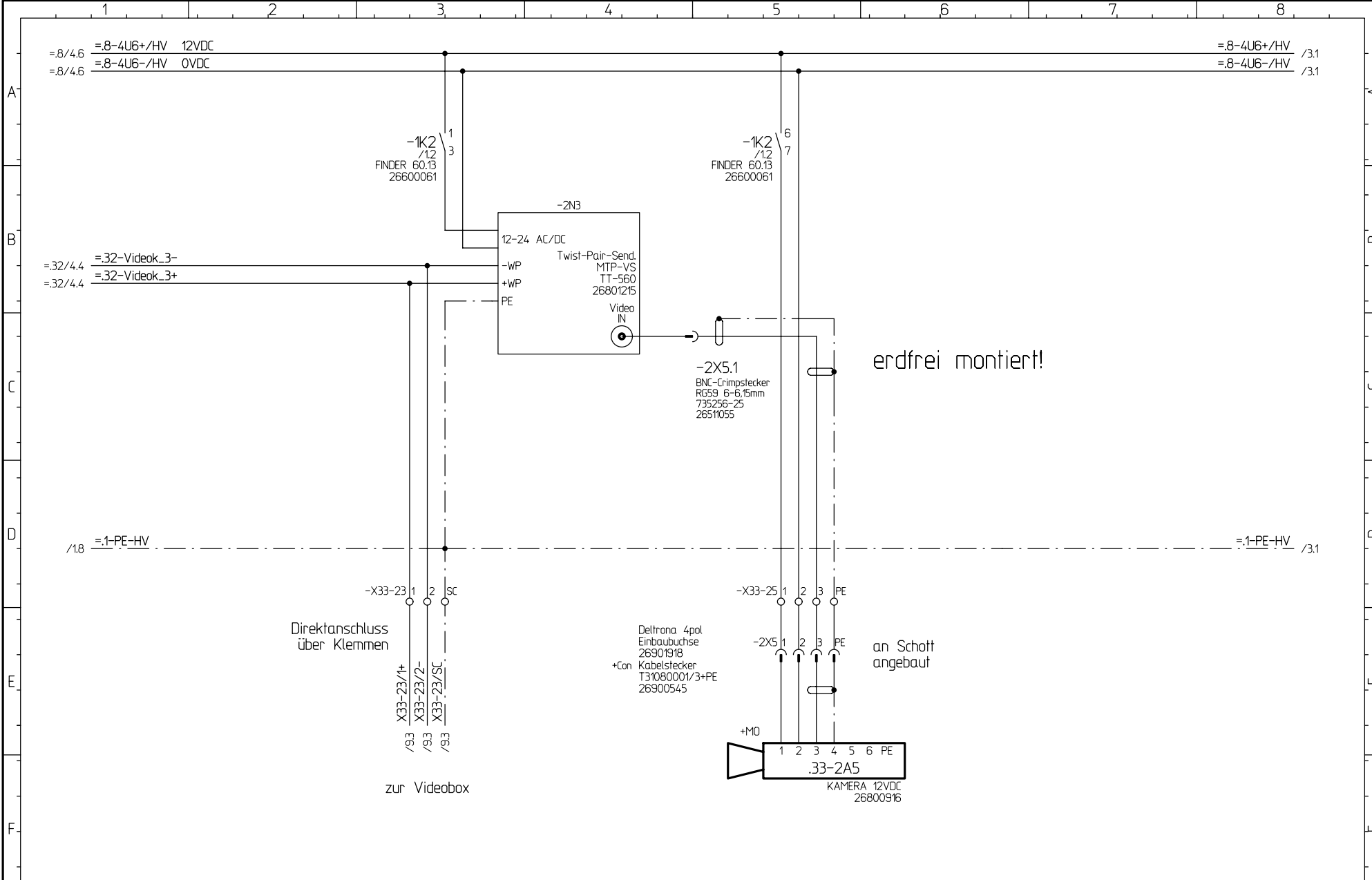

			CAD! KEINE MANUELLEN AENDERUNGEN! CAD! DONT CHANGE MANUAL		Herrenknecht AG Schlehenweg 2 D-77963 Schwanau 2 Tel.: 07824 302-0 Fax.: 07824 3403 Info@Herrenknecht.de		Projekt: M-1642-C =Container		Videokamera 3 Schacht unten Videoüberwachung / video controlling		Stueckliste: parts list: 25186184		Fg.-Gruppe: funct.-group: .33		Blatt-Nr.: page-nr.: 2	
			Ausdruck-Datum: printout-date: 14.12.11				Zn.-Nr.: drawn-nr.: 3478-562-002-.33		Hauptverteilung main distribution board +HV/MDB		Datum: date: 26.08.2011		Bearb.: name: Th		letzte Aenderung: last modification: IB-Revision 14.12.11 Th	
Index Änderung-Nr. Datum / Name Index Change No. date / name													Blatt-Global: von page-global: 146/166 from			

Patent-, Gebrauchsmuster- oder Geschmacksmuster-Eintragung vorbehalten. of a patent, utility model or design.
 Ausdrucklich gestattet. Zuwiderhandlungen verpflichten zu Schadensersatz. Alle Rechte fuer den Fall der authorisation is prohibited. Offenders will be held liable for the payment of damages. All rights reserved in the event of the grant
 Weitergabe sowie Vervielfaeltigung dieses Dokuments, Verwertung und Mitteilung seines Inhalts sind verboten, soweit nicht The reproduction, distribution and utilization of this document as well as the communication of its contents to others without express

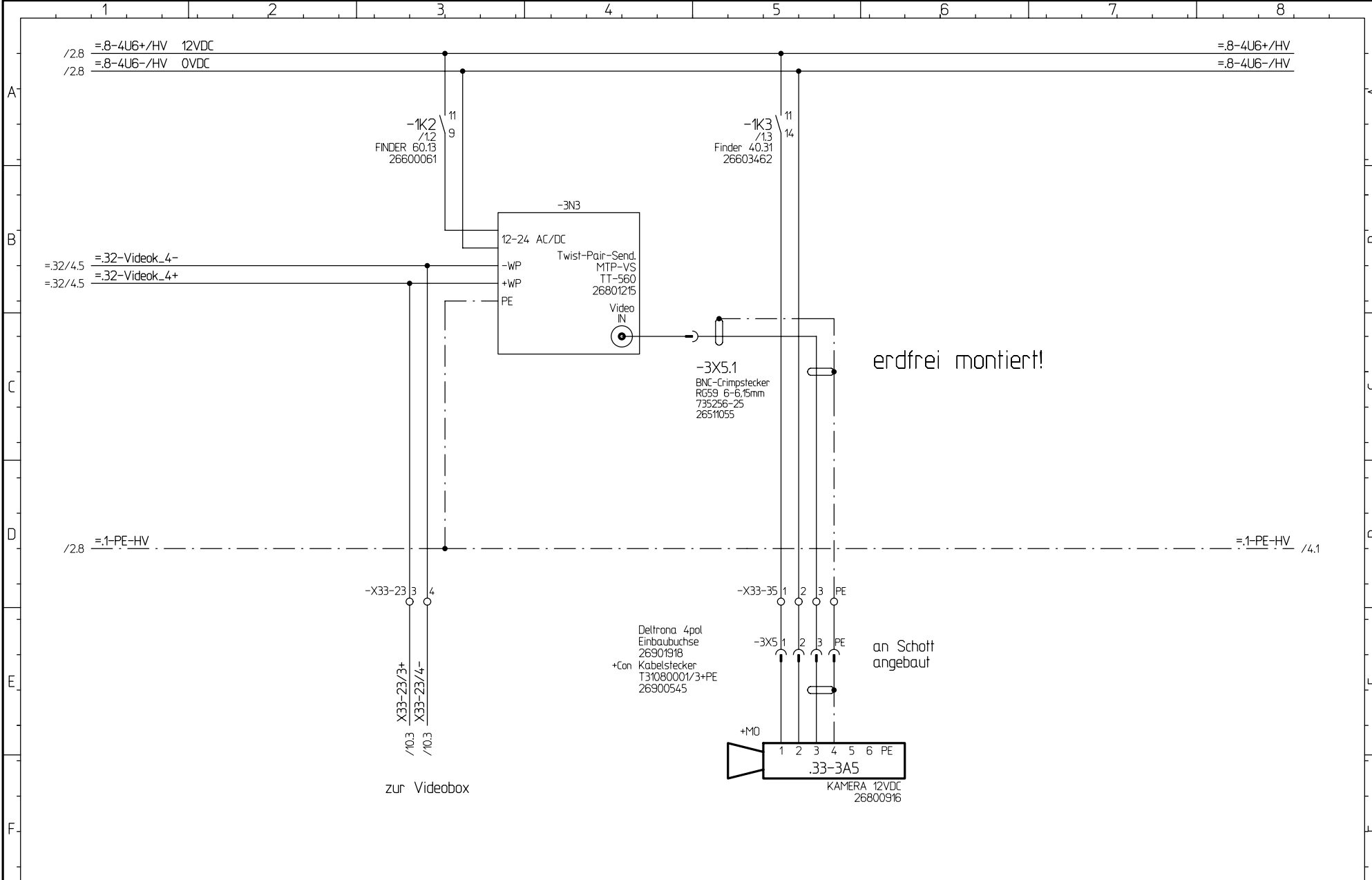



			CAD! KEINE MANUELLEN AENDERUNGEN! CAD! DONT CHANGE MANUAL	 Herrenknecht AG Schleenweg 2 D-77963 Schwanau 2 Tel.: 07824 302-0 Fax.: 07824 3403 Info@Herrenknecht.de	Projekt: project: M-1642-C	Videokamera 4 Schacht oben		Stueckliste: parts list: 25186184	Fg.-Gruppe: funct.-group: .33	Blatt-Nr.: page-nr.: 3
Index Index	Aenderung-Nr. Change No.:	Datum / Name date / name	Ausdruck-Datum: printout-date: 14.12.11		Zn.-Nr.: drawn-nr.: 3478-562-002-.33	Videouberwachung / video controlling		Hauptverteilung main distribution board +HV/MDB	Datum: date: 26.08.2011	Bearb.: name: Th

Patent-, Gebrauchsmuster- oder Geschmacksmuster-Eintragung vorbehalten.
of a patent, utility model or design.

ausdrücklich gestattet. Zuwiderhandlungen verpflichten zu Schadensersatz. Alle Rechte fuer den Fall der Autorisation ist prohibited. Offenders will be held liable for the payment of damages. All rights reserved in the event of the grant

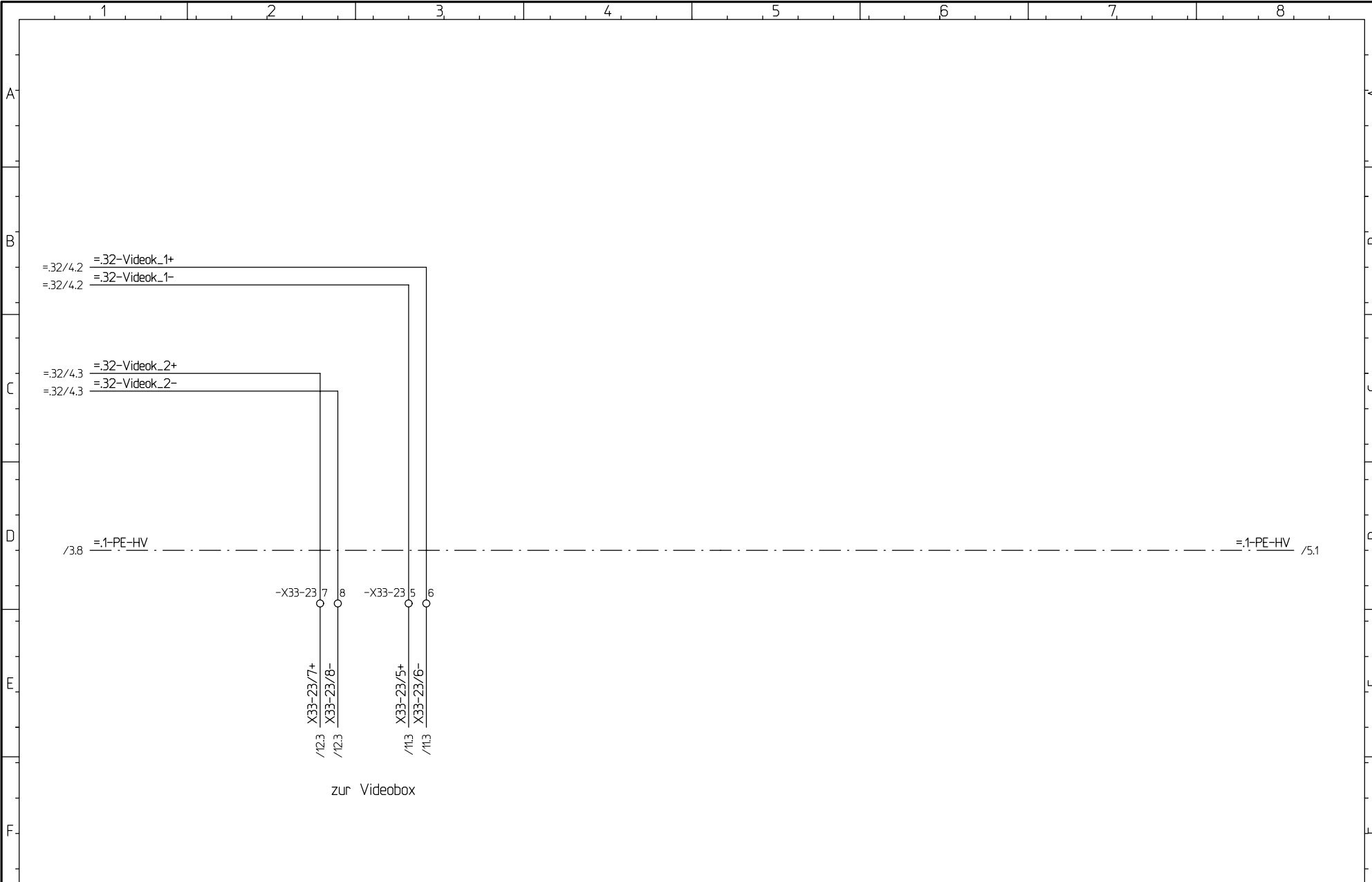
Weitergabe sowie Vervielfaeltigung dieses Dokuments, Verwertung und Mitteilung seines Inhalts sind verboten, soweit nicht The reproduction, distribution and utilization of this document as well as the communication of its contents to others without express



			CAD! KEINE MANUELLEN AENDERUNGEN! CAD! DONT CHANGE MANUAL		 Herrenknecht AG Schlehenweg 2 D-77963 Schwanaau 2 Tel.: 07824 302-0 Fax.: 07824 3403 Info@Herrenknecht.de	Projekt: M-1642-C =Container		Verbindung zu Empfänger/Monitor Quad Videouberwachung / video controlling		Stueckliste: 25186184 Fg.-Gruppe: .33 Blatt-Nr.: 4	
Index Index	Änderung-Nr. Change No.:	Datum / Name date / name	Ausdruck-Datum: printout-date: 14.12.11			Zn.-Nr.: drawn-nr.: 3478-562-002-.33	Hauptverteilung main distribution board +HV/ MDB	Datum: date: 26.08.2011	Bearb.: name: Th	letzte Aenderung: last modification: IB-Revision 14.12.11 Th	

Patent-, Gebrauchsmuster- oder Geschmacksmuster-Eintragung vorbehalten.
 of a patent, utility model or design.
 ausdrucklich gestattet. Zuwiderhandlungen verpflichten zu Schadenersatz. Alle Rechte fuer den Fall der authorization is prohibited. Offenders will be held liable for the payment of damages. All rights reserved in the event of the grant
 Weitergabe sowie Vervielfaeltigung dieses Dokuments, Verwertung und Mitteilung seines Inhalts sind verboten, soweit nicht The reproduction, distribution and utilization of this document as well as the communication of its contents to others without express

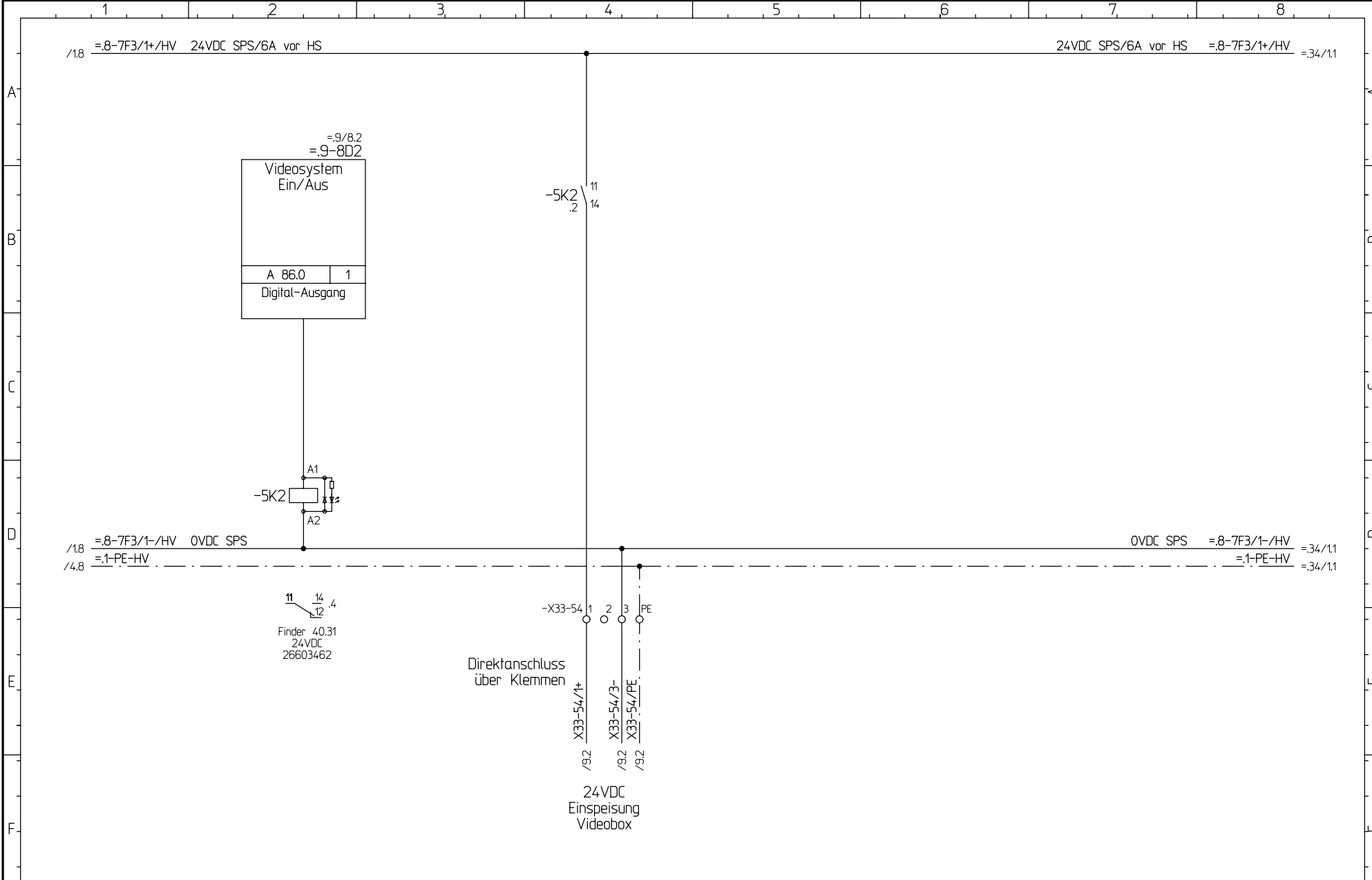



			CAD! KEINE MANUELLEN AENDERUNGEN! CAD! DONT CHANGE MANUAL		 Herrenknecht AG Schleheweg 2 D-77963 Schwanau 2 Tel.: 07824 302-0 Fax.: 07824 3403 Info@Herrenknecht.de	Projekt: M-1642-C =Container		Videosystem Ein/Aus Videoüberwachung / video controlling		Stueckliste: 25186184 parts list:		Fg.-Gruppe: .33 funct.-group:		Blatt-Nr.: 5 page-nr.:				
Ausdruck-Datum: 14.12.11 printout-date:						Zn.-Nr.: 3478-562-002-.33 drawn-nr.:		Hauptverteilung main distribution board +HV/MDB		Datum: 26.08.2011 date:		Bearb.: Th name:		letzte Aenderung: 14.12.11 Th last modification:		Blatt-Global: 149/166 page-global:		von: from 12

Patent-, Gebrauchsmuster- oder
Geschmacksmuster-Eintragung vorbehalten.
of a patent, utility model or design.

ausdrücklich gestattet. Zuwiderhandlungen verpflichten
zu Schadensersatz. Alle Rechte fuer den Fall der
Auhorisation is prohibited. Offenders will be held liable for the
payment of damages. All rights reserved in the event of the grant

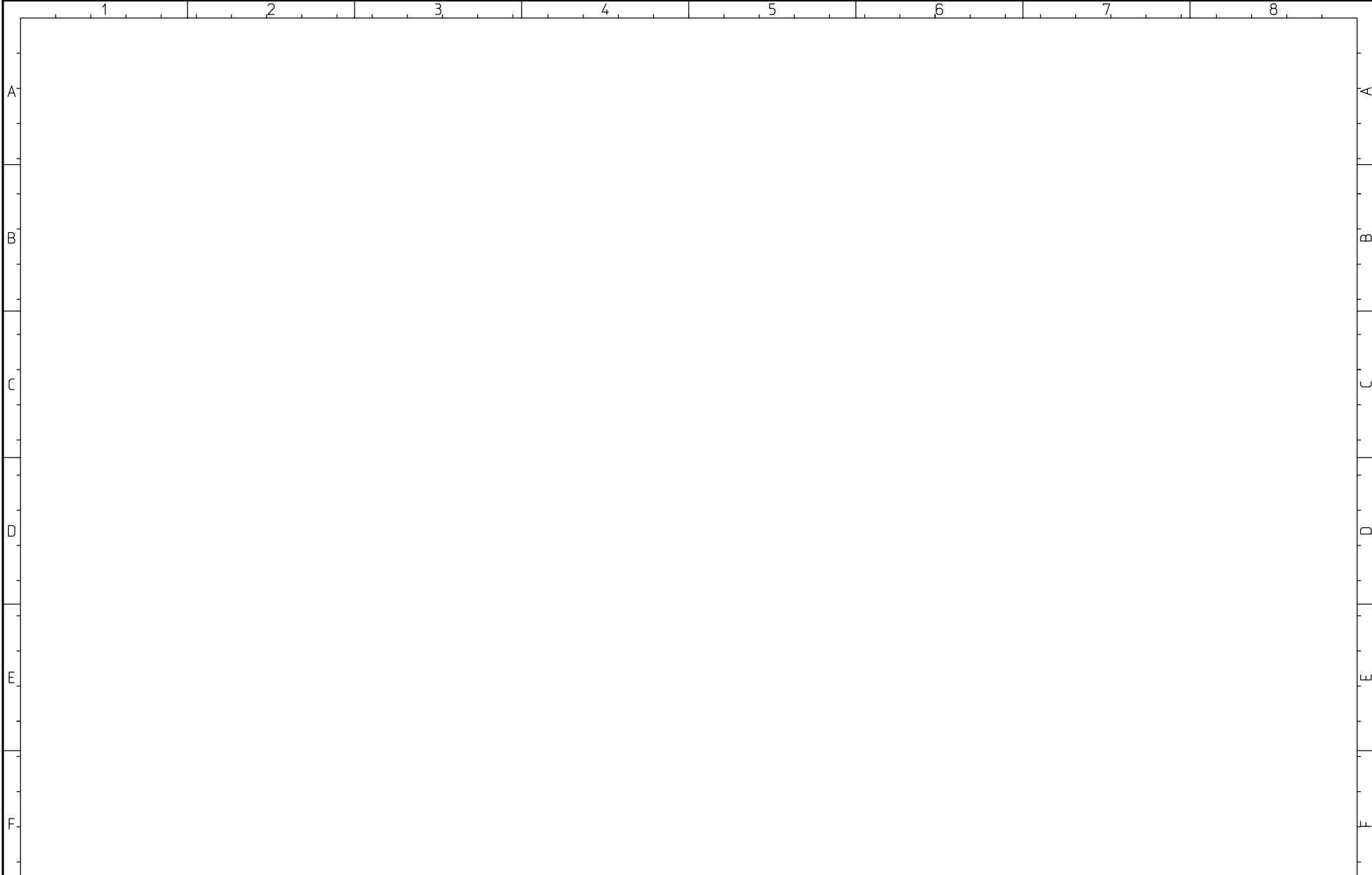
Weitergabe sowie Vervielfaeltigung dieses Dokuments, Verwertung
und Mitteilung seines Inhalts sind verboten, soweit nicht
The reproduction, distribution and utilization of this document as
well as the communication of its contents to others without express





			CAD! KEINE MANUELLEN AENDERUNGEN ! CAD! DONT CHANGE MANUAL	 Herrenknecht AG Schlehenweg 2 D-77963 Schwanau 2 Tel.: 07824 302-0 Fax.: 07824 3403 Info@Herrenknecht.de	Projekt: project: M-1642-C	Reserve reserve	Stueckliste: parts list: 25186184	Fg.-Gruppe: funct.-group: .33	Blatt-Nr.: page-nr.: 6
Index Index	Aenderung-Nr. Change No.:	Datum / Name date / name	Ausdruck-Datum: printout-date: 14.12.11		=Container	Videouberwachung / video controlling			Blatt-Global: page-global: 150/166
					Zn.-Nr.: drawn-nr.: 3478-562-002-.33	Datum: date: 26.08.2011	Bearb.: name: Th	letzte Aenderung: last modification: 14.12.11 Th	

Patent-, Gebrauchsmuster- oder Geschmacksmuster-Eintragung vorbehalten. of a patent, utility model or design.

ausdrücklich gestattet. Zuwiderhandlungen verpflichten zu Schadenersatz. Alle Rechte fuer den Fall der authorisation is prohibited. Offenders will be held liable for the payment of damages. All rights reserved in the event of the grant

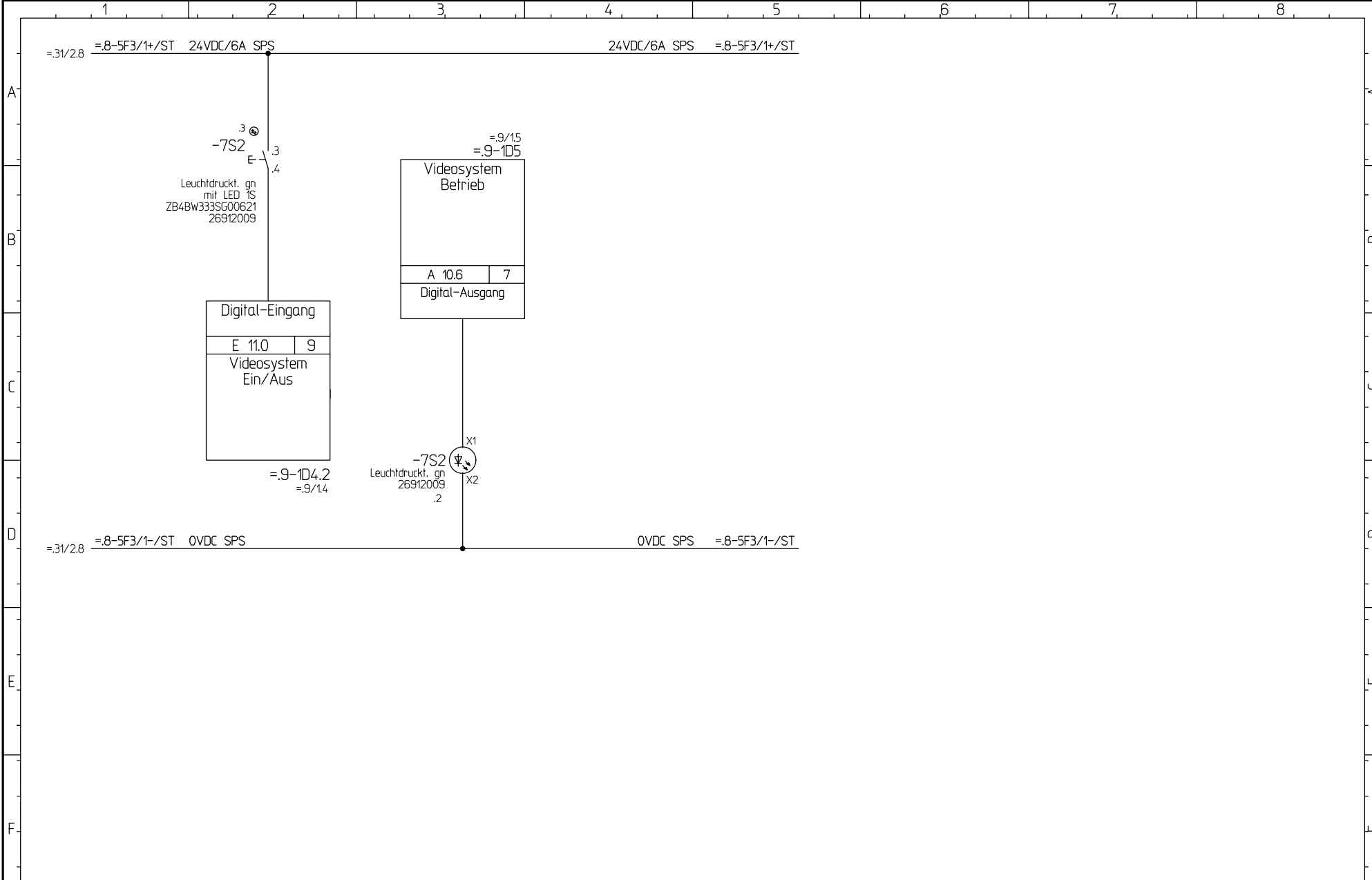
Weitergabe sowie Vervielfaeltigung dieses Dokuments, Verwertung und Mitteilung seines Inhalts sind verboten, soweit nicht The reproduction, distribution and utilization of this document as well as the communication of its contents to others without express





			CAD! KEINE MANUELLEN AENDERUNGEN ! CAD! DONT CHANGE MANUAL		Herrenknecht AG Schlehenweg 2 D-77963 Schwanaau 2 Tel.: 07824 302-0 Fax.: 07824 3403 Info@Herrenknecht.de		Projekt: project: M-1642-C		Videosystem Ein/Aus Videoüberwachung / video controlling		Stueckliste: parts list: 25186184		Fg.-Gruppe: funct.-group: .33		Blatt-Nr.: page-nr.: 7	
			Ausdruck-Datum: printout-date: 14.12.11				=Container		Steuerstand Control Cabin +ST/CC		Datum: date: 26.08.2011		Bearb.: name: Th		letzte Aenderung: last modification: 14.12.11 Th	
Index Index			Änderung-Nr. Change No.:				Zn.-Nr.: drawn-nr.: 3478-562-002-.33						Blatt-Global: page-global: 151/166		von from 12	

Patent-, Gebrauchsmuster- oder
Geschmacksmuster-Eintragung vorbehalten.
of a patent, utility model or design.

ausdrücklich gestattet. Zuwiderhandlungen verpflichten
zu Schadensersatz. Alle Rechte fuer den Fall der
Auhorisation is prohibited. Offenders will be held liable for the
payment of damages. All rights reserved in the event of the grant

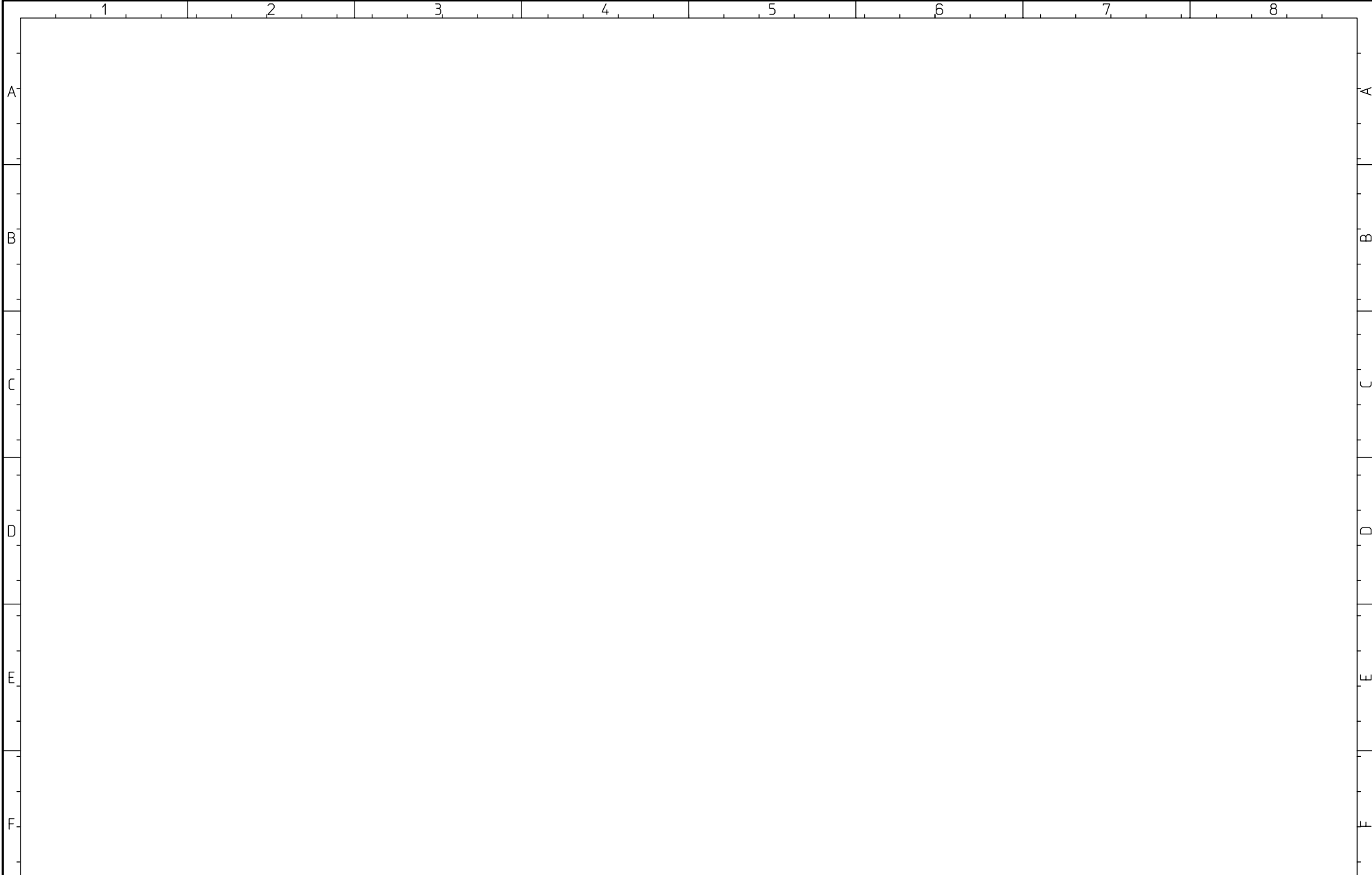
Weitergabe sowie Vervielfaeltigung dieses Dokuments, Verwertung
und Mitteilung seines Inhalts sind verboten, soweit nicht
The reproduction, distribution and utilization of this document as
well as the communication of its contents to others without express



			CAD! KEINE MANUELLEN AENDERUNGEN ! CAD! DONT CHANGE MANUAL	 Herrenknecht AG Schlehenweg 2 D-77963 Schwanau 2 Tel.: 07824 302-0 Fax.: 07824 3403 Info@Herrenknecht.de	Projekt: project: M-1642-C	Reserve reserve	Stueckliste: parts list: 25186184	Fg.-Gruppe: funct.-group: .33	Blatt-Nr.: page-nr.: 8
Index Index	Aenderung-Nr. Change No.:	Datum / Name date / name	Ausdruck-Datum: printout-date: 14.12.11		=Container	Videouberwachung / video controlling			Blatt-Global: page-global: 152/166
					Zn.-Nr.: drawn-nr.: 3478-562-002-.33	Datum: date: 26.08.2011	Bearb.: name: Th	letzte Aenderung: last modification: 14.12.11 Th	

24VDC Video X33-54/1+ /10.1
 0VDC Video X33-54/3- /10.1

Patent-, Gebrauchsmuster- oder
 Geschmacksmuster-Eintragung vorbehalten.
 of a patent, utility model or design.

ausdrücklich gestattet. Zuwiderhandlungen verpflichten
 zu Schadensersatz. Alle Rechte fuer den Fall der
 authorization is prohibited. Offenders will be held liable for the
 payment of damages. All rights reserved in the event of the grant

Weitergabe sowie Vervielfaeltigung dieses Dokuments, Verwertung
 und Mitteilung seines Inhalts sind verboten, soweit nicht
 The reproduction, distribution and utilization of this document as
 well as the communication of its contents to others without express

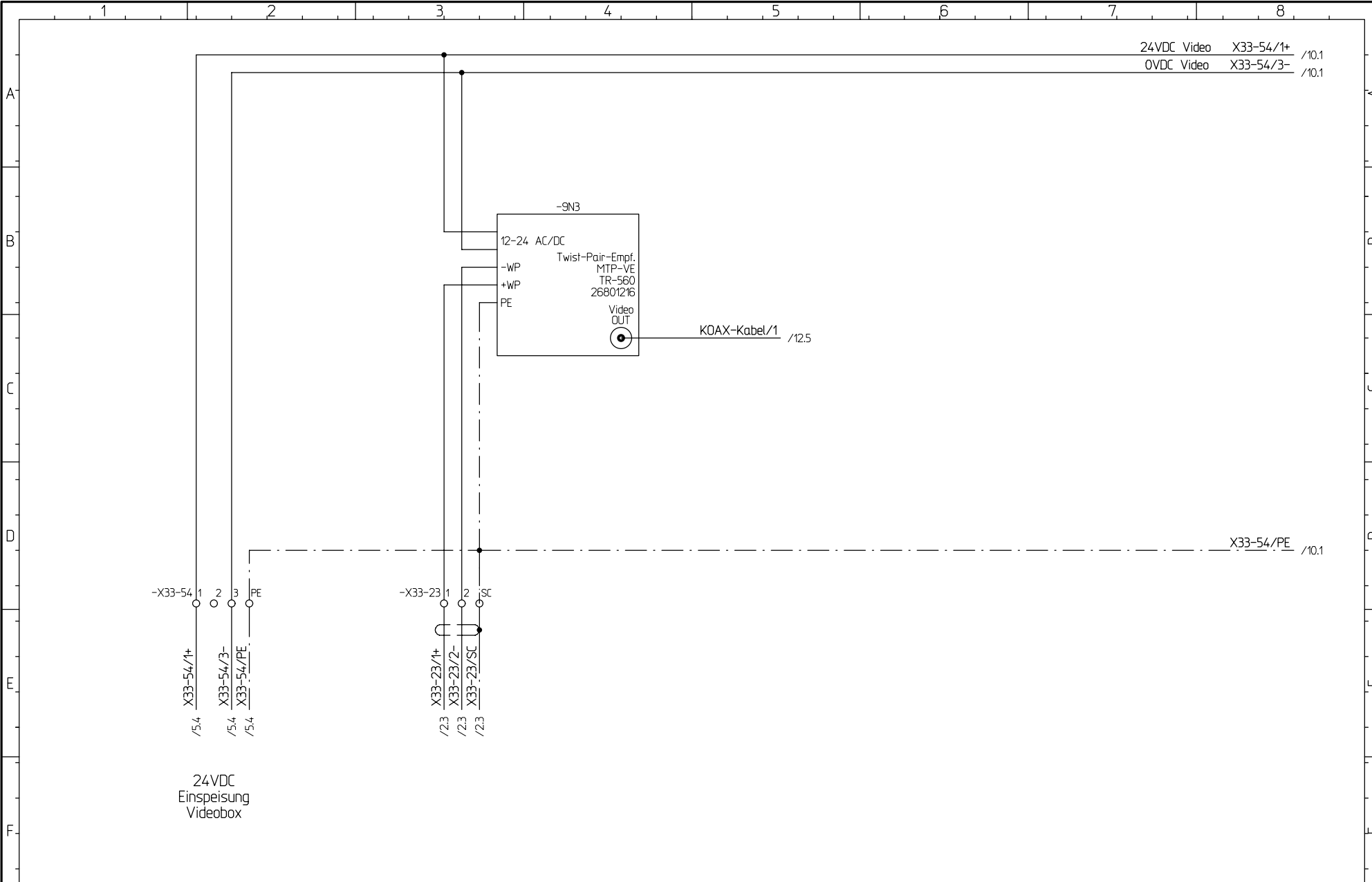

Index	Aenderung-Nr. Change No.:	Datum / Name date / name
Index		

CAD! KEINE MANUELLEN
 AENDERUNGEN!
 CAD!
 DONT CHANGE MANUAL

Ausdruck-Datum:
 printout-date:
 14.12.11



Herrenknecht AG
 Schlehenweg 2
 D-77963 Schwanau 2
 Tel.: 07824 302-0
 Fax.: 07824 3403
 Info@Herrenknecht.de

Projekt:
 project: M-1642-C
 =Container

Zn.-Nr.:
 drawn-nr.: 3478-562-002-.33

Kamera 1
 camera 1
 Videoüberwachung / video controlling

ST-Videobox
 +ST-VBox

Datum:
 date: 26.08.2011

Bearb.:
 name: Th

Stueckliste:
 parts list: 25186184

Fg.-Gruppe:
 funct.-group: .33

Blatt-Nr.:
 page-nr.: 9

Blatt-Global:
 page-global: 153/166

von
 from 12

letzte Aenderung:
 last modification: 14.12.11 Th

IB-Revision 14.12.11 Th

Patent-, Gebrauchsmuster- oder
Geschmacksmuster-Eintragung vorbehalten.
of a patent, utility model or design.

ausdrücklich gestattet. Zuwiderhandlungen verpflichten
zu Schadensersatz. Alle Rechte fuer den Fall der
Autorisation ist prohibited. Offenders will be held liable for the
payment of damages. All rights reserved in the event of the grant

Weitergabe sowie Vervielfaeltigung dieses Dokuments, Verwertung
und Mitteilung seines Inhalts sind verboten, soweit nicht
The reproduction, distribution and utilization of this document as
well as the communication of its contents to others without express

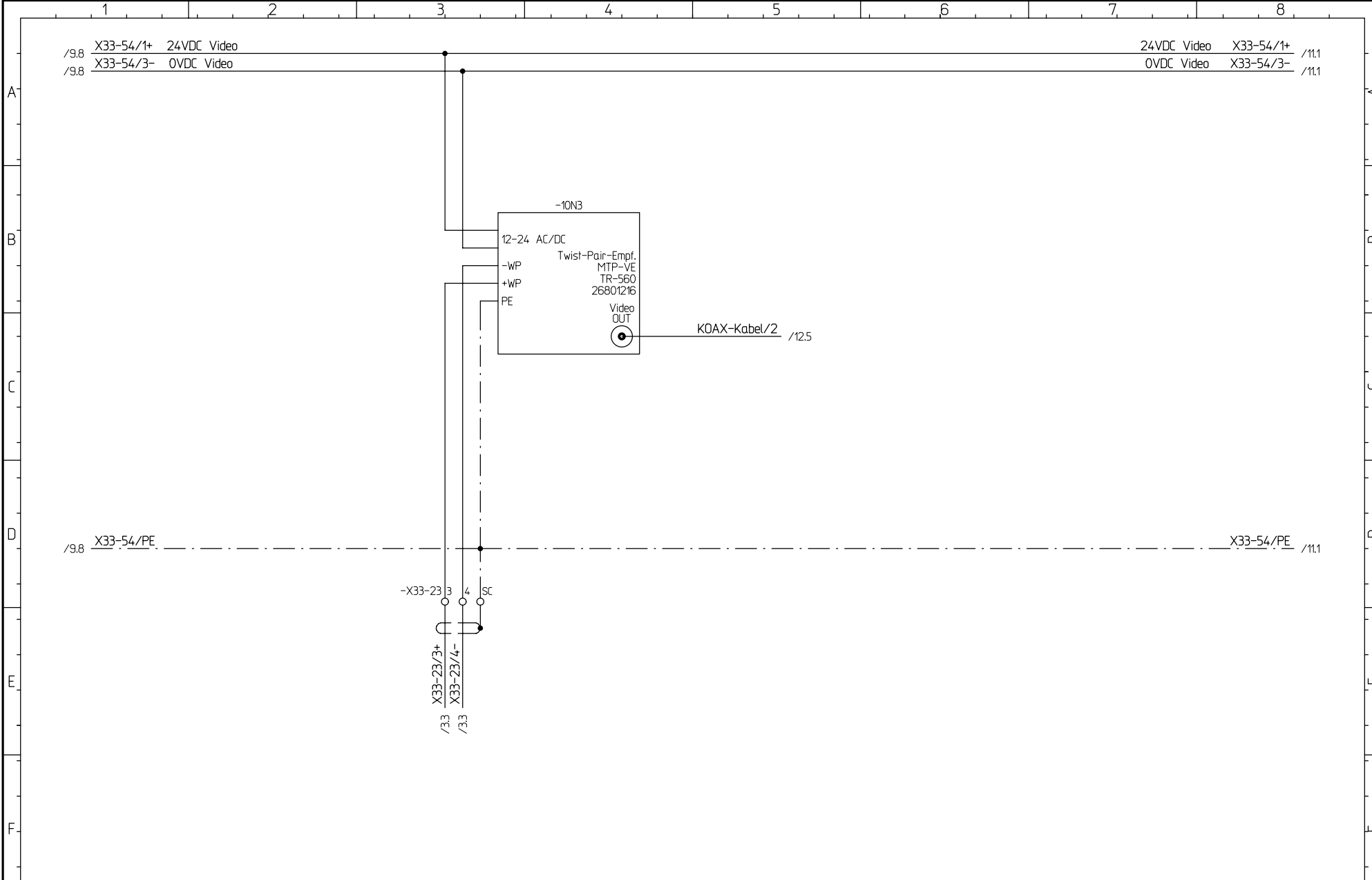

			CAD! KEINE MANUELLEN AENDERUNGEN! CAD! DONT CHANGE MANUAL		 Herrenknecht AG Schlehenweg 2 D-77963 Schwanaau 2 Tel.: 07824 302-0 Fax.: 07824 3403 Info@Herrenknecht.de		Projekt: M-1642-C =Container		Kamera 2 camera 2 Videoüberwachung / video controlling		Stueckliste: parts list: 25186184		Fg.-Gruppe: funct.-group: .33		Blatt-Nr.: page-nr.: 10	
			Ausdruck-Datum: printout-date: 14.12.11				Zn.-Nr.: drawn-nr.: 3478-562-002-.33		ST-VideoBOX +ST-VBox		Datum: date: 26.08.2011		Bearb.: name: Th		letzte Aenderung: last modification: 1B-Revision 14.12.11 Th	
Index Index			Änderung-Nr. Change No.:		Datum / Name date / name								Blatt-Global: page-global: 154/166		von from 12	

Patent-, Gebrauchsmuster- oder
Geschmacksmuster-Eintragung vorbehalten.
of a patent, utility model or design.

ausdrücklich gestattet. Zuwiderhandlungen verpflichten
zu Schadensersatz. Alle Rechte fuer den Fall der
Auhorisation is prohibited. Offenders will be held liable for the
payment of damages. All rights reserved in the event of the grant

Weitergabe sowie Vervielfaeltigung dieses Dokuments, Verwertung
und Mitteilung seines Inhalts sind verboten, soweit nicht
The reproduction, distribution and utilization of this document as
well as the communication of its contents to others without express

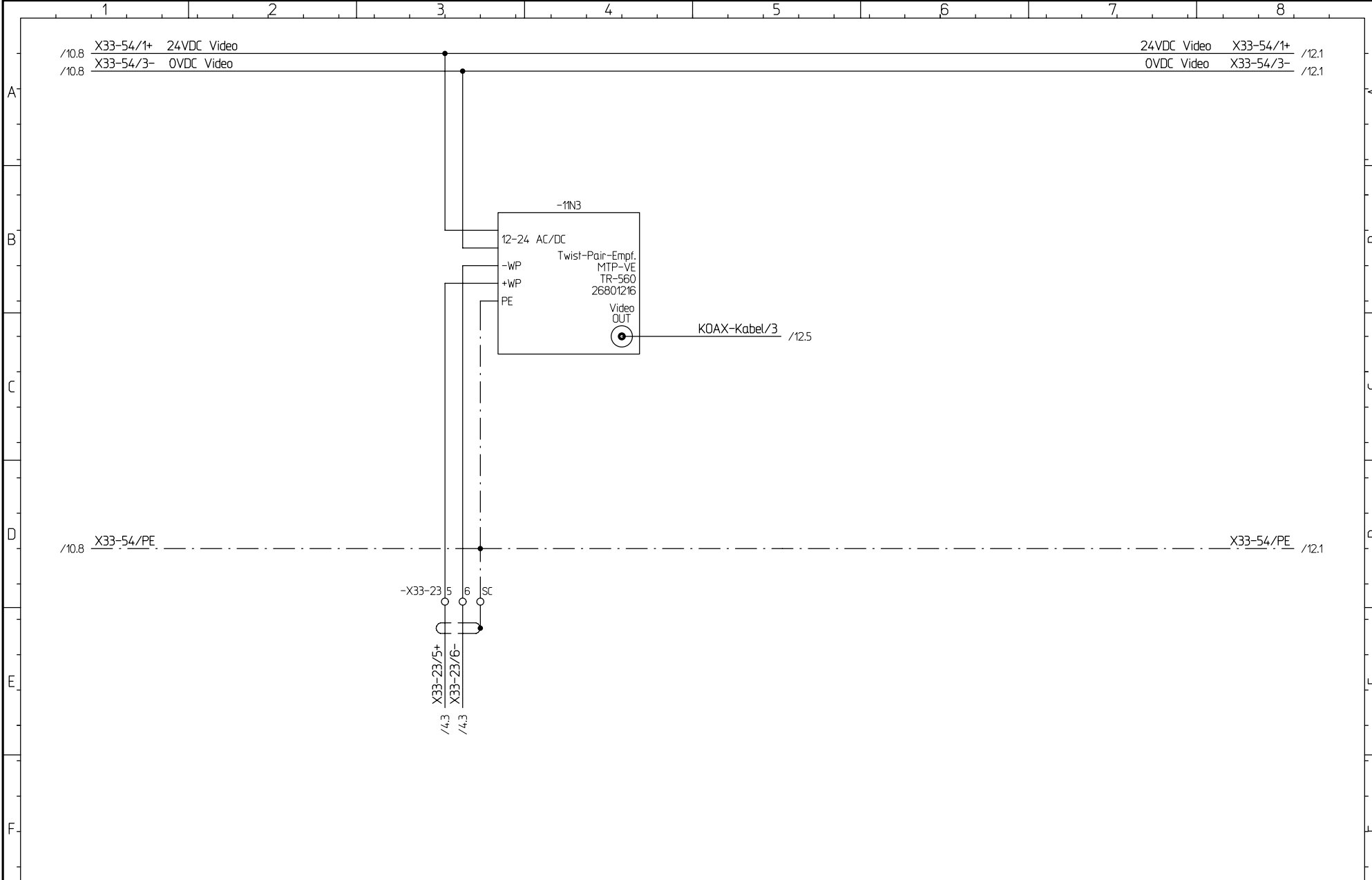

			CAD! KEINE MANUELLEN AENDERUNGEN! CAD! DONT CHANGE MANUAL		Herrenknecht AG Schlehenweg 2 D-77963 Schwanaau 2 Tel.: 07824 302-0 Fax.: 07824 3403 Info@Herrenknecht.de		Projekt: M-1642-C		Kamera 3 camera 3		Stueckliste: parts list: 25186184		Fg.-Gruppe: funct.-group: .33		Blatt-Nr.: page-nr.: 11		
			Ausdruck-Datum: printout-date: 14.12.11		=Container		Videoüberwachung / video controlling										
Index Index	Aenderung-Nr. Change No.:	Datum / Name date / name					Zn.-Nr. drawn-nr.:	3478-562-002-.33		ST-Videobox +ST-VBox		Datum: date:	26.08.2011		Bearb. name:	Th	
													letzte Aenderung: last modification:		14.12.11 Th		
													Blatt-Global: page-global: 155/166		von from 12		

Patent-, Gebrauchsmuster- oder Geschmacksmuster-Eintragung vorbehalten.
 of a patent, utility model or design.
 ausdrucklich gestattet. Zuwiderhandlungen verpflichten zu Schadensersatz. Alle Rechte fuer den Fall der autorisation is prohibited. Offenders will be held liable for the payment of damages. All rights reserved in the event of the grant
 Weitergabe sowie Vervielfaeltigung dieses Dokuments, Verwertung und Mitteilung seines Inhalts sind verboten, soweit nicht The reproduction, distribution and utilization of this document as well as the communication of its contents to others without express

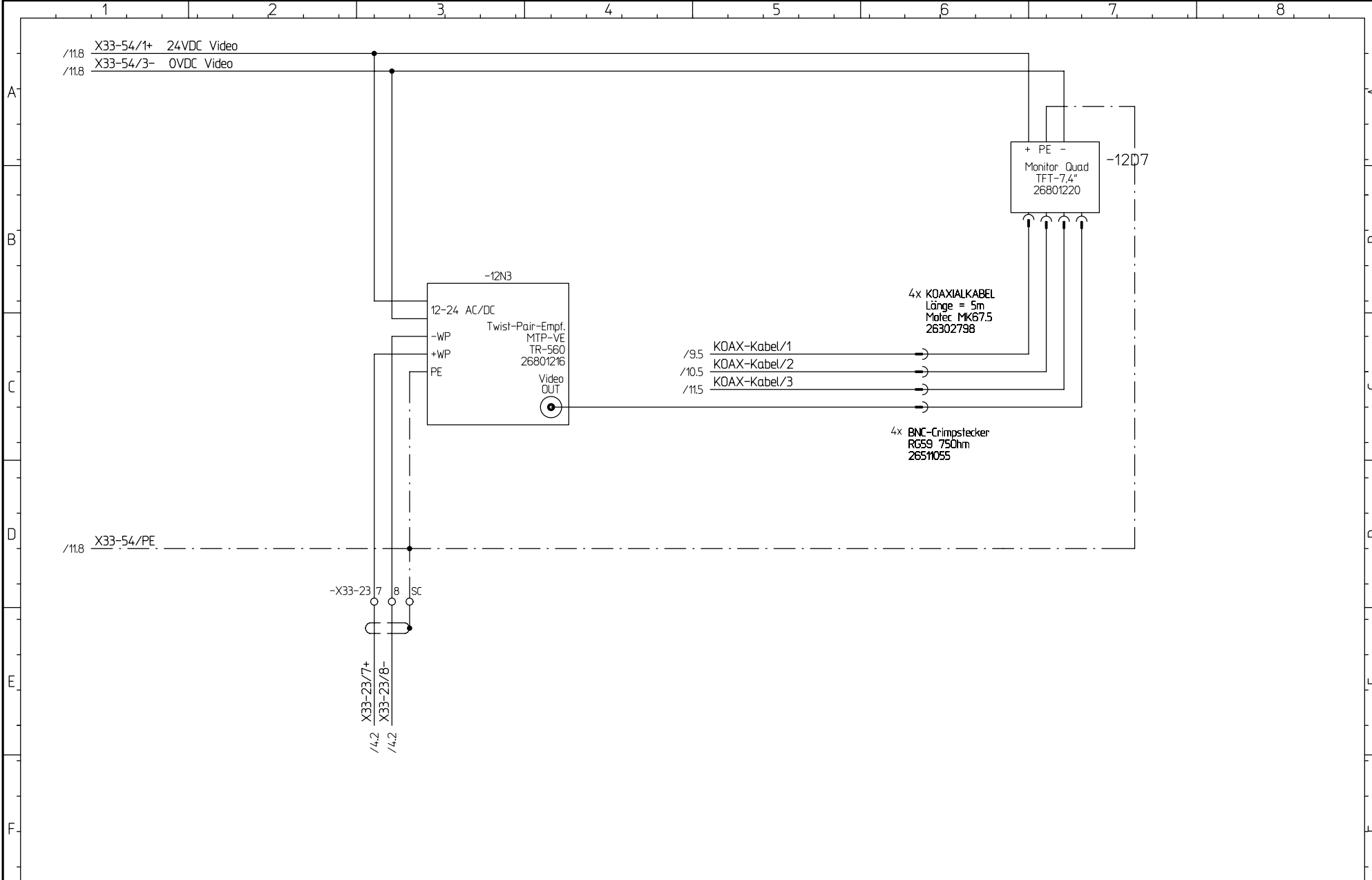

			CAD! KEINE MANUELLEN AENDERUNGEN! CAD! DONT CHANGE MANUAL		Herrenknecht AG Schlehenweg 2 D-77963 Schwanau 2 Tel.: 07824 302-0 Fax.: 07824 3403 Info@Herrenknecht.de		Projekt: project: M-1642-C Kamera 4 camera 4 Videoüberwachung / video controlling		Stueckliste: parts list: 25186184		Fg.-Gruppe: funct.-group: .33		Blatt-Nr.: page-nr.: 12	
			Ausdruck-Datum: printout-date: 14.12.11				=Container		ST-Videoibox +ST-VBox		Datum: date: 26.08.2011		Bearb.: name: Th	
Index Index			Änderung-Nr. Change No.:		Datum / Name date / name		Zn.-Nr.: drawn-nr.: 3478-562-002-.33		letzte Aenderung: last modification: IB-Revision 14.12.11 Th		Blatt-Global: page-global: 156/166		von from 12	

Patent-, Gebrauchsmuster- oder
Geschmacksmuster-Eintragung vorbehalten.
of a patent, utility model or design.

ausdrücklich gestattet. Zuwiderhandlungen verpflichten
zu Schadensersatz. Alle Rechte fuer den Fall der
Auhonanzation is prohibited. Offenders will be held liable for the
payment of damages. All rights reserved in the event of the grant

Weitergabe sowie Vervielfaeltigung dieses Dokuments, Verwertung
und Mitteilung seines Inhalts sind verboten, soweit nicht
The reproduction, distribution and utilization of this document as
well as the communication of its contents to others without express

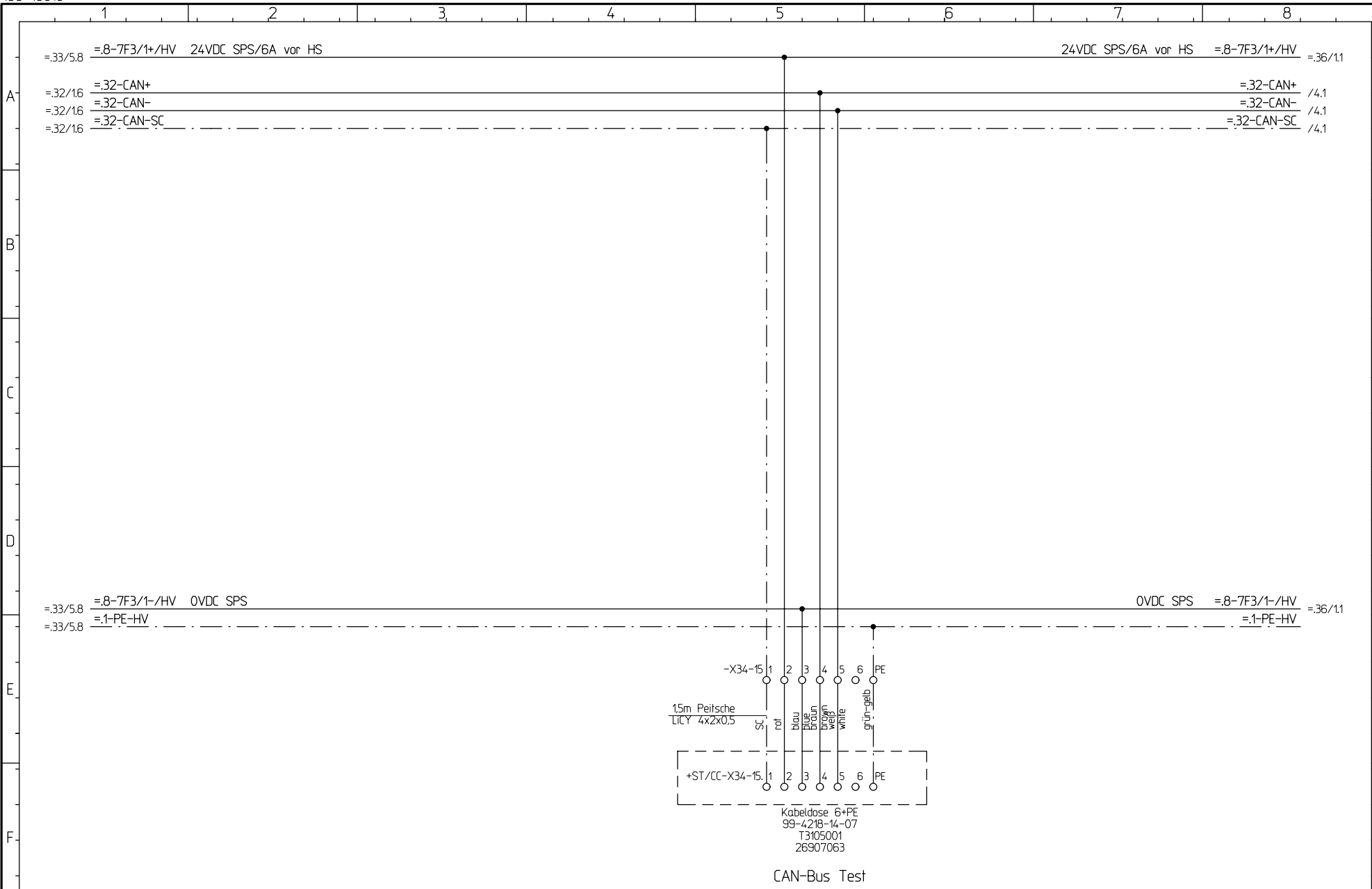

CAN-Bus Test

			CAD! KEINE MANUELLEN AENDERUNGEN! CAD! DONT CHANGE MANUAL		 Herrenknecht AG Schlehenweg 2 D-77963 Schwanaau 2 Tel.: 07824 302-0 Fax.: 07824 3403 Info@Herrenknecht.de		Projekt: project: M-1642-C		Vermessungssystem guidance system		Stueckliste: parts list: 25186184	Fg.-Gruppe: funct.-group: .34	Blatt-Nr.: page-nr.: 1
			Ausdruck-Datum: printout-date: 14.12.11				=Container		Vermessung / guidance system			Blatt-Global: page-global: 157/166	von from 4
Index Index	Aenderung-Nr. Change No.:	Datum / Name date / name					Zn.-Nr.: drawn-nr.: 3478-562-002-.34	Hauptverteilung main distribution board +HV/ MDB	Datum: date: 26.08.2011	Bearb.: name: Th	letzte Aenderung: last modification: 1B-Revision 14.12.11 Th		

Patent-, Gebrauchsmuster- oder Geschmacksmuster-Eintragung vorbehalten.
 of a patent, utility model or design.

ausdrücklich gestattet. Zuwiderhandlungen verpflichten zu Schadensersatz. Alle Rechte fuer den Fall der Auhorisation ist prohibited. Offenders will be held liable for the payment of damages. All rights reserved in the event of the grant

Weitergabe sowie Vervielfaeltigung dieses Dokuments, Verwertung und Mitteilung seines Inhalts sind verboten, soweit nicht The reproduction, distribution and utilization of this document as well as the communication of its contents to others without express

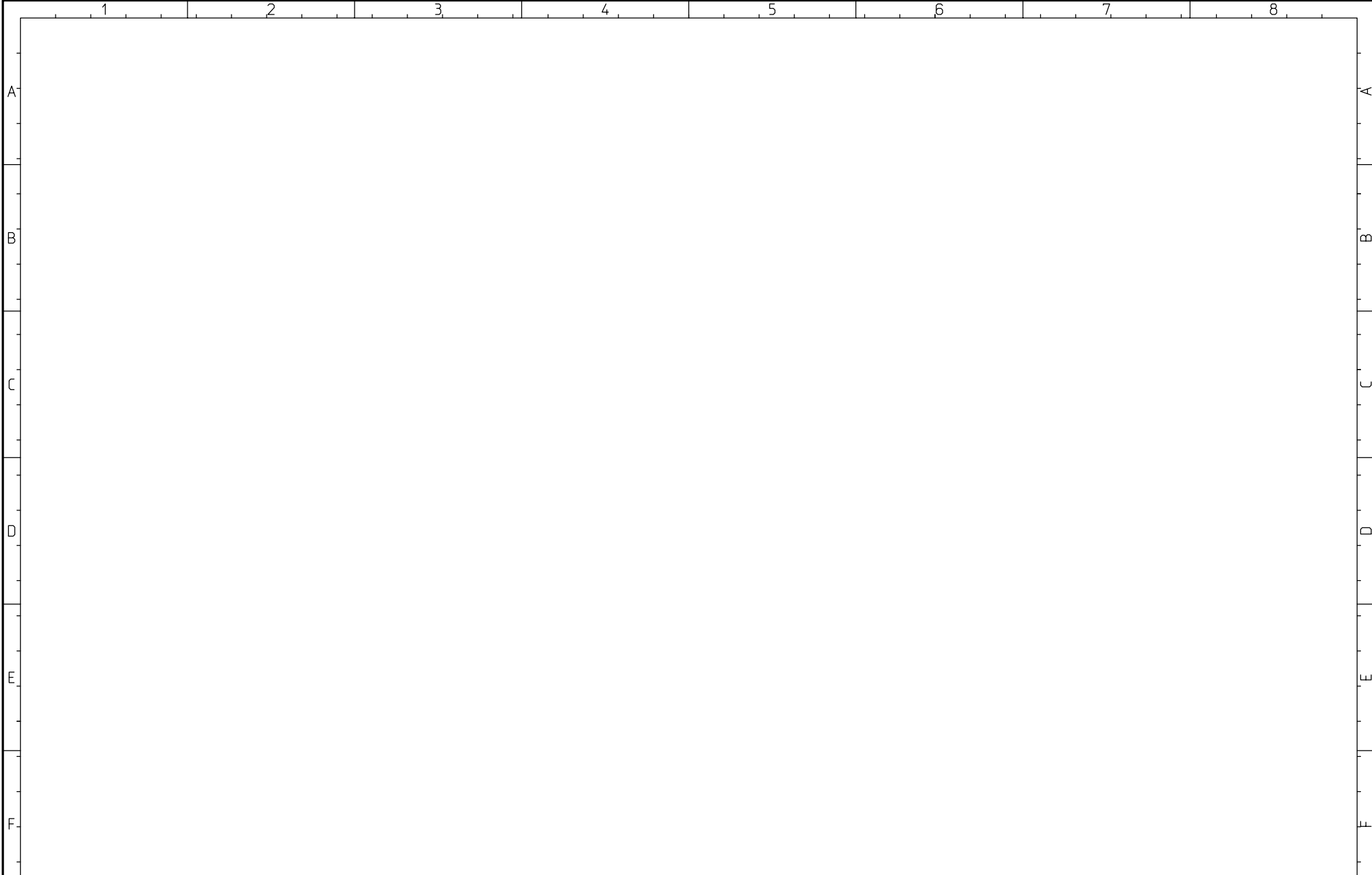

			CAD! KEINE MANUELLEN AENDERUNGEN ! CAD! DONT CHANGE MANUAL	 Herrenknecht AG Schlehenweg 2 D-77963 Schwanau 2 Tel.: 07824 302-0 Fax.: 07824 3403 Info@Herrenknecht.de	Projekt: project: M-1642-C	Reserve reserve	Stueckliste: parts list: 25186184	Fg.-Gruppe: funct.-group: .34	Blatt-Nr.: page-nr.: 2	
Index Index	Aenderung-Nr. Change No.:	Datum / Name date / name	Ausdruck-Datum: printout-date: 14.12.11		=Container	Zn.-Nr.: drawn-nr.: 3478-562-002-.34	Datum: date: 26.08.2011	Bearb.: name: Th	letzte Aenderung: last modification: 14.12.11 Th	Blatt-Global: page-global: 158/166

Patent-, Gebrauchsmuster- oder Geschmacksmuster-Eintragung vorbehalten.
 of a patent, utility model or design.
 ausdrucklich gestattet. Zuwiderhandlungen verpflichten zu Schadensersatz. Alle Rechte fuer den Fall der Auhonanzation is prohibited. Offenders will be held liable for the payment of damages. All rights reserved in the event of the grant
 Weitergabe sowie Vervielfaeltigung dieses Dokuments, Verwertung und Mitteilung seines Inhalts sind verboten, soweit nicht The reproduction, distribution and utilization of this document as well as the communication of its contents to others without express

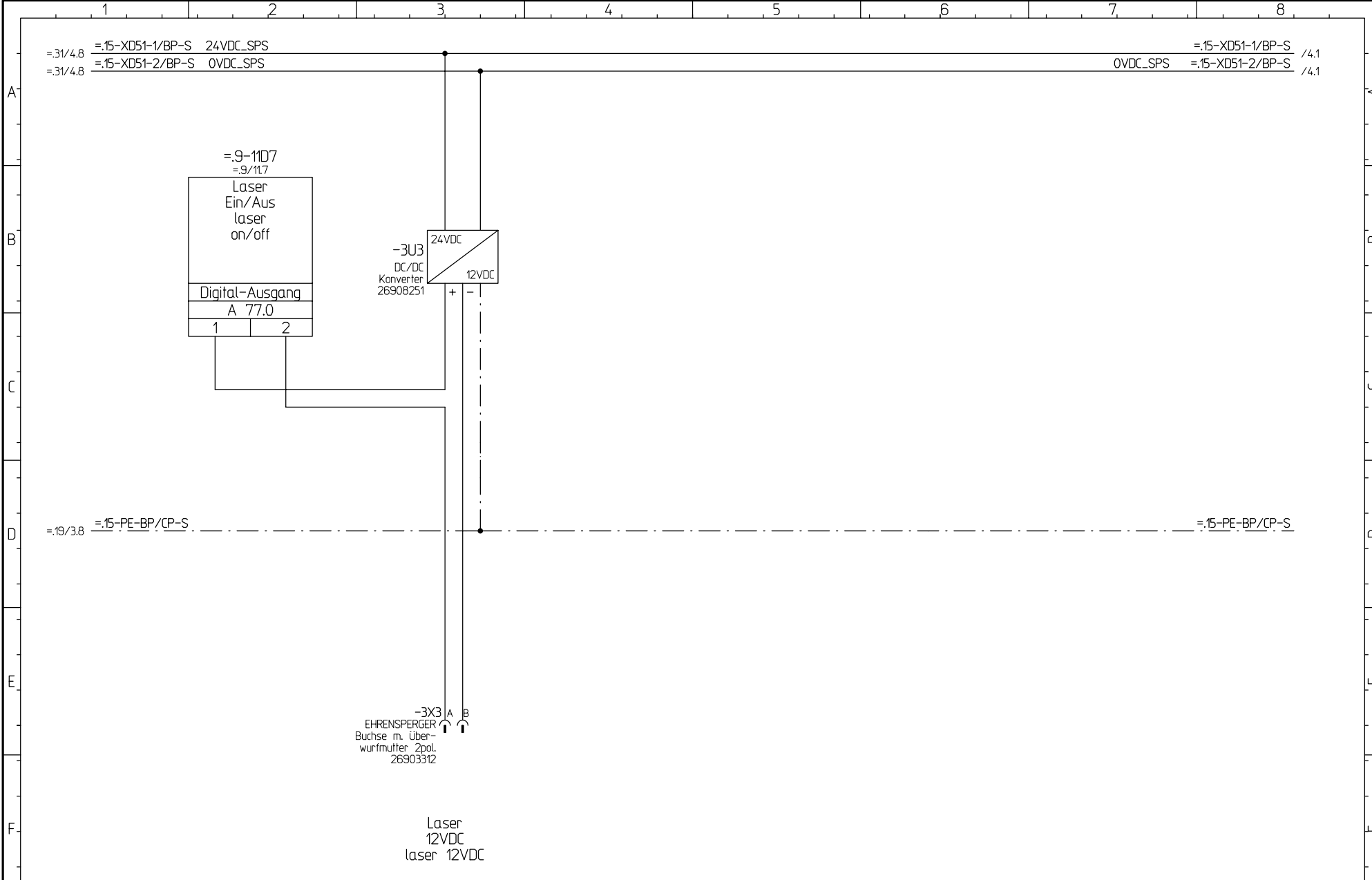

			CAD! KEINE MANUELLEN AENDERUNGEN! CAD! DONT CHANGE MANUAL		Herrenknecht AG Schlehenweg 2 D-77963 Schwanau 2 Tel.: 07824 302-0 Fax.: 07824 3403 Info@Herrenknecht.de		Projekt: M-1642-C =Container		Laser Ein/Aus laser on/off Vermessung / guidance system		Stueckliste: parts list: 25186184		Fg.-Gruppe: funct.-group: .34		Blatt-Nr.: page-nr.: 3	
			Ausdruck-Datum: printout-date: 14.12.11				Zn.-Nr.: drawn-nr.: 3478-562-002-.34		Bedienpult Schacht control panel shaft +BP/CP-S		Datum: date: 26.08.2011		Bearb.: name: Th		letzte Aenderung: last modification: IB-Revision 14.12.11 Th	
Index Index			Änderung-Nr. Change No.:												Blatt-Global: page-global: 159/166	

Patent-, Gebrauchsmuster- oder Geschmacksmuster-Eintragung vorbehalten. of a patent, utility model or design.
 ausdrucklich gestattet. Zuwiderhandlungen verpflichten zu Schadenersatz. Alle Rechte fuer den Fall der authorisation is prohibited. Offenders will be held liable for the payment of damages. All rights reserved in the event of the grant
 Weitergabe sowie Vervielfaeltigung dieses Dokuments, Verwertung und Mitteilung seines Inhalts sind verboten, soweit nicht The reproduction, distribution and utilization of this document as well as the communication of its contents to others without express

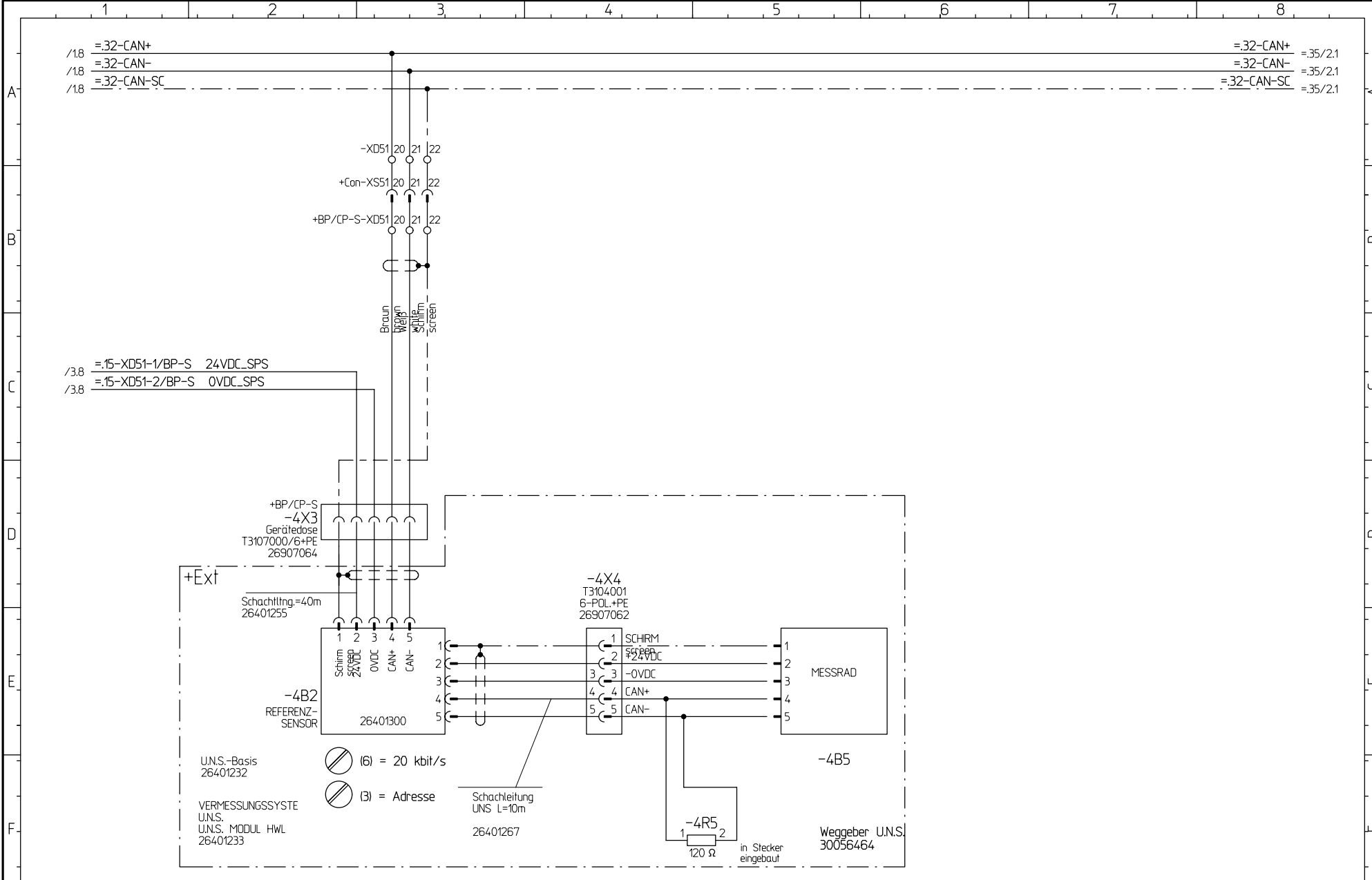

			CAD! KEINE MANUELLEN AENDERUNGEN! CAD! DONT CHANGE MANUAL		Herrenknecht AG Schlehenweg 2 D-77963 Schwanaau 2 Tel.: 07824 302-0 Fax: 07824 3403 Info@Herrenknecht.de		Projekt: M-1642-C =Container		Vermessungssystem guidance system Vermessung / guidance system		Stueckliste: parts list: 25186184		Fg.-Gruppe: funct.-group: .34		Blatt-Nr.: page-nr.: 4	
			Ausdruck-Datum: printout-date: 14.12.11				Zn.-Nr.: drawn-nr.: 3478-562-002-.34		Hauptverteilung main distribution board +HV/MBB		Datum: date: 26.08.2011		Bearb.: name: Th		letzte Aenderung: last modification: 14.12.11 Th	
													Blatt-Global: page-global: 160/166		von from	

Patent-, Gebrauchsmuster- oder Geschmacksmuster-Eintragung vorbehalten.
 of a patent, utility model or design.
 ausdrucklich gestattet. Zuwiderhandlungen verpflichten zu Schadenersatz. Alle Rechte fuer den Fall der autorisation is prohibited. Offenders will be held liable for the payment of damages. All rights reserved in the event of the grant
 Weitergabe sowie Vervielfaeltigung dieses Dokuments, Verwertung und Mitteilung seines Inhalts sind verboten, soweit nicht The reproduction, distribution and utilization of this document as well as the communication of its contents to others without express

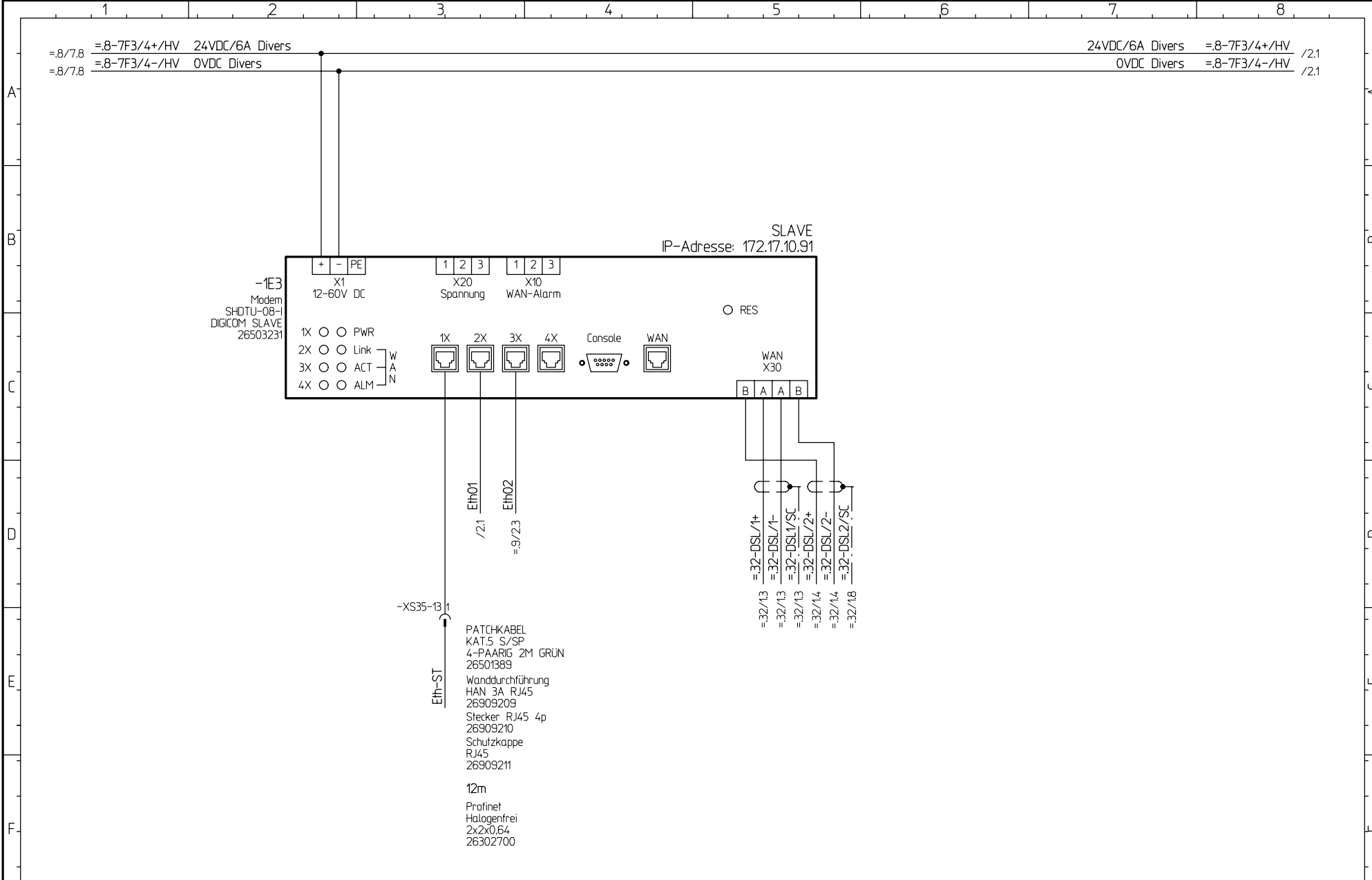

			CAD! KEINE MANUELLEN AENDERUNGEN! CAD! DONT CHANGE MANUAL		 Herrenknecht AG Schleheweg 2 D-77963 Schwanau 2 Tel.: 07824 302-0 Fax.: 07824 3403 Info@Herrenknecht.de	Projekt: M-1642-C =Container		DSL Modem Datenerfass., PC / datacollect.computer		Stueckliste: parts list: 25186184		Fg.-Gruppe: funct.-group: .35		Blatt-Nr.: page-nr.: 1				
Ausdruck-Datum: printout-date: 14.12.11						Zn.-Nr.: drawn-nr.: 3478-562-002-.35		Hauptverteilung main distribution board +HV/MB		Datum: date: 26.08.2011		Bearb.: name: Th		letzte Aenderung: last modification: IB-Revision 14.12.11 Th		Blatt-Global: page-global: 161/166		von from 4

Patent-, Gebrauchsmuster- oder Geschmacksmuster-Eintragung vorbehalten.
 of a patent, utility model or design.
 ausdrucklich gestattet. Zuwiderhandlungen verpflichten zu Schadenersatz. Alle Rechte fuer den Fall der Autorisation is prohibited. Offenders will be held liable for the payment of damages. All rights reserved in the event of the grant
 Weitergabe sowie Vervielfaeltigung dieses Dokuments, Verwertung und Mitteilung seines Inhalts sind verboten, soweit nicht The reproduction, distribution and utilization of this document as well as the communication of its contents to others without express

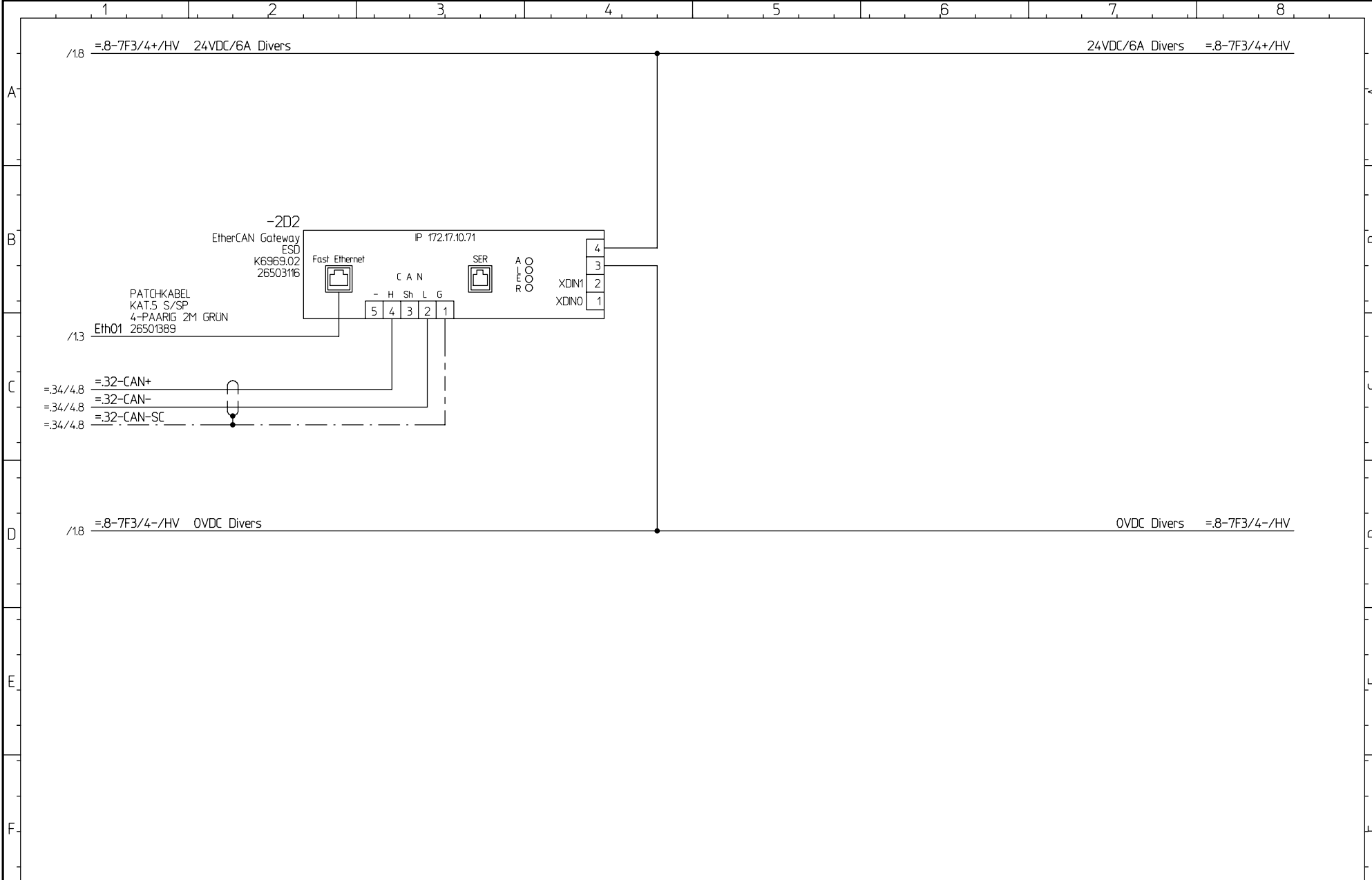

			CAD! KEINE MANUELLEN AENDERUNGEN! CAD! DONT CHANGE MANUAL		 Herrenknecht AG Schlehenweg 2 D-77963 Schwanau 2 Tel.: 07824 302-0 Fax.: 07824 3403 Info@Herrenknecht.de	Projekt: M-1642-C project: =Container		CAN-Anschaltung CAN-interface Datenerfass., PC / datacollect.computer		Stueckliste: parts list: 25186184		Fg.-Gruppe: funct.-group: .35		Blatt-Nr.: page-nr.: 2				
Ausdruck-Datum: printout-date: 14.12.11						Zn.-Nr.: drawn-nr.: 3478-562-002-.35		Hauptverteilung main distribution board +HV/MDB		Datum: date: 26.08.2011		Bearb.: name: Th		letzte Aenderung: last modification: 14.12.11 Th		Blatt-Global: page-global: 162/166		von from 4

Patent-, Gebrauchsmuster- oder Geschmacksmuster-Eintragung vorbehalten.
 of a patent, utility model or design.
 ausdrucklich gestattet. Zuwiderhandlungen verpflichten zu Schadensersatz. Alle Rechte fuer den Fall der authorisation is prohibited. Offenders will be held liable for the payment of damages. All rights reserved in the event of the grant
 Weitergabe sowie Vervielfaeltigung dieses Dokuments, Verwertung und Mitteilung seines Inhalts sind verboten, soweit nicht The reproduction, distribution and utilization of this document as well as the communication of its contents to others without express

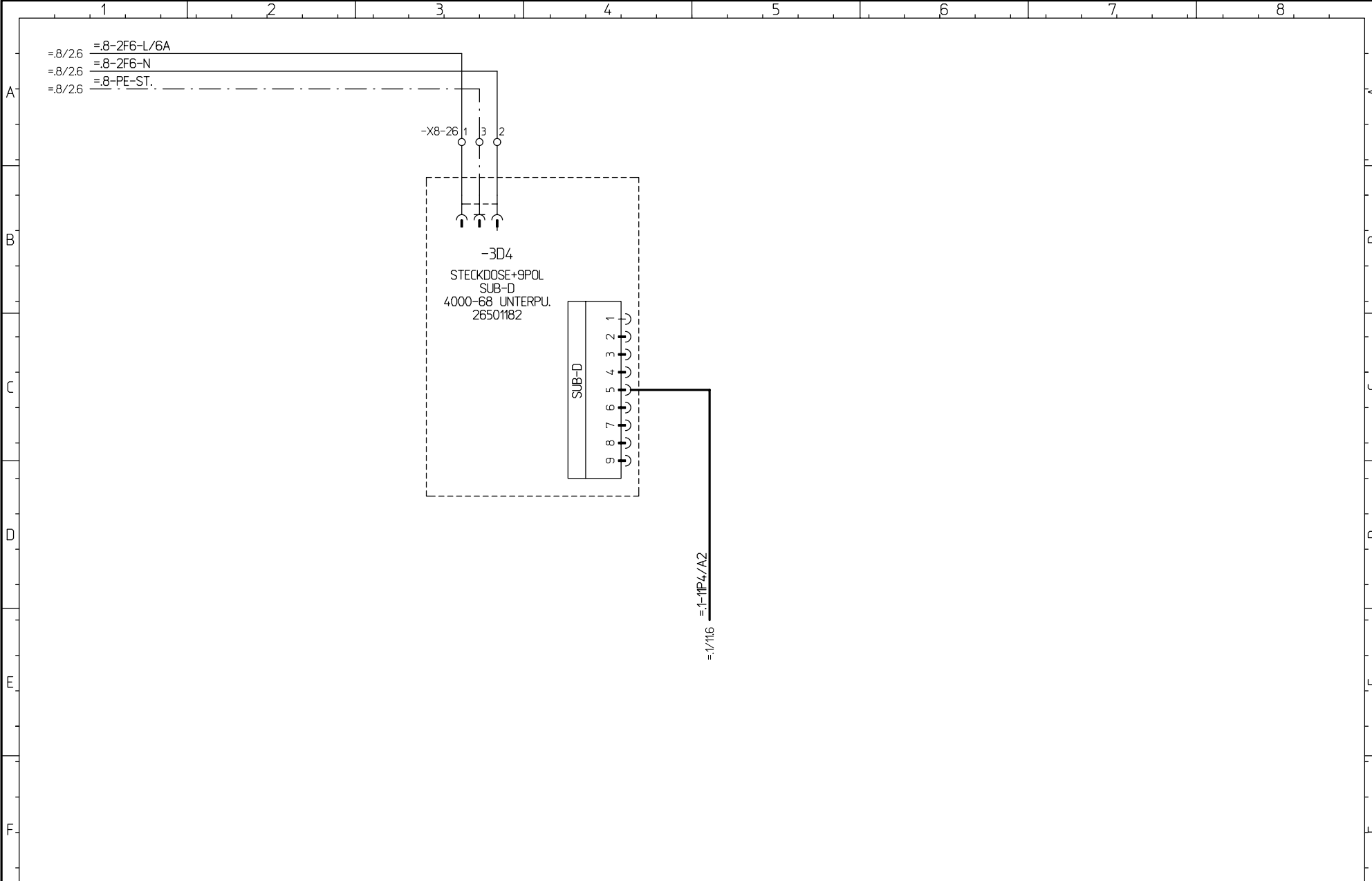



			CAD! KEINE MANUELLEN AENDERUNGEN! CAD! DONT CHANGE MANUAL		Herrenknecht AG Schlehenweg 2 D-77963 Schwanau 2 Tel.: 07824 302-0 Fax.: 07824 3403 Info@Herrenknecht.de		Projekt: project: M-1642-C		PG/PC Interface PG/PC interface Datenerfass., PC / datacollect.computer		Stueckliste: parts list: 25186184		Fg.-Gruppe: funct.-group: .35		Blatt-Nr.: page-nr.: 3	
			Ausdruck-Datum: printout-date: 14.12.11				=Container		Steuerstand Control Cabin +ST/CC		Datum: date: 26.08.2011		Bearb.: name: Th		letzte Aenderung: last modification: 14.12.11 Th	
Index Index			Änderung-Nr. Change No.:				Zn.-Nr.: drawn-nr.: 3478-562-002-.35				Blatt-Global: page-global: 163/166		von from 4			

Patent-, Gebrauchsmuster- oder Geschmacksmuster-Eintragung vorbehalten.
 of a patent, utility model or design.

ausdrücklich gestattet. Zuwiderhandlungen verpflichten zu Schadensersatz. Alle Rechte fuer den Fall der Auhonanzation is prohibited. Offenders will be held liable for the payment of damages. All rights reserved in the event of the grant

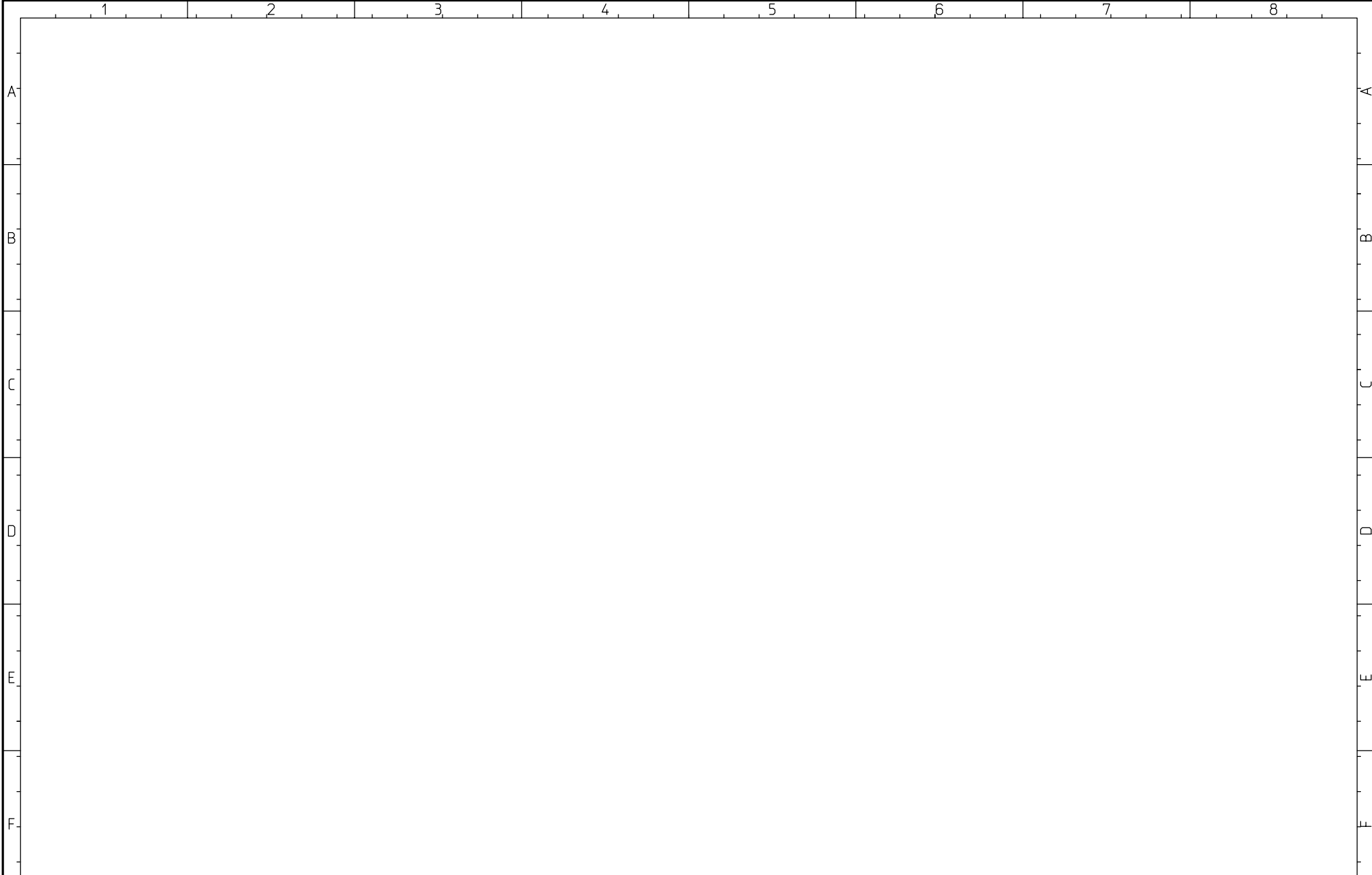
Weitergabe sowie Vervielfaeltigung dieses Dokuments, Verwertung und Mitteilung seines Inhalts sind verboten, soweit nicht The reproduction, distribution and utilization of this document as well as the communication of its contents to others without express



			CAD! KEINE MANUELLEN AENDERUNGEN ! CAD! DONT CHANGE MANUAL	 Herrenknecht AG Schlehenweg 2 D-77963 Schwanau 2 Tel.: 07824 302-0 Fax.: 07824 3403 Info@Herrenknecht.de	Projekt: project: M-1642-C	Reserve reserve	Stueckliste: parts list: 25186184	Fg.-Gruppe: funct.-group: .35	Blatt-Nr.: page-nr.: 4
Index Index	Aenderung-Nr. Change No.:	Datum / Name date / name	Ausdruck-Datum: printout-date: 14.12.11		=Container	Datenerfass., PC / datacollect.computer		Blatt-Global: page-global: 164/166	von from 4
					Zn.-Nr.: drawn-nr.: 3478-562-002-.35	Datum: date: 26.08.2011	Bearb.: name: Th	letzte Aenderung: last modification: 14.12.11 Th	

Patent-, Gebrauchsmuster- oder Geschmacksmuster-Eintragung vorbehalten. of a patent, utility model or design.
 ausdrucklich gestattet. Zuwiderhandlungen verpflichten zu Schadenersatz. Alle Rechte fuer den Fall der authorisation is prohibited. Offenders will be held liable for the payment of damages. All rights reserved in the event of the grant
 Weitergabe sowie Vervielfaeltigung dieses Dokuments, Verwertung und Mitteilung seines Inhalts sind verboten, soweit nicht The reproduction, distribution and utilization of this document as well as the communication of its contents to others without express

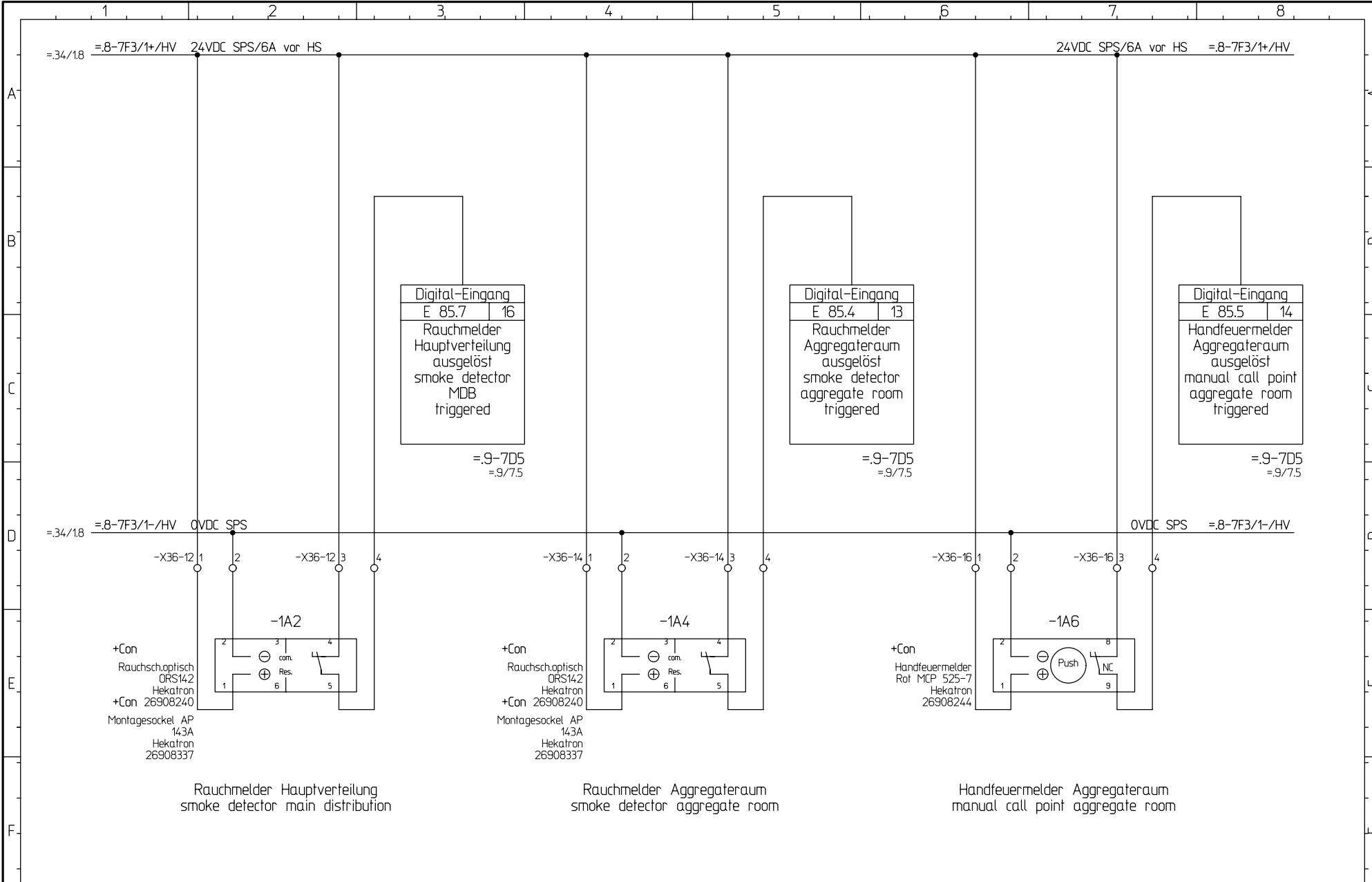



CAD! KEINE MANUELLEN AENDERUNGEN! CAD! DONT CHANGE MANUAL			 Herrenknecht AG Schlehenweg 2 D-77963 Schwanaau 2 Tel.: 07824 302-0 Fax: 07824 3403 Info@Herrenknecht.de	Projekt: M-1642-C =Container		Rauchmelder Container smoke detector container Rauchmelder / smoke detectors		Stueckliste: parts list: 25186184		Fg.-Gruppe: funct.-group: .36		Blatt-Nr.: page-nr.: 1				
Ausdruck-Datum: printout-date: 14.12.11				Zn.-Nr.: drawn-nr.: 3478-562-002-.36		Hauptverteilung main distribution board +HV/MDB		Datum: date: 26.08.2011		Bearb.: name: Th		letzte Aenderung: last modification: IB-Revision 14.12.11 Th		Blatt-Global: page-global: 165/166		von from 2

Patent-, Gebrauchsmuster- oder Geschmacksmuster-Eintragung vorbehalten.
 of a patent, utility model or design.

ausdrücklich gestattet. Zuwiderhandlungen verpflichten zu Schadensersatz. Alle Rechte fuer den Fall der Autorisation ist prohibited. Offenders will be held liable for the payment of damages. All rights reserved in the event of the grant

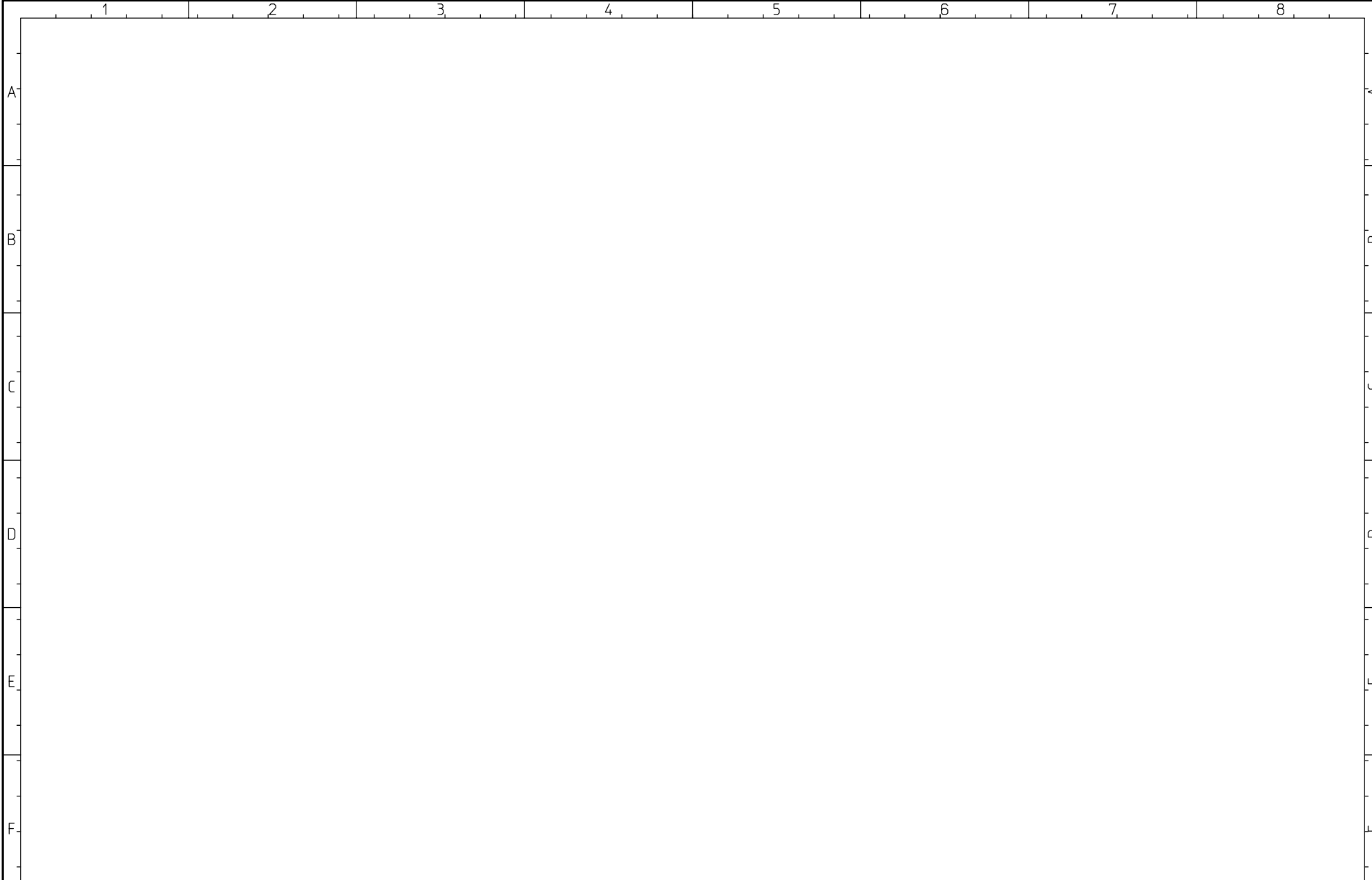
Weitergabe sowie Vervielfaeltigung dieses Dokuments, Verwertung und Mitteilung seines Inhalts sind verboten, soweit nicht The reproduction, distribution and utilization of this document as well as the communication of its contents to others without express



			CAD! KEINE MANUELLEN AENDERUNGEN ! CAD! DONT CHANGE MANUAL	 Herrenknecht AG Schlehenweg 2 D-77963 Schwanau 2 Tel.: 07824 302-0 Fax.: 07824 3403 Info@Herrenknecht.de	Projekt: project: M-1642-C	Reserve reserve	Stueckliste: parts list: 25186184	Fg.-Gruppe: funct.-group: .36	Blatt-Nr.: page-nr.: 2
Index Index	Aenderung-Nr. Change No.:	Datum / Name date / name	Ausdruck-Datum: printout-date: 14.12.11		=Container	Rauchmelder / smoke detectors		Blatt-Global: page-global: 166/166	von from 2
				Zn.-Nr.: drawn-nr.: 3478-562-002-.36	Datum: date: 26.08.2011	Bearb.: name: Th	letzte Aenderung: last modification: 14.12.11 Th		

Klemmenleiste Terminal Strip

-XD40
Aggregat-Dose

+AGG_XD40
Aggregatdose XD40

Leistenort
Term.Strip Place

Klemmen- Type of Terminal	Position position	Nr. No.	Brücken Bridges	Übersweis cross reference	Verwendungswek Application	Fluid	Innen inside	Verbindung Connection	außen
Kabel 36x1mm²									
Klemme, 3450 4mm2		1		=Container:22/3,2	Not-AUS emergency stop		+AGG_XD40 Aggregatdose XD40	=Container:22-3S2 :1	=Container:22-XD40-1
Klemme, 3450 4mm2		2		=Container:22/3,3	Not-AUS emergency stop		+AGG_XD40 Aggregatdose XD40	=Container:22-3S2 :2	=Container:22-XD40-2
Klemme, 3450 4mm2		3		=Container:22/3,3	Not-AUS emergency stop		+AGG_XD40 Aggregatdose XD40	=Container:22-3S2 :1	=Container:22-XD40-3
Klemme, 3450 4mm2		4		=Container:22/3,3	Not-AUS emergency stop		+AGG_XD40 Aggregatdose XD40	=Container:22-3S2 :2	=Container:22-XD40-4
Klemme, 3450 4mm2		5							
Klemme, 3450 4mm2		6							
Klemme, 3450 4mm2		7		=Container:8/12,2	Wartungsschalter maintenance switch		+HV/KDB Hauptverteilung main distribution board	-XD40 :1	+Ext Extern/external external/external
Klemme, 3450 4mm2		8							
Klemme, 3450 4mm2		9		=Container:11/2,3	24VDC SPS		+Con Material Container material container	-XS40 :9	=Container:11-XD40-9
Klemme, 3450 4mm2		10		=Container:11/2,3	0VDC SPS		+Con Material Container material container	-XS40 :10	=Container:11-XD40-10
Klemme, 3450 4mm2		11		=Container:11/2,3	24VDC Ventilie		+Con Material Container material container	-XS40 :11	=Container:15-XD40-11
Klemme, 3450 4mm2		12		=Container:11/2,3	0VDC Ventilie		+Con Material Container material container	-XS40 :12	=Container:15-XD40-12
Klemme, 3450 4mm2		13		=Container:22/3,3			+AGG_XD40 Aggregatdose XD40	=Container:22-3S2 :3	=Container:22-XD40-13

Änderung Change	Datum date	Name name	Begr. checked	Ausdruck-Datum printout-date		Hersteller AG Schäferweg 2 D-70924 Stuttgart 2 Tel: 07142 300-0 Fax: 07142 3403
--------------------	---------------	--------------	------------------	---------------------------------	--	---

M-1642-C

Auftr.-Nr. Order No.	102957	Bearb. Th name		Bearb. Th date	
Zwang.-Nr. drawing-no.	3478-562-002				

Weitergabe sowie Vervielfältigung dieses Dokuments, Verwertung und Mitteilung seines Inhalts sind verboten, soweit nicht ausdrücklich anders angegeben.
 The reproduction, distribution and utilization of this document as well as the communication of its contents to others without express

ausdrücklich gestattet. Zuwiderhandlungen verpflichten zu Schadenersatz. Alle Rechte für den Fall der Patentierung vorbehalten.
 payment of damages. All rights reserved in the event of the grant

Patent-, Gebrauchsmuster- oder Geschmacksmuster-Eintragung vorbehalten.
 of a patent, utility model or design.

Klemmenleiste Terminal Strip

-XD40
Aggregat-Dose

+AGG_XD40
Aggregatdose XD40

Leistenort
Term.Strip Place

Klemmentyp Type of Terminal	Position position	Nr. No.	Brücken Bridges	Übersweis cross reference	Verwendungswerk Application	Fluid Fluid	Innen inside	Verbindung Connection	außen outside
Kabel 36x1mm²									
Klemme, 3x50 4mm2		14		=Container:1/2,4	Reserve 14 reserve 14		+Con Material Container material container	-XS40 :14	
Klemme, 3x50 4mm2		15		=Container:1/2,4	Reserve 15 reserve 15		+Con Material Container material container	-XS40 :15	
Klemme, 3x50 4mm2		16		=Container:1/2,4	PE 16 PE 16		+Con Material Container material container	-XS40 :16	
Klemme, 3x50 4mm2		17		=Container:9/9,1	Profibus + Grün profibus + green		=Container:9-9D2 AGG_XD40 Aggregatdose XD40	-XS40 :A1	+Con Material Container material container
Klemme, 3x50 4mm2		18		=Container:9/9,1	Profibus - Gelb profibus - yellow		=Container:9-9D2 AGG_XD40 Aggregatdose XD40	-XS40 :B1	+Con Material Container material container
Klemme, 3x50 4mm2		19		=Container:9/9,1	Profibus Schirm Schirm profibus screen screen		=Container:9-9D2 AGG_XD40 Aggregatdose XD40	-XS40 :19	+Con Material Container material container
Klemme, 3x50 4mm2		20		=Container:1/2,4	Profibus Reserve + Braun profibus reserve + brown		+Con Material Container material container	-XS40 :20	
Klemme, 3x50 4mm2		21		=Container:1/2,4	Profibus Reserve - Weiß profibus reserve - white		+Con Material Container material container	-XS40 :21	
Klemme, 3x50 4mm2		22		=Container:1/2,4	Profibus Reserve Schirm Schirm profibus reserve screen screen		+Con Material Container material container	-XS40 :22	
Klemme, 3x50 4mm2		23							
Klemme, 3x50 4mm2		24							

Klemmen-Gruppe	Druck-Name	Grp. checked	Ausdruck-Datum print-out-date		Herstellernr. AG Schaltentwurf Zentrum 2 Tel.: 07824 3002-0 Fax: 07824 3403
	Druck-Name		14.12.11		

M-1642-C

Auftr.-Nr.: 102957
 Zeich.-Nr.:
 Order No.:
 drawing-no.: 34.78-562-002

Bearb. Th
name
date

Bearb. Th
name
date

Weitergabe sowie Vervielfältigung dieses Dokuments, Verwertung und Mitteilung seines Inhalts sind verboten, soweit nicht ausdrücklich gestattet. Die Reproduktion, Distribution und Nutzung dieses Dokuments ist ohne schriftliche Genehmigung der Phoenix Contact AG. The reproduction, distribution and utilization of this document as well as the communication of its contents to others without express

ausdrücklich gestattet. Zuwiderhandlungen verpflichten zu Schadenersatz. Alle Rechte für den Fall der Patentierung sind vorbehalten. Schutzzustand ist durch die Patentschrift geschützt. All rights reserved in the event of the grant of a patent, utility model or design.

Patent-, Gebrauchsmuster- oder Geschmacksmuster-Eintragung vorbehalten.

Klemmenleiste Terminal Strip

-XD51 Schachtverbindung

+BP/CP-S Bedienpult Schacht control panel shaft

Leistenort Term.Strip Place

Klemmen- Type of Terminal	Position position	Nr. No.	Brücken Bridges	Übersichts- cross reference	Verwendungszweck Application	Fluid	Innen inside	Verbindung Connection	außen outside
Kabel Cable									
Klemme, 3450 4mm2									
		1		=Container:15/5,2	Not-Aus 1 emergency stop		=Container:15-XD51-1/BP-S	=Container:15-XD51-1	
Klemme, 3450 4mm2									
		2		=Container:15/5,2	Not-Aus 2 emergency stop		=Container:15-XD51-2/BP-S	=Container:15-XD51-2	
Klemme, 3450 4mm2									
		3		=Container:22/4,2	2AVDC SPS 3		=Container:22-XD51-3	=Container:22-4S2 :2	
Klemme, 3450 4mm2									
		4		=Container:22/4,3	OVDc SPS 4		=Container:22-XD51-4	=Container:22-4X4 :C	
Klemme, 3450 4mm2									
		5		=Container:32/3,2	2AVDC Fettpumpe P2.3 2AVDC grease pumps P2.3		+Con Material Container material container	+Con Material Container material container	-XS51 :5
Klemme, 3450 4mm2									
		6		=Container:32/3,2	OVDc Fettpumpe P2.3		+Con Material Container material container	=Container:32-3E2 :I2	
Klemme, 3450 4mm2									
		7		=Container:8/12,5	Wartungsschalter 7 maintenance switch		+BP/CP-S Bedienpult Schacht control panel shaft	+Con Material Container material container	-XS51 :7
Klemme, 3450 4mm2									
		8		=Container:13/1,7	Pilot Abbuwerkzeug 8 pilot cutting head		+BP/CP-S Bedienpult Schacht control panel shaft	+Con Material Container material container	-XS51 :8
Klemme, 3450 4mm2									
		9		=Container:22/4,3	Pilot Förderpumpe P2.1 9 pilot slurry pump P2.1		+BP/CP-S Bedienpult Schacht control panel shaft	=Container:22-XD51 :2	=Container:22-XD51-9
Klemme, 3450 4mm2									
		10		=Container:22/4,3	Pilot Förderpumpe P2.2 10 pilot slurry pump P2.2		+BP/CP-S Bedienpult Schacht control panel shaft	=Container:22-XD51 :D	=Container:22-XD51-10
Klemme, 3450 4mm2									
		11		=Container:15/5,3	Pilot Förderpumpe P2.3 11 pilot slurry pump P2.3			=Container:15-XD51-11	
Klemme, 3450 4mm2									
		12		=Container:15/5,3	Rohrbremse auf 12 open pipe brake			=Container:15-XD51-12	
Klemme, 3450 4mm2									
		13		=Container:15/5,3	Rohrbremse zu 13 close pipe brake			=Container:15-XD51-13	

Änderung Change	Datum date	Name name	Begr. checked

Ausdruck-Datum:
print-out-date
14.12.11



Herrenknecht AG
 Schädlerweg 2
 P.O. Box 2
 Tel.: 07924 30240
 Fax: 07924 3103

M-1642-C

Auftr.-Nr.: 102957
 Zeich.-Nr.:
 Order No.:
 drawing-no.: 3478-562-002

Bearb. Th name	Bearb. Th date	Bearb. Th date	Bearb. Th date

Weitergabe sowie Vervielfältigung dieses Dokuments, Verwertung und Mitteilung seines Inhalts sind verboten, soweit nicht ausdrücklich gestattet. Zuwiderhandlungen verpflichten zu Schadenersatz. Alle Rechte für den Fall der autorisierten, distribution und utilization of this document as well as the communication of its contents to others without express

ausdrücklich gestattet. Zuwiderhandlungen verpflichten zu Schadenersatz. Alle Rechte für den Fall der autorisierten, distribution und utilization of this document as well as the communication of its contents to others without express

Patent-, Gebrauchsmuster- oder Geschmacksmuster-Eintragung vorbehalten. of a patent, utility model or design.

Klemmenleiste Terminal Strip

-XD51 Schachtverbindung

+BP/CP-S Bedienpult Schacht control panel shaft

Leistenort Term.Strip Place

Klemmentyp Type of Terminal	Position position	Nr. No.	Brücken Bridges	Übersichts- cross reference	Verwendungszweck Application	Fluid	Innen inside	Verbindung Connection	außen outside
Kabel Cable									
Klemme, 3x450 4mm2									
		14		=Container:15/5:3	Telefon 14 telefone 14		=Container:15-XD51-14		
Klemme, 3x450 4mm2									
		15		=Container:15/5:3	Telefon 15 telefone 15		=Container:15-XD51-15		
Klemme, 3x450 4mm2									
		16		=Container:15/5:3	PE 16 PE 16		=Container:15-PE-BP/CP-S		=Container:15-XSS1-PE
Klemme, 3x450 4mm2									
		17		=Container:9/1:1	Profibus + Grün profibus + green		+BP/CP-S Bedienpult Schacht control panel shaft	=Container:9-1:102 :A1	=Container:9-A2-XD51
Klemme, 3x450 4mm2									
		18		=Container:9/1:1	Profibus - Gelb profibus - yellow		+BP/CP-S Bedienpult Schacht control panel shaft	=Container:9-1:102 :B1	=Container:9-B2-XD51
Klemme, 3x450 4mm2									
		19		=Container:9/1:1	Profibus Schirm Schirm profibus screen		+BP/CP-S Bedienpult Schacht control panel shaft	=Container:9-1:102 : :A1	=Container:9-SC2-XD51
Klemme, 3x450 4mm2									
		20		=Container:3x/4:3	Can Bus + Braun can bus + brown		+BP/CP-S Bedienpult Schacht control panel shaft	=Container:3x-4X3 : :	+Can Material Container material container
Klemme, 3x450 4mm2									
		21		=Container:3x/4:3	Can Bus - Weiß can bus - white		+BP/CP-S Bedienpult Schacht control panel shaft	=Container:3x-4X3 : :	-XSS1 :21
Klemme, 3x450 4mm2									
		22		=Container:3x/4:3	Can Bus Schirm Schirm can bus screen		+BP/CP-S Bedienpult Schacht control panel shaft	=Container:3x-4X3 : :	+Can Material Container material container
Klemme, 3x450 4mm2									
		23							
Klemme, 3x450 4mm2									
		24							

Änderung Change	Datum date	Name name	Begr. checked	Ausdruck-Datum print-out-date		Herrmann AG Schillerweg 2 D-70824 Stuttgart Tel.: 07142 302-0 Fax: 07142 3403
--------------------	---------------	--------------	------------------	----------------------------------	--	---

Auftr.-Nr. Order No.	102957	Bearb. Th name	Beit. 2
Zug.-Nr. drawing-no.	3478-562-002	Datum date	26.08.2011
	M-1642-C		

Weitergabe sowie Vervielfältigung dieses Dokuments, Verwertung und Mitteilung seines Inhalts sind verboten, soweit nicht ausdrücklich gestattet; Zuwiderhandlungen verpflichten zu Schadenersatz. Alle Rechte hier den Fall der Reproduktion, distribution und utilization of this document as well as the communication of its contents to others without express payment of damages. All rights reserved in the event of the grant of a patent, utility model or design.

Klemmenleiste Terminal Strip

-XS3

+ST-M

Leistenort
Term.Strip Place

Klemmen- Type of Terminal	Position position	Nr. No.	Brücken Bridges	Übersichts- cross reference	Verwendungszweck Application	Fluid Fluid	Innen inside	Verbindung Connection	außen
Kabel Cable									
Steckverbinder B oben		1			nach: To:				
Steckverbinder B oben		2							
Steckverbinder B oben		3							
Steckverbinder B oben		4							
Steckverbinder B oben		5		=Container:8/112	24VDC			+HV/+KDB Hauptverteilung main distribution board	-X03 :5
STECKERBUCHSE		6		=Container:8/112	Steuerstand in Container control cabin in container			+HV/+KDB Hauptverteilung main distribution board	-X03 :6
Steckverbinder B oben		7		=Container:8/5,4	24VDC SPS			+HV/+KDB Hauptverteilung main distribution board	-X03 :7
Steckverbinder B oben		8		=Container:8/5,5	0VDC SPS			+HV/+KDB Hauptverteilung main distribution board	-X03 :8
Steckverbinder B oben		9		=Container:8/5,6	24VDC			+HV/+KDB Hauptverteilung main distribution board	-X03 :9
Steckverbinder B oben		10		=Container:8/5,6	0VDC			+HV/+KDB Hauptverteilung main distribution board	-X03 :10
Steckverbinder B oben		11		=Container:8/5,7	24VDC			+HV/+KDB Hauptverteilung main distribution board	-X03 :11
Steckverbinder B oben		12		=Container:8/5,7	0VDC			+HV/+KDB Hauptverteilung main distribution board	-X03 :12
Steckverbinder B oben		13							

Änderung Change	Datum date	Name name	Begr. checked	Ausdruck-Datum printout-date		Hersteller Schäferweg 2 Tel.: 07824 302-0 Fax: 07824 3403
--------------------	---------------	--------------	------------------	---------------------------------	--	--

M-1642-C	Auftr.-Nr. Order No.	102957	Bearb. Th name	Bearb. Th date	Blatt page	1
	Zug.-Nr.: drawing-no.	3478-562-002				2

Weitergabe sowie Vervielfältigung dieses Dokuments, Verwertung und Mitteilung seines Inhalts sind verboten, soweit nicht ausdrücklich anders angegeben.
 The reproduction, distribution and utilization of this document as well as the communication of its contents to others without express

ausdrücklich gestattet. Zwischenhandlungen verpflichten zu Schadenersatz. Alle Rechte für den Fall der autorization is prohibited. Offenders will be held liable for the payment of damages. All rights reserved in the event of the grant

Patent-, Gebrauchsmuster- oder Geschmacksmuster-Eintragung vorbehalten.
 of a patent, utility model or design.

Klemmenleiste Terminal Strip

-XS3

+ST-M

Leistenort
Term.Strip Place

Kabel Cable	Klemmentyp Type of Terminal	Position position	Nr. No.	Brücken Bridges	Übersweis cross reference	Verwendungswerk Application	Fluid Fluid	Innen inside	Verbindung Connection	außen outside
	Steckverbinder B oben		14			nach: To:				
	Steckverbinder B oben		15							
	Steckverbinder B oben		16							
	Steckverbinder B oben		17		=Container:32/22	Profibus+ process data highway				+HV/MDB Hauptverteilung main distribution board -XD3 :17
	Steckverbinder B oben		18		=Container:32/22	Profibus- process data highway				+HV/MDB Hauptverteilung main distribution board -XD3 :18
	Steckverbinder B oben		19		=Container:32/22	Profibus Schirm				+HV/MDB Hauptverteilung main distribution board -XD3 :19
	Klemme 3x50 4mm ²		20							
	Klemme 3x50 4mm ²		21							
	Klemme 3x50 4mm ²		22							
	Klemme 3x50 4mm ²		23							
	Klemme 3x50 4mm ²		24							
	Steckverbinder B oben		PE		=Container:8/55					+HV/MDB Hauptverteilung main distribution board -XD3 :PE

Weitergabe sowie Vervielfältigung dieses Dokuments, Verwertung und Mitteilung seines Inhalts sind verboten, soweit nicht ausdrücklich gestattet. Zuwiderhandlungen verpflichten zu Schadenersatz. Alle Rechte hier den Fall der Reproduktion, distribution und utilization of this document as well as the communication of its contents to others without express

ausdrücklich gestattet. Zuwiderhandlungen verpflichten zu Schadenersatz. Alle Rechte hier den Fall der reproduction, distribution and utilization of this document as well as the communication of its contents to others without express

Patent-, Gebrauchsmuster- oder Geschmacksmuster-Eintragung vorbehalten. of a patent, utility model or design.

16016

Anforderung Gruppe	Datum	Name	Norm	Begr. checked	Ausdruck-Datum print-out-date	14.12.11		Hertenknecht AG Schäferweg 2 10020 Berlin Tel: 030 24 30240 Fax: 07824 3103	102957	3478-562-002	Bearb. Th name Datum: 26.02.2011	Blatt 2 -Haupt- +Neben-
--------------------	-------	------	------	---------------	-------------------------------	----------	---	---	--------	--------------	-------------------------------------	-------------------------------