

PLACA 1220/100 VISTA INFERIOR

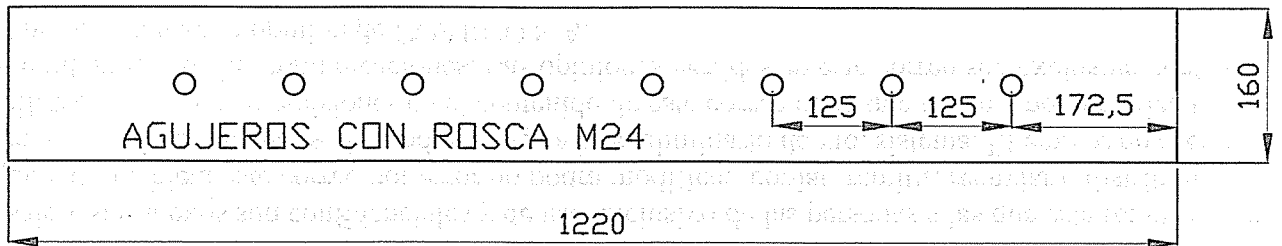

PLACA 1220/100 VISTA SUPERIOR

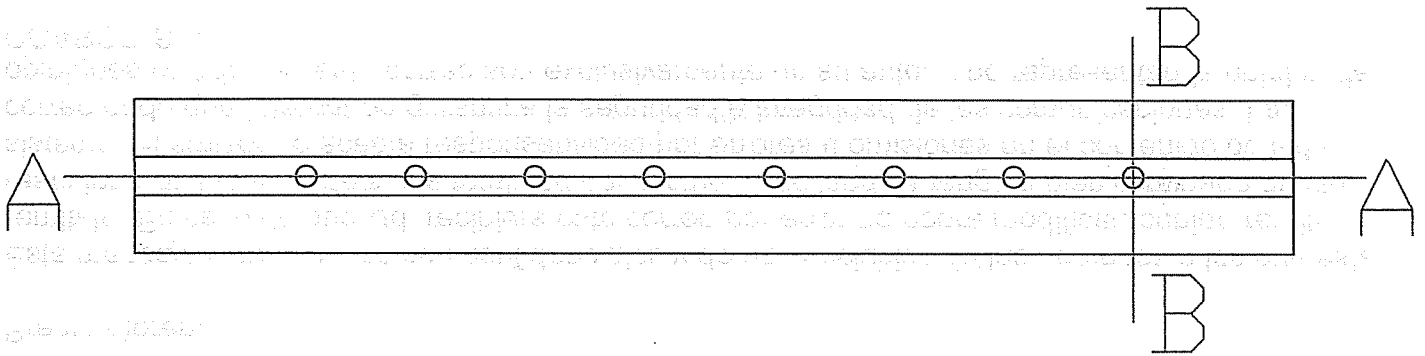

PLACA 1220/100 CORTE A-A

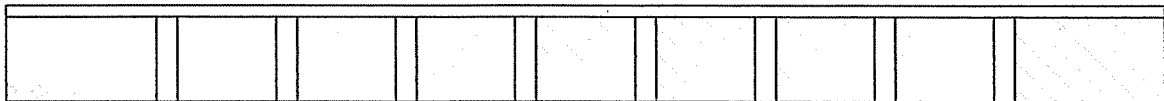

PLACA 1220/100 CORTE B-B

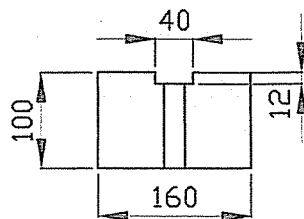

PLACA 1210/80-100 VISTA INFERIOR

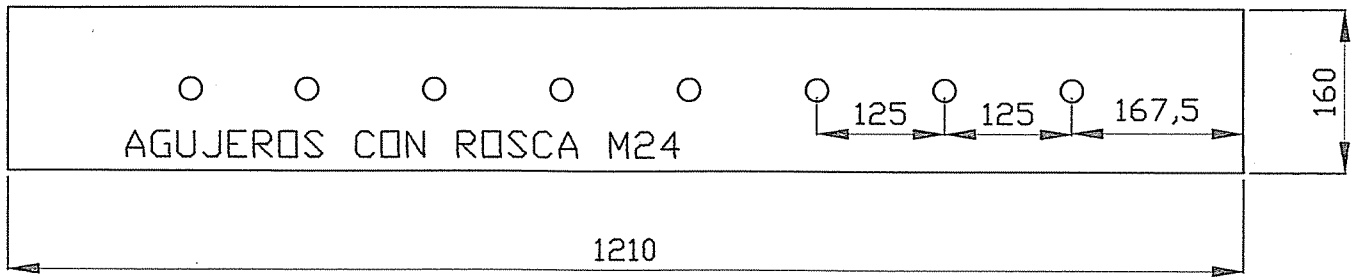

PLACA 1210/80-100 VISTA SUPERIOR

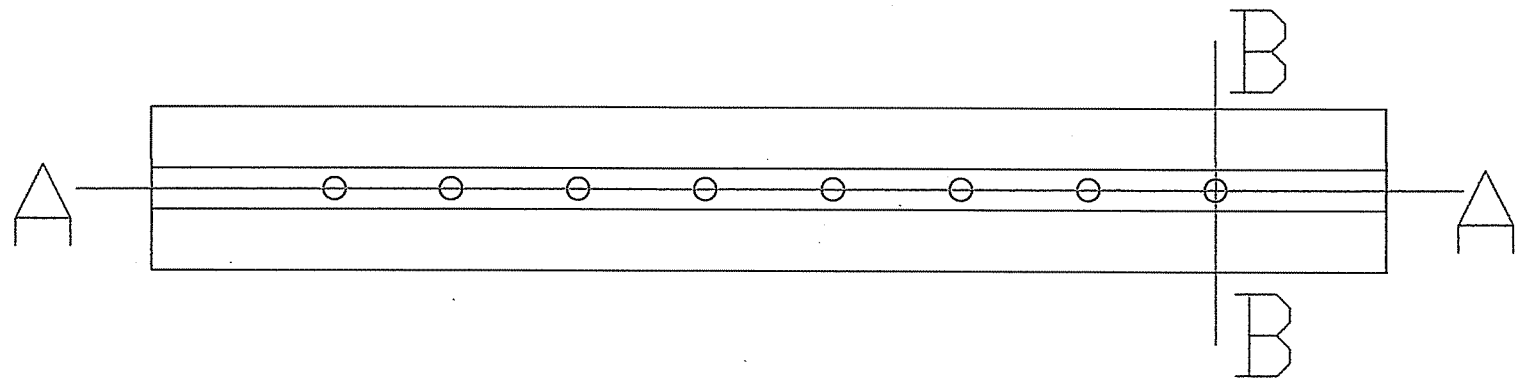

PLACA 1210/80-100 CORTE A-A



PLACA 1210/80-100 CORTE B-B

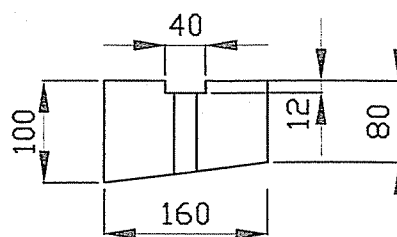

PLACA 1210/100 VISTA INFERIOR

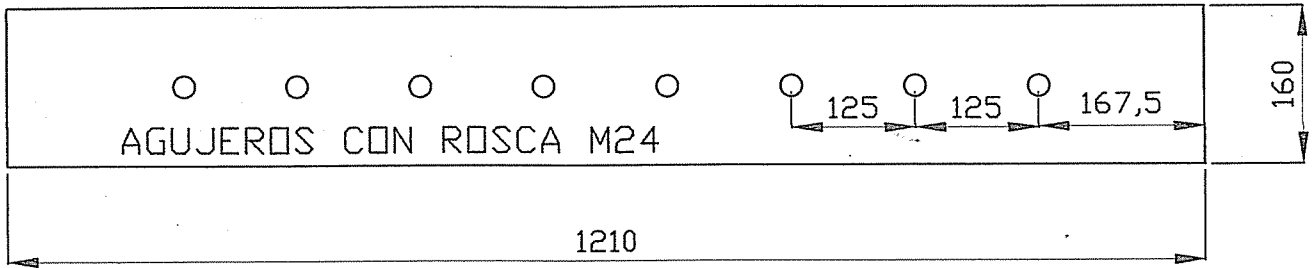

PLACA 1210/100 VISTA SUPERIOR

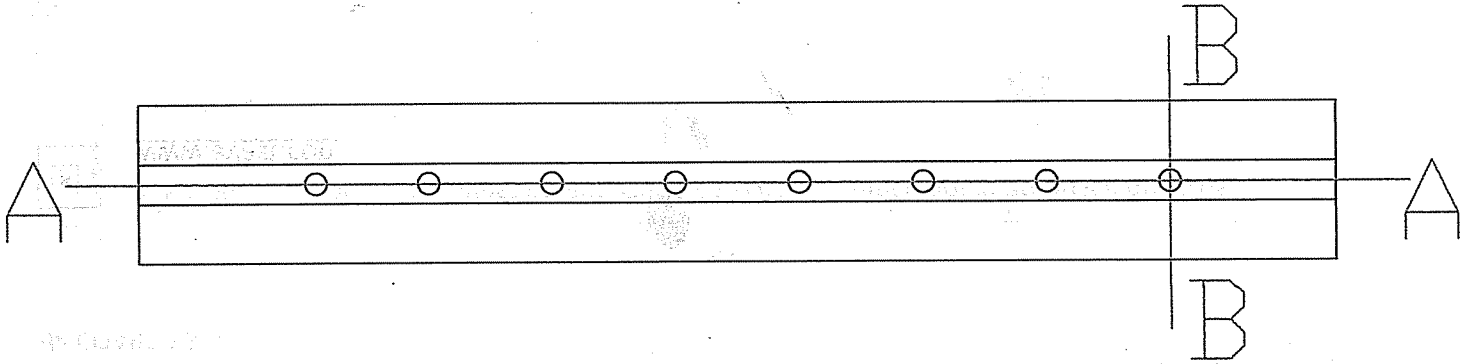

PLACA 1210/100 CORTE A-A

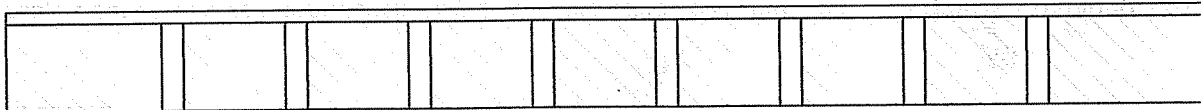

PLACA 1210/100 CORTE B-B

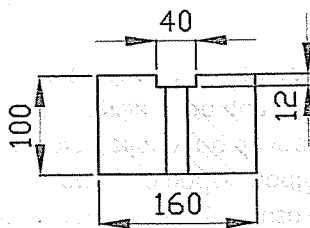

HC Pump 35
Acero inoxidable

CORAZAS DE IMPACTO SUPERIOR CHANC. DSB

NOTA: Esta son las medidas, de las perforaciones de las corazas

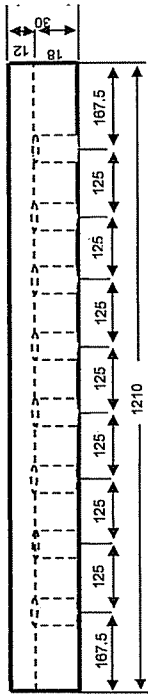

La coraza cuenta con 8 perforaciones, para la fijacion en base de chancadora que tienen una medida de 24 mm para cada perforacion con Hilo

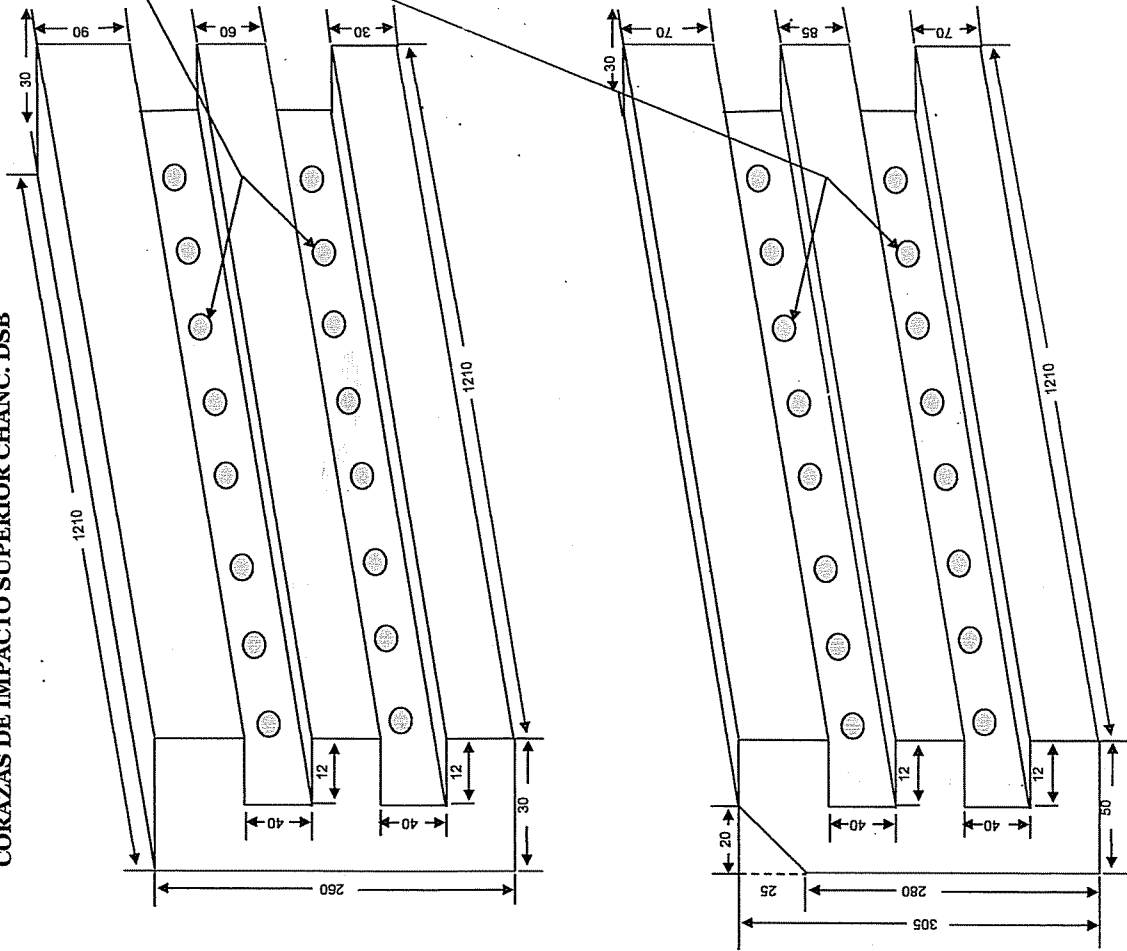

Chm/DS
eg



1220

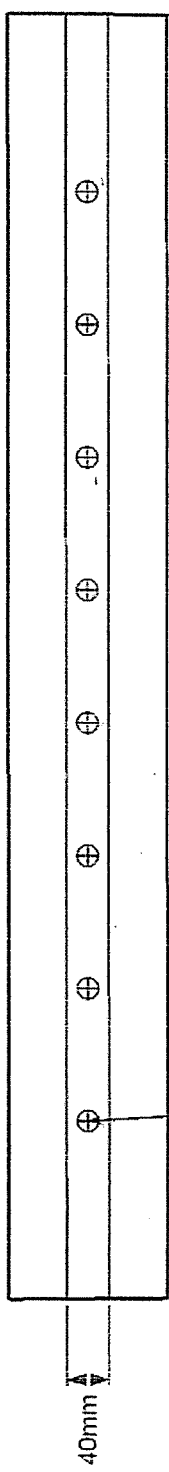
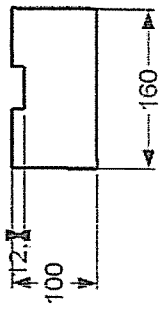
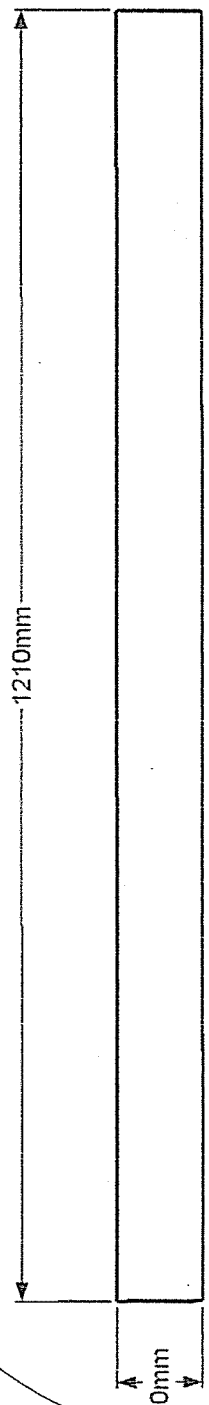

perforacion con hilo m24

Coraza impactora DSB