

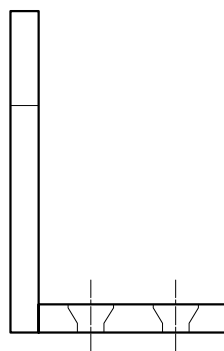

Vista en perfil, despues de soldar ambas placas



Cantidad: 24

Material: Acero 1010 ó 1045		Dibujante: Grün Javier Controló: Martínez Gastón		
Escala: 1:4	Tolerancia grals: ISO 2768-m	Rastrillo para cadena del elevador PL-15		

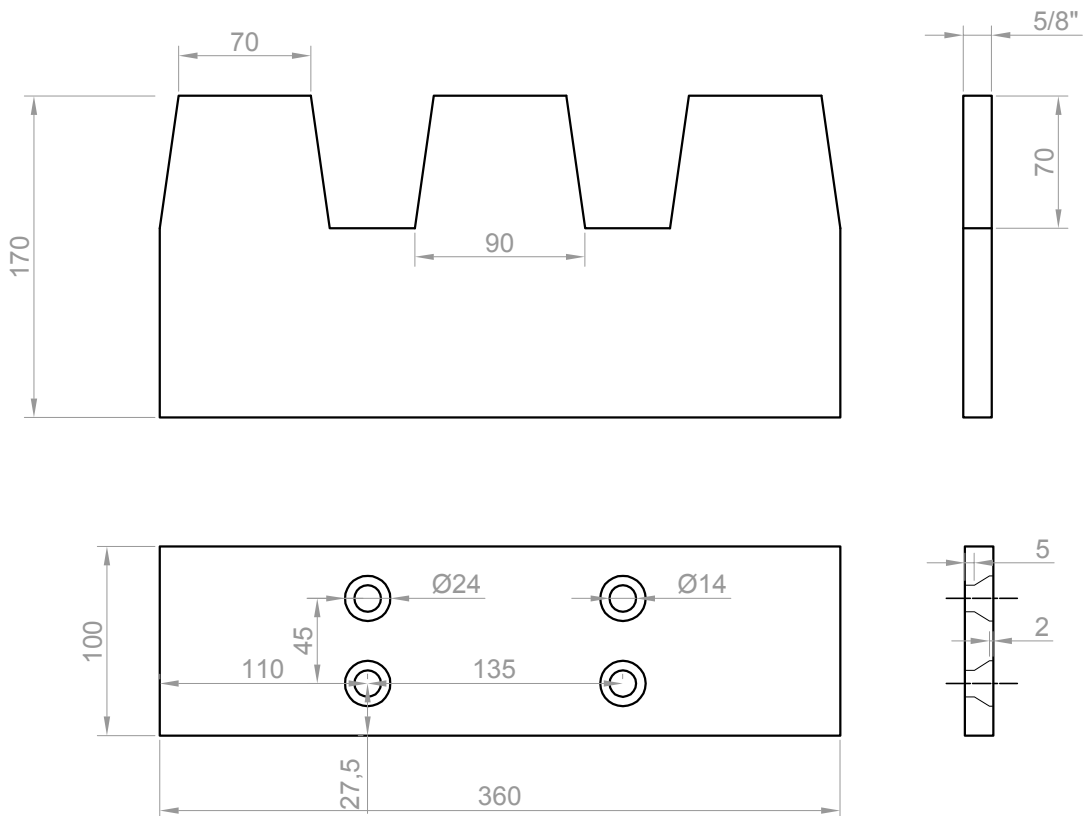

Vista en perfil, despues de soldar ambas placas



Cantidad: 24

Material: Acero 1010 ó 1045		Dibujante: Grün Javier Controló: Martínez Gastón		
Escala: 1:4	Tolerancia grals: ISO 2768-m	Rastrillo para cadena del elevador PL-15		

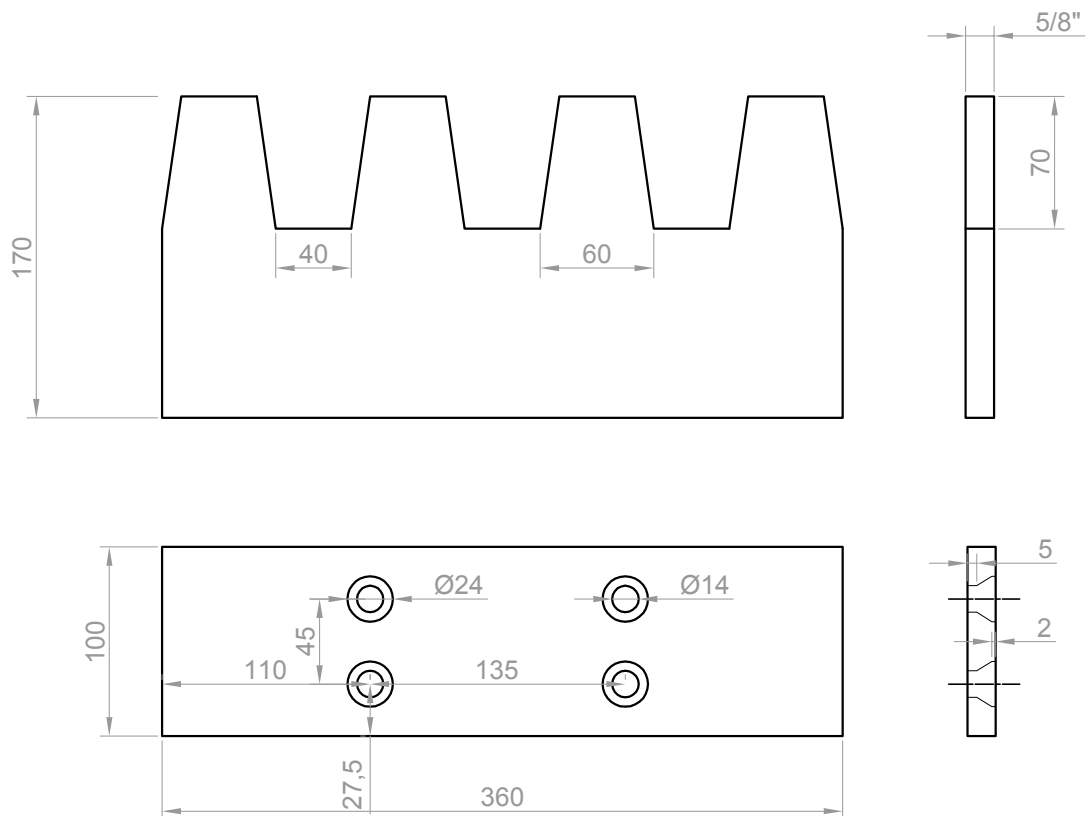

Vista en perfil, despues de soldar ambas placas

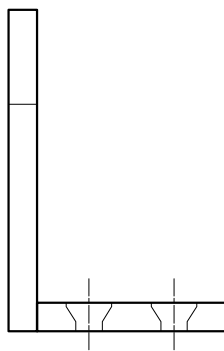

Cantidad: 24

Material: Acero 1010 ó 1045		Dibujante: Grün Javier Controló: Martínez Gastón		
Escala: 1:4	Tolerancia grals: ISO 2768-m	Rastrillo para cadena del elevador PL-15		