

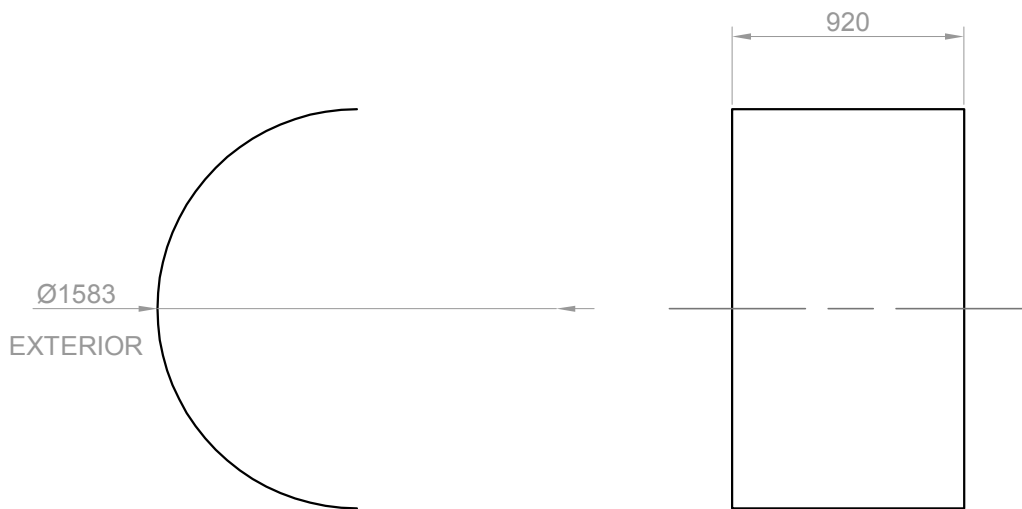

Chapa rolada, espesor de 5/16"

Material: Acero 1045	Cantidad: 2	Dibujante: Grün Javier	
		Controló: Martínez Gastón	
Escala: 1:30	Tolerancia grals: ISO 2768-m	Chapa interior 1 del horno PL-15	
		Hoja N°: 1/10	



Chapa rolada, espesor de 5/16"

Material: Acero Inoxidble	Cantidad: 2	Dibujante: Grün Javier			
		Controló: Martínez Gastón			
Escala: 1:30	Tolerancia grals: ISO 2768-m	Chapa interior 1 inoxidable del horno			Fecha: 11/09/14
		PL-15			Hoja N°: 2/10

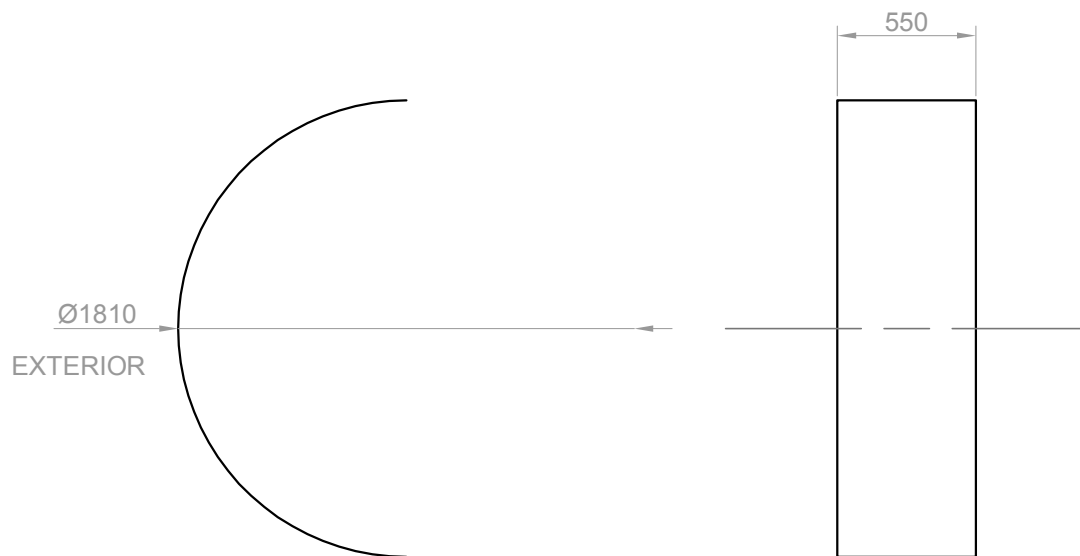

Chapa rolada, espesor de 5/16"

Material: Acero 1045	Cantidad: 2	Dibujante: Grün Javier	
		Controló: Martínez Gastón	
Escala: 1:30	Tolerancia grals: ISO 2768-m	Chapa interior 2 del horno PL-15	
		Hoja N°: 3/10	

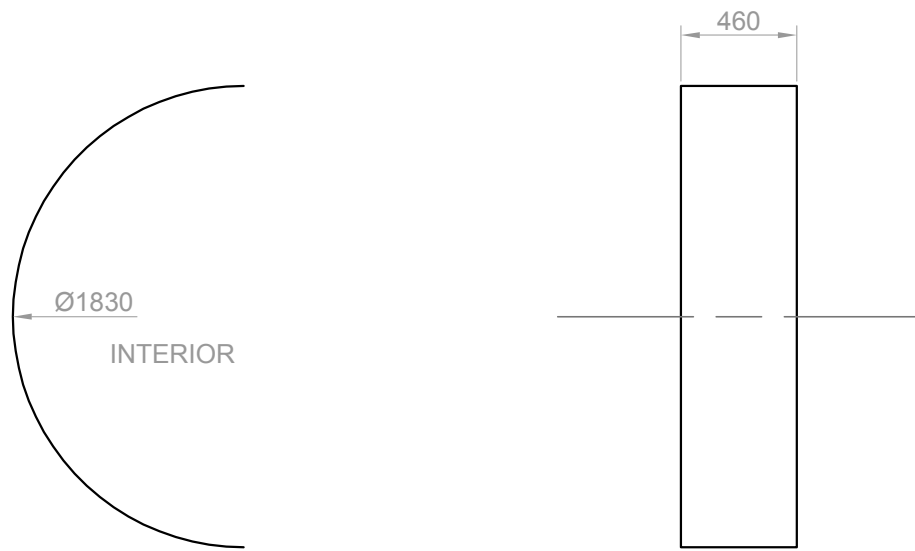

Chapa rolada, espesor de 3/8"

Material: Acero 1045	Cantidad: 2	Dibujante: Grün Javier	
		Controló: Martínez Gastón	
Escala: 1:30	Tolerancia grals: ISO 2768-m	Chapa exterior del horno PL-15	
		Hoja N°: 4/10	

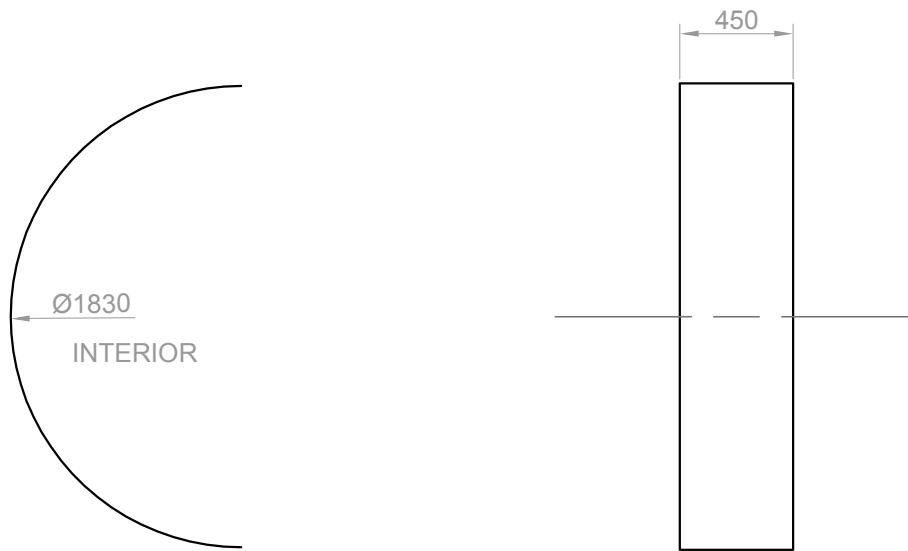

Chapa rolada, espesor de 3/8"

Material: Acero 1045	Cantidad: 2	Dibujante: Grün Javier	
		Controló: Martínez Gastón	
Escala: 1:30	Tolerancia grals: ISO 2768-m	Chapa exterior izquierda-secador del horno PL-15	Fecha: 11/09/14
			Hoja N°: 5/10

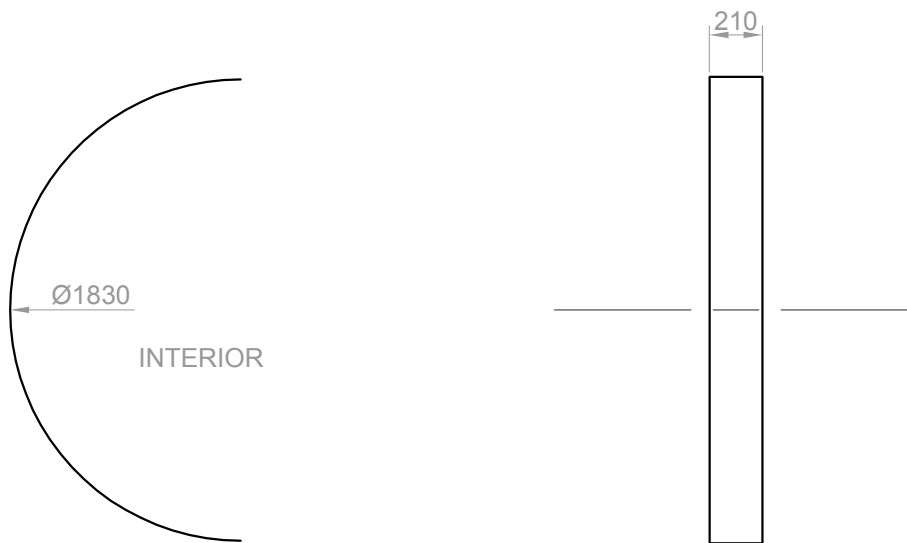

Chapa rolada, espesor de 3/8"

Material: Acero 1045	Cantidad: 2	Dibujante: Grün Javier	
		Controló: Martínez Gastón	
Escala: 1:30	Tolerancia grals: ISO 2768-m	Chapa exterior derecha-secador del horno PL-15	Fecha: 11/09/14
			Hoja N°: 6/10

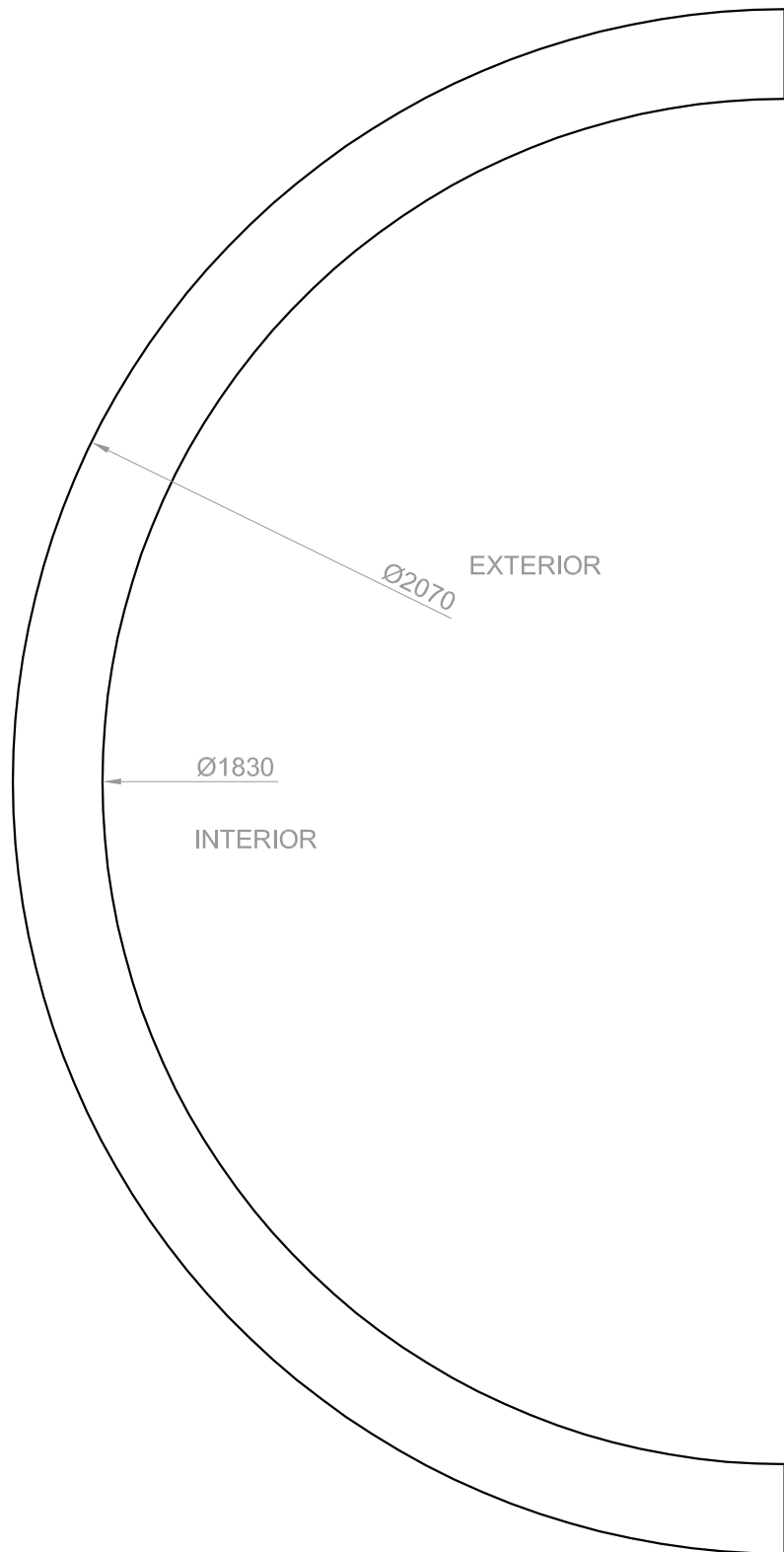

Chapa, espesor de $1/2''$

Material: Acero 1045	Cantidad: 2	Dibujante: Grün Javier	
		Controló: Martínez Gastón	
Escala: 1:30	Tolerancia grals: ISO 2768-m	Chapa para retener el material del horno PL-15	
			Fecha: 11/09/14 Hoja N°: 7/10

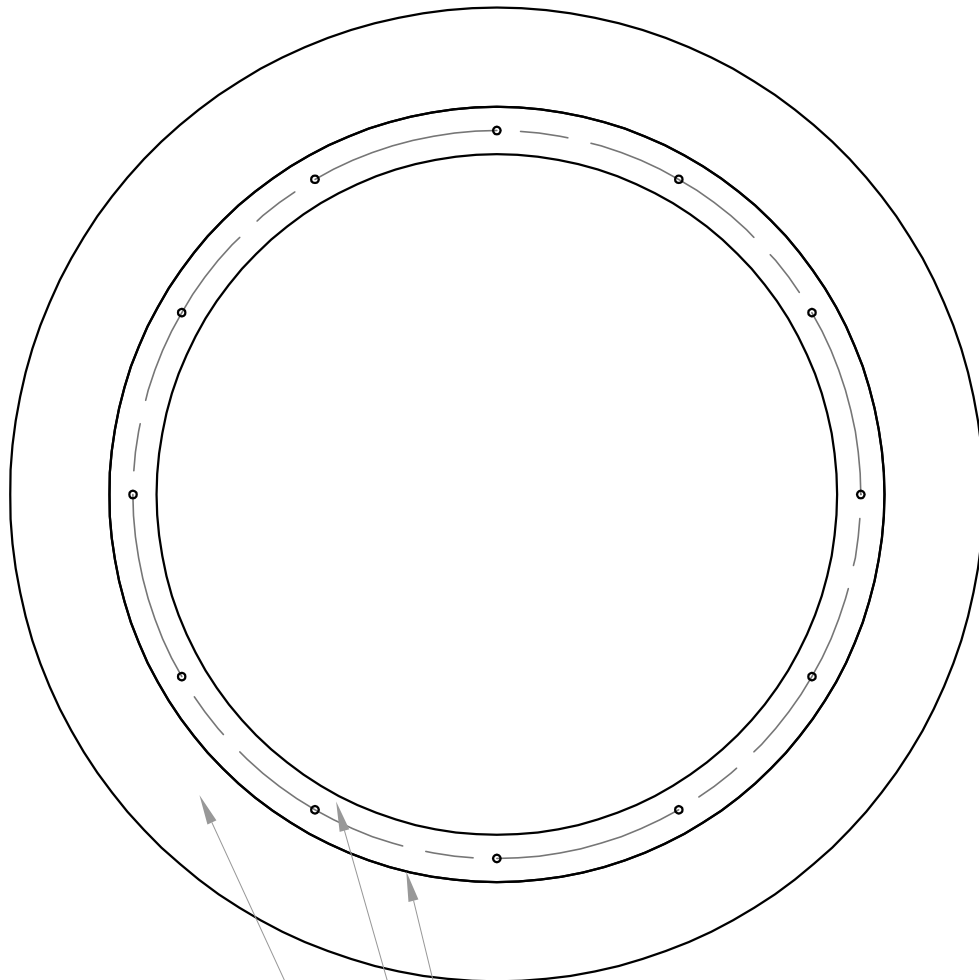

Soldar

Aro del deflector
(solo uno, ver plano 10)

Chapa cónica (ver plano 9)

Material:

Dibujante: Grün Javier

Controló: Martínez Gastón



Escala:
1:8

Tolerancia grals:
ISO 2768-m

Ensamble del deflector PL-15

Fecha: 11/09/14

Hoja N°: 8/10

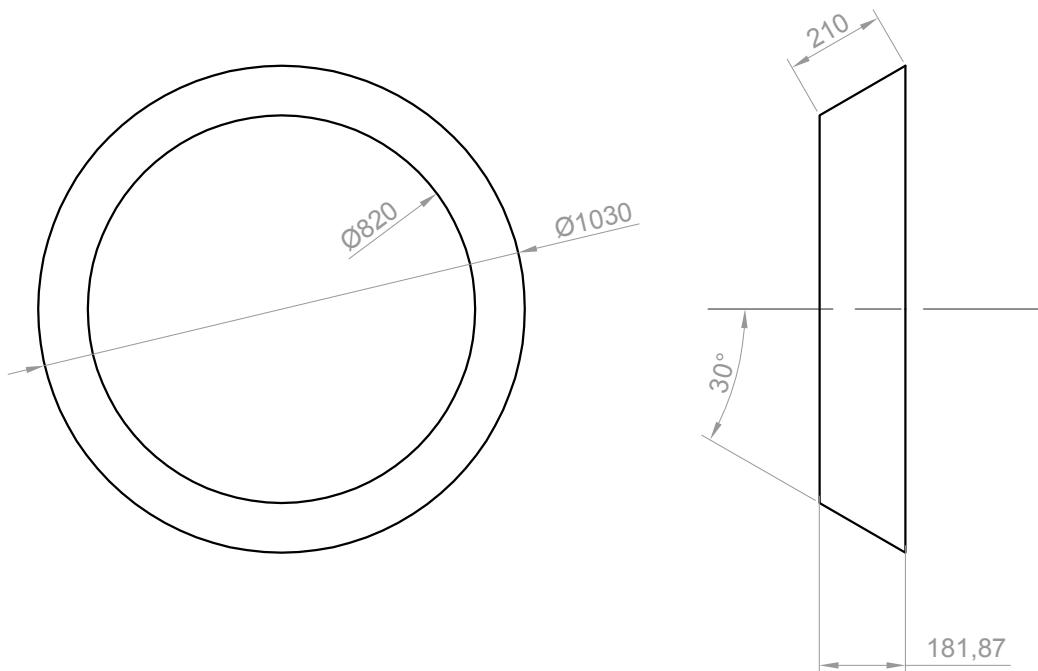

Espeor 5/16"

Material: Acero 1045		Dibujante: Grün Javier		
		Controló: Martínez Gastón		
Escala: 1:20	Tolerancia grals: ISO 2768-m	Chapa cónica del deflector PL-15		Fecha: 11/09/14
				Hoja N°: 9/10

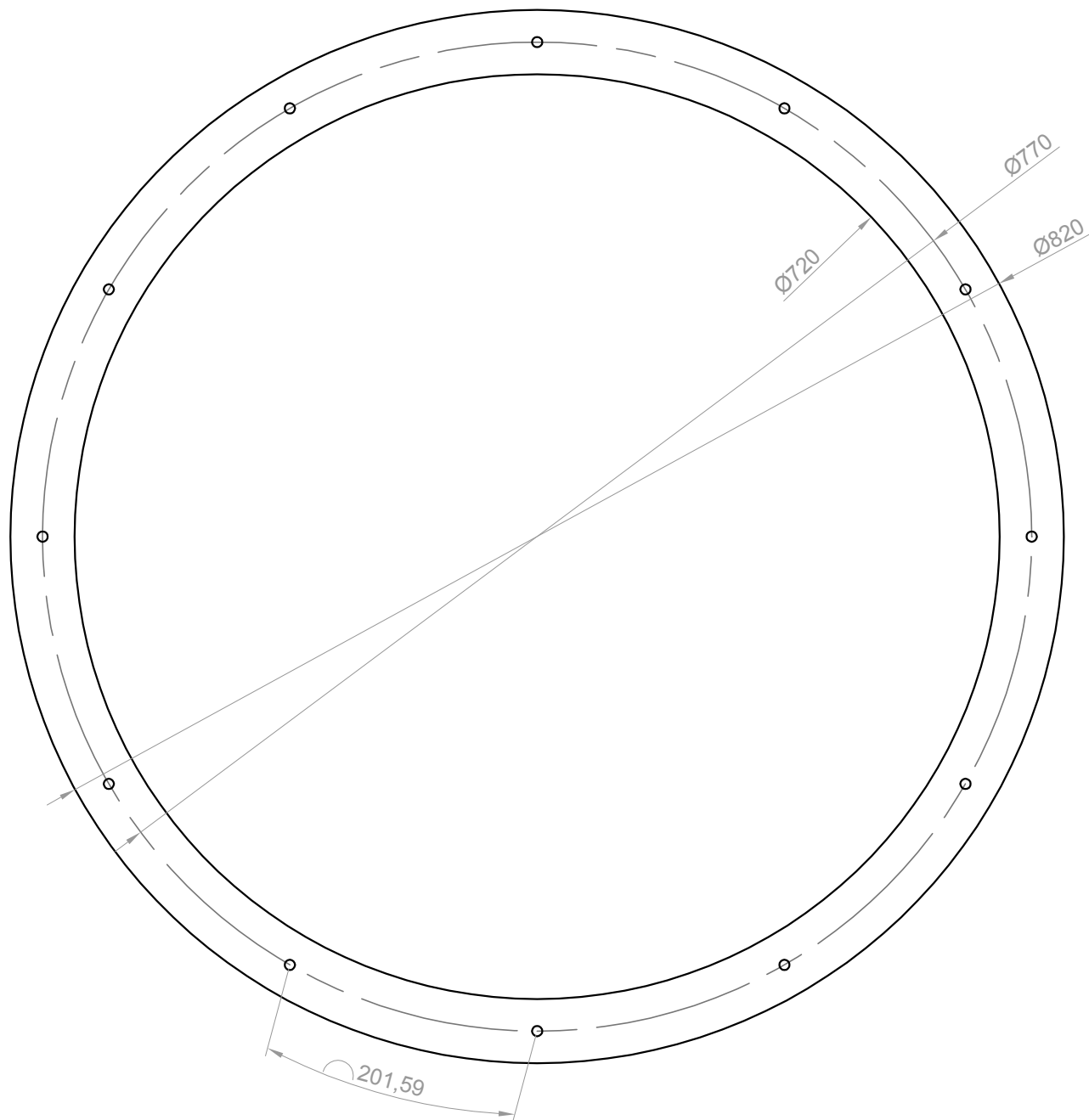

Espesor 3/8"
12 Agujeros para tornillo de 1/2"

Material: Acero 1045	Cantidad: 2	Dibujante: Grün Javier Controló: Martínez Gastón	
Escala: 1:5	Tolerancia grals: ISO 2768-m	Aro del deflector PL-15	