

SAFETY MANUAL 6



A guide for the prevention of accidents when driving, operating, cleaning, and maintaining concrete pumps, placing booms, and related equipment.



SCHWING

5900 Centerville Road
White Bear, MN 55127
ph: 651 429 0999
fax: 651 429 3464
www.schwing.com

Version 6.0.1

CALIFORNIA
Proposition 65 Warning

Diesel engine exhaust and some of its constituents are known to the State of California to cause cancer, birth defects, and other reproductive harm.

SAFETY MANUAL

S A F E T Y M A N U A L

A GUIDE FOR THE PREVENTION OF ACCIDENTS WHEN DRIVING, OPERATING, CLEANING, AND MAINTAINING CONCRETE PUMPS, PLACING BOOMS AND RELATED EQUIPMENT

Introduction

Safety is one of the major concerns of every person involved in the concrete pumping industry. Although much of the responsibility for everyday safety rests upon the pump operator, it is vital that everyone involved makes safety the top priority. This includes the owners, the mechanics, the ready mix drivers, the placing crew, the concrete contractors and the machine manufacturers.

Although this Safety Manual covers a great deal of information regarding the prevention of accidents while operating a concrete pump or placing boom, it is unlikely that every conceivable circumstance has been covered. Regardless of how thorough a manual like this may be, there is always the unexpected. Please understand that there is no substitute for **common sense** and dedication to the idea that **you are responsible for your own safety**, and affect

the safety of those around you. You have to know the rules first, but you must keep your mind on the job if knowledge of the rules is going to keep you and your co-workers out of harm's way. No attempt has been made in this Safety Manual to provide the highly specialized knowledge of the workings of the individual machines that is also critical for safe and proper operation. For that, you must **read and understand the operation manual for the machine(s) that you operate!**

This Safety Manual is a guide for the prevention of accidents and is to be used in conjunction with **professional training**. Additional information and materials are available through the American Concrete Pumping Association, including, specifically, an Operators Certification Program. Make the commitment to be professional - get your certification!

Version 6.0.1

July, 2008

© Copyright 1992, 1993, 1999, 2000, 2003, 2006, 2008
CPMA, All rights reserved.

SAFETY MANUAL

Table of Contents

Introduction	iii
General Rules	1
Table of Contents	1
I. Before You Leave The Yard	2
1. Safety Alert Symbol And Signal Word Explanation	2
2. What To Do Before You Arrive At Work	2
3. What To Check Before You Leave The Yard	5
4. Safety Rules For Driving Truck Mounted Concrete Pumps	9
5. Safety Rules For Towing Trailer Mounted Concrete Pumps	11
II. On The Job site	13
6. Safety Rules For Job Setup	13
7. Setting Up A Trailer Mounted Pump and/or A Separate Pipeline	29
III. Concrete Pump Operation.	34
8. Safety Rules For Pump Operators	34
IV. Cleaning The Pump And System	46
9. Safety Rules For Cleaning The Boom	46
10. Safety Rules For Cleaning The Concrete Valve & Hopper.	46
11. Safety Rules For Cleaning The Water Box	47
12. Safety Rules For Cleaning A Separately Laid Pipeline	48
V. Maintenance Of The Machinery	53
13. Safety Rules Regarding Inspection	53
14. Safety Rules Regarding Scheduled Maintenance	54
15. Safety Rules When Servicing The Machinery.	55
VI. Co-worker Safety	59
16. Safety Rules For Workers Assigned To The Pump.	59
17. Safety Rules For The Placing Crew.	66
Appendix	73
VII. Weld On Ends / Coupling Comparison	74
VIII. Minimum Pipe Wall Thickness Chart	75
IX. Glossary Of Terms.	76
X. Recommended Hand Signals	82
XI. Bibliography	82
Alphabetical Index.	83

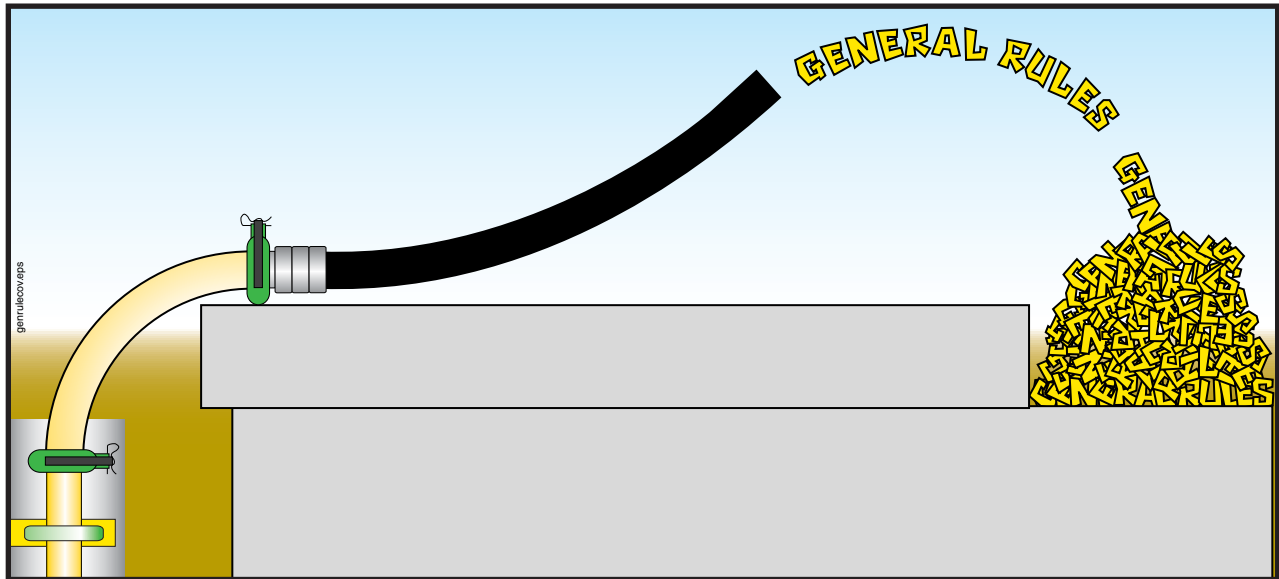

General Rules Table of Contents

I.	Before You Leave The Yard	2
1.	Safety Alert Symbol And Signal Word Explanation	2
2.	What To Do Before You Arrive At Work	2
3.	What To Check Before You Leave The Yard	5
4.	Safety Rules For Driving Truck Mounted Concrete Pumps	9
5.	Safety Rules For Towing Trailer Mounted Concrete Pumps	11
II.	On The Job site	13
6.	Safety Rules For Job Setup	13
7.	Setting Up A Trailer Mounted Pump and/or A Separate Pipeline	29
III.	Concrete Pump Operation	34
8.	Safety Rules For Pump Operators	34
IV.	Cleaning The Pump And System	46
9.	Safety Rules For Cleaning The Boom	46
10.	Safety Rules For Cleaning The Concrete Valve & Hopper	46
11.	Safety Rules For Cleaning The Water Box	47
12.	Safety Rules For Cleaning A Separately Laid Pipeline	48
V.	Maintenance Of The Machinery	53
13.	Safety Rules Regarding Inspection	53
14.	Safety Rules Regarding Scheduled Maintenance	54
15.	Safety Rules When Servicing The Machinery	55
VI.	Co-worker Safety	59
16.	Safety Rules For Workers Assigned To The Pump	59
17.	Safety Rules For The Placing Crew	66

I. Before You Leave The Yard

1. Safety Alert Symbol And Signal Word Explanation

1.1



The triangle with the exclamation point inside is used to alert you to an important safety point, and is called a *Safety Alert Symbol*. One of the following color-coded signal words will appear after the safety alert symbol:







or - without
the symbol:



is replaced
by:



- If the safety alert symbol is followed by the signal word **DANGER** with white letters in a red box (), it indicates a hazardous situation which, if not avoided, **WILL** lead to **death or serious injury**.
- If the safety alert symbol is followed by the signal word **WARNING** with black letters in an orange box (), it indicates a potentially hazardous situation which, if not avoided, **COULD** result in **death or serious injury**.
- If the safety alert symbol is followed by the signal word **CAUTION** with black letters in a yellow box (), it indicates a potentially hazardous situation which, if not avoided, **COULD** result in **minor to moderate injury**.
- The signal word **CAUTION**, used in a yellow box, but **without the safety alert symbol** (), means the point addresses a hazard which, if not avoided, **COULD** cause **damage to equipment or property**. See the note below.
- The signal word **NOTICE** is used when contact with the hazard could result in damage to equipment or property. As you can see, it does NOT make use of the Safety Alert Symbol.

Note: In days past, hazards with a consequence limited to property damage used the signal word ‘caution’ without the safety alert symbol on a yellow background, as shown above. The latest version of the standard that discusses these things (ANSI Z-535) has suggested that the word ‘notice’ be used instead, to avoid confusion between injury hazards and property damage hazards.

2. What To Do Before You Arrive At Work

- 2.1 Get enough sleep to be ready for the day’s work. Accidents can happen when the body is on the job, but the mind is not.
- 2.2 Arrive to work on time. Accidents can be caused by hurrying through procedures.

2.3

Dress in appropriate apparel and Personal Protective Equipment (P.P.E.) (see Figure 1). You should always wear these items when pumping concrete:

- hard hat
- safety glasses or goggles
- snug fitting clothes
- gloves
- steel toed shoes

In addition, you should wear:

- hearing protection while standing near the pump
- breathing mask when mixing slurry or whenever there is cement or other toxic dust in the air
- rubber gloves during cleanout
- rubber boots anytime you have to stand in concrete

* Breathing mask needed when cement dust (or other toxic dust) is present in the air.

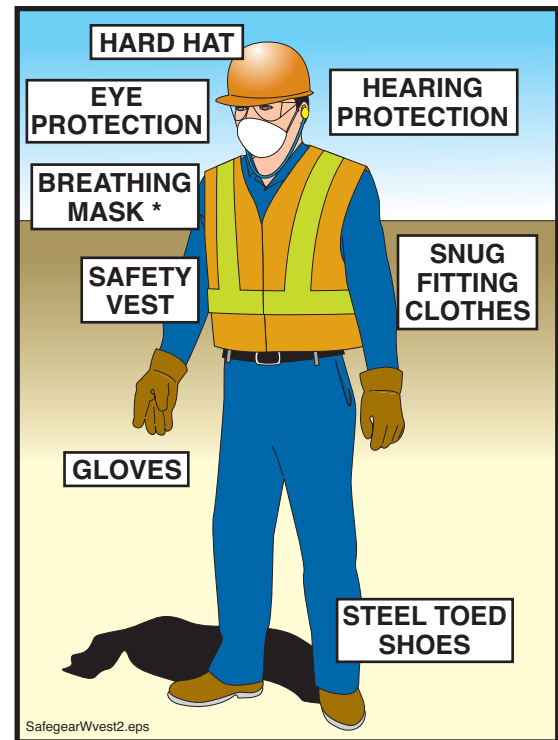

Figure 1
Personal Protective Equipment (P.P.E.)

2.4

Jewelry, athletic shoes, sandals, and shorts are examples of clothing that should NOT be worn when pumping.

SAFETY MANUAL

2.5

⚠ WARNING Be sure that any clothing you wear does not have strings, fringes, or other external tightening means that could be caught in moving parts (Figure 2).

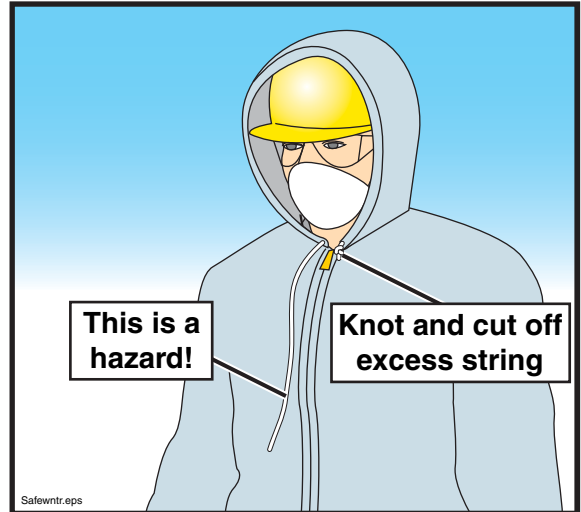

Figure 2
No strings attached

2.6

⚠ WARNING Never go to work on a construction site or work on, around or near a piece of machinery when under the influence of drugs or alcohol. Beware of prescription medications or “over the counter” drugs, many of which have specific warnings about operating machinery after taking the medication (Figure 3).

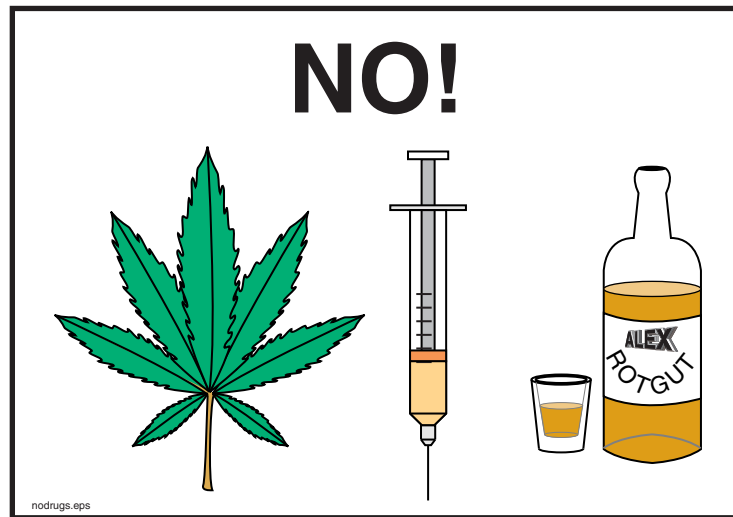

Figure 3
Your co-workers depend upon you for their safety

2.7

⚠ WARNING Don't bring your personal problems to work with you. In an office setting this may be annoying to co-workers, but on a construction site it can be deadly. The workers around you depend on you for their safety.

3. What To Check Before You Leave The Yard

3.1 **⚠ WARNING** Do not operate the machine until you read and understand the unit's operation manual. Lack of understanding of proper operating procedures could result in unsafe operation. Operation manuals are issued with each new unit. If you haven't seen it, ask your supervisor. Replacements are available from the manufacturer.

3.2 **⚠ WARNING** Inspect delivery pipes, concrete delivery hoses, and end hoses for wear. Never use a hose or pipe that is dented or worn out. **Know the maximum pressure that your machine can exert on the concrete, and be sure that the pipes, hoses and clamps are capable of handling the pressure.** Maximum pressure on concrete is stated in operation manuals, service manuals, and on the serial number plate of the machine. A chart showing the minimum wall thickness of pipeline versus maximum pressure is found on page 75 in the Appendix section of this Safety Manual.

3.3 **⚠ WARNING** If you will need to use compressed air to clean out the boom or system pipeline, BE SURE that you have the proper training, equipment, and attachments to do this procedure safely! Proper attachments include:

- A blow out head with properly sized air discharge regulator valve and separate water/air inlet. The two openings should be spaced apart far enough that a blowout ball could not cover both openings at once.
- A *go devil*, or a hard sponge ball. Regardless of which is used, it **must** fit into the pipeline tight enough that air cannot escape ahead of it.
- A ball or go devil catcher that will catch the go devil or ball when the line has been purged of all concrete, unless another method of controlling the outlet is used. There are two types of catchers (see paragraph 7.23 on page 33).
- A hose that is rated for the pressure of the air compressor you will use and that is able to connect with both the air compressor and the blow out head. The hose must be in good working condition and must be free of cracks, frays, tears or other damage. Do **NOT** improvise on this. **Make sure** that you have the right part (Figure 4).

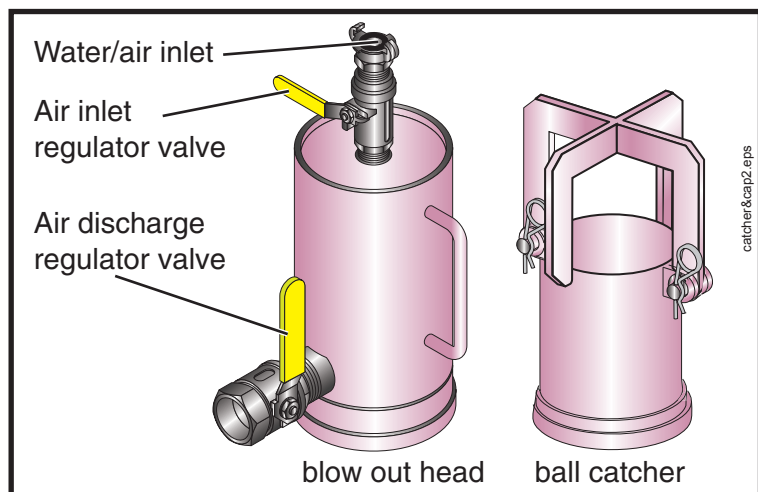

Figure 4
Compressed air accessories

SAFETY MANUAL

- 3.4 **⚠ WARNING** Be sure that the unit is equipped with all the pipes, clamps, gaskets and hoses, blow out adapters, ball catchers, and other accessories that you will need for the day's work. "Making do" with inappropriate equipment could cause accidents.
- 3.5 On trailer mounted units, check the oil and cooling system (air or water cooled systems) of the pump drive engine. Accidents could occur when lack of maintenance is causing a distraction while operating the equipment.
- 3.6 Be sure the battery has enough charge to start the pump drive engine. You will be rushed on the job if you have to do repair work before you can begin operation.
- 3.7 **⚠ WARNING** The operator is responsible for checking to see that the concrete pump, placing boom, and delivery system are in safe and proper working condition. If an unsafe condition exists, **work must not begin** until necessary repairs have been completed, or until the machine can be operated safely.
- 3.8 **⚠ WARNING** The operator is responsible for checking that all safety equipment and guards are in place and in good condition. If found to be missing, incomplete, or damaged, **work must not begin** until the situation has been made safe.
- 3.9 **⚠ WARNING** Inspect the tires and brakes on the truck. Never drive a truck with bald or cracked tires, or with weak or worn brakes. If you have air brakes, be sure that the air system is free from leaks and will maintain pressure when driving. Loss of air pressure will cause the brakes to be applied while driving. If driving continues after the brakes are applied, the resulting friction could cause enough heat to start a fire.
- 3.10 Drain moisture from the air tanks that supply the unit's brakes (if so equipped). This is especially important if weather conditions could cause the moisture to freeze. If you lose air pressure because of frozen moisture, the brakes will apply themselves, and you will have to stop driving until the unit is repaired.
- 3.11 **⚠ WARNING** Be sure that outriggers are pinned and locked before traveling. If the locking device is damaged or worn, it should be repaired immediately and the unit **must not be driven until the outriggers can be positively locked** against accidental opening (see Figure 5).

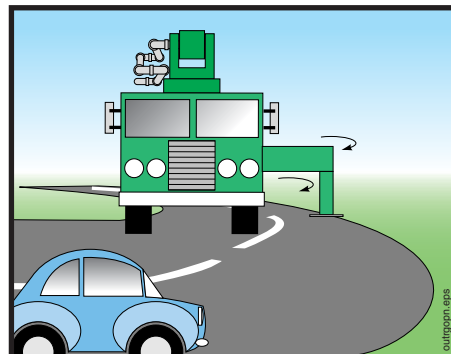

Figure 5
Before driving, be sure
outriggers cannot open

3.12 **⚠ WARNING** The operator is responsible for checking that all safety decals are in place and are in readable condition. If found to be missing or unreadable for any reason, steps should be taken to obtain replacements.

3.13 **⚠ WARNING** (See Figure 6.) Mount or dismount the pump or truck using the *3 Point Rule* (i.e. keep two hands and one foot or one hand and two feet in contact with a secure surface at ALL times).

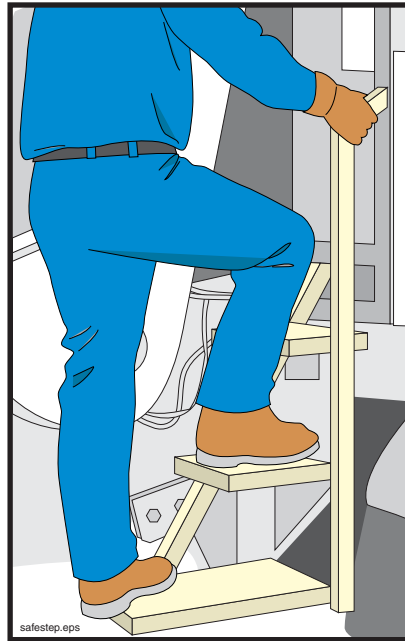

Figure 6
The 3 Point Rule

3.14 **⚠ WARNING** Never mount or dismount the truck or pump while carrying objects that prevent you from using the “3 Point Rule.” Move the objects separately, if needed.

3.15 **⚠ WARNING** Be sure there is nothing in the cab of the truck (such as empty soda cans, loose tools, etc.) that could interfere with the operation of the vehicle.

3.16 Be sure that all road-related safety devices (warning signs, flares, fire extinguisher, etc.) are present and secured for travel.

3.17 Be sure all personal protective equipment (hard hat, safety goggles, rubber gloves, etc.) are secured for travel.

3.18 **⚠ WARNING** Be sure the windshield and mirrors are clean and free of frost or ice, and that the mirrors are properly adjusted.

3.19 **⚠ WARNING** Verify that head lights, tail lights, turn signals, brake lights, backup warning horn, and backup lights are operational.

SAFETY MANUAL

3.20

In some cases you may be asked to operate a machine other than the one with which you are familiar. In these cases, be sure to:

- Know the weight, height, and width of the machine.
- Have a copy of the operation manual with you.
- Ask the machine's normal operator, the dispatcher, or your supervisor questions regarding any unusual or unique operational characteristics of the machine.
- Familiarize yourself with the machine by setting it up in the yard and running the functions, and by familiarizing yourself with the operation manual. This is especially important if the new machine is significantly different than the one you normally operate. Your co-workers depend on you to know the machine.

3.21

⚠ WARNING Before driving the unit, be sure the boom is securely in its cradle, resting on approved boom rests that are in good condition, and secured by the tie-down strap (if so equipped). On some makes and models, the boom can be damaged by the bouncing motion that occurs while driving, but this damage is easily avoided by using the strap (Figure 7).

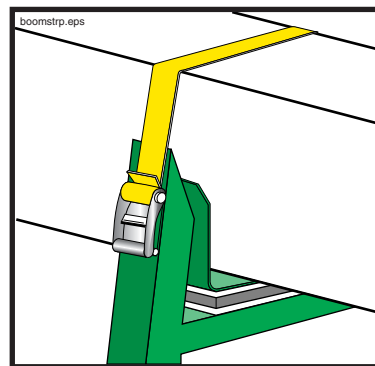

Figure 7

If your unit has a boom strap, use it

3.22

⚠ WARNING Be certain that all loose items on the unit are secured for travel before driving.

3.23

⚠ WARNING Emergency stop switches should be periodically checked by activating the switch in the yard and confirming that none of the machine functions operate electrically or manually.

4. Safety Rules For Driving Truck Mounted Concrete Pumps

4.1

⚠ DANGER **Electrocution hazard!** (See Figure 8.) If you're going to drive under low-hanging overhead power lines and it is not possible to maintain adequate safety distance between the pump and the wires, **you should look for another route!** If none is available, contact the power company responsible for the lines and have them de-energized.

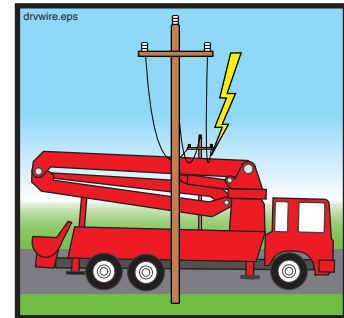

Figure 8
Watch for low-hanging power lines

4.2

Carefully select your route of travel. Avoid steep hills, residential areas, construction, low overpass clearances and narrow bridges whenever possible. **The driver is responsible for knowing the weight and height** of the machine.

4.3

⚠ WARNING **Collision/falling hazard!** Before driving on bridge or elevated roadways, **be sure that they can support the weight of the vehicle** (Figure 9).

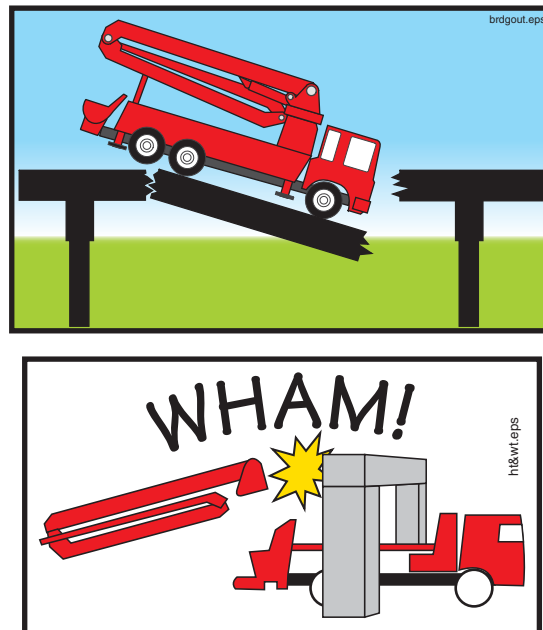

Figure 9
Know your height and weight

4.4

⚠ WARNING **Collision hazard!** Before driving under ANY structure, **BE SURE** that the machine will clear (Figure 9).

SAFETY MANUAL

- 4.5 **WARNING** **Explosion hazard!** Never refuel the unit near hot surfaces, sparks, or open flames (Figure 10).



Figure 10
Be careful when refueling

- 4.6 **WARNING** **Tipping hazard!** The vehicle must **not** be driven with an unfolded placing boom.

- 4.7 **WARNING** **Possible boom movement.** Before driving the unit be sure that the distribution gearcase (PTO) has **disconnected** the hydraulic pumps. **Driving with the hydraulic pumps engaged creates a hazard** and is destructive to the pumps.

- 4.8 **NOTICE** Never drive the unit with concrete in the hopper. Concrete could splash out and damage other cars or property, and the extra weight while driving could cause damage to the machine.

- 4.9 **WARNING** **Runaway truck hazard!** When going down a hill, use one gear lower going down than it would take to go up.

- 4.10 **WARNING** Truck mounted concrete pumps are generally top-heavy. Use caution when making sharp turns with the vehicle (Figure 11).

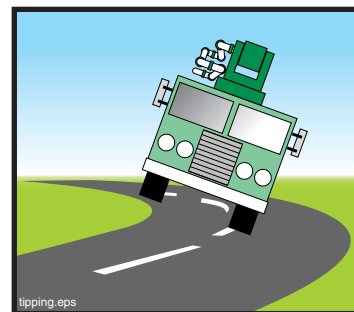

Figure 11
Maintain control on the curves

- 4.11 **WARNING** Slow down at intersections, near playgrounds, residential areas, and near schools. Children have no knowledge of the increased stopping distances required by heavy vehicles.

- 4.12 **CAUTION** Be familiar with your emergency equipment. Know how to light a flare, etc.

- 4.13 **⚠ WARNING** Drive defensively. You are at a distinct disadvantage when it comes to maneuverability and stopping distance.
- 4.14 **CAUTION!** If you must tow the unit, know the correct places to hook the towing cable(s). Improper towing can damage the vehicle or pump.
- 4.15 **⚠ WARNING** Never back up without a guide.
- 4.16 **⚠ CAUTION** Know the rules and laws that apply to your state and locality. They have been enacted for your protection and the protection of those around you.

5. Safety Rules For Towing Trailer Mounted Concrete Pumps

- 5.1 **⚠ WARNING** Be sure the towing vehicle is heavy enough and has enough horsepower and braking ability to tow the trailer. This is critical to maintaining control at highway speeds and to braking ability. If the trailer is heavier than the towing vehicle, braking distances will be greatly increased (Figure 12).

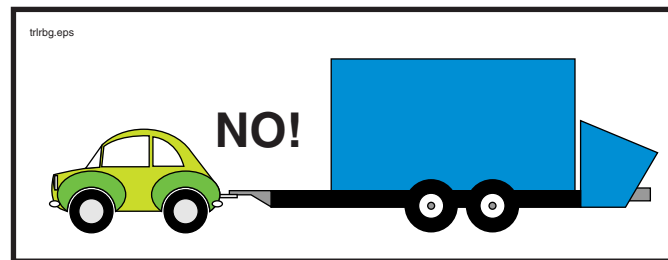





Figure 12
Do not under size the towing vehicle

- 5.2 **⚠ WARNING** Check the tires, tire pressure, and brakes on the trailer before towing. Never tow a vehicle with cracked or bald tires. A trailer tire blowout can cause loss of control in the towing vehicle.
- 5.3 **⚠ WARNING** Be especially careful on ice or slippery roads when towing a trailer. A skid that would normally be easily correctable can be multiplied by the trailer, causing loss of control.
- 5.4 **⚠ WARNING** Be sure that the electrical connections between the towing vehicle and the trailer are sturdy and reliable, and that the lights on the towing vehicle and trailer are working.
- 5.5 **⚠ WARNING** Always use safety chains and break-away protection when towing a trailer.
- 5.6 **⚠ CAUTION** Be aware of local or state regulations regarding mirrors and lights when towing a trailer.
- 5.7 **⚠ WARNING** When towing a trailer, your stopping distance and turning radius are greatly increased. Be aware of this **at all times**.

SAFETY MANUAL

- 5.8  **WARNING** When towing a trailer long distances, it is important to check the hitch, wiring, and safety chains frequently.
- 5.9  **WARNING** Be aware of your length when towing a trailer. A common cause of trailer accidents is turning too close to curbs or objects.
- 5.10  **WARNING** Never back up a trailer without a guide.
- 5.11  **WARNING** Frequently observe the trailer and watch for unusual swerving or indications of problems, such as a flat tire.

II. On The Job site

6. Safety Rules For Job Setup

SETTING UP A TRUCK MOUNTED BOOM PUMP

- 6.1 **The job setup phase can set the stage for accidents.** Taking a few extra moments to correctly set up the job will improve your chances of having a safe, trouble-free day.
- 6.2 **The operator is responsible for the safe operation of the machine.** Notify your employer, the job superintendent, and/or O.S.H.A. if you are being asked to set up in an unsafe manner. **You are never required to take a chance with safety.** You are the **only** person who can determine that the job circumstances under your control are safe.
- 6.3 **⚠ DANGER** When overhead wires are in the area that the boom will be moving to complete a pour, a spotter must be employed whose **only job is to warn the operator if the boom comes within 17 feet of the wires.** The spotter must understand the responsibilities assigned, and must be able to judge a 17 foot distance.
- 6.4 Some jurisdictions may have regulations that exceed the 17 foot rule. Government regulations always supersede this manual.
- 6.5 **⚠ DANGER** You **MUST** avoid hazardous proximity or contact with electric lines at all times! Position the machine so a minimum safety distance of **17 feet (5 meters)** is maintained in all boom positions needed to do the job (Figure 13). **Never decrease the safety distance to reach an unsafe area with the boom.**

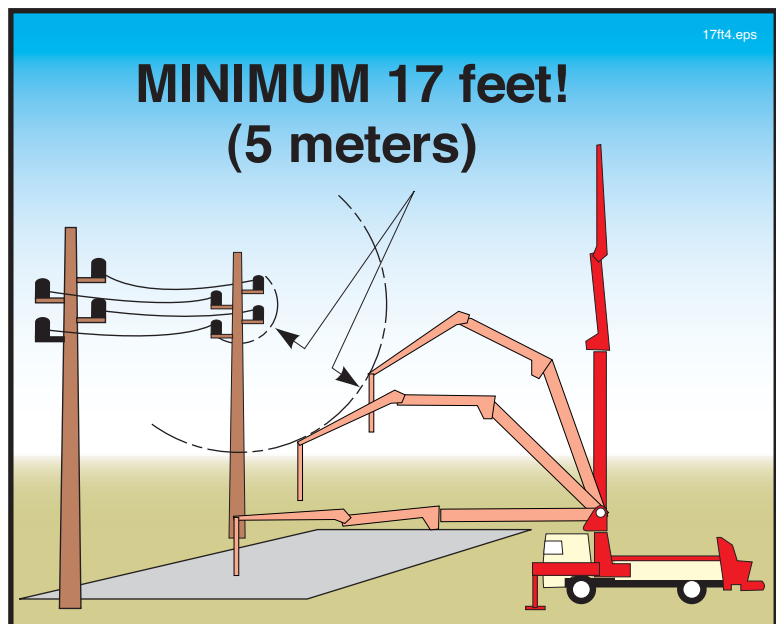

Figure 13
Always maintain the
17 foot rule

SAFETY MANUAL

6.6

⚠ DANGER If you are in doubt about your proximity to high voltage wires, or if it is not possible to maintain 17 feet of clearance, you must lay a separate pipeline or use a different placement method; otherwise do not do the pour. **Never take chances with high voltage!** (See Figure 14.)

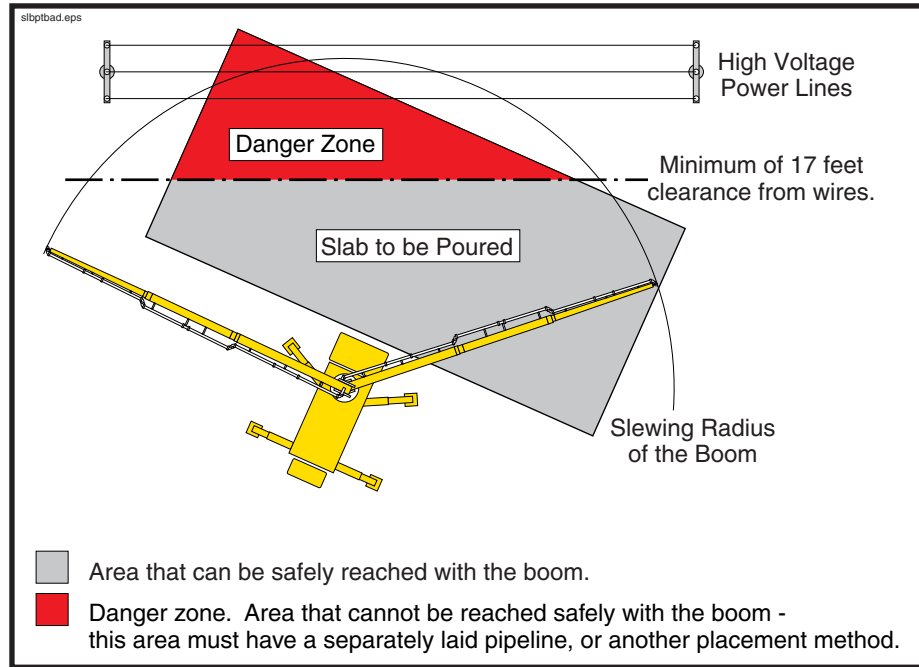

Figure 14
Lay a separate pipeline if you can't maintain the safety distance

6.7

⚠ DANGER Do not put the boom on top of electrical wires, even if you can maintain 17 feet of clearance. Mechanical or hydraulic malfunction may cause the boom to move down (Figure 15).

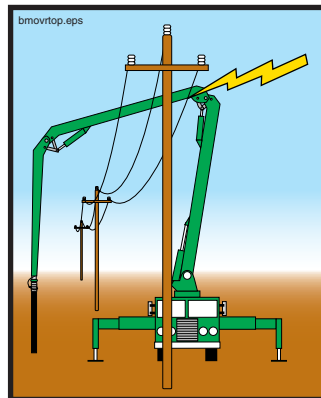
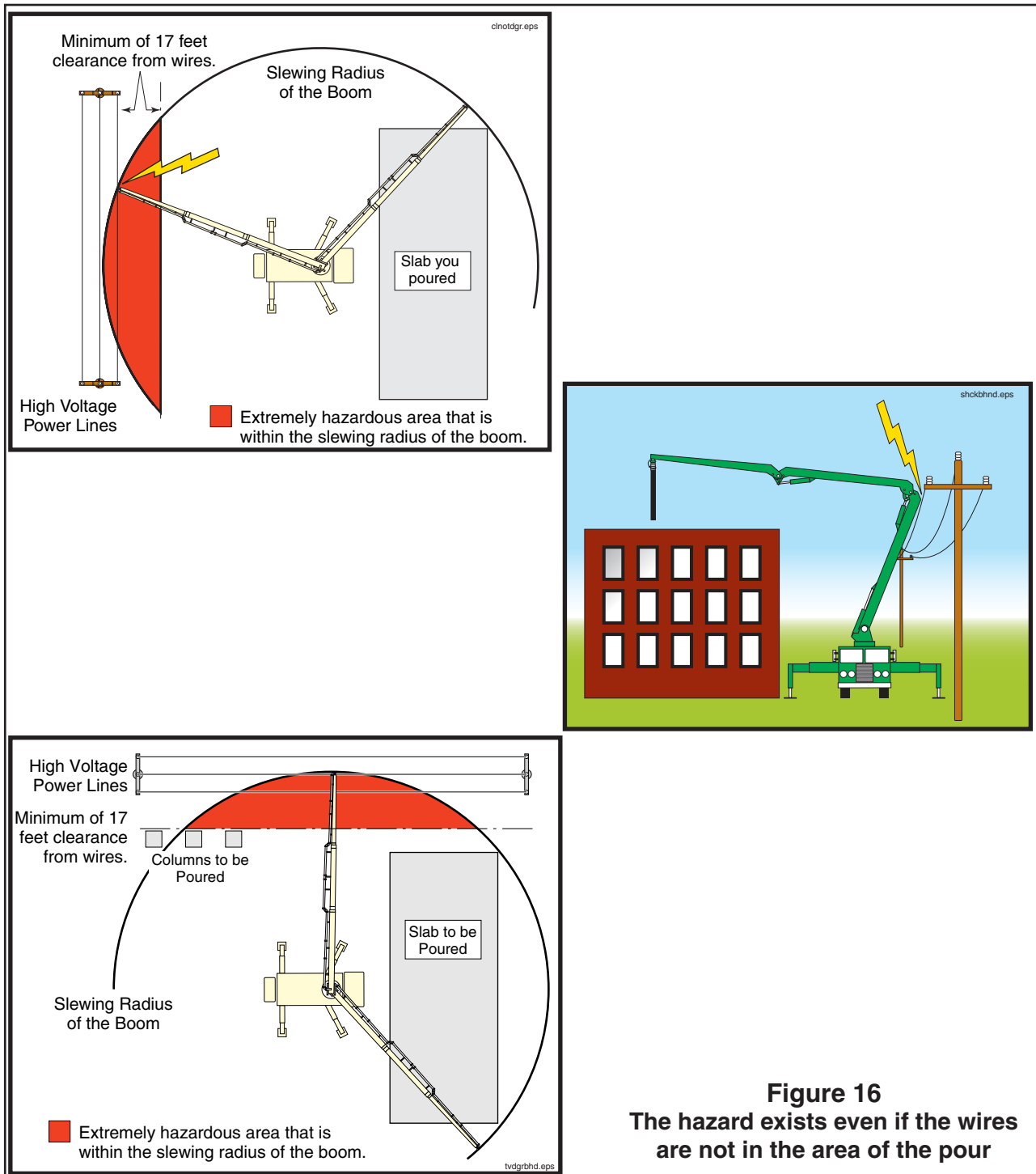

Figure 15
Never boom over wires

6.8

⚠ DANGER It is crucial to take electric wires into consideration during setup, even if they are away from the area to be pumped! Accidents occur during cleanout and moving that can be avoided by proper initial setup. In the illustrations below, the pour is outside of the minimum safety distance, but the danger still exists. You **must** be aware of the wires at all times! (See Figure 16.)



SAFETY MANUAL

6.9

⚠ DANGER Depth perception varies from person to person and is affected by the distance from the objects being observed. Minimum distances from electrical wires and other obstructions during setup should always be judged by placing yourself in a viewing position that does not require depth perception judgements. If this is not possible, a spotter **must** be used! See the glossary for the definition of spotter (Figure 17).

Will it hit the wires?
You can't tell from here.

Get the best possible vantage point

From the vantage point of this operator, it would be extremely difficult to tell if the end of the boom will contact the wires.

During setup, the operator should stand in this position. If this is not possible, a spotter **MUST** be used. **DO NOT RELY ON DEPTH PERCEPTION WITH HIGH VOLTAGE WIRES!**

Figure 17
Never rely on depth perception with electric wires

6.10

⚠ DANGER Always assume that a power line is live. Never take the word of someone on the job site that it has been de-energized. **Only a qualified representative of the responsible power company can verify that a line has been de-energized** (see Figure 18).

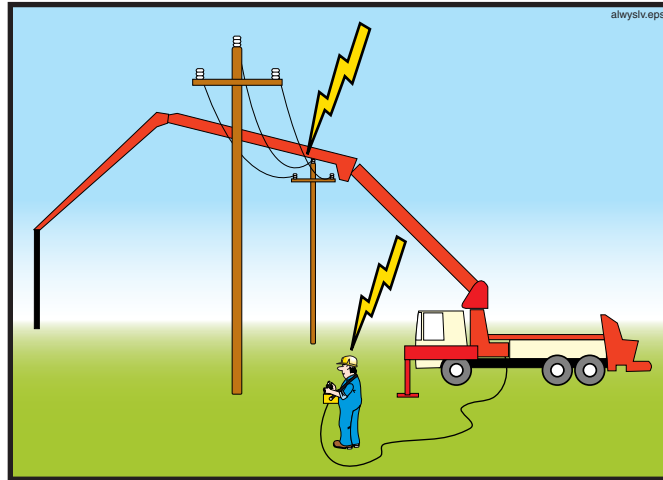

Figure 18
Assume the wires are energized

6.11

⚠ WARNING Maintain a safe distance from obstructions, such as cranes, scaffolding, and buildings (Figure 19).

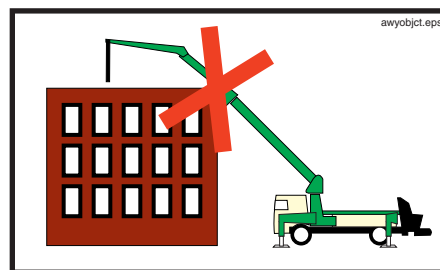

Figure 19
Maintain a safe distance from obstructions

6.12

⚠ WARNING Place wheel chocks under the tires on sloping terrain. Release the brakes and allow the machine to settle against the chocks, then reapply the brakes.

6.13

⚠ CAUTION Remove any snow, ice, oil, or dirt from steps and platforms. In very cold temperatures, a little concrete placed on platforms will freeze, give traction during the pour, and be easily removed when thawed.

SAFETY MANUAL

6.14

⚠ WARNING Possible boom damage and tipping hazard! Never exceed the manufacturer's rated weight limit for the placing boom! If continuation pipes are connected to the end hose, they must **NOT** impose any additional load on the boom (Figure 20).

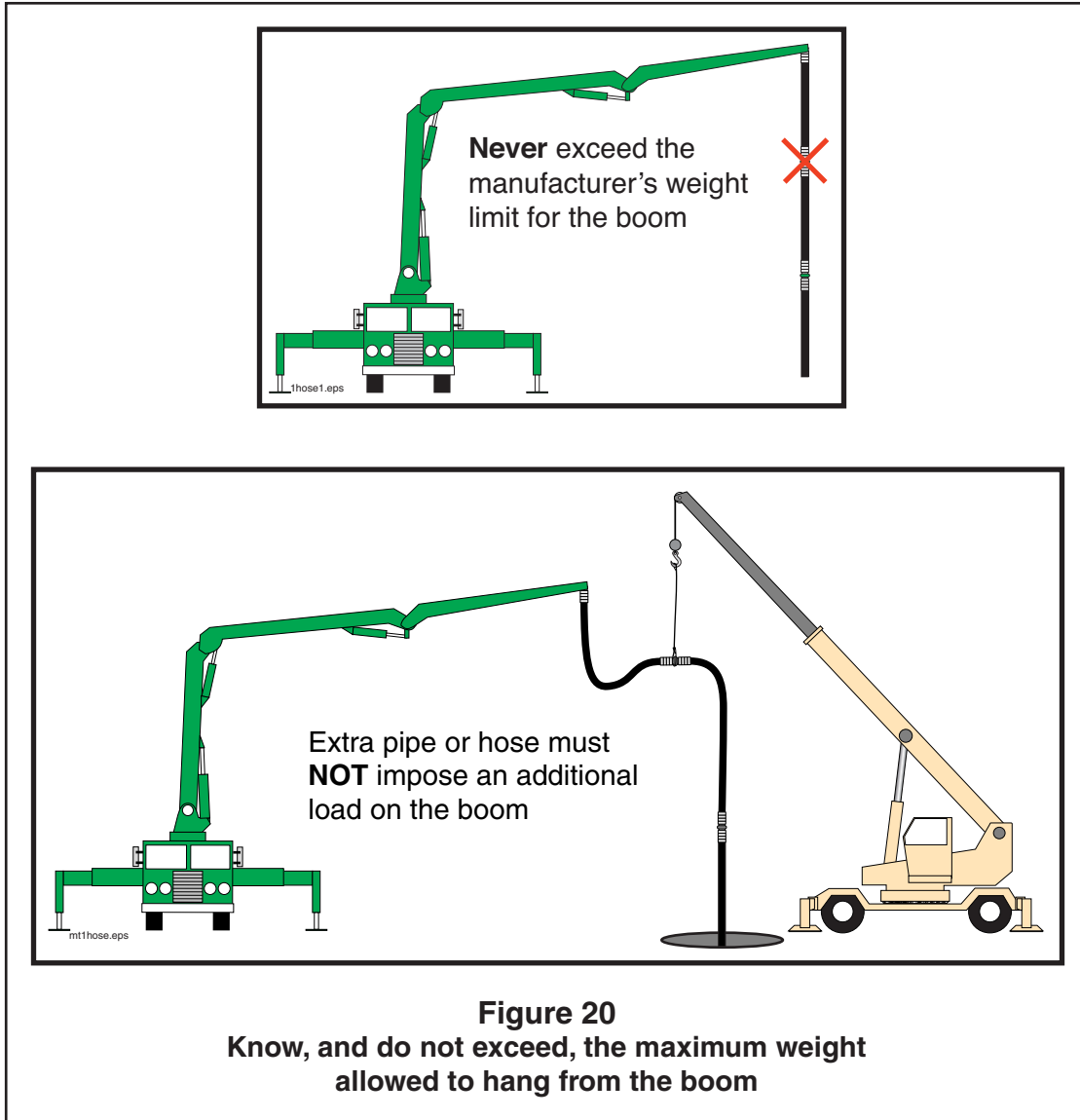

6.15

⚠ WARNING The length of a 125mm boom end hose may not exceed 13 feet (4 meters). Certain machines may require a shorter length or smaller diameter end hose. Check with the boom manufacturer.

6.16

⚠ WARNING Possible structural damage. If you remove the supplied tip hose and replace it with a combination of reducers and hoses, the total weight of all hanging pieces (including the weight of the concrete) must not exceed the weight

of the supplied tip hose (including concrete). As an example, a 12 feet long, 125mm (or 5 inch) diameter end hose, when filled with normal, hard rock concrete weighs 376 pounds. Certain units may have a lower allowable weight and, thus, a different tip hose. The operation manual included with the unit, and/or a decal on the end of the boom will inform you of the specification. It is the operator's duty to know the specification of the unit in operation (Figure 21). If needed, contact the manufacturer. **Find out if your unit has special requirements!**

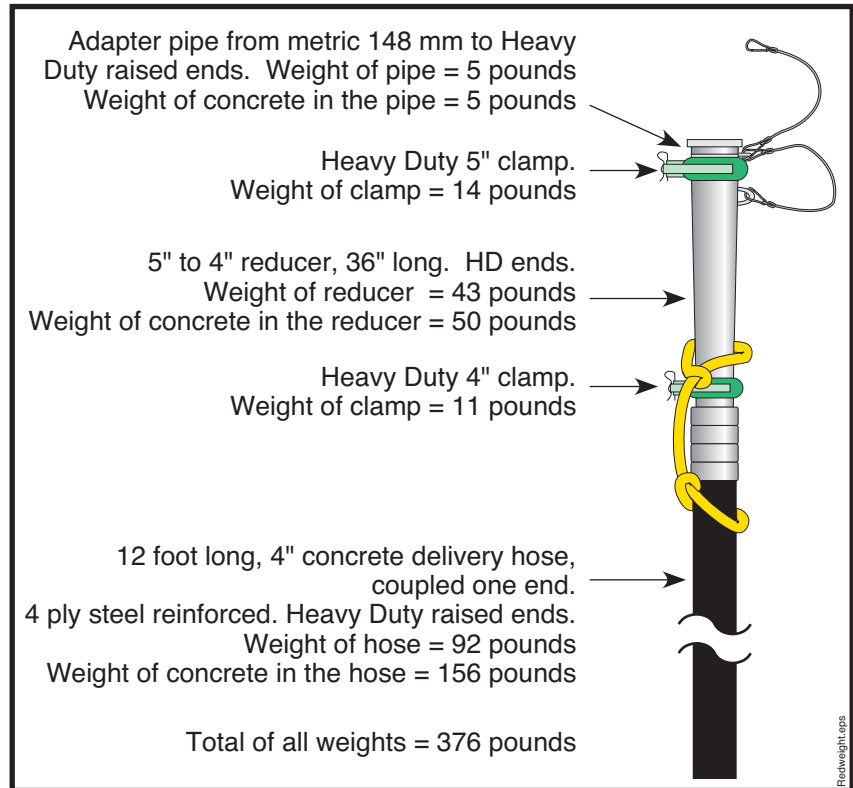

Figure 21
An example reducer/hose combination

6.17

⚠ WARNING A *concrete delivery hose* is a flexible concrete hose that has two end couplings. An *end hose* is a flexible concrete hose that has one end coupling (see Figure 22). In normal usage, it is preferable to have an end hose as the last piece of delivery system. If you will be swinging the full boom over workers or property you must be able to plug the delivery system. See the instructions for plugging the delivery hose on page 45.

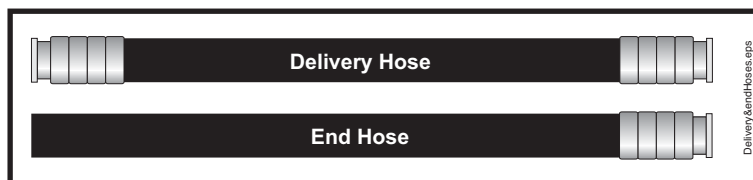
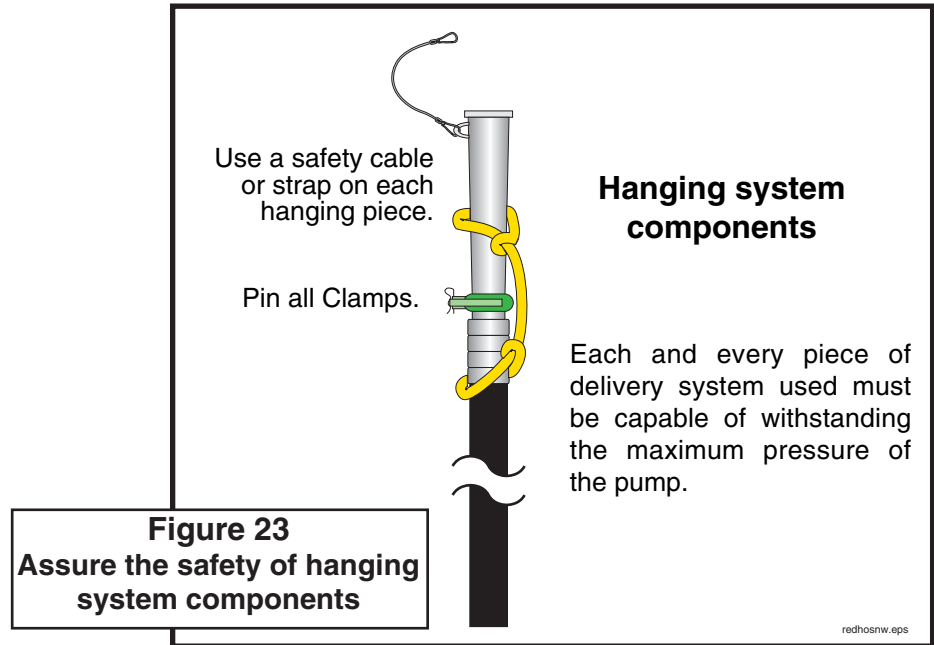

Figure 22
Delivery Hose and End Hose

SAFETY MANUAL

6.18

⚠ WARNING All hanging system components must be fastened with safety cables or straps, and **each component must be capable of handling the maximum concrete pressure of the machine** (see Figure 23).



6.19

⚠ WARNING Placing booms possess a very wide effective operating range. Due to this high degree of mobility, some placing booms can reach a position unsuitable for practical operation. Under certain circumstances **overloading, tipping, or damage to the boom is possible**. These unsuitable areas are documented on safety decals and in operation manuals (see Figure 24). **Be aware of these areas if they apply to your unit and set up the pump taking these areas into consideration.**

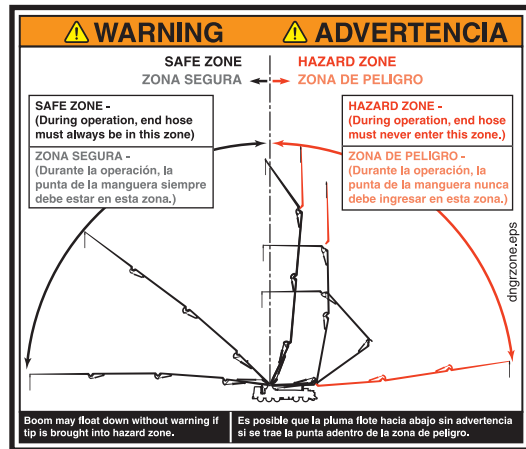

6.20

⚠ WARNING Collision hazard! Secure the immediate area of the machine from public traffic in accordance with all applicable regulations (warning lights, safety cones, barricades with flashers, etc.).

6.21 **⚠ WARNING** Consider the safe approach and departure of the ready-mix trucks and adjust your setup accordingly. Adjusting your setup position by a few degrees one way or another could mean the difference between a safe approach and an unsafe approach. Some examples of unsafe approaches are: too near an excavation or sticking out into traffic.

6.22 **⚠ WARNING** If you set up the unit with one or more outriggers not fully extended on the side away from the pour (shortrigging), you will tip the machine if you forget and rotate the boom over the side with the unextended outriggers. That being said, it is known that under certain circumstances, shortrigging is unavoidable (see Figure 25). If no alternatives are practical and you must shortrig for a particular job, keep these points in mind.

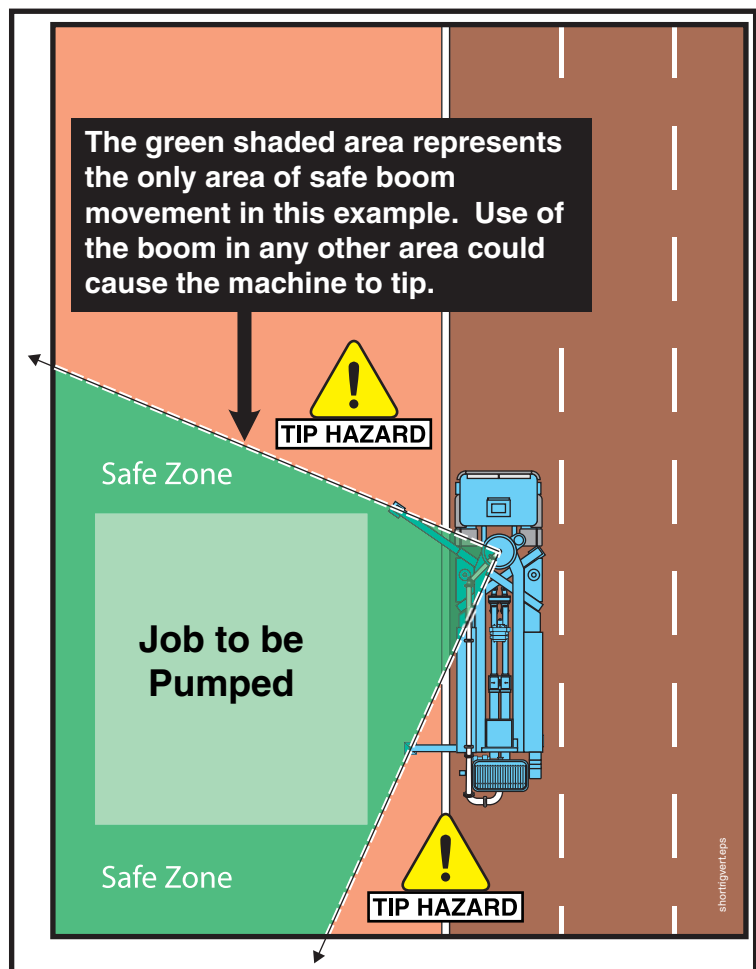

Figure 25
Shortrigging

- Unless otherwise specified by the manufacturer, you may only operate the boom when it is placed between outriggers that are completely extended; you may tip if the boom is placed anywhere else.
- You should still jack the outriggers that are not fully extended. This will assist in stabilizing and preventing the unit from rocking. The margin of safety this gives you is very small; and won't prevent you from tipping.

SAFETY MANUAL

- Don't get lazy! If it is possible to extend all of the outriggers, do it!
- Don't forget that you didn't fully extend all the outriggers. Explain to other workers on the job what will happen if you forget and slew the boom over unextended outriggers. That way, if they see you are moving the boom into a tipping area, they may be able to warn you.
- Outriggers that cannot be fully extended should NOT be partially extended unless specifically allowed by the manufacturer. The inner and outer outrigger box reinforcements will not align in intermediate positions. (Figure 26.)

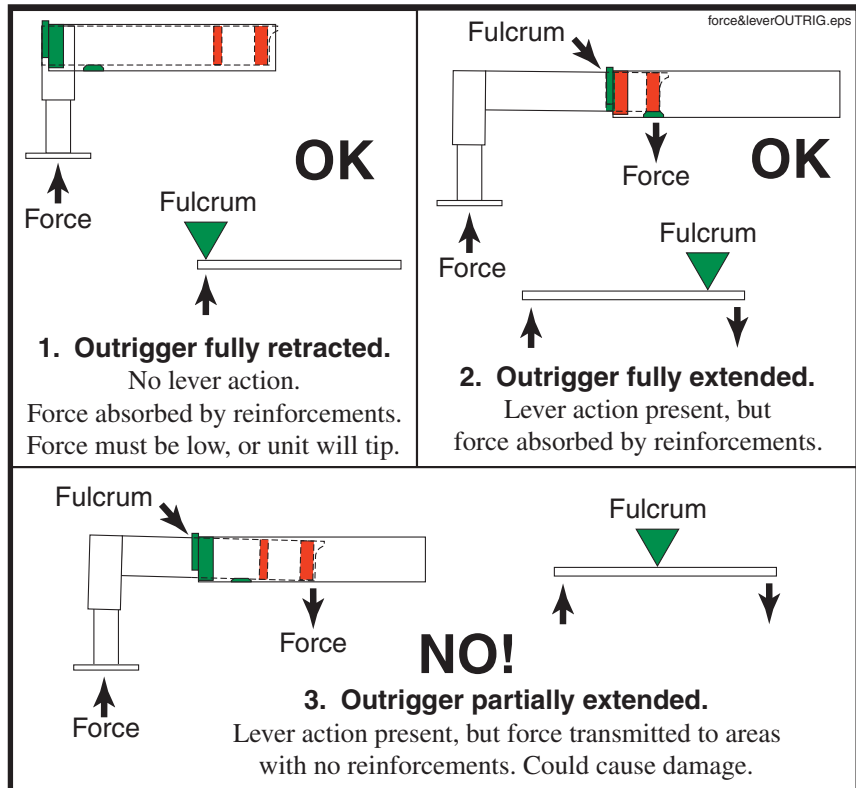
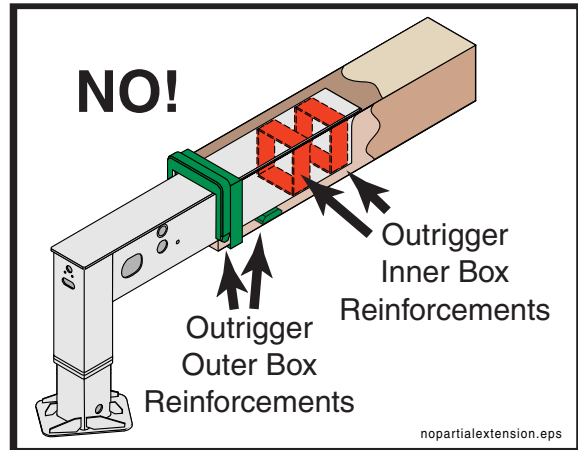



Figure 26
Partial extension

6.23  **WARNING** Tipping hazard! Do not unfold the boom until the outriggers have been correctly positioned and secured! The outriggers must be completely extended and opened as described in the operation manual. Do not partially extend the outriggers because intermediate positions are **not safe!** See the information regarding shorttrigging (paragraph 6.22).

6.24  **WARNING** Tipping hazard! Check soil conditions before jacking the outriggers. If necessary, use cribbing or suitable pads under the outrigger legs to increase the area of soil contact. See the chart in Figure 27 for examples of load bearing capacities of various soil types and for an example of how to calculate how much cribbing is needed. If in doubt, the site management may be able to supply the load bearing capacity of the soil.

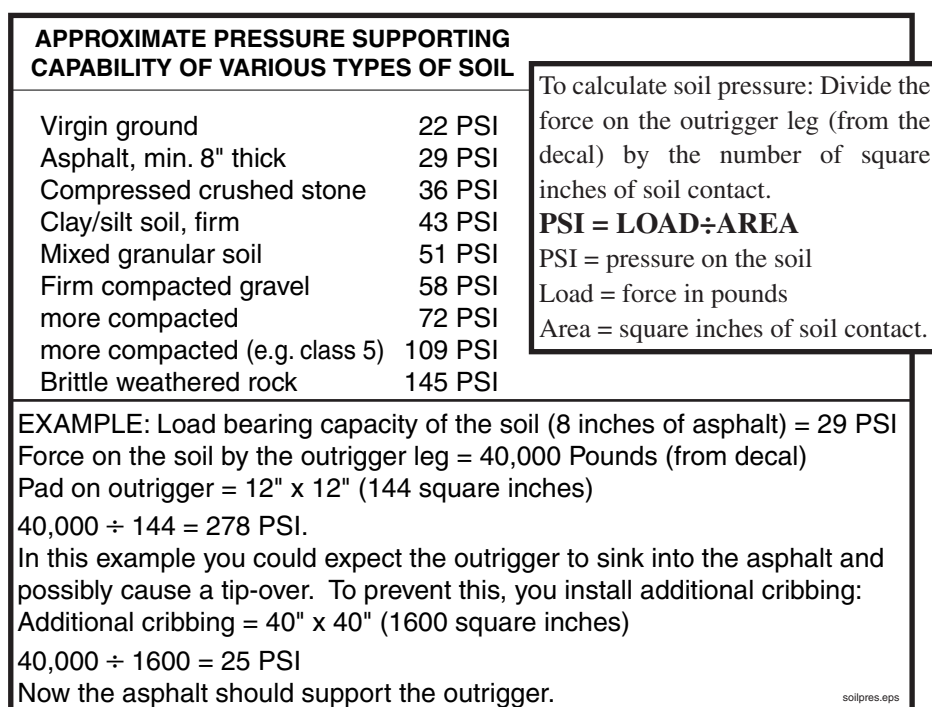





Figure 27
Calculating load bearing capacity

6.25  **WARNING** Always use at least the outrigger pads supplied by the manufacturer, even if setting up on concrete.

6.26  **WARNING** When setting the outriggers, jack the unit to within 3° of level, or according to the operation manual of your unit. If the unit is not set up within the specification for level, the boom brakes could fail, causing the boom to rotate downhill by the force of gravity.

6.27  **WARNING** **TIPPING HAZARD!** Maintain a safe distance between the unit and the edge of a cliff or any excavation. The rule of thumb is: for every foot of drop, stay back from the base edge at least 1 foot (the one to one rule). (See Figure

SAFETY MANUAL

28.) Note that the forces on the outriggers are transferred to the soil at a 45° angle. Watch out for the condition shown in Figure 29.

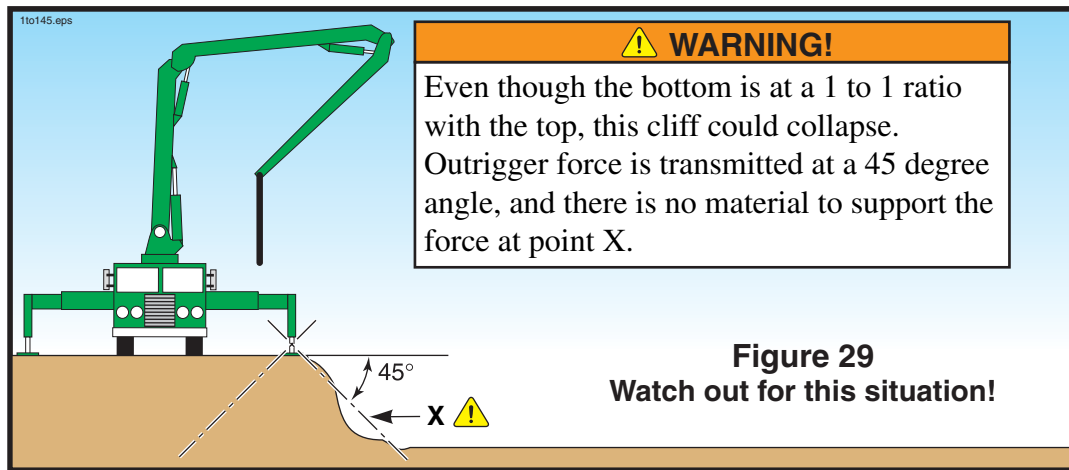
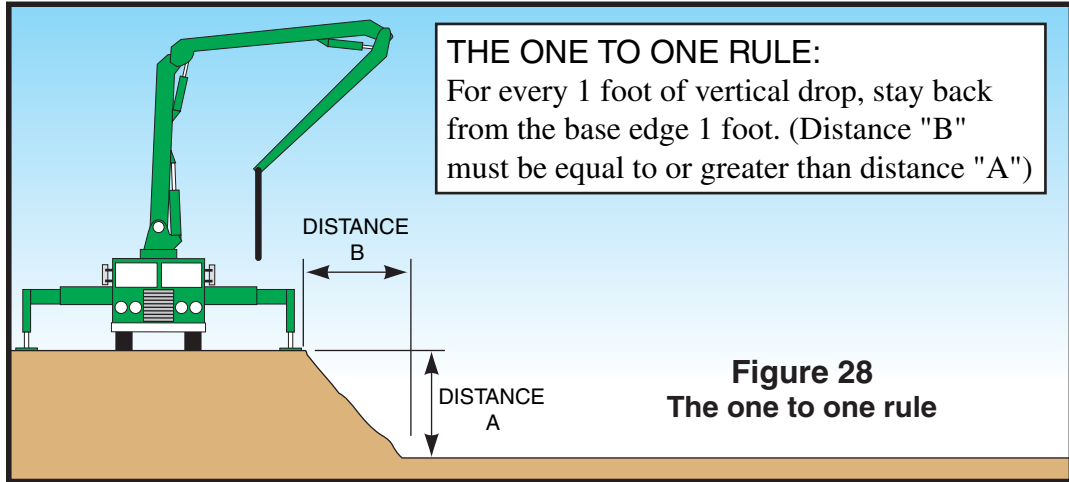

6.28

WARNING Look for recently backfilled areas, septic tanks and other indications of soft soil or underground voids (see Figure 30).

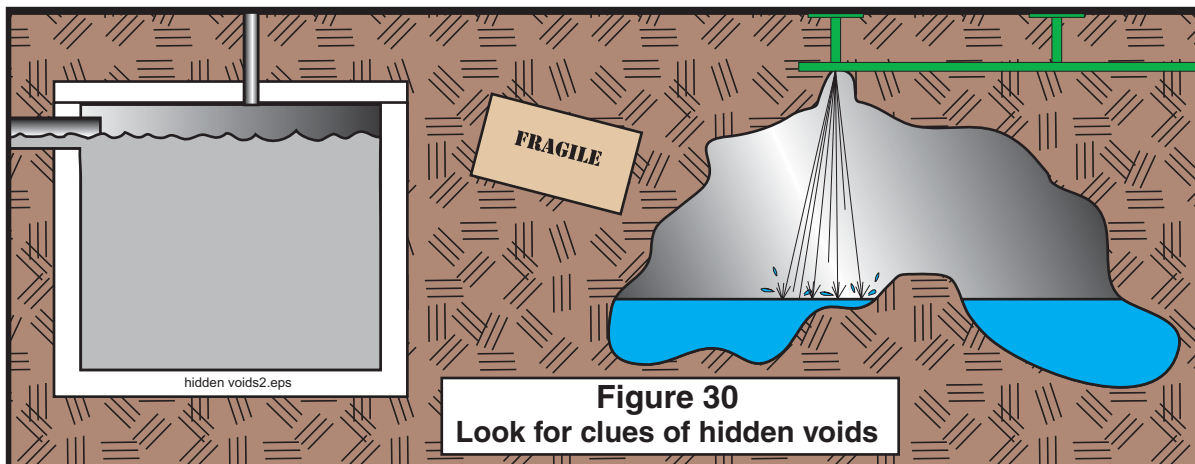

6.29

⚠ WARNING Tipping hazard! Take care when setting the outriggers (Figure 31). Never set up on uneven or hilly soil or try to bridge a hole with cribbing. In these cases, you could dig a flat spot in the soil (A, B, & C). Be sure that the outrigger pad contacts all pieces of cribbing. Run cribbing in the opposite direction, if needed (D).

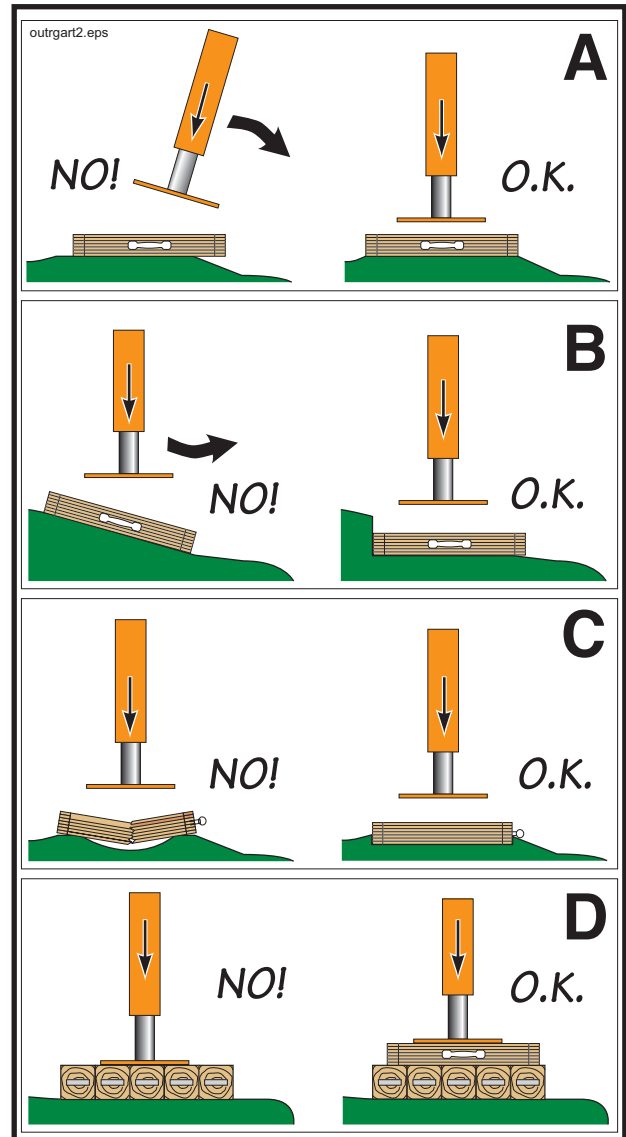

Figure 31
Beware of these
outrigger hazards

6.30

⚠ WARNING Tipping hazard! See Figure 32. Regardless of whether you know the load bearing capacity of the soil or not, you must test your setup:

- Fully extend all outriggers unless following shortrigging procedures;
- Use the pads supplied by the manufacturer and the dunnage indicated by the soil conditions;
- Jack each outrigger putting the full weight of the unit on the outrigger;

SAFETY MANUAL

- If the outrigger sinks make the dunnage base larger until the outrigger is stable using two layers of dunnage perpendicular to each other;
- After all outriggers are stable and the pump is within 3° of level, unfold the boom and slowly extend it over each fully extended outrigger. If the outrigger begins to sink, refold the boom and make the dunnage base larger. Repeat until all outriggers are stable;
- If you cannot stabilize the outriggers, you will need to relocate the pump. Do not proceed until all outriggers are stable;
- When you put concrete in the boom, again check the outriggers for sinking;
- After the pour begins, continue to check the outriggers for sinking throughout the course of the day.

The stability of the unit must be ensured!

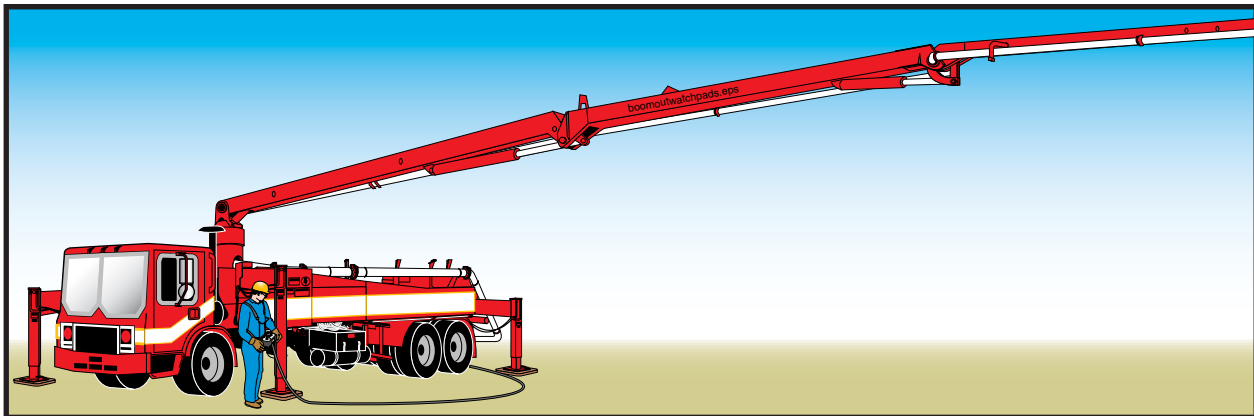

Figure 32

Verify that the outrigger pads are not sinking before and after concrete is in the boom

- 6.31** **⚠ WARNING** When you have the outriggers positioned correctly, close all outrigger hydraulic shutoff valves (if your machine is so equipped).
- 6.32** **⚠ WARNING** Do not unfold or operate the placing boom when lightning is present in the immediate area. If you are operating and lightning moves into the area, put the boom into the transport position, or another low position, and seek shelter until the lightning is gone.
- 6.33** **⚠ WARNING** Tipping hazard! Do not operate the placing boom when wind velocity exceeds 48 m.p.h. (77 k.p.h.) or per the manufacturer's instructions! When wind velocity exceeds the maximum allowed, the machine could tip and the boom may not be able to slew into or resist slewing away from the wind.
- 6.34** **⚠ WARNING** If you will be unable to see the point of placement, establish a system of communications with the workmen who will be there. Arrange for radio communications, a system of visual or auditory signals (lights or bells), or a spot-

ter. If a spotter is used, **agree on hand signals before beginning the pour!** (ACPA recommended hand signals are shown on page 82 of this manual.) If the boom will be moved extensively, arrange for a workman to stay with the pump and to put yourself in a position to see the end of the boom (Figure 33).

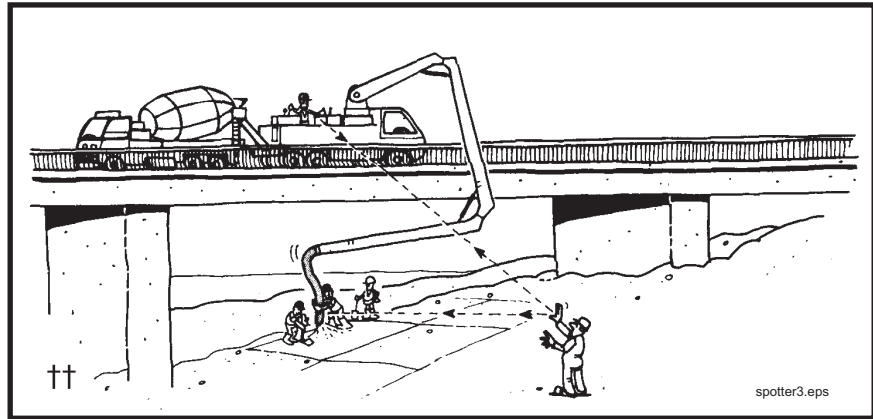

Figure 33
Arrange communications before starting

6.35

⚠ WARNING Use only material delivery system components in good condition. The useful life of delivery system components is affected by pumping pressure, concrete composition, pipeline material, velocity of moving concrete, and other factors. The use of ultrasonic equipment for determining pipe wall thickness of single wall pipe is highly recommended (Figure 34). For double walled pipe follow the manufacturer's recommendations. Read and understand the minimum wall thickness chart in the Appendix section of this manual. If you don't understand the chart, contact the service department of the manufacturer of your machine for assistance.

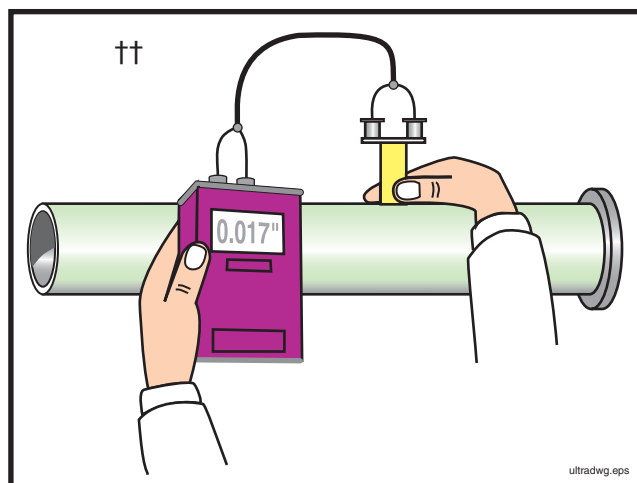

Figure 34
Check for wear on the delivery system components

SAFETY MANUAL

6.36

⚠ WARNING It is extremely important to verify that the material delivery system of the boom is capable of handling the pressure of the concrete pump. In some cases, you may not be able to use the boom if you are pumping on piston side. It is up to the machine owner and operator to determine if the boom can be used when pumping on piston side. Keep in mind that pipeline wears out with each stroke of the pump. Verify pipe wall thickness and compare it to pressure handling capabilities of that pipe style. The chart for this comparison is found in the Appendix of this manual.

6.37

⚠ WARNING Possible boom damage! If you will be pumping out of the boom into a separately laid pipeline, you must use a flexible hose to connect them. Do not connect steel pipe directly to the boom. **Be sure that the hose is capable of handling the maximum concrete pressure of the pump.** Do not let the end of the boom rest on the ground when connected to a separately laid pipeline. See Figure 35.

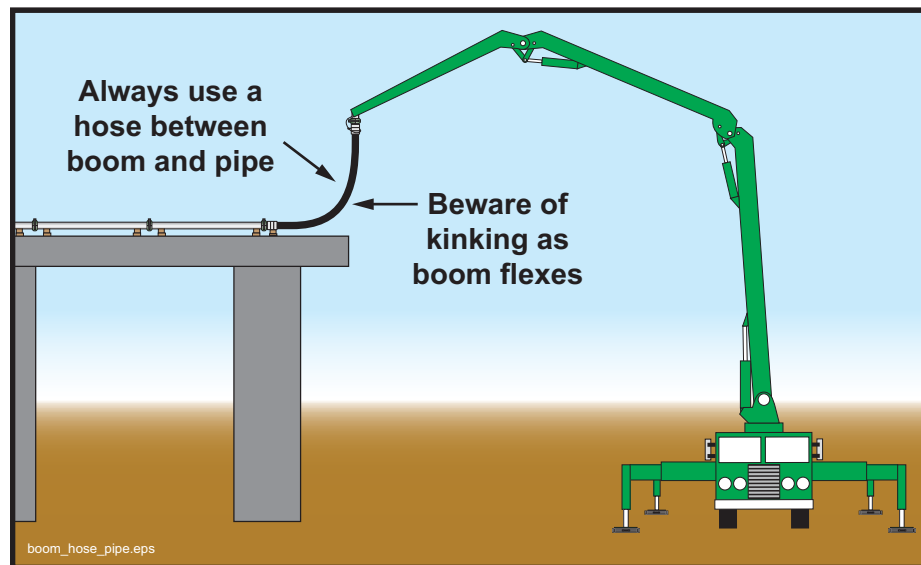

Figure 35

Use a hose between boom and pipeline

6.38

⚠ WARNING When the machine is ready to work, secure it against unauthorized use! Either stay with the unit or make sure no one can start it without you. This could be accomplished, for example, by activating the emergency stop switch of the remote control box (cable or radio, whichever is active), and take the transmission out of gear. Another way would be to have a spare key, take the transmission out of gear, lock the cab of the truck, and take the key with you.

6.39

⚠ WARNING Watch for children! When the machine outriggers are jacked up, it is possible for children to access the space underneath the machine. The rotating driveline(s) and hot components pose serious hazards. Keep children away from the machine.

6.40

⚠ WARNING If spectators will be near the pour, cordon off an area where they will be safe. Never operate the machine if it is not safe to do so, even if the spectators just want to see a certain operation or function.

7. Setting Up A Trailer Mounted Pump and/or A Separate Pipeline

- 7.1 **The job setup phase sets the stage for most accidents.** Taking a few extra moments to correctly set up the job will improve your chances of having a safe, trouble free day.
- 7.2 **The operator is responsible for the safe operation of the machine.** Notify your employer, the job superintendent, and/or O.S.H.A. if you are being asked to set up in an unsafe manner. **You are never required to take a chance with safety.** You are the **only** person who can determine that the job circumstances under your control are safe.
- 7.3 **⚠ WARNING** Any power connections above 24 volts must be made by a licensed electrician. The supply power and appropriate disconnect boxes are the responsibility of the contractor.
- 7.4 **⚠ WARNING** Electrical power on the job site may be taken only from a fused, grounded disconnect box with a disconnect switch that can be locked against activation. If you will be making repairs to the concrete pump or separate placing boom, first lock out the power at the disconnect box.
- 7.5 **⚠ WARNING** On units equipped with electric motors, check the power cables every day. If they are frayed or have open spots in the insulation, or if the connectors are worn or loose, have repairs made by a licensed electrician.
- 7.6 **⚠ WARNING** Consider the safe approach and departure of the ready-mix trucks and adjust your setup accordingly. Adjusting your setup position by a few degrees one way or another could mean the difference between a safe approach and an unsafe approach. Some examples of unsafe approaches are: too near an excavation or sticking out into traffic.
- 7.7 **⚠ WARNING** Avoid collisions! Secure the immediate area of the machine from public traffic in accordance with all applicable regulations (warning lights, safety cones, barricades with flashers, etc.).
- 7.8 **⚠ WARNING** Pipelines, end hoses, couplings, and all other material delivery components must be able to withstand the maximum concrete pressure of the pump. Be sure of it! Read and understand the minimum wall thickness chart found in the Appendix of this manual. If you don't understand the chart, contact the pipe manufacturer for assistance.
- 7.9 **⚠ WARNING** Do not use a piece of pipeline, end hose, coupling, or any other material delivery component that is not in good condition. **Replace, do not repair damaged pipes and hoses.** Concrete pipeline system is subject to wear, and the rate of wear is affected by pumping pressure, concrete composition, pipeline

SAFETY MANUAL

material, and other factors. Read and understand the minimum wall thickness chart in the Appendix of this manual. **Bursting pipes and concrete escaping under pressure is a serious safety hazard!** (See Figure 36.)



Figure 36
Delivery system components must be able to withstand maximum pump pressure

- 7.10** When laying out a pipeline, it is preferable to use an elbow instead of a hose to make direction changes. Elbows have less resistance to flow than hoses, and will therefore reduce the overall pressure required to push the concrete.
- 7.11** Use the largest diameter pipeline that is practical. Use steel pipe instead of rubber hose when practical. This will keep the pressure required to push the concrete to a minimum.
- 7.12** Support the delivery pipeline. Either an “S” transition pipe should be used to bring the pipe to ground level, or **each** section of the pipeline should be supported at the pump outlet level.
- 7.13** **⚠ WARNING** The sections of pipe nearest the pump are subjected to the highest pressure and the greatest wear. Because of this increase of pressure near the pump, you should install only thick walled pipe, in “like new” condition there. Read and understand the minimum wall thickness chart in the Appendix of this manual.
- 7.14** **⚠ WARNING** **The maximum material pressure of the pump must be the only factor used to determine what thickness of pipe and what type of ends are needed.** In the case of a rock jam or any other type of blockage, **the maximum pressure of the pump will be exerted.**
- 7.15** Grooved (Victaulic) ends are **not recommended** for concrete pumping. Read and understand the comparison between heavy duty raised, metric, and grooved ends in the Appendix of this manual.
- 7.16** **⚠ WARNING** If the pipeline remains on the job (as is the case when pumping a high rise building), **the operator is responsible for checking the pipeline for dents, cracks, wear, and continuity each day before the pour begins.**

7.17

⚠ WARNING In vertical runs, the weight of the vertical sections of pipe must be supported by a thrust block (often called a *deadman*, Figure 37) or other load-bearing device. **Each section of pipeline in a vertical run must be secured from lateral and horizontal movement.**

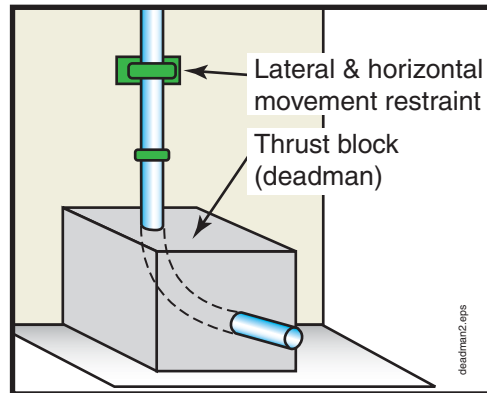

Figure 37
A thrust block (deadman)

7.18

⚠ WARNING If you will be unable to see the point of placement, establish a system of communications with the workmen who will be there. Arrange for radio communications, a system of visual or auditory signals (lights or bells), or a spotter (Figure 38). If a spotter is used, **agree on hand signals before beginning the pour!** (ACPA recommended hand signals are shown on page 82 of this book.)

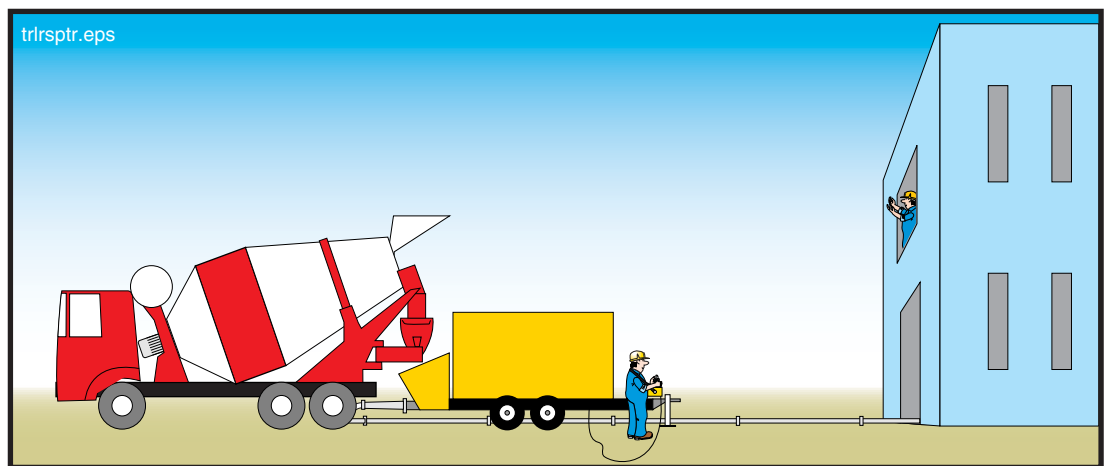

Figure 38
Arrange communications before starting

7.19

⚠ WARNING Never leave the machine unattended when it is running or ready to run. If you must leave the area, you must leave someone to monitor the unit. This is especially critical if there are children in the vicinity.

SAFETY MANUAL

- 7.20 **WARNING** Watch for children! It is possible for children to access the machine, but it is not safe for them to do so.
- 7.21 **WARNING** If spectators will be near the job, cordon off an area where they will be safe.
- 7.22 **WARNING** If you will be cleaning the pipeline with compressed air at the completion of the job, **be sure that you have all the necessary accessories to do the job safely.** If you don't have all of them, make arrangements to get them before you begin to pump. **Do not improvise on this. Make sure** that you have the right parts. The minimum accessories include:
- A blow out head with properly sized air discharge regulator valve, and separate water/air inlet. The two openings must be spaced apart far enough that a blowout ball could not cover both openings at once.
 - A *go devil*, or a hard sponge ball. Regardless of which is used, it **must** fit into the pipeline tight enough that air cannot escape ahead of it.
 - A ball or “go devil” catcher that will catch the go devil or ball, or some other method of controlling the discharge while the line is being purged of material. There are two types of catchers (see paragraph 7.23).
 - A hose that is rated for the pressure of the air compressor you will use and that is able to connect with both the air compressor and the blow out head. The hose must be in good working condition and must be free of cracks, frays, tears or other damage.
 - If you will be cleaning the pipeline with compressed air at the completion of the job, be sure an adequate air compressor is available before starting the job.
 - If you will be cleaning a vertical pipeline with compressed air at the completion of the job, you **must have a shutoff valve or switching valve installed at the bottom of the vertical run!**

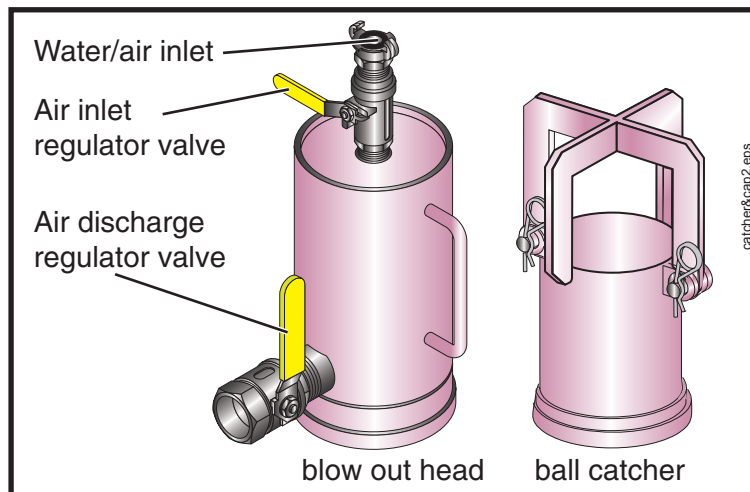

Figure 39
Ball catcher and blow out head

7.23

⚠ WARNING There are two types of ball catchers. Know which type of catcher you are using. You may need to adjust your clean out procedure according to which type you have. The two types are as follows.

1. Catchers that stop the ball or go devil before air can escape, and
2. Catchers that allow the air out of the pipeline after the ball or go devil has reached the end.

Each type has advantages and disadvantages (Figure 40).

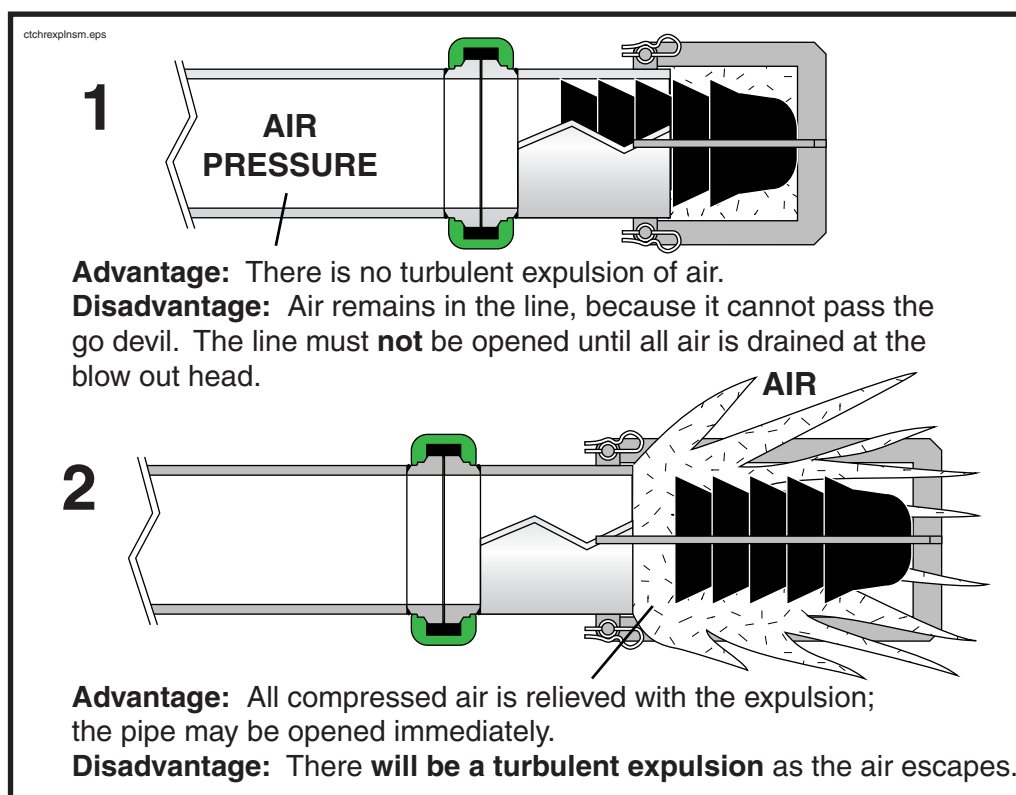

Figure 40
Types of catchers

With catcher type 1, the go devil stops, but air is still trapped behind it. The advantage is prevention of the sometimes violent expulsion of air at the end of the pipe. The disadvantage is that the air must be drained from the blow out head before the pipe line is safe to open. The pipeline must be controlled; allow no one to open it until all compressed air is relieved.

Catcher type 2 is long enough that the compressed air escapes behind the go devil. **Note!** This would happen with either catcher when used with a ball instead of a go devil. The advantage of this is that once you hear the turbulent expulsion, there is no pressurized air remaining in the line, and the line may be opened immediately. The disadvantage is the expulsion itself. In this case, the end of the line must be controlled because flying concrete and aggregate pose a hazard.

Both catchers can be safely used if care is given to the hazards involved.

III. Concrete Pump Operation

8. Safety Rules For Pump Operators

8.1 **⚠️ WARNING** Only qualified operators are allowed to operate the pump. A “Qualified Operator” is defined as someone who:

- has reached the age of 18 years (21 for interstate travel),
- is physically and mentally capable,
- has been trained in the operation and maintenance of the pump and the placing boom (if applicable),
- has demonstrated his/her capabilities to the employer in respect to the operation and maintenance of the pump and placing boom, and
- can be expected to perform these duties, as assigned, in a reliable manner.

8.2 **⚠️ WARNING** Because the operator is responsible for the safe operation of the machine, it is crucial that he/she understands the proper operation of the machine and the safety rules that apply to the job at hand, so the course of action taken in unforeseen circumstances will be a safe one. Only thorough training and supervised job experience can supply the necessary understanding.

8.3 **⚠️ WARNING** When operating the machine, wear **Personal Protective Equipment**. (See Figure 41.)

* Needed when exposed to airborne cement particles (or any other toxic dust).



Figure 41
Wear Personal Protective Equipment (P.P.E.)

8.4 **⚠️ WARNING** All guards, covers, and service flaps must be secured in place during operation.

8.5 **⚠ WARNING** **Electrocution hazard!** If you are operating and lightning moves into the area, put the boom into the transport position, or another low position, and seek shelter until the lightning is gone.

8.6 **⚠ WARNING** **Crushing hazard!** Never, ever position yourself between a ready mix truck and the pump! Stand off to the side, so the ready mix driver can see you at all times (Figure 42).

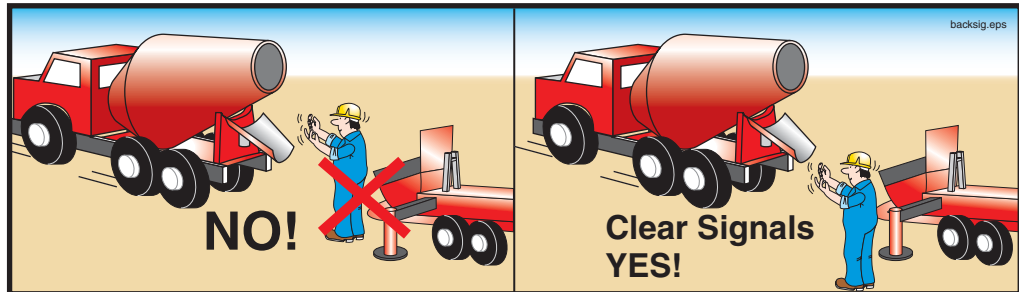

Figure 42
Never stand between the ready mix truck and the pump
Use clear and concise hand signals

8.7 **⚠ WARNING** When backing in ready mix trucks, use clear and concise hand signals (Figure 42).

8.8 **⚠ DANGER** You must avoid hazardous proximity or contact with power lines under all circumstances. **Be sure** that you maintain 17 ft. (5 meter) clearance! The 17 foot clearance allows room for the movement of the wires and the boom by wind force, electrical arcing, and human error (Figure 43). **Do not take chances with high voltage; it is the number one killer of concrete pump operators!**

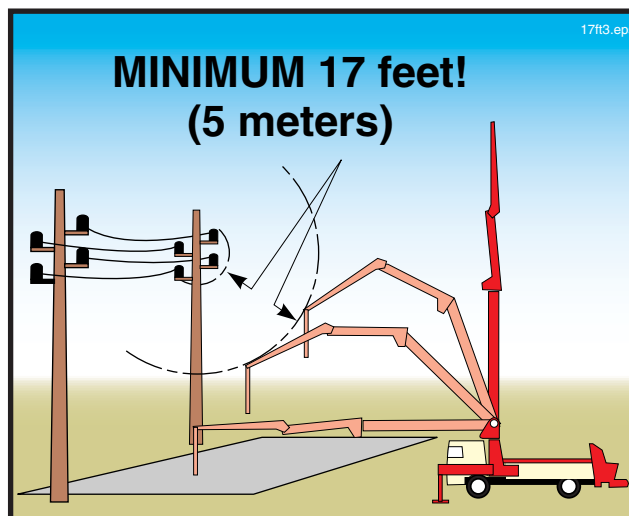

Figure 43
Maintain a clearance of at least 17 feet from wires

SAFETY MANUAL

8.9 **⚠ DANGER** When overhead wires are in the area that the boom will be moving to complete a pour, a spotter must be employed whose only job is to warn the operator if the boom comes within 17 feet of the wires. The spotter must understand the responsibilities assigned, and must be able to judge a 17 foot distance.

8.10 **⚠ DANGER** Direct contact with a live power line is always dangerous to everyone and anyone electrically connected to the machine (Figure 44). Use **extreme caution** near high voltage wires.

Figure 44
If the pump is energized, everything that touches the pump is also energized

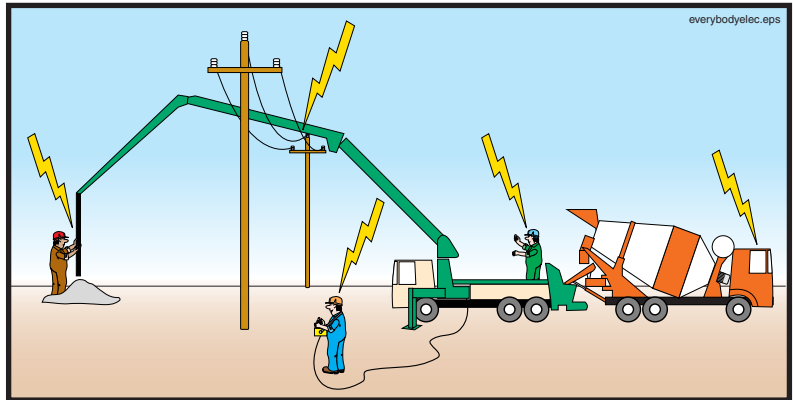

8.11 **⚠ DANGER** Do not rely on depth perception when working near high voltage lines. **You must use a spotter!** (See Figure 45.) See the definition of “spotter” in the glossary found in the Appendix of this manual.

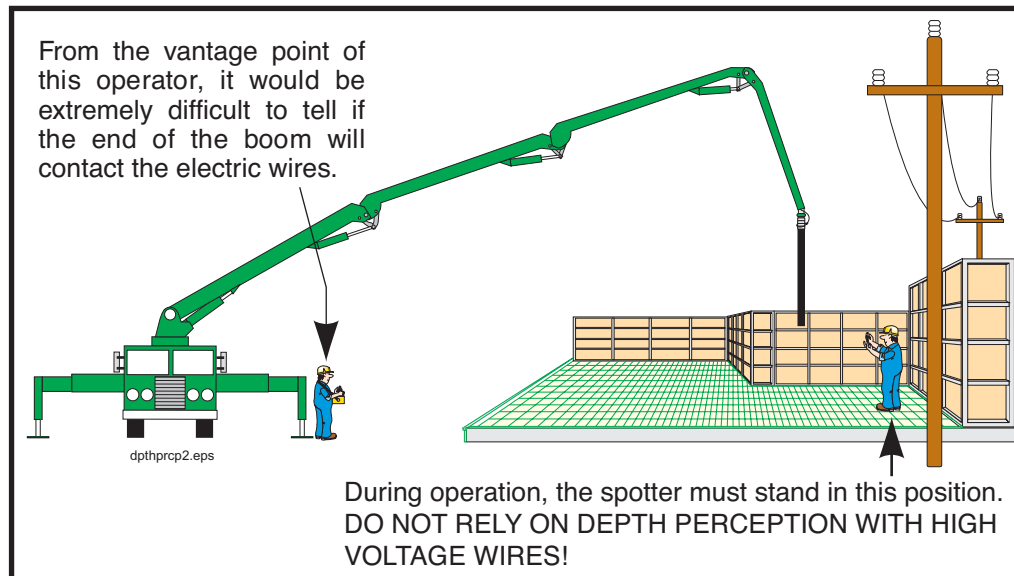

Figure 45
Never rely on depth perception with high voltage wires

8.12

⚠ DANGER Watch for wires that are not directly in the area of the pour. Accidents can happen when moving between points of placement, or when moving the boom after the pour is completed (Figure 46). **Never let down your guard when the boom is in the air!**

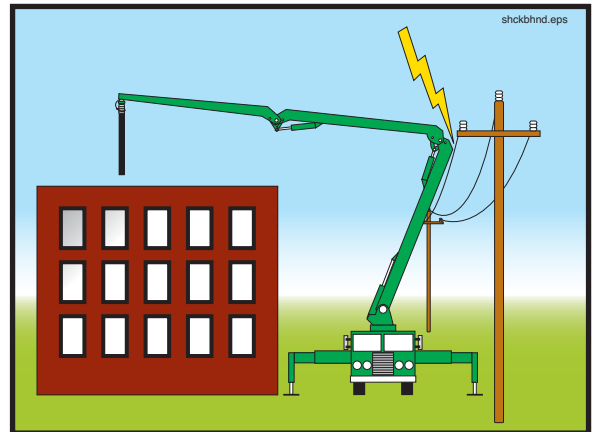
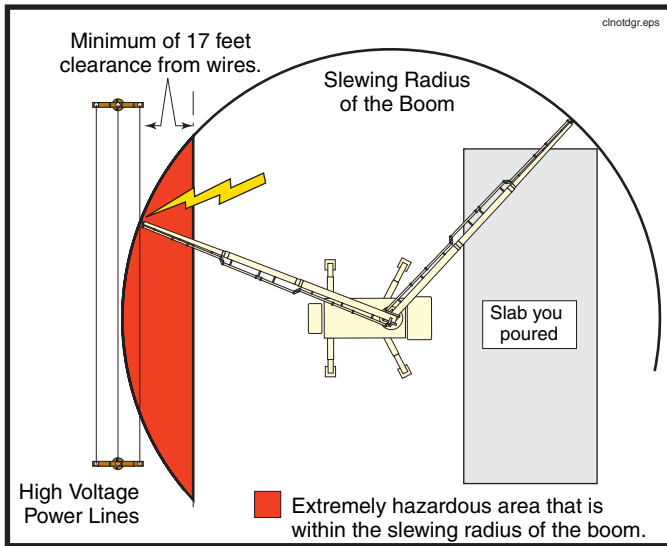

Figure 46
Never let down your guard when moving the boom

8.13

⚠ DANGER High voltage makes conductors out of materials that would normally not conduct! Many nonconductors will conduct enough current to kill you if you contact the 8000 volts to ground that is normally found on power poles in the United States (Figure 47). Voltage in the wires may be higher than 8000, especially in industrial areas.

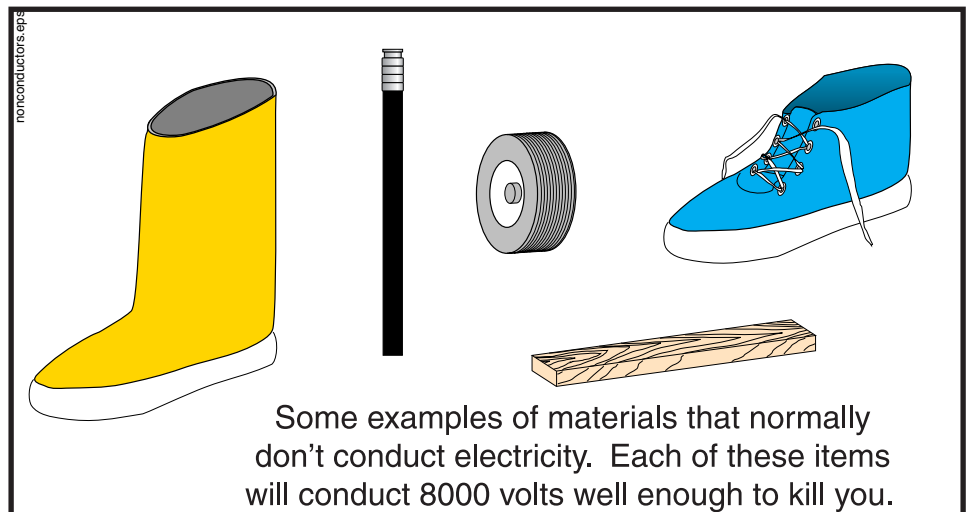

Figure 47
Even poor conductors will conduct high voltage

SAFETY MANUAL

8.14

⚠ CAUTION **Loss of hearing!** While standing near a working concrete pump, sound pressure levels may exceed O.S.H.A. standards for constant exposure (Figure 48).

PERMISSIBLE NOISE EXPOSURES*
 *Under part 1910.95 “Occupational Noise Exposure,” (Dept. of Labor) of the Code of Federal Regulations, Chap. XVII of Title 29 (39 F.R. 7006).

DURATION per DAY in HOURS	Sound level in dB (A) Slow response
8	90
6	92
4	95
3	97
2	100
1 1/2	102
1	105
1/2	110
1/4 or LESS	115



††

WEAR HEARING PROTECTION!

Figure 48
Noise level and exposure time limits

8.15

⚠ WARNING Do not allow unauthorized persons in the operational area of the pump and boom. Warn unauthorized persons present in the area to leave and stop work if they do not comply.

8.16

⚠ WARNING Do not use the boom as a hoist or crane! (Figure 49.)

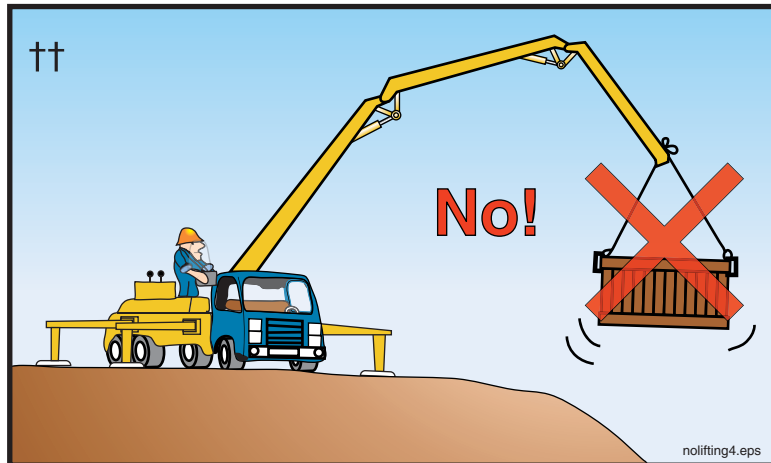

Figure 49
No lifting with the boom

8.17

⚠ WARNING **Explosion hazard.** Never remove the fuel cap or refuel the unit near hot surfaces, sparks, or open flames. Never smoke while refueling.

8.18

⚠ WARNING Do not let the concrete level in the hopper become low! If air is sucked into the material cylinders, the pump will compress the air. Compressed air always poses a hazard as it is expelled from the hopper or the delivery pipeline (Figure 50). If air is taken into the material cylinders, take the following steps to minimize the hazard:

1. Stop the pump immediately. Hit the emergency stop button if that is the quickest way to stop the pump. There will be an expulsion of compressed air the next time the concrete valve shifts, which can be safely absorbed by filling the hopper with concrete.
2. If possible, fill the hopper with concrete to just below the grate, then pump slowly in reverse for several strokes. This will not remove all the air, but it should minimize the amount left in the pipeline.
3. Persons standing at the discharge end or near the delivery line must be warned to move away until all of the air has been purged. Personnel should move a prudent and reasonable distance beyond the end-hose movement area or the point of discharge, and personal protective equipment (PPE) should be worn (Figure 50).
4. When the pump is restarted, pump forward slowly until **all** air is removed from the pipeline. Don't assume that the first little air bubble is the end of the compressed air.
5. Do not allow anyone near the discharge until concrete runs steadily from the end and there is no movement of the delivery system.

If workers are positioned in high or precarious places, warn them to expect a loud sound as the air escapes the pipeline. (Warn them even if they are well away from the discharge.) That way, we can prevent the worker from falling as a result of being startled by the noise.

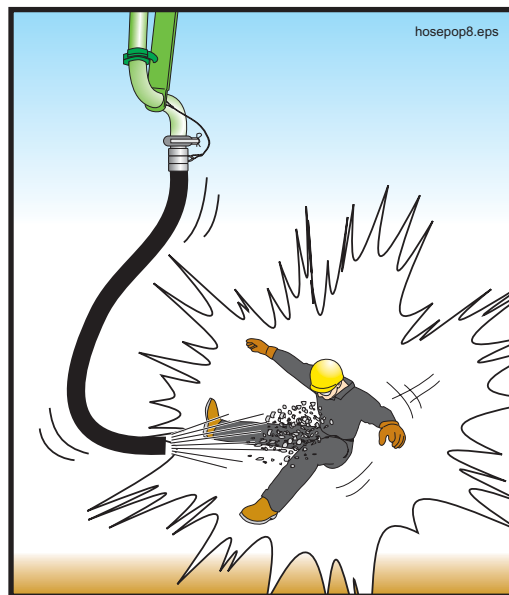



Figure 50
Remove everyone from the discharge area
whenever air is in the line

SAFETY MANUAL

8.19

 **WARNING** Air can be introduced into the delivery system in several ways. For example:

- when initially priming the delivery system,
- when restarting after moving,
- when restarting after adding or removing delivery system,
- when attempting to remove a blockage by “rocking” the concrete,
- when pumping is stopped and the boom is at a downward angle

Whenever air has been introduced into the line for any reason, warn everyone to stay away from the discharge until material runs steadily. Personnel should move a prudent and reasonable distance beyond the end-hose movement area or the point of discharge, and personal protective equipment (PPE) should be worn (Figure 50).

8.20

 **WARNING** A bulk density of approximately 150 pounds per cubic foot is assumed for the material to be pumped with a placing boom (normal concrete). If you intend to pump material with a higher bulk density (e.g., steel fiber entrained concrete), you must contact the manufacturer for advice. Failure to do so may result in damage to the boom and/or instability in certain operating positions.

8.21

 **WARNING** **Blockages in the pump or delivery pipeline can create an unsafe condition.** Blockages are caused by many different factors, as outlined below.

CAUSES OF BLOCKAGES

- **Faulty concrete mix design.** The concrete that is being supplied may not be a pumpable mix, for example there may be too much sand or too little cement. There may be bleeding or segregation. Some admixtures adversely affect pumpability (e.g., too much air entrainment). If the mix is not pumpable, no amount of operator expertise will make it so.
- **The line size may be inadequate.** The line size should always be at least 3 times larger than the largest aggregate being pumped, or blockages could occur.
- **Worn concrete valve parts.** Worn parts allow the finest material and water to escape back into the hopper when pressure is applied.
- **Pipeline and joint deficiencies.** This would include dirty pipes (pipes that have not been cleaned properly), worn and leaking pipe joints that allow loss of concrete fines and water, pipes that haven’t been properly primed before starting, and too many sections of rubber hose, which increases friction. These are all causes of blockages that can be controlled by the operator.
- **Pump inadequate for the application.** The pump selected for the job may not have enough pressure or horsepower available for the required duty.
- **Concrete setting up in the pipeline.** This may be caused by delays on site (e.g., repairing a broken form), or by attempting to pump “old” concrete (concrete that was batched hours before pumping and is being kept alive only by adding water and constant agitation). Weather conditions can also affect how quickly the concrete becomes hard. Companies should establish procedures for these situations. A good rule of thumb is: **If in doubt...wash out.**

- **Foreign matter in the concrete.** Pieces of old concrete that break away from mixer fins, unmixed clumps of cement, mixer fins, hammers, and furry mammals are examples of foreign matter that have caused blockages.
- **An inexperienced operator can cause blockages by setting up the job improperly.** For example, if the placing crew is forced to add hose or pipe to reach a far point after the pour is already in progress, there is a great chance of creating a blockage due to the dry conditions inside the pipe or hose. It is for this reason that the job should be set up so pipe or hose need only be removed (never added) as the day progresses. If dry pipe or hose must be added, it must be lubricated just like the rest of the pipe was lubricated when you first started.
- **An inexperienced or improperly trained placing crew can cause blockages by kinking the end hose.** This type of blockage can lead to serious accidents because the hose may un-kink by the force of the pump.
- **The concrete becomes segregated in the hopper.**
 - a. If the concrete is too wet, the cement and fine material get washed from the stone and coarse sand. This mix will not pump. It is for this reason that you should cover the hopper as you wait out a passing storm, never allow a truck mixer to wash out in your hopper, and never add water to the mix. (Figure 51.)
 - b. If concrete is over vibrated, it will separate. Turn off the hopper vibrator when not actively pumping.

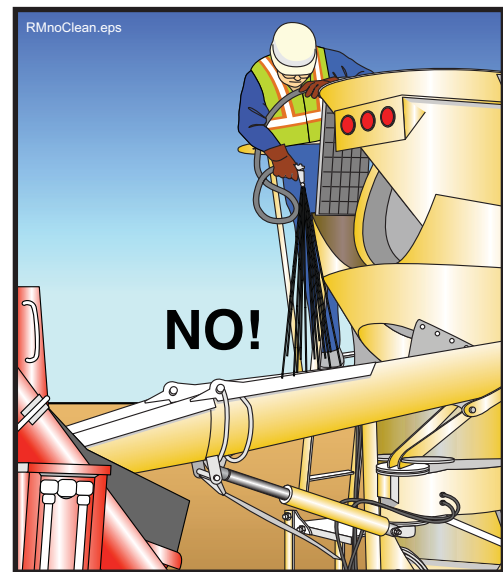

Figure 51
No water in the hopper

8.22

⚠ WARNING Never try to remove a pipeline blockage by applying high pressure to it, because that will cause the blockage to become a plug. If you have a blockage, immediately stop the pump. Stroke the pump several times in reverse. Slowly stroke the pump in forward, and try to dislodge the blockage. If you are moving the blockage, continue to do so slowly and gently. While attempting to clear the blockage, remove all personnel from the discharge area, as air may be introduced into the placing line during this process. If you are unable to move the blockage after a couple of attempts, stop the pump. Continuing to apply high pressure could create a hazardous condition.

SAFETY MANUAL

8.23 **⚠ WARNING** If the pump or associated equipment develops a problem that creates an unsafe condition, you must stop pumping immediately! Do not restart until the unsafe condition has been remedied.

8.24 **⚠ WARNING** The following points must be observed when locating a blockage.

- Pump in **reverse** for **at least two strokes**, then stop the pump. **Do not allow anyone to open the pipeline** until this is done (Figure 52).
- Wear personal protective equipment when opening a blocked pipeline.
- Clear the area of nonessential personnel before opening the line.
- Plugs will be found in (in the order of likelihood) reducers, hoses, elbows, and pipe.
- If you are tapping the pipe to find the plug, the sound will be a dull thud (tik-tik) rather than a ringing sound (tong-tong) at the spot of the plug, because the jammed material will keep the pipeline from vibrating. (This method won't find a plug in a hose.)

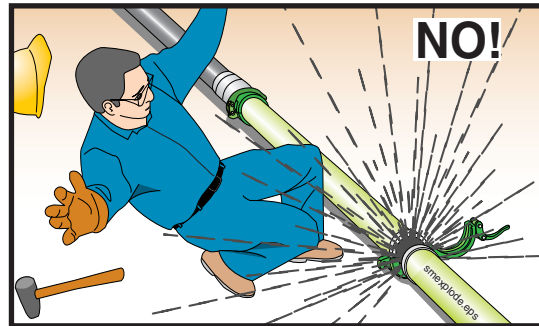

Figure 52
Never open a
pressurized pipeline

8.25 **⚠ WARNING** It is possible that some pressure will remain in the pipeline after reversing the pump. Use a shovel or pry bar to open the clamps on a blocked pipeline. Wear face protection, and turn away from the pipeline when opening the clamp.

8.26 **⚠ WARNING** It would be better to let the pipe be ruined by setting concrete than to risk injury by ignoring safe procedures. Always use safe practices when cleaning pipe. Remember, pipeline is replaceable, you are not.

8.27 **⚠ WARNING** Never stand on, sit on, or straddle a pipeline while it's in use, or whenever it is pressurized. Pipeline wears out with each stroke of the pump. If the pipe bursts, you want to be to the side of it, not on top of it (Figure 53).

8.28 **⚠ WARNING** **Do not kink hoses.** Kinking will cause the pump to create maximum concrete pressure. **The pump may unkink the hose with force!** (See Figure 54.)

8.29 **⚠ WARNING** Never use compressed air to clear a blockage! It is unsafe and unnecessary. The pump can develop much more pressure than an air compressor. If the pump pressure can't move it, air pressure won't either.



Figure 53
Never straddle or sit on a
pressurized pipeline



Figure 54
Kinking the hose
creates a hazard

8.30

⚠ WARNING Crushing/amputation hazard. Do not remove the water box covers or grates when the machine is stroking (Figure 55). If you must remove the water box cover (to add water, for example), and there is not a bolt-down grate over the water box, stop the pump and take the transmission out of gear so the pump cannot be restarted until you are finished and the covers are back in place. If a bolt-down grate is installed, you may simply stop the pump from stroking before removing the water box covers. Replace the covers before restarting the pump.

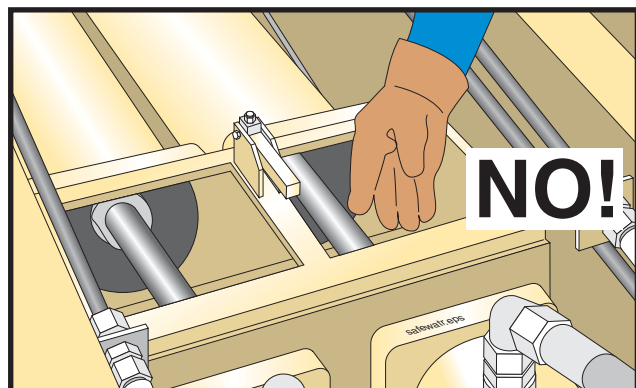

Figure 55
Keep your body out
of the waterbox

SAFETY MANUAL

8.31

⚠ WARNING Never leave the pump unattended! Before you leave a laborer, ready mix driver, or any other worker alone with the pump for any reason, make sure the worker who you leave with the pump knows:

- the safety rules for a person stationed at the pump (the rules are listed in this Safety Manual, beginning on page 59)
- how to stop the pump
- the location of the emergency stop switches
- how to signal you.

8.32

⚠ WARNING To prevent any unintentional movements of the machine, all control devices on the operator's panel and the remote control box must be switched off before changing from remote control to local control, or vice-versa. Whenever you are connecting or disconnecting the remote cable, push in the emergency stop button.

8.33

⚠ WARNING Crushing/amputation hazard. Never put your hands, feet, or any other body part into the water box, concrete valve, or hopper when the hydraulic system is operational or ready to operate! (See Figure 56.)



Figure 56
Don't put your body
in the machine

8.34

⚠ WARNING Do not work on the hopper, water box, concrete valve, or the hydraulic system unless the drive engine is turned off and the accumulator pressure (if so equipped) has been released! On units with internal combustion engines, the key must be removed. If there is more than one key, you should tag the ignition. On units driven by electric motors, the main disconnect must be locked out according to applicable standards.

8.35

⚠ WARNING Never operate the boom “blind.” If you can’t see the point of placement, you must establish a system of communications with the workmen who can see the point of placement. Arrange for radio communications, a system of visual or auditory signals (lights or bells), or a spotter. If a spotter is used, **agree on hand signals before beginning the pour!** (The ACPA recommended hand signals are shown on page 82 of this book.) If the boom will be moved extensively, arrange for a workman to stay with the pump and put yourself in a position to see the end of the boom (Figure 57).

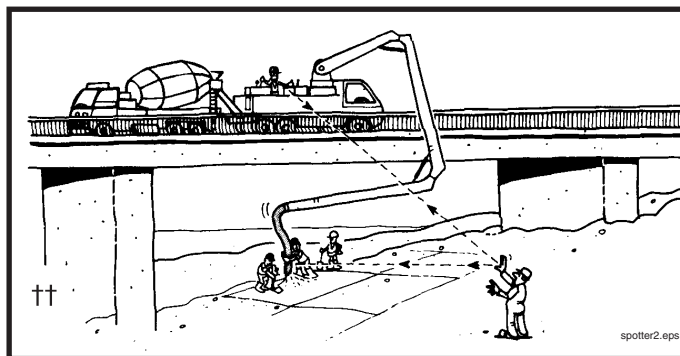

Figure 57
Never pump blind

8.36

⚠ WARNING Always block the discharge end when you must swing a full boom over workers or property (when you are not pumping). You must stop concrete from falling out of the boom. This can be done with a shut-off valve, or by removing the hose and putting a blanking plug on the last elbow (Figure 58), or by kinking the end hose and securing it in the kinked position. Please note— hoses that can be easily kinked may not be strong enough to withstand the pressure of the pump. Verify the working pressure of the hose against the maximum pressure of the pump before using this type of hose.

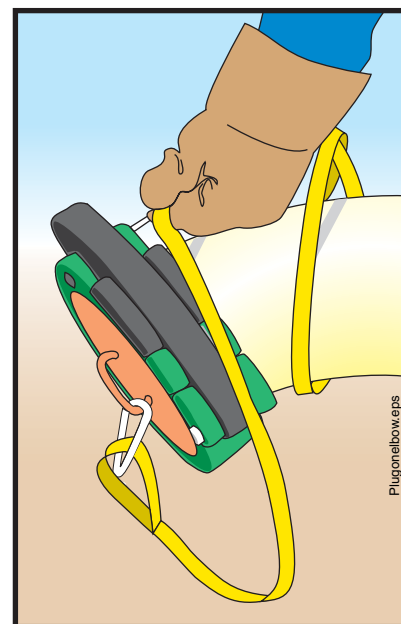











Figure 58
A blanking plug in place on a tip
elbow with safety sling

IV. Cleaning The Pump And System

9. Safety Rules For Cleaning The Boom

- 9.1  **WARNING** Do not let down your guard when the pour is completed. Accidents also happen during cleanout and the drive back to the yard. It is important not to become relaxed about job safety until you are no longer on the job.
- 9.2  **DANGER** Watch for electric wires when moving the boom for cleanout or folding the boom for transport!
- 9.3  **WARNING** Using compressed air to clean the boom delivery system should only be done when no other method is practical or as recommended by the manufacturer.
- 9.4  **WARNING** If you have to use compressed air for cleaning the boom you **must** have all of the necessary accessories. Read and understand the complete safety rules regarding cleaning out with compressed air (point 12.5 on page 49 of this Safety Manual). Cleaning with compressed air should only be done by a qualified person.
- 9.5  **WARNING** **Never** use compressed air to blow through rubber hoses or sections of pipe less than 40 feet (12 meters). In the case of rubber hoses, their flexibility will allow them to “whip” wildly with the force of the air and moving concrete. Short sections of pipe will not have sufficient mass to allow the concrete to move slowly, so there will be rapid expulsion of the material.
- 9.6  **WARNING** If the ball or go devil doesn't come out of the delivery system after applying compressed air, **you must relieve the pipe of air pressure before opening it.** If the bleed off valve plugs when you are draining the air, the only safe way to proceed is to drill small holes into the pipeline, which will then allow the air to escape. Wear a full face shield when drilling the holes. Pipe you have drilled into is ruined and must be replaced. Drill the holes to relieve the air pressure even if the concrete has set up in the pipe. The pipe is hazardous until the pressure is relieved.
- 9.7  **WARNING** Exercise care when “tapping” on the pipeline to find the location of the cleanout ball. Applying too much force will dent a single wall pipe (making it weak and unsafe) and could break the carbide insert of double wall pipe.
- 9.8  **WARNING** It is better to let the pipe be ruined by setting concrete than to risk injury by ignoring safe procedures. Remember, pipeline is replaceable, you are not.

10. Safety Rules For Cleaning The Concrete Valve & Hopper

- 10.1  **WARNING** Tipping hazard! Before moving the unit for cleaning, **secure the boom and outriggers into the travel position.**
- 10.2  **WARNING** Wear protective clothing and equipment when cleaning the concrete pump because the lime in concrete can burn your skin. Protect against concrete burns and concrete poisoning by wearing rubber boots and gloves during cleanout or any other time that you will be **in** contact with the concrete.

10.3 **⚠ WARNING** Crushing and amputation hazard! **Never put your hands or any other body part into the concrete valve.** Instead, use water jets and the supplied rake (Figure 59).

10.4 **⚠ WARNING** **Never put your hands or any other body part into the machine when the hydraulic system is operational.** If you must remove the grate to chip at hardened concrete, you must first disable the system by taking the transmission out of gear and locking the cab door, or stopping the engine, relieving pressure in the accumulator circuit (if so equipped) and securing the controls against unintended operation. Reinstall the grate before restarting the engine (Figure 59).

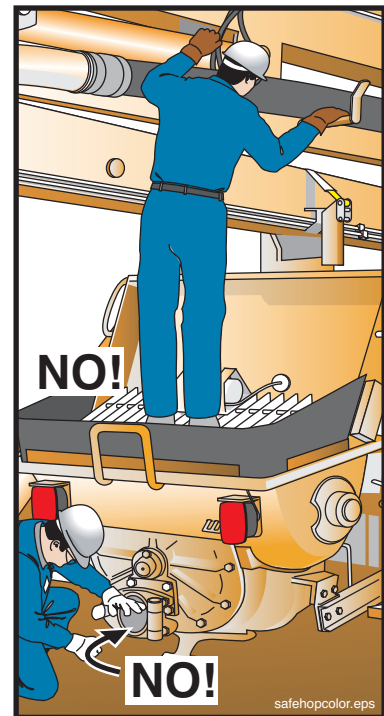



Figure 59
Keep your body parts
out of the machine

11. Safety Rules For Cleaning The Water Box

11.1 **⚠ WARNING** Crushing and amputation hazard! Stop the concrete pump before removing the water box covers. If your unit has bolt down guards, do not remove them for cleaning. If there is not a bolt-down guard over the water box, then stop the pump, take the transmission out of gear, and lock the cab so the pump cannot be restarted until you are finished cleaning and the covers are back in place. If a bolt-down grate is installed, you may simply stop the pump from stroking before removing the water box covers. Replace the covers before restarting the pump.

11.2 **⚠ WARNING** If possible, position the folded boom in a slightly raised position when cleaning the water box (watch for wires when raising the boom). The outriggers must be extended and jacked. If the boom is raised, it will be unnecessary to bend over the water box for cleaning. Be sure boom is stowed and outriggers are secured for travel before moving the unit.

SAFETY MANUAL

11.3  **WARNING** Falling hazard! Be sure of your footing when cleaning the water box.

11.4  **WARNING** Crushing and amputation hazard! Do not remove the water box guards for cleaning. Clean the water box with water jets only. **Do not put your hands or any other body part into the water box for cleaning, or at any other time when the hydraulic system is operational.**

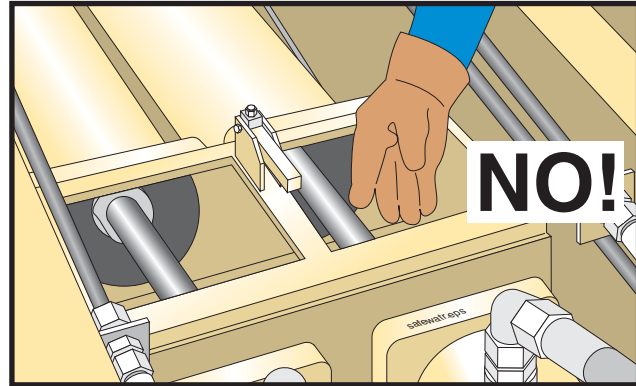





Figure 60
Keep your hands out of the waterbox

12. Safety Rules For Cleaning A Separately Laid Pipeline

12.1  **WARNING** Flying particle hazard! Clear the discharge area of personnel and equipment before forcing a ball or go devil through the pipeline, even if you are cleaning with water. Some air will be trapped in the pipeline, and the trapped air will become compressed before discharge.

12.2  **WARNING** Short pipelines and single pipe sections should be cleaned by removing the clamps and dumping the pipe sections. Remember to lift with your legs, not with your back.

12.3  **WARNING** The point of discharge must be controlled. Use a ball catcher or some other containment device at the point of discharge, even when cleaning with water.

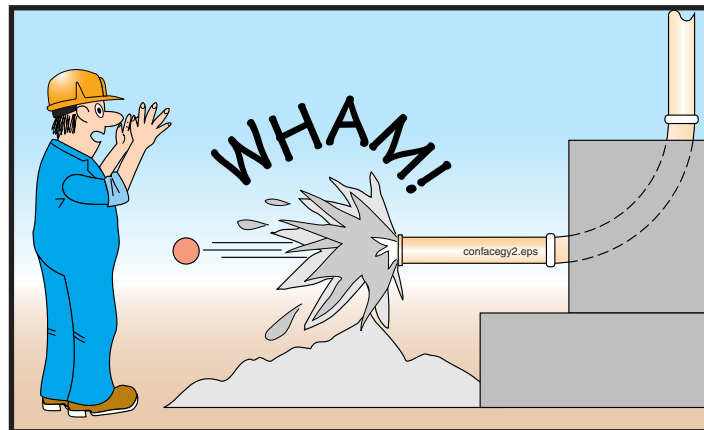

Figure 61
Cleaning with compressed air can be extremely hazardous if you don't follow the safety rules

12.4

⚠ WARNING Never use compressed air to attempt to clear a blockage! It is unsafe and unnecessary. If the pump pressure can't move it, air pressure won't either.

12.5

⚠ WARNING Blowing out with compressed air creates potential hazards! Serious injury or death could result if you do not adhere to these safety points.

- **Blowing out must be performed under the supervision of a qualified person.** (See the glossary for the definition of *qualified person*.)
- **Blowing out requires two people!** One trained person must be at the inlet end to operate the air insertion, and the other trained person must be near (but safely back from) the discharge point to monitor the discharge and to make sure that no one enters the hazard area.
- **No pipe bends or flexible delivery hoses may be connected to the end of the pipeline during the blowing out process,** unless there is a pre-planned cleanout station erected to route the discharge into the ready mix truck.
- **The point of discharge must be controlled. Clear the discharge area of personnel and equipment** before beginning the blowing out process. Do not allow anyone to enter the area during the blow out process. If a ball catcher is used, be aware of which type you have, and adjust your procedure accordingly. Ball catcher types are described in paragraph 7.23 on page 33.
- **The concrete outlet must be positioned high enough to permit easy discharge of the material.**
- If you are going to divert the discharge into a discharge pipe system, **you must lubricate the discharge line with slurry, or a plug could occur.**
- **The pipe cleaning blow out head must be equipped with a properly sized air discharge regulator valve and a separate water/air inlet.** The two openings should be spaced apart far enough that a blowout ball could not cover both openings at once (Figure 62).

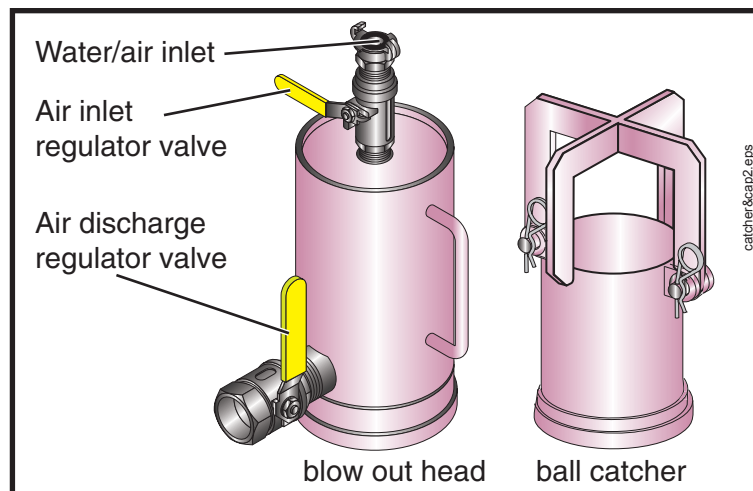

Figure 62
Ball catcher and blow out head

SAFETY MANUAL

- The plug or go devil must be thick enough to prevent compressed air flow around the plug into the concrete.
- **The pipeline must not be disassembled until it has been completely relieved of air.** Be sure of this! (See Figure 63.)

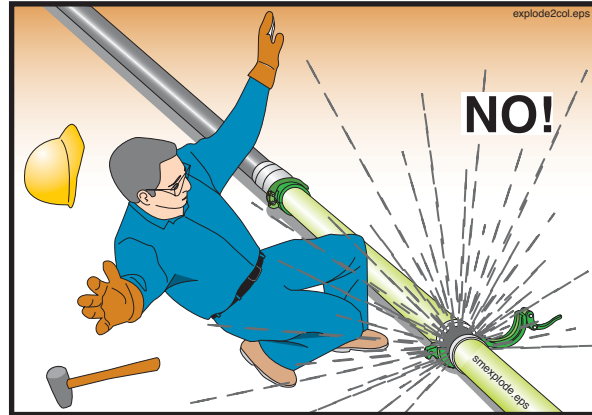

Figure 63
Never open a
pressurized pipeline

- **Do not use compressed air to blow out concrete delivery hose, single pipe sections and short pipelines up to a length of 40 feet.** Hoses will jump and move unpredictably; short pipelines don't have enough concrete to resist the force of the air, causing it to discharge too quickly, like a cannon (Figure 64).

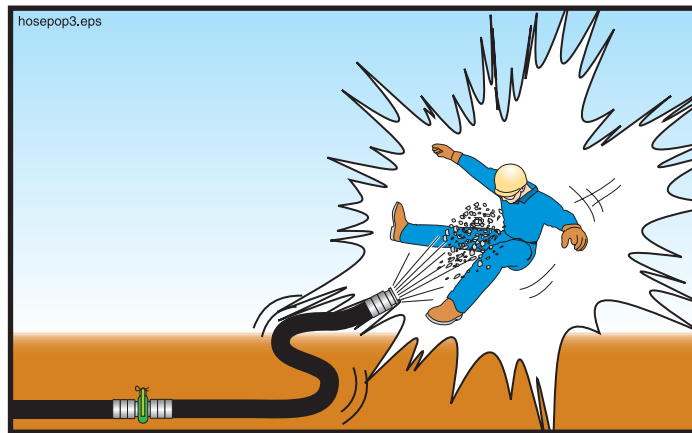

Figure 64
Never use air to blow out
hoses or short pipelines

- **When air pressure begins to drop rapidly, shut off the air supply from the compressor, and immediately begin bleeding air out of the pipeline.** (The drop in pressure signifies that the pipeline is almost empty of concrete.)

12.6



WARNING When blowing out a vertical line, a shutoff valve is required to prevent the following scenario.

1. (See diagram A in Figure 65.) Without a shutoff valve installed, the pipeline is disconnected from the pump. Immediately, the concrete drains out of the vertical sections of pipe, leaving concrete in both horizontal sections, and air trapped in between.
2. (See diagram B in Figure 65.) The ball is inserted, and pushed with compressed air. This also compresses the air that is trapped in the vertical sections

of pipe. The trapped air will be violently expelled when it reaches the end of the pipe, but the pipe will not yet be empty.

A shutoff valve installed at the bottom of the vertical run will prevent this hazardous situation. The shutoff valve must be capable of handling the maximum concrete pressure of the pump and, of course, must be installed before the pour begins. Several different styles are available, ranging from a manually operated flat gate that is put into place with a hammer to fully hydraulic types that will also divert the concrete to a different pipeline. With a shutoff valve installed, you can proceed as indicated below.

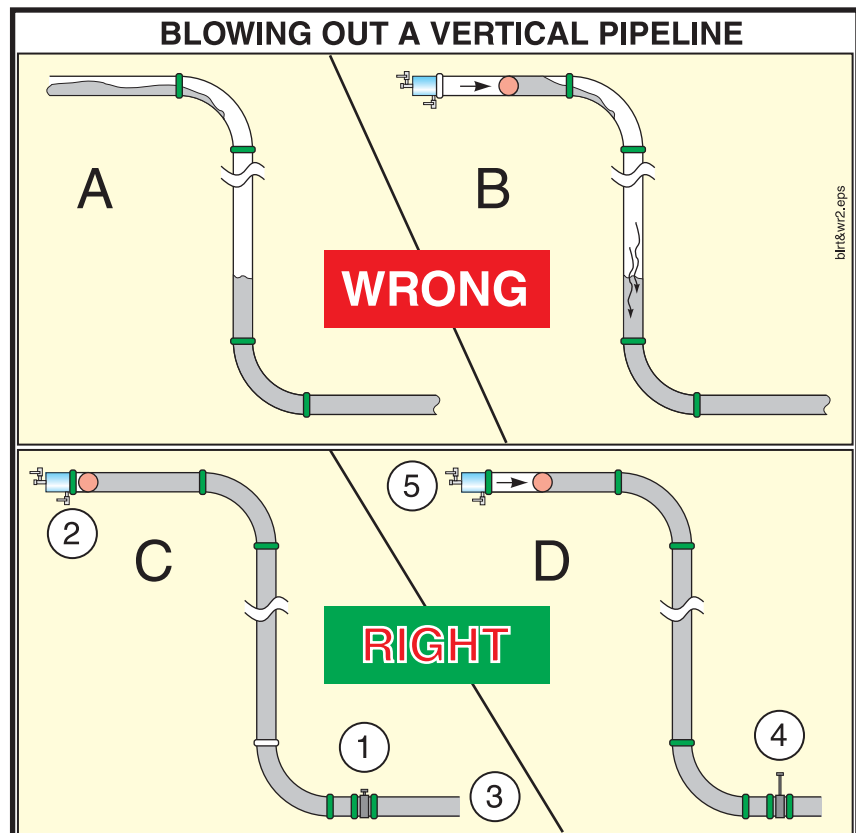

Figure 65
Blowout of a vertical line

12.7

⚠ WARNING Blowing out vertical sections of pipe (for example on a high rise building) requires additional safety precautions.

1. **Know where the discharge area for blowing out will be before the pour begins.** Ready the area and accessories before the pour begins so you will not waste time when pumping is completed.
2. **Blowing out with compressed air requires two qualified persons.**
3. **The persons at both ends of the pipeline must be able to communicate without delays,** which means you must establish communications (for example, with a radio).

SAFETY MANUAL

4. **When pumping is complete, close the shutoff valve before disconnecting the pipeline from the pump** (item 1, Figure 65). Failure to do this will cause the concrete to fall out of the vertical sections of pipe, leaving concrete in the horizontal sections of pipe and an air pocket in the vertical sections. This does not apply if you are using a switching (diversion) valve.
5. Install the ball(s) in the pipeline, secure the blow out head and hook up the air compressor. **Do not apply the air yet!** (Item 2, Figure 65.)
6. If you will be diverting the discharge to a cleanout area, lubricate the discharge line with slurry, or a plug could occur.
7. **Position the ready mix truck at the cleanout standpipe,** or install the ball catcher or other containment device at the end of the discharge line. (Item 3, Figure 65.)
8. **Clear the discharge area of personnel.** You must allow no one to enter the discharge area until the pipeline is depressurized.
9. **Divert the vertical pipe line to the clean out area, or open the shutoff valve in the delivery pipe line now.** (Figure 66.) Allow gravity to start the concrete moving through the discharge line. As the concrete falls from the vertical sections, it will take the ball with it, making it impossible to trap air in the line. (Item 4, Figure 65.)

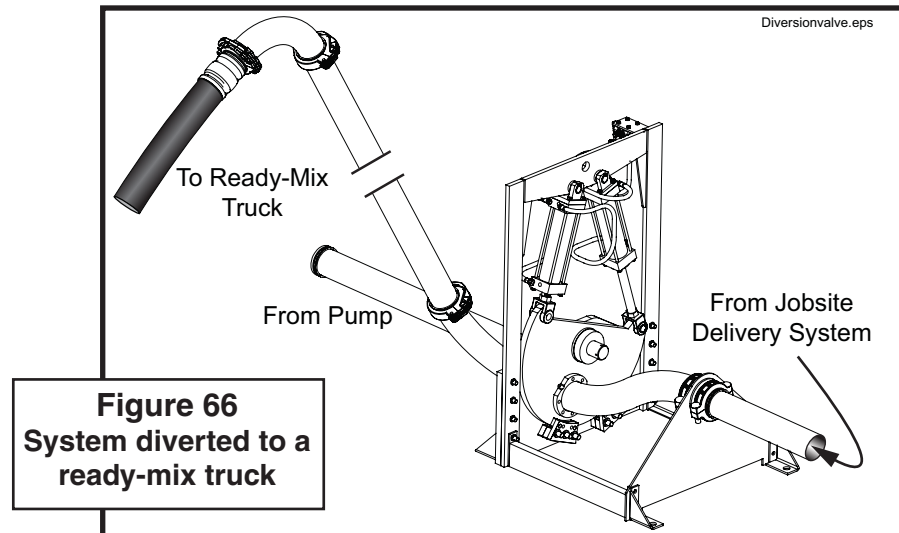

10. **Apply the compressed air to the pipeline.** Close communications must be maintained at this time. Add only enough air to keep the concrete moving. Do not allow the concrete to accelerate. (Item 5, Figure 65.)
11. **When concrete starts to accelerate, shut-off the air supply from the compressor, and open the air regulator to bleed air from the line.** Rapidly accelerating concrete indicates that the pipeline is almost empty. After the ball has been expelled from the pipeline, leave the air regulator open to be sure that all air is removed from the system.
12. All the rules for blowing out found in point 12.5 on page 49 also apply to blowing out a vertical pipe line. These rules are in addition to the general “cleaning a pipeline with compressed air” rules.

V. Maintenance Of The Machinery

13. Safety Rules Regarding Inspection

- 13.1 **⚠ WARNING** It is imperative that your boom, outriggers, and other structural members be inspected by a certified boom inspector on a regular basis. The results should be documented carefully and a record kept. Consult the manufacturers recommendations for the proper interval for your machine.
- 13.2 **⚠ WARNING** Visually inspect your unit each day before it is put into operation. If any problem is found that will affect the safe operation of the pump, don't use the pump until it is repaired!
- 13.3 **⚠ WARNING** Any structural problem found on the placing boom, outriggers, or tower section of the unit should be reported to the manufacturer so that proper repair procedures can be designed and implemented.
- 13.4 **⚠ WARNING** If safety decals are faded, missing, damaged, or otherwise unreadable, they must be replaced immediately. Contact the manufacturer of your unit to obtain replacements.
- 13.5 **⚠ WARNING** If safety devices or guards are removed for inspection purposes, they must be replaced before someone uses the machine.
- 13.6 **⚠ WARNING** Pay attention to the operation manual and manufacturer's service bulletins regarding maintenance and inspection procedures and intervals.
- 13.7 **⚠ WARNING** If structural inspection reveals something that looks wrong, or even suspicious, report it to the manufacturer for consideration. Don't just assume that it's OK.
- 13.8 **⚠ WARNING** Inspect the tip hose safety cable and mounting hardware on a regular basis. Replace it if it becomes old, frayed, or rusted.
- 13.9 **⚠ WARNING** Inspect the boom tie down and boom rest assemblies regularly (if your unit is so equipped). The boom must not be allowed to bounce during travel.
- 13.10 **⚠ WARNING** Visual inspection of the concrete pump circuits and safety devices should be done daily. Hands on inspection and documentation of results should be done weekly, or at least when preventive maintenance is scheduled.

SAFETY MANUAL

13.11

⚠ WARNING Do not neglect the delivery pipeline, clamps, or hoses. Check them often for wear, dents, and frays. Never send a unit to a job with a worn or damaged delivery system. For single-wall pipes, ultrasonic thickness testers are more accurate than the tap method (see Figure 67). Double-wall pipe are not inspected in this way.

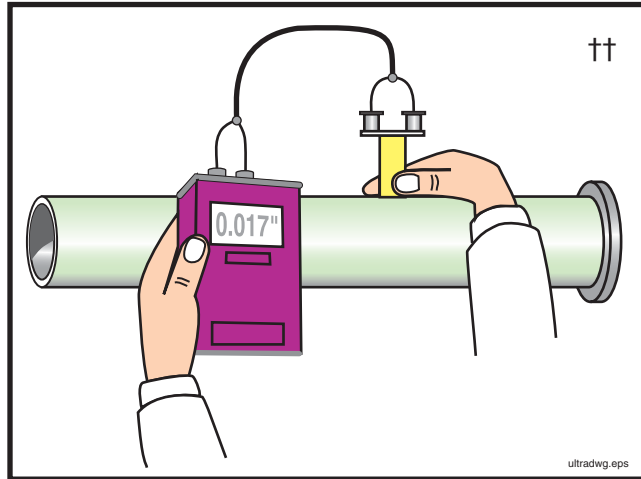

Figure 67
Check single-wall delivery system wall thickness with an ultrasonic thickness tester

14. Safety Rules Regarding Scheduled Maintenance

14.1

⚠ WARNING Proper and timely maintenance is important to the safe operation of a concrete pump and placing boom. The proper procedures are outlined in the operation manual supplied with the pump. Do not put it off. Do not treat it lightly. Do not “fudge” results. The lives of the operator, oiler, and workers on the job are depending on it.

14.2

⚠ WARNING Keep the machine clean! Oil spills, grease, loose tools, and displaced accessories are hazards.

14.3

⚠ WARNING Pins should be used on all delivery system clamps. Clamps that will hang over workers, and clamps used on system that will be dragged shall be pinned (Figure 68).

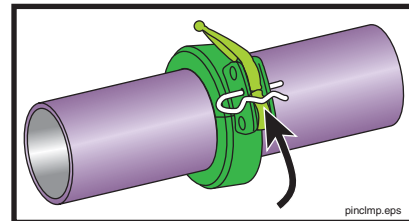

Figure 68
Pin the clamps

- 14.4 **⚠ WARNING** Be sure that you are installing the correct clamps for the types of pipe ends used. Never try to mate dissimilar pipe ends unless using a clamp specifically made for this purpose. See the comparison regarding weld-on ends on page 74 in the Appendix of this manual.
- 14.5 **⚠ WARNING** When installing new pipe and/or hose on the machine be sure that it is capable of handling the maximum concrete pressure of the pump.
- 14.6 **⚠ WARNING** Remember that boom pipe cannot weigh more than the manufacturer's specification for weight per foot. Check data tags on individual pieces and the pump to confirm compliance.
- 14.7 **⚠ WARNING** If safety devices or guards are removed for servicing, they must be replaced before the machine is put back in service.
- 14.8 **⚠ WARNING** Do not change the maximum relief valve setting on any hydraulic circuit without permission from the manufacturer. **Never** change an accumulator circuit pressure setting without specific instructions from the manufacturer.
- 14.9 **⚠ WARNING** Never make unauthorized modifications to structural members or pressure circuits.
- 14.10 **⚠ WARNING** You must **replace, not repair** damaged hydraulic or concrete hoses or pipes.
- 14.11 **⚠ WARNING** Never try to repair a machine using worn, damaged, or defective components.
- 14.12 **⚠ WARNING** Welding on the boom, outriggers, tower, or any other structural member may be done **only** by a welder certified to the manufacturer's specifications.
- 14.13 **⚠ WARNING** Welding on any structural member must be done according to the manufacturer's specifications.
- 14.14 **NOTICE** **Never allow welding current to travel through bearings or hydraulic cylinders.** Keep the ground cable on the component that is being welded.
- 14.15 **NOTICE** **Electronic components can be destroyed by welding current.** Before welding on the unit, you must disconnect the battery cables, and unplug all radio remote control power wires. If you have a proportional boom system, the proportional amplifiers must be removed from the mother board before welding. If in doubt, contact the service department of the manufacturer for instructions **before** proceeding.

15. Safety Rules When Servicing The Machinery

- 15.1 **⚠ WARNING** Repairs should be carried out by **qualified workshop personnel** (See the glossary for the definition of *qualified personnel*.)

SAFETY MANUAL

- 15.2 **⚠ WARNING** Read and understand the maintenance procedures in the *Operation Manual* of the machine before attempting any repairs. If in doubt, call the manufacturer. Incorrectly done repairs affect the safe use of the machine.
- 15.3 **⚠ WARNING** Burn hazard! Never work on a hot hydraulic system.
- 15.4 **⚠ WARNING** If it is necessary to unfold the placing boom to do maintenance work, the outriggers must be extended and jacked, just as if the machine were on a job site. If you are not an operator, have the operator set up the machine for you. The need to repair the machine does not qualify you to operate the machine.
- 15.5 **⚠ DANGER** Electrocution hazard! If it is necessary to unfold the placing boom to do maintenance work, you must watch for overhead power lines. You must maintain a minimum of 17 ft. (5 meters) clearance between the power line and any part of the unit (see Figure 69).

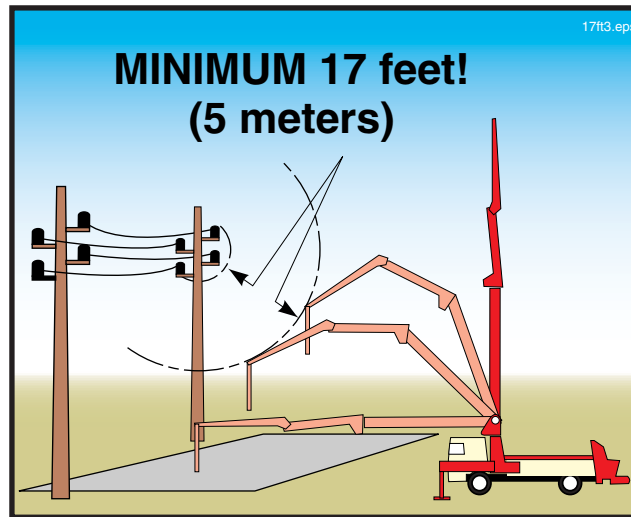

Figure 69
Watch for power lines if you must unfold the boom

- 15.6 **⚠ WARNING** Falling hazard! If you cannot work at ground level, you must find and use a suitable work platform, a tie-off harness system, or otherwise secure yourself from falling.
- 15.7 **⚠ WARNING** If maintenance work requires that you use a crane, hoist, fork truck, or similar machine, read and understand the safety regulations for that equipment. Remember, **the boom may not be used as a hoist or crane!** (See Figure 70.)
- 15.8 **⚠ WARNING** Crushing hazard! Secure the placing boom and relieve all pressure before working on the boom hydraulic system.

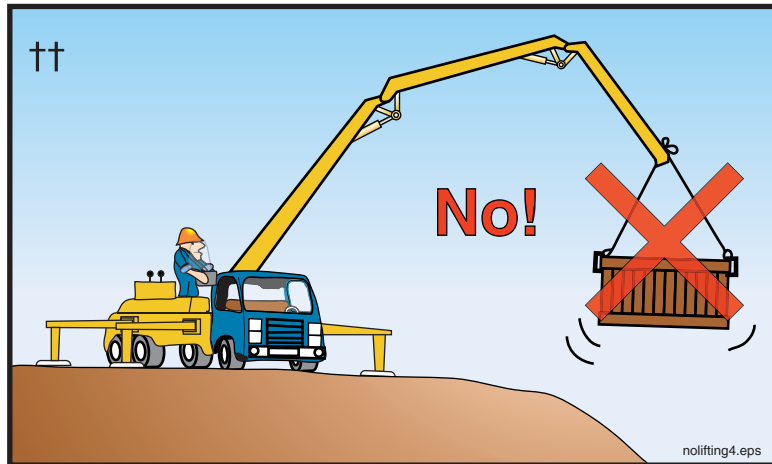



Figure 70
No lifting with the boom

- 15.9** **⚠ WARNING** Only operators should operate the unit. If work on the machine requires that it be operated and you are not qualified as an operator, you must get someone who is qualified to assist you.
- 15.10** **⚠ DANGER** Electrocution hazard! **Repair work on high voltage electrical systems must be done by qualified electricians.** For this rule, high voltage means anything over 24 volts.
- 15.11** **⚠ WARNING** Explosion hazard! **Be sure that you understand the potential danger of spring loaded or compressed gas components before you service them.** (Examples: nitrogen accumulators, gas springs for toolbox doors, tires, brake chambers.) If you don't know the dangers, call the manufacturer **before** beginning work!
- 15.12** **⚠ WARNING** If you will be working in a hidden area inside the machine, lock it out as follows.
- With a gas or diesel engine, remove the ignition key and place a *Do Not Operate* sign on the controls. Carry the key with you.
 - With an electrically driven pump, lock out the main breaker and tag the controls.
- The above rules are one simple “Lock Out-Tag Out” procedure. A procedure may also be provided in the operation manual for the unit and there may be state or local regulations that require a more advanced or stringent Lock Out-Tag Out program. Be aware of the regulations in your area.
- 15.13** **⚠ WARNING** Never activate the system hydraulics without checking if another workman is in a hidden position. Always yell “clear” before starting the engine or electric motor, and allow time for response.
- 15.14** **⚠ WARNING** Never work on a pressurized hydraulic system. Stop the engine or electric motor and relieve the accumulator circuit (if so equipped) before you open the hydraulic system.

SAFETY MANUAL

- 15.15**  **WARNING** Never use gasoline or diesel fuel as a cleaning solvent. This is critical to remember when cleaning hydraulic oil reservoirs, because gas and diesel fuels are highly explosive and **traces left in the oil may ignite when compressed!**
- 15.16**  **WARNING** Remember to mount and dismount the unit using the “3 Point Rule.” One hand and two feet or two hands and one foot are to be in contact with a secure surface at all times (Figure 71).

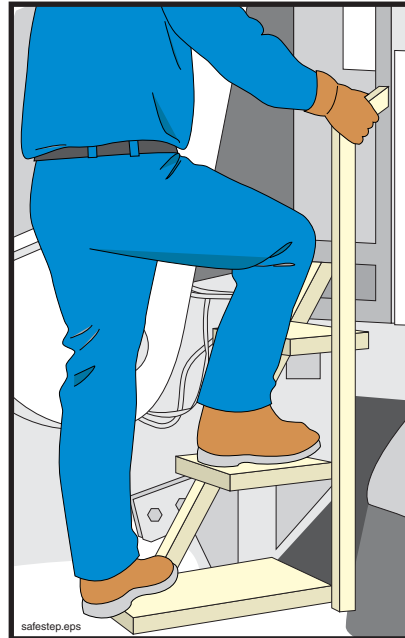





Figure 71
The 3 Point Rule

- 15.17**  **WARNING** **Inspect the repairs.** After modifications to structural members (boom, outriggers, tower, etc.) the repair must be inspected by qualified personnel before use.
- 15.18**  **WARNING** **Always use the correct tools for the job.** Tools should be kept clean and in good condition.
- 15.19**  **WARNING** If you see a co-worker engaging in an unsafe practice, warn him about the dangers. Safety is always in the hands of those on the job!
- 15.20**  **WARNING** After any repair is completed, test the function of the repaired part to be sure that repairs were done correctly.

VI. Co-worker Safety

16. Safety Rules For Workers Assigned To The Pump

- 16.1 **WARNING** You must know how to stop the pump and boom. Have the operator show you the locations of the emergency stop switches (Figure 72).

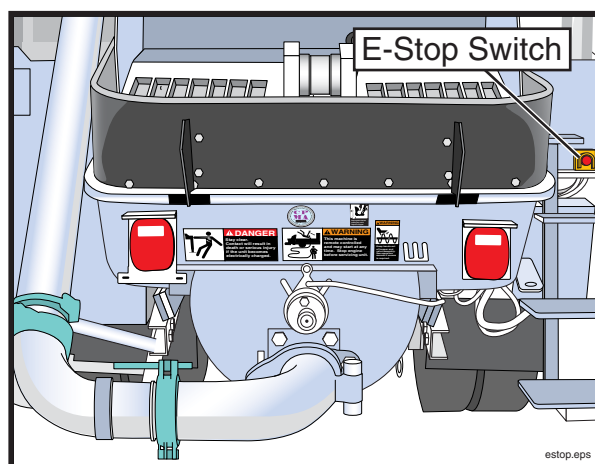

Figure 72
Know how to stop the unit in an emergency

- 16.2 **WARNING** You should wear the same personal protective equipment (PPE) as the operator. Goggles, hard hat, ear protection, and rubber gloves are especially important when working near the hopper (Figure 73).

* Breathing mask needed when cement dust (or other toxic dust) is present in the air.

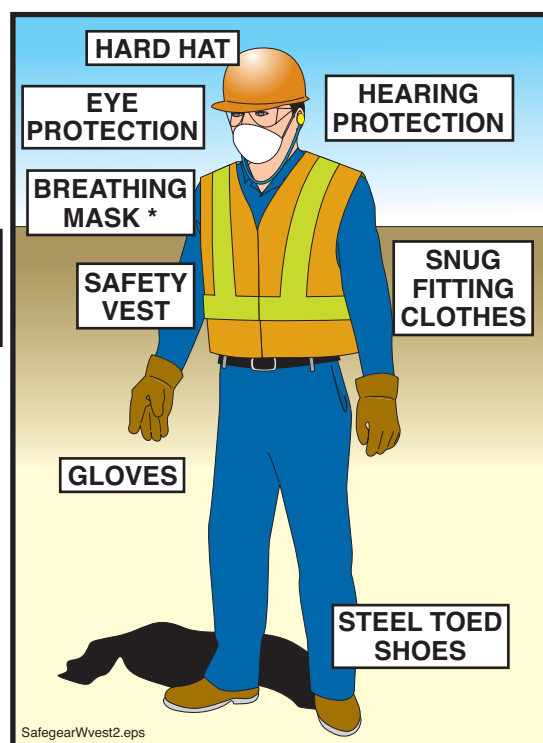

Figure 73
Wear the same personal protective equipment as the operator

SAFETY MANUAL

16.3

⚠ DANGER **Electrocution hazard!** If the pump or boom becomes energized with high voltage and you are in contact with **any** part of it, you are at **risk of electrocution!** You should monitor the movement of the boom and **alert the operator** if the boom comes within 17 feet of an electrical wire. (See Figure 74.)

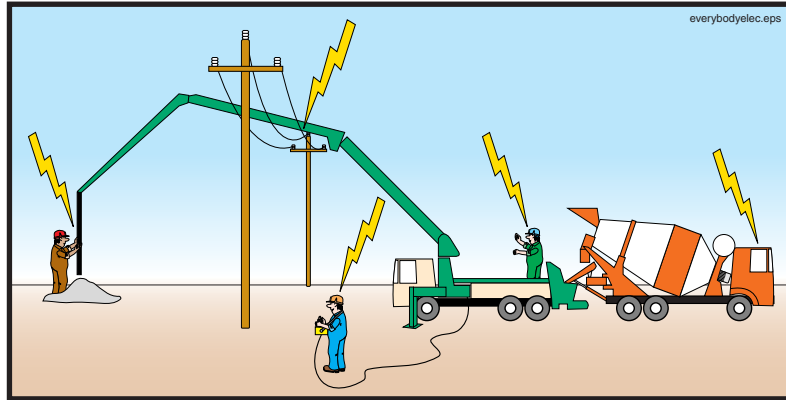

Figure 74

If the pump becomes energized, everything that touches the pump is also energized

16.4

⚠ DANGER When overhead wires are in the area that the boom will be moving to complete a pour, a spotter must be employed whose only job is to warn the operator if the boom comes within 17 feet of the wires. The spotter must understand the responsibilities assigned, and must be able to judge a 17 foot distance.

16.5

⚠ WARNING Keep an eye on the movements of the boom, even when there are no electrical wires nearby. Alert the operator if the boom is nearing any obstruction or hazard. Where job site safety is concerned, two sets of eyes and ears are better than one.

16.6

⚠ WARNING **Crushing hazard. Never, ever position yourself between the ready mix truck and the pump!** Stand to the side, where the driver can see you (Figure 75).



Figure 75

Never stand between the ready mix truck and the pump

16.7

⚠ WARNING When backing in ready mix trucks, use clear and concise hand signals (Figure 76).

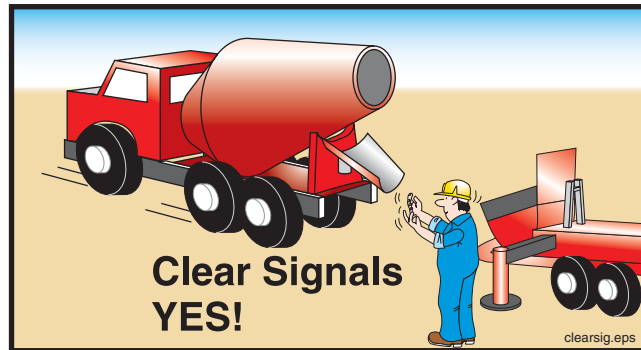

Figure 76
Use clear, concise hand signals

16.8

⚠ WARNING If handling the chutes of a ready mix truck, keep your hands clear of the hinged areas.

16.9

⚠ WARNING Do not allow the ready mix driver to put concrete in the pump hopper until the pump operator gives him the OK. Filling the hopper early can cause the pump to plug.

16.10

⚠ WARNING If you see foreign material that could create a blockage coming from the ready mix truck, alert the operator to stop the pump. Do not attempt to remove the material from the hopper or grate while the hydraulic system is ready to work. (See point 16.19 on page 64.) If necessary, depress the E-stop button to stop the pump and alert the operator.

16.11

⚠ WARNING Never allow the ready mix driver to clean out in the hopper, because it can create a blockage. (Water will wash the cement and fine sand from the course aggregate causing segregation.)

16.12

⚠ WARNING Do not operate the pump or boom unless you are also a trained operator and the regular operator has released the controls to you. **There must not be more than one operator at a time.** This does not apply to stopping the pump or boom if there is a need to do so.

16.13

⚠ WARNING Do not let the concrete level in the hopper become low! If air is sucked into the material cylinders, the pump will compress the air. Compressed air always poses a hazard as it is expelled from the hopper or the delivery pipeline (Figure 77). If air is taken into the material cylinders, take the following steps to minimize the hazard:

1. Stop the pump immediately. Hit the emergency stop button if that is the quickest way to stop the pump. There will be an expulsion of compressed air the next time the concrete valve shifts. If possible, fill the hopper with concrete to help contain the expulsion. Do not put your face directly over the hopper.

SAFETY MANUAL

- Alert the operator of the problem. It is his job to know the procedures for safe removal of air from the pump and delivery system. These procedures include pumping in reverse for a couple of strokes.
- Persons standing at the discharge end or near the delivery line must be warned to move away until all of the air has been purged. Warn them to stay a reasonable and prudent distance beyond the reach of the end hose or point of discharge (Figure 77).
- When the pump is restarted, don't assume that the first little air bubble is the end of the compressed air.
- Do not allow anyone near the discharge until concrete runs steadily from the end and there is no movement of the delivery system.
- If workers are positioned in high or precarious places, warn them to expect a loud sound as the air escapes the pipeline. (Warn them even if they are well away from the discharge.) That way, we can prevent the worker from falling as a result of being startled by the noise.

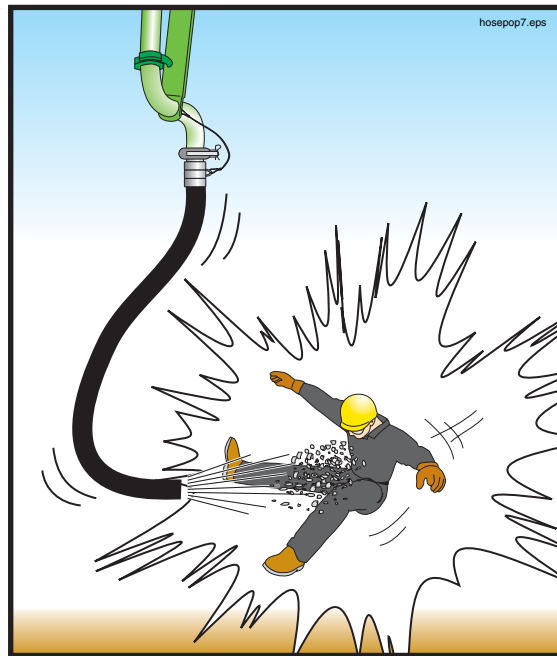

Figure 77
Remove everyone from the discharge area whenever the pump is first starting, restarting after moving, or if air has been introduced into the line

16.14

⚠ WARNING When initially priming the delivery system, when restarting after moving, when restarting after adding or removing hoses, or whenever air has been introduced into the line, warn everyone to stay away from the discharge until concrete runs steadily and there is no movement of the delivery system. Personnel should stay back a reasonable and prudent distance beyond the reach of the end hose or point of discharge (Figure 77). Air will be in the line when first starting,

when restarting after moving, when a blockage has been successfully removed by “rocking” the concrete, and after the line has been taken apart or opened for any reason.

16.15 **⚠ WARNING** **Never use compressed air to clear a blockage!** The operator is responsible for knowing the safe blockage removal procedures. It is unsafe and unnecessary to use compressed air. If the pump pressure can't move it, air pressure won't either.

16.16 **⚠ WARNING** **Never stand on, sit on, or straddle a pipeline while it's in use, or whenever it is pressurized.** Pipeline wears out with each stroke of the pump. If the pipe bursts, you want to be to the side of it, not on top of it (Figure 78).

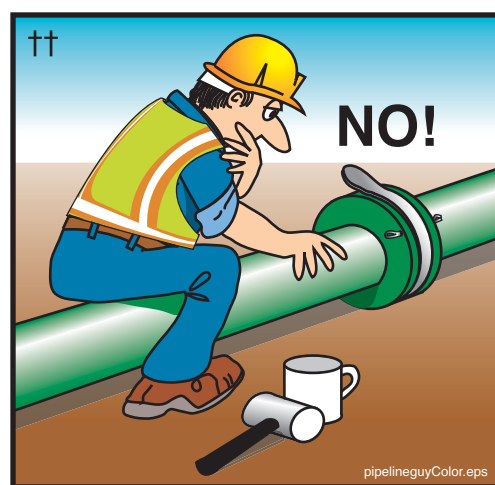

Figure 78
Never straddle or sit on a pressurized pipeline

16.17 **⚠ WARNING** **Expulsion hazard!** (See Figure 79.) **Never open a pipeline that is under pressure.** The pump must be run in reverse for at least two strokes and then stopped before opening a pipeline. If the pipeline is pressurized with air, do not open it. The operator is responsible for knowing how to safely release the air pressure.

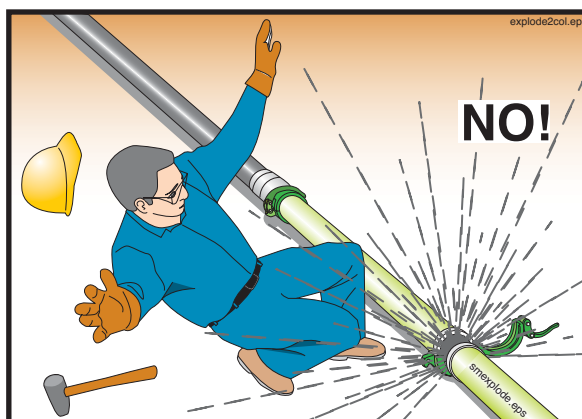



Figure 79
Never open a pressurized pipeline

SAFETY MANUAL

16.18  **WARNING** Be careful when handling pipeline or any other heavy object. Learn how to lift without using your back. Get assistance if needed.

16.19  **WARNING** Crushing/amputation hazard! Never put your hands, feet, or any other body part into the water box, concrete valve, or hopper when the hydraulic system is operational or ready to operate! Never stand on the hopper grate! (See Figure 80.)



Figure 80
Never put your body in the machine!

16.20  **WARNING** Never lift or remove the hopper grate for any reason (Figure 81).



Figure 81
Lifting hopper grate exposes the agitator and the concrete valve

16.21

⚠ WARNING Do not remove the water box covers or grates when the machine is stroking (Figure 82). Do not remove the water box cover (to add water, for example), until the operator has disabled the machine. Replace the covers before the operator restarts the pump.

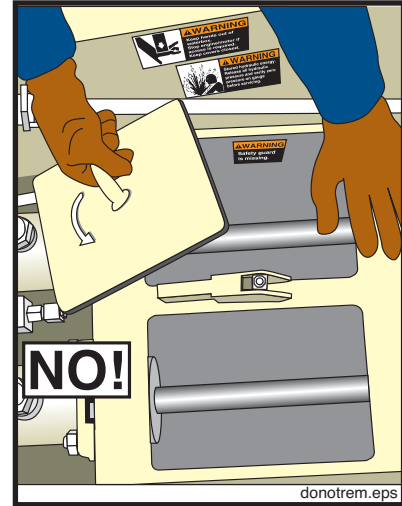

Figure 82
Do not remove the water box covers when the machine is stroking

16.22

⚠ WARNING Mount or dismount the pump or truck using the *3 Point Rule*. One hand and two feet or two hands and one foot are to be in contact with a secure surface at all times (Figure 83).

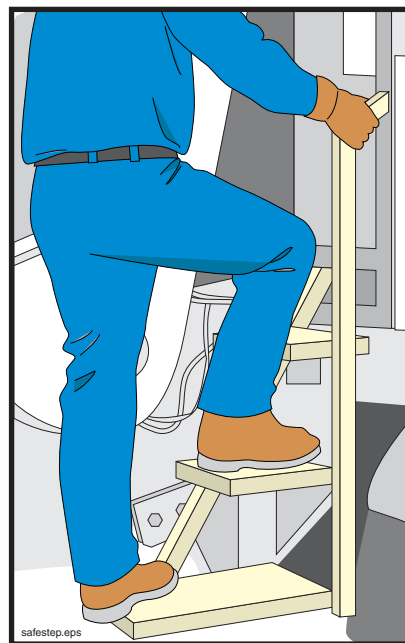

Figure 83
The 3 Point Rule

16.23

⚠ WARNING Keep unauthorized personnel off of the pump.

SAFETY MANUAL

17. Safety Rules For The Placing Crew

17.1

⚠ DANGER **Electrocution hazard!** If the pump or boom becomes energized with high voltage and you are in contact with **any** part of it, you are at **risk of electrocution!** You should monitor the movement of the boom and **alert the operator if the boom comes within 17 feet of an electrical wire.** (See Figure 84.)

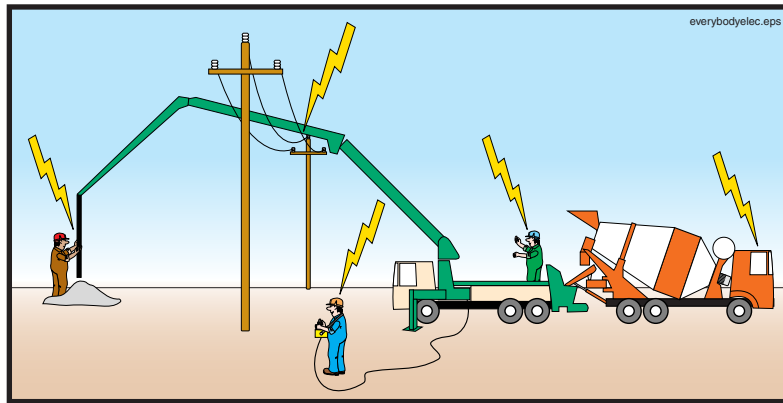

Figure 84
If the pump becomes energized, everything that touches the pump is also energized

17.2

⚠ DANGER When overhead wires are in the area that the boom will be moving to complete a pour, a spotter must be employed whose **only job is to warn the operator if the boom comes within 17 feet of the wires.** The spotter must understand the responsibilities assigned, and must be able to judge a 17 foot distance. (Figure 85.)

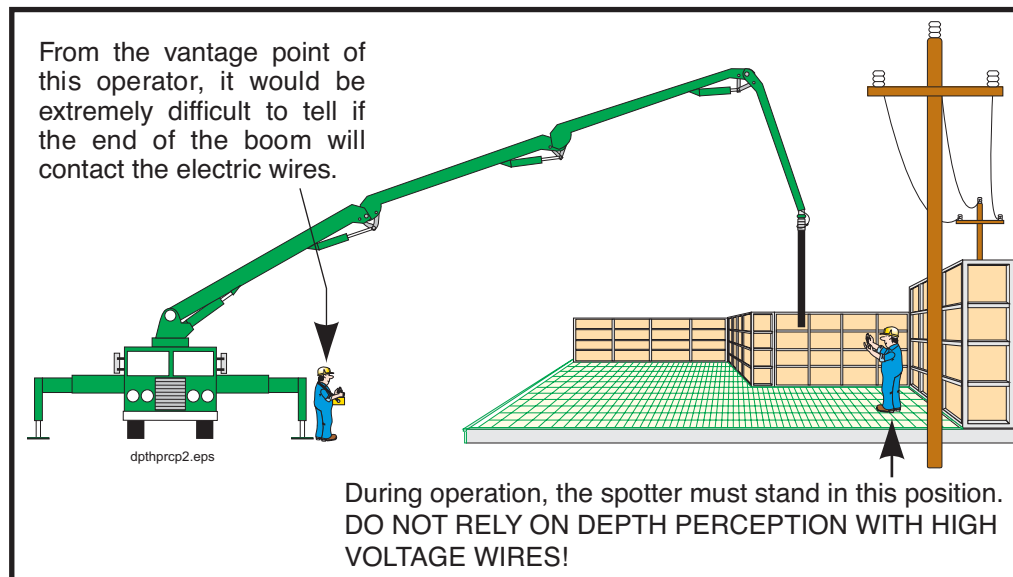

Figure 85
Use a spotter near obstructions or wires

17.3 **⚠ WARNING** Keep an eye on the movements of the boom, even when there are no electrical wires nearby. Alert the operator if he is nearing any obstruction or hazard. Where job site safety is concerned, two sets of eyes and ears are better than one.

17.4 **⚠ WARNING** Wear Personal Protective Equipment (P.P.E.) when working around a concrete pump (Figure 86). The gloves should resist concrete lime burns. If you will be working **in** the concrete, protect your feet and hands with rubber boots and gloves.

* Breathing mask needed when cement dust (or other toxic dust) is present in the air.

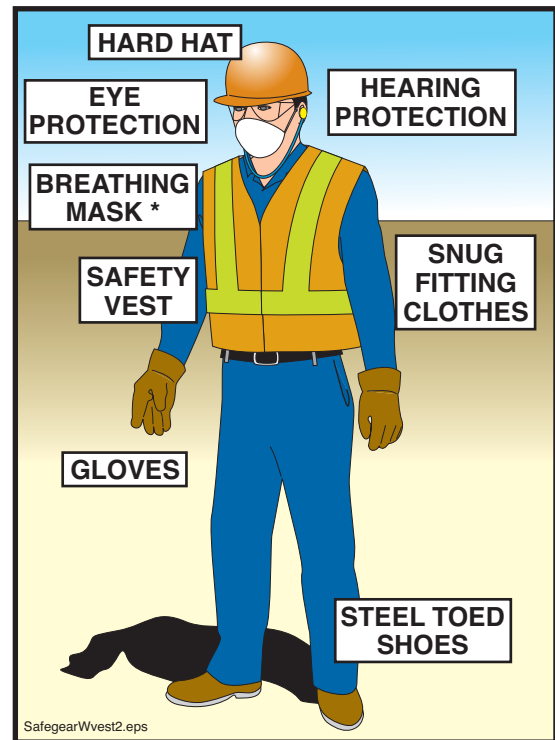

Figure 86
Wear Personal Protective Equipment (P.P.E.)

17.5 **⚠ WARNING** When the operator is initially priming the delivery system, restarting after moving, restarting after adding or removing pipes or hoses, or any time that air has been introduced into the delivery system, stand a reasonable and prudent distance away from the tip hose or point of discharge. Do not get near the discharge until material runs steadily and there is no movement of the delivery system. (Figure 87). Compressed air in the line can cause rubber hose to move violently. If the operator tells you that air is coming in the delivery system, proceed as follows:

- Get to ground level (if in a high place) and remain well away from the discharge or at least take cover.
- Stay away from the discharge. Be sure that **all** the air is gone before getting near the point of discharge again. It is the operator's job to know when it's safe to go back to normal pumping.

SAFETY MANUAL

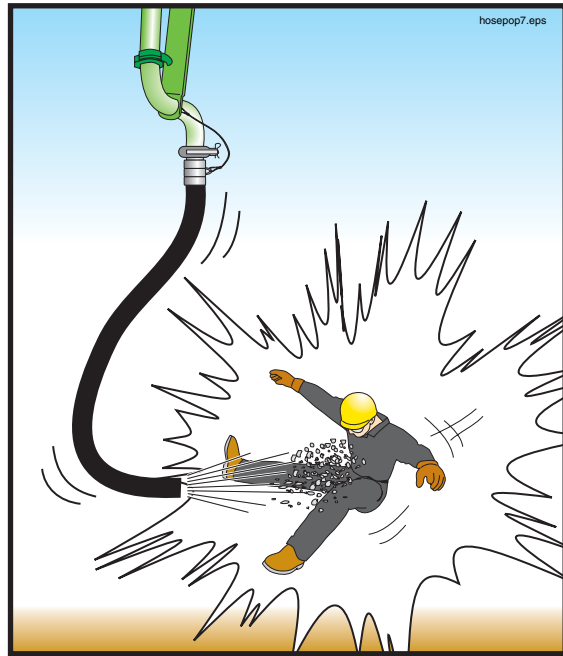

Figure 87
Stay away from the point of discharge when starting or restarting, and when there's air in the pipeline

- 17.6 **⚠ WARNING** Never use compressed air to clear a blockage! It is unsafe and unnecessary. If the pump pressure can't move it, air pressure won't either. Stand away from the discharge and the line if anyone attempts to use compressed air in this manner.
- 17.7 **⚠ WARNING** Do not look into the end of a plugged hose or pipe!
- 17.8 **⚠ WARNING** When the pump crew is using compressed air to clean the boom or system pipeline, stay away from the discharge area. **Never try to hold down a pipe or hose that is being cleaned with air.**
- 17.9 **⚠ WARNING** Never open a pressurized pipeline (Figure 88). The pump operator must release the pressure before you open the line. If the line is pressurized with compressed air, let the operator release the pressure and verify that the air has escaped before you proceed.

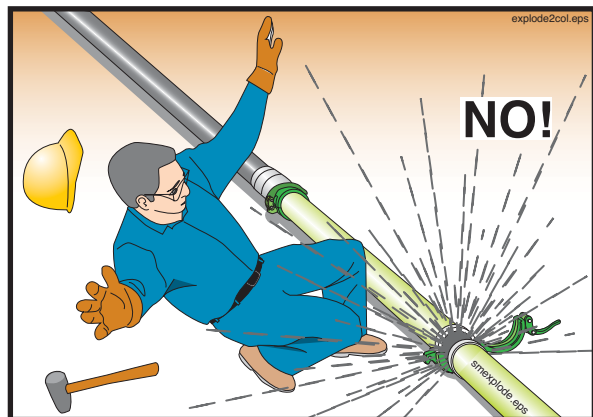

Figure 88
Never open a pressurized pipeline

- 17.10 **⚠ WARNING** After removing pipe sections you must **reassemble using gaskets and clamps**. Pipelines assembled without gaskets will leak cement and water, which can cause a blockage.
- 17.11 **⚠ WARNING** Concrete is being moved through the delivery system by pressure. Failure of a pipe, clamp, hose, or elbow is possible. For this reason, spend as little time as possible standing under the boom, and wear protective clothing.
- 17.12 **⚠ WARNING** The hose man should not hug the hose, but hold it with both hands, to allow the hose to move freely (Figure 89).



Figure 89
Do not hug the boom hose

- 17.13 **⚠ WARNING** The hose man should not walk backwards (Figure 90). Walking forward will allow him to see obstacles and avoid tripping.

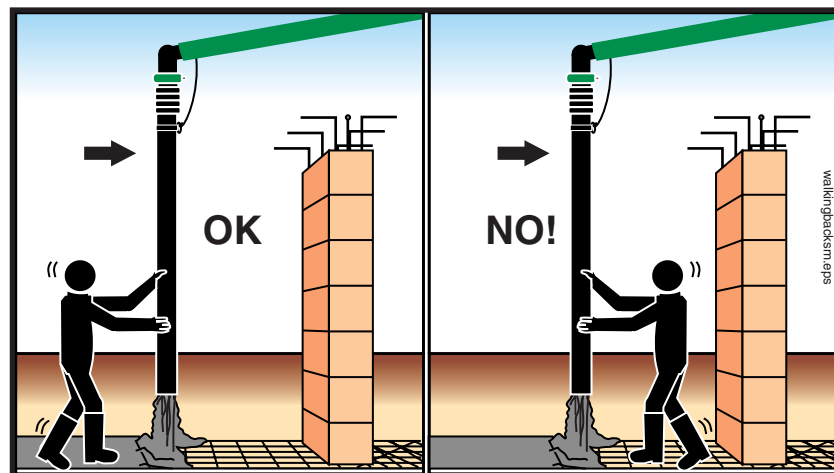

Figure 90
Do not walk backwards, stay out of the path of the boom

- 17.14 **⚠ WARNING** The hose man should never position himself between the boom or boom hose and any fixed object like a wall or column (Figure 90).

SAFETY MANUAL

17.15

⚠ WARNING Do not kink the end hose. Kinking will cause the pump to create maximum concrete pressure. The pump may unkink the hose by force! (See Figure 91.)

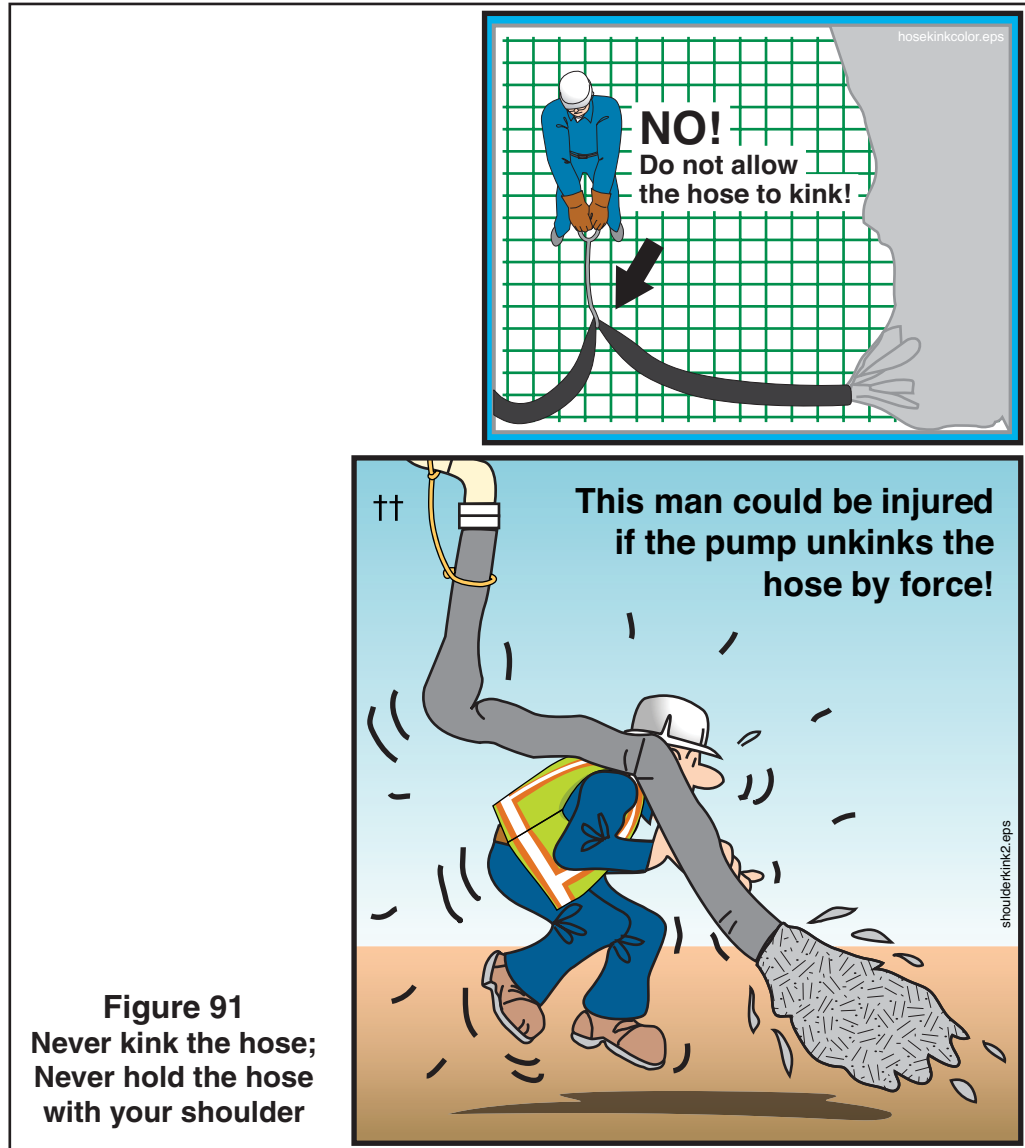

Figure 91
Never kink the hose;
Never hold the hose
with your shoulder

17.16

⚠ WARNING Never try to support the tip hose with your back or shoulders. Let the hose hang from the boom (Figure 91).

17.17

⚠ CAUTION Be careful when handling pipeline or any other heavy object. Learn how to lift without using your back. Get assistance if needed.

17.18

⚠ WARNING Crushing hazard! Never position your hands or any body part between the end of the delivery system and a fixed object (e.g., between the tip hose and the concrete form) (Figure 92). Watch for clamps lowering with the line, because they have a larger diameter than the pipes/hoses they connect.

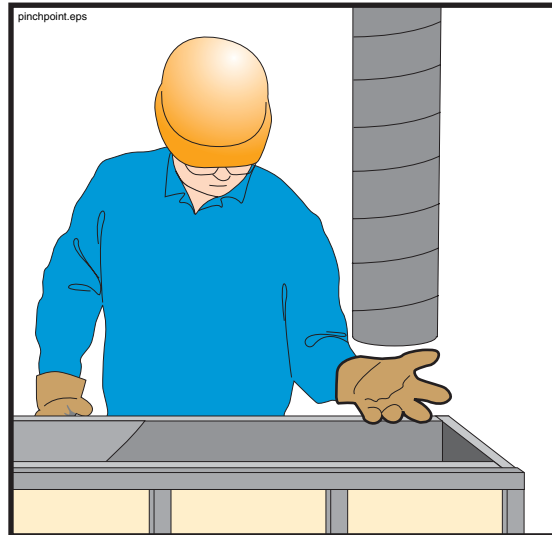

Figure 92
Watch out for the pinch points

17.19

⚠ WARNING Do not allow the boom hose to get lower than two feet above the deck to prevent the boom hose from hitting the feet of the hose man, and to prevent the hose opening from being blocked by the deck, which could cause the hose to whip.

17.20

⚠ WARNING Falling hazard! When pouring columns, slabs, or walls above ground, secure yourself from falling.

17.21

⚠ WARNING Never stand on, sit on, or straddle a pipeline while it's in use, or whenever it is pressurized (Figure 93). Pipeline wears out with each stroke of the pump. If the pipe bursts, you want to be to the side of it, not on top of it.



Figure 93
Never straddle or sit on a pressurized pipeline

SAFETY MANUAL

17.22 **⚠ WARNING** To avoid confusion and conflicting signals, only one person should signal the pump operator except for the stop signal, which may be given by anyone.

17.23 **⚠ WARNING** Before the pour begins, the hose man, the operator and the spotter should agree on the hand signals (Figure 94).

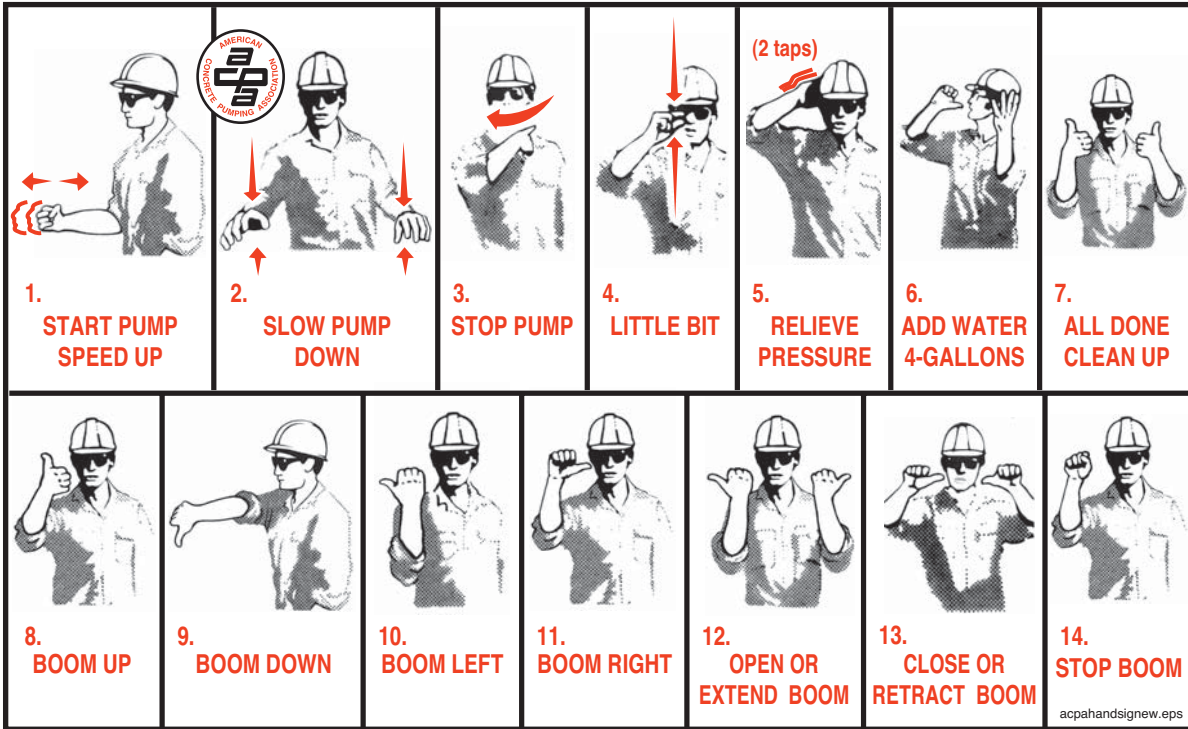
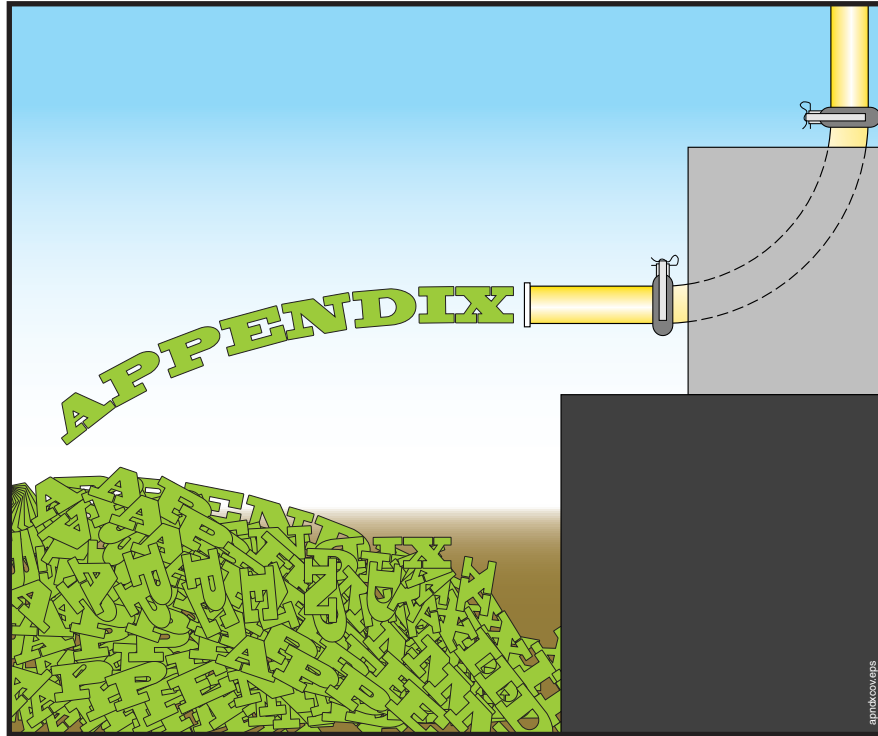

Figure 94
ACPA recommended hand signals



Appendix Table of Contents

VII.	Weld On Ends / Coupling Comparison	74
VIII.	Minimum Pipe Wall Thickness Chart	75
IX.	Glossary Of Terms	76
X.	Recommended Hand Signals	82
XI.	Bibliography	82

A note regarding the pipewall thickness chart: Some printed instructions lead you to page 73 of the Safety Manual to find the Minimum Pipewall Thickness chart. Due to expanding graphics, that chart has moved to a later page in this book. You will always find it in the *Appendix* section of the Safety Manual.

SAFETY MANUAL

VII. Weld On Ends / Coupling Comparison

Shown is a comparison among commonly used ends/couplings. No two ends shown can be joined without the use of an adapter pipe or a special adapter clamp. Clamps and pipe strength must also be considered when determining proper system requirements. The ratios shown in the text below represent the safety factor from burst : working

1. Male / female o-ring type couplings have the highest pressure rating of the ends commonly used for concrete pumping. They can withstand 4350 PSI @ a 2:1 safety factor. They are self aligning and waterproof when used with o-rings in good condition. Typically not used on booms because of their weight. Pipes equipped with this style coupling cannot be swapped end-for-end.

2. Heavy-Duty couplings are designed for pressures up to 2250 PSI @ 2:1. They have 20% more contact area than metric couplings, and a tapered face that draws the pipe sections together during assembly. Both the ends and clamps weigh more than metric style, and therefore should not be used on booms without consulting the manufacturer.

3. Metric couplings are designed for pressures up to 1400 PSI @ 2:1. They have 85% more contact area than grooved couplings. The face is flat and will not draw pipe together. Although they have a raised edge, they are not compatible with Heavy Duty couplings unless a special clamp or an adapter pipe is used to change from one style to the other. Metric connections are standard equipment on booms because of the weight savings compared with other styles.

4. Grooved couplings (lip height of 0.15" or less) are designed for pressures only up to 750 PSI @ 2:1. The recessed groove is hard to clean when changing pipe on a job. The weld-on end fails before the pipe because the groove is cut into the pipe thickness, making it the weakest spot. Grooved couplings are not recommended for concrete pumping applications.

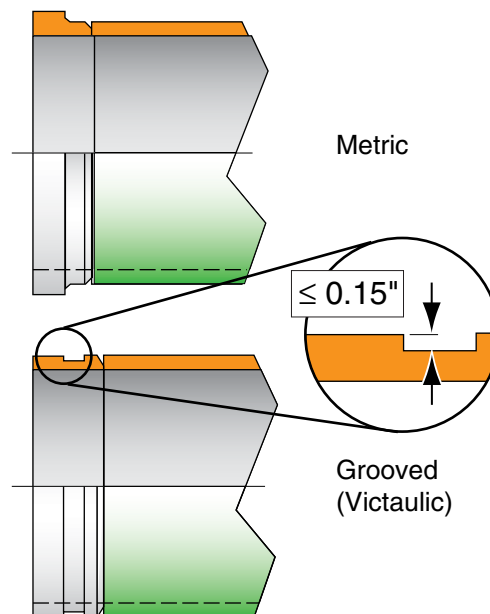
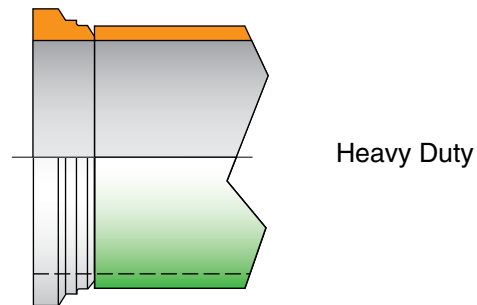
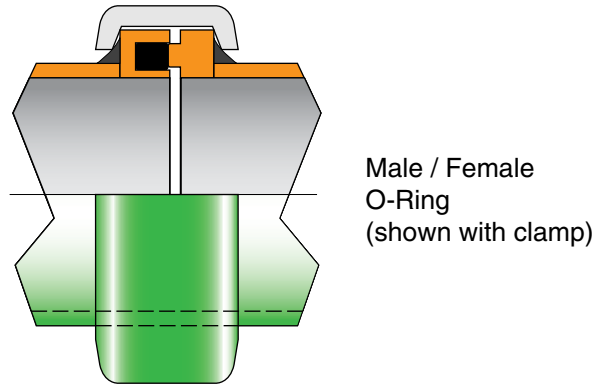

weldends4.eps

NOTE: All pressure ratings listed refer to 5 inch (125mm) diameters in like-new condition. Other pressures would apply to other sizes.

VIII. Minimum Pipe Wall Thickness Chart

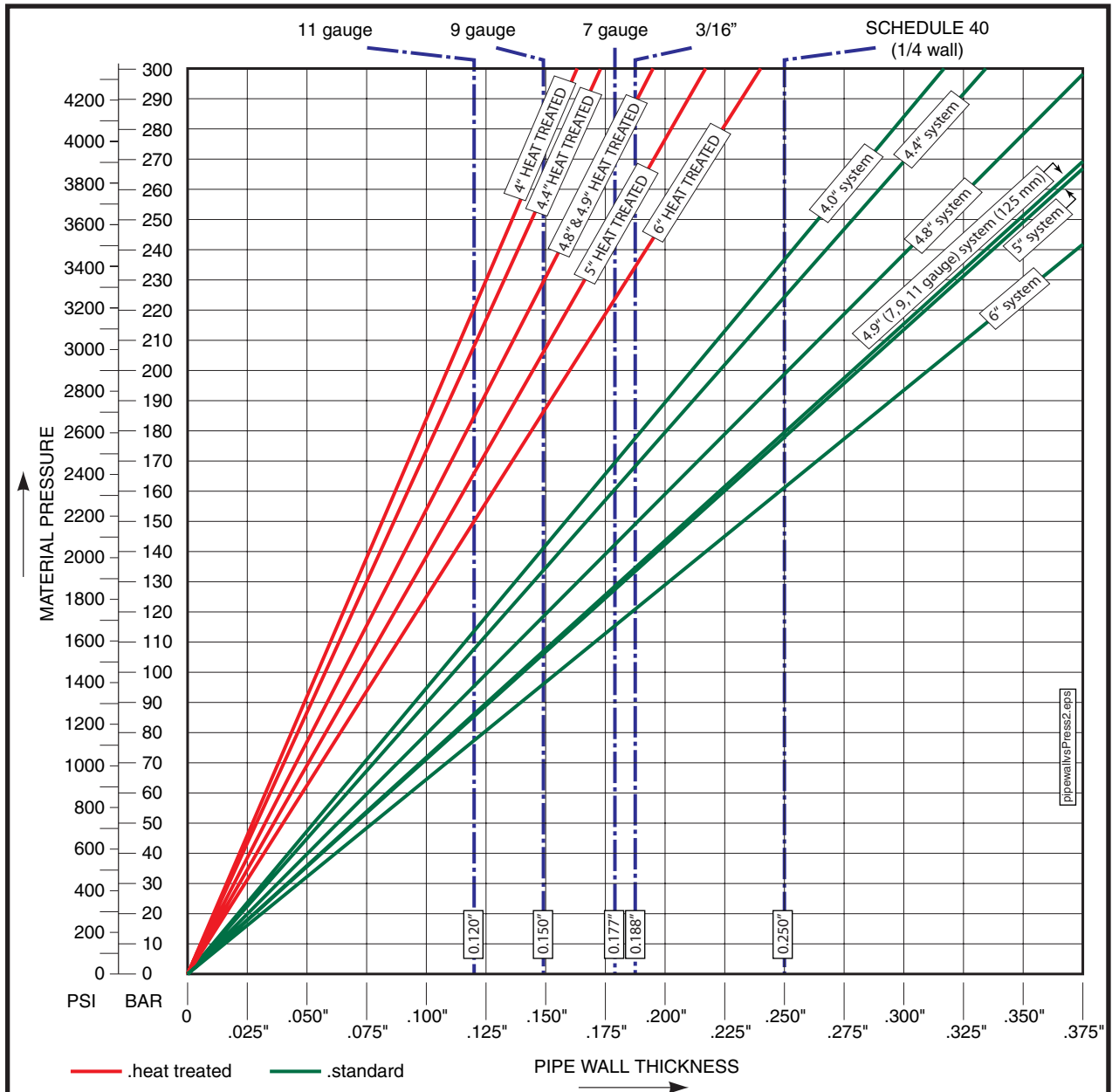

1. This chart assumes a safety factor of 2:1. Higher safety factors may be required in some circumstances.
2. Wear reduces wall thickness. Thickness must be checked on a regular basis.
3. Pressures may be limited even more by clamp style or pipe end used.
4. The chart is based on 62,000 PSI tensile strength. Heat-treated calculations are based on 120,000 PSI tensile strength.
5. The chart is for pressure calculations ONLY. There is no allowance for mechanical forces other than pressure, and thicker walls may be needed for mechanical strength because of support or restraint considerations.
6. The chart does not take into account metal fatigue caused by pressure cycles.

Note! This chart is intended as a guide for concrete pumping applications and is subject to the notes, assumptions, and conditions listed above. Any other use of this chart is not recommended.

This chart does not apply to double-wall pipe. Double wall pipe can be checked by inspecting the inside of the pipe. If the insert is intact, the pipe is okay. If the insert is worn through, the pipe must be replaced. Contact your pipe supplier for the pressure capacity of your double-wall pipe.

SAFETY MANUAL

IX. Glossary Of Terms

Accumulator

A hydraulic device that stores fluid power energy in much the same way that a battery stores electrical energy. Because an accumulator will store energy, it **MUST** be drained and depressurized before work begins on an accumulator equipped actuator or hydraulic system.

Agitator

A device that sits in the concrete hopper to keep concrete moving, preventing it from setting. It is typically a rotating shaft to which several paddles have been mounted. *See Also:* Hopper Grate

ASME B30.27i

A safety standard for material placement systems (concrete pumps and material placement conveyors) that has been accepted by ANSI as an American National Standard.

Blanking Plate

Also known as a blanking plug or end cap. It's purpose is to prevent material from falling out of the delivery system when moving a boom with a full pipeline over personnel or property.

Blockage

Simply put, if the pump is pushing and concrete fails to come out at the point of discharge, it is called a blockage. Blockages can be removed with pump pressure, by rocking the pump between forward and reverse, or some other remedial measure. If the blockage can not be removed in such a manner, it's called a plug. *See Also:* Plug, Rock Jam. The causes of blockages are detailed in section 8.21 of this manual. In all cases, blockages create a hazard by causing high concrete pressure, combined with the sometimes uncoordinated efforts of untrained workmen to remedy the problem.

Bulk Density

The mass of a substance per volume. For example, one cubic foot of air weighs much less than one cubic foot of water. One cubic foot of lightweight concrete weighs less than one cubic foot of steel entrained concrete. We could say that steel entrained concrete has a higher bulk density than lightweight concrete. All calculations for the operation manuals and specifications of concrete pumps are based upon 150 pounds per cubic foot, which is the approximate mass of hard rock (normal) concrete.

Certified Operator

An operator that has been issued a certification card by the American Concrete Pumping Association. There are several classes of certification, each relating to a different category of pump. For an operator to become certified, he (she) must pass the written tests regarding operation, setup, and clean out for each category of pump, pass the safety rules test which is common to all certification categories, meet the experience requirements set forth for each category, and maintain a safe and clean driving record. The certification card only certifies that the operator has passed a written test administered by an A.C.P.A. certification tester and does not attest to their ability to operate a concrete pump. *See Also:* Qualified Person, Qualified Operator.

Concrete Delivery Hose

A flexible concrete hose that has two end couplings.

Concrete Pressure

The force per square area that is exerted on the concrete. The concrete pressure will always be a ratio in direct proportion to the hydraulic oil pressure on the concrete pump circuit. *See Also:* Maximum Pressure

Conductors

Materials that will conduct electricity. Copper, silver, aluminum, gold, steel, and water are considered GOOD conductors of electricity. Air, fiberglass, rubber, ceramics and glass are considered POOR conductors. All of these conductors have a resistance to the flow of electricity that can be measured in terms of ohms per linear foot. As voltage gets higher, more current flows through the same resistance. In the case of high voltage electric wires (8000 volts, for example) even the poor conductors will carry enough current through your body to ground that you could be killed. (As little as 35 milliamps can cause fibrillation of the heart.) Some conductors, like air, resist electricity very well, but if the voltage gets high enough, current will flow (lightning is a good example of this). *See Also:* Electrocutation

Decibels

One tenth of a bel. Abbreviated dB. It is a measurement of sound volume. As it applies to concrete pumps, it is a measurement of the sound pressure level one meter away from a noise source. O.S.H.A. has developed guidelines for time limits on exposure to sound at different volume levels. The chart can be found on page 38 of this manual.

Drive Engine

The primary source of power for a hydraulic system. Typically, the word “engine” denotes an internal combustion device, whereas the word “motor” denotes an electrical device.

Electrocutation

Made from the words “Electric” + “Execution.” It means death by electricity. *See Also:* Conductors

End Hose

A flexible concrete hose that has one end coupling.

Foreign Material

Material that was never intended to be pumped, which ends up in the concrete hopper. Examples of foreign material include small animals, hammers, ready mix truck fins, unmixed clumps of cement, hardened concrete that breaks away from ready mix truck fins, and soda pop cans. These items could create a blockage if pumped.

Go Devil

A plug made from a rubber composite, usually with several fins that expand to seal when pressure is applied. They are intended to be inserted in a steel delivery pipeline and pushed with water or compressed air for the purpose of cleaning the pipe. *See Also:* Sponge Ball

Guide

An assistant brought in to help in backing up a truck or trailer, or to help in other circumstances where the driver cannot see enough to assure safety. *See Also:* Spotter

High Voltage

For the purposes of this manual, anything over 24 volts is to be considered high voltage. In the U.S., electrically driven concrete pumps normally operate the motors at 480 volts AC (high voltage) and the controls at 24 volt DC (low voltage). When dealing with electric wires in residential or industrial areas the voltage will be approx. 8000 volts to ground, or 13,800 volts from phase to phase (distribution voltage). When dealing with electric wires that are mounted on steel towers high above the ground, the voltage will range from 100,000 to 1,000,000 volts (transmission voltage).

Hopper Grate

A meshwork placed over the concrete hopper, typically made from steel bars. It serves the functions of keeping human body parts away from the agitator (when left in its proper position) and

SAFETY MANUAL

keeping large foreign objects from falling into the hopper, which could cause blockages if they were pumped.

Jacking the Outriggers

Adjustment of the outriggers in the vertical direction.

Licensed Electrician

A qualified electrician licensed by the state, county or municipality where the connections are to be made. In some locations electricians are not required to be licensed, and in these cases the work should still be carried out by competent professionals. Under no circumstances should high voltage connections be made by a concrete pump operator or related personnel.

Maintenance

All procedures for service, inspection, and repair of concrete pumps and related equipment and devices. Maintenance and inspection are methods of *maintaining* the desired state of the equipment. Repair is the method of *restoring* the desired state of the equipment.

Maximum Pressure

When talking about a hydraulic system, maximum pressure refers to the highest pressure that can be achieved with the settings of the circuit relief valves. When discussing concrete output, maximum pressure refers to the pressure that will be developed if the hydraulic system pressure reaches the relief valve setting. Concrete pressure is the force at which the differential cylinders are moving, divided by the cross sectional area of the concrete cylinder. Maximum concrete pressure, then, is developed when the differential cylinders are moving with maximum force, which is determined by the hydraulic system relief valve setting. *See Also:* Concrete Pressure.

Minimum Safety Distance

In this manual, the term “minimum safety distance” refers to the closest distance that you are allowed to approach an object, electrical wires, etc. and still leave room for errors in human judgement or machine malfunction. With electrical wires in the U.S., this distance is 17 feet, as recommended by the American Concrete Pumping Association. This distance may have other values in different locations. It is up to the operator to know the value for the place of operation.

Operational Area

The area around a working piece of equipment or point of discharge where hazards can be encountered due to the nature of the machinery or process in use.

O.S.H.A.

Occupational Safety and Health Administration. A branch of the United States federal government that deals with job safety. They establish and enforce safety regulations for industry and business. Among the areas over which they have authority are construction job sites and work shops.

Personal Protective Equipment (P.P.E.)

Things you can wear to protect yourself from potential dangers in a concrete placing environment. Examples are:

- Snug fitting work clothes
- Steel toed work boots
- Lime resistant gloves
- Safety glasses
- Ear muffs or ear plugs
- Rubber boots when you have to stand in concrete
- Hard hat
- Breathing mask when working with cement dust

Plug

A plug is a blockage that cannot be removed with the pump pressure, or by other remedial measures. A plug must be removed manually. *See Also:* Blockage.

Point of Discharge

Also known as the point of placement. The location of concrete expulsion from a delivery system. This can be the point of placement (the actual form that is being filled with concrete) or the clean out area after completion of the job.

Pour

Used by the concrete pumping industry and in this manual as a noun. It is the specific job for the pump during any given time period. (e.g. “We’ll grab lunch right after the pour.”)

Qualified Person

As used in this Safety Manual, a *qualified person* is defined as: a person who, by possession of a recognized degree or certificate of professional standing, or who by extensive knowledge, training, and experience, has successfully demonstrated the ability to solve or resolve problems relating to the subject matter and work. Other qualified persons may include master mechanics and after-sales service technicians of the manufacturer. *See Also:* Certified Operator

Qualified Operator

Operators shall be considered qualified when they have completed a program of training and supervised operation of concrete pumps and have passed a practical operating examination of their ability to operate a specific model and type of equipment as well as their understanding of the controls and operating procedures. Furthermore, the operator must meet the knowledge and physical requirement sections of the concrete pumping safety standard.

Qualified Personnel

A generic term used to describe a person who is qualified in the area of application. For example, having your boom repairs inspected by “qualified personnel” before use would refer to inspection by a certified welder or certified welding inspector. Having repairs to your hydraulic system done by “qualified personnel” would refer to repairs made by qualified workshop personnel.

Qualified Workshop Personnel

An individual who:

- has reached the age of 18 years,
- is physically and mentally capable,
- has been trained in proper repair, maintenance, and inspection procedures plus the pertinent safety rules for concrete pumps and related equipment,
- has demonstrated their capabilities to their company in regards to the above mentioned procedures and rules, and
- can be expected to perform these duties, as assigned, in a reliable manner.

Rock Jam

A specific type of blockage caused when the cement and fines of the concrete are not present in sufficient quantity to fully coat the larger aggregates and the walls of the delivery system. In these cases, the rock (larger aggregates of the mix) will form a wedge inside of the pipe. Resistance to movement then becomes overpowering and the concrete stops. *See Also:* Blockage.

Separate Pipeline

A pipeline that is laid between the concrete pump and the point of discharge, other than the placing boom pipeline.

Shutoff Valve

In hydraulics: a valve with the ability to stop the flow or pressure of hydraulic oil. It must be able to withstand the maximum pressure of the hydraulic circuit that it controls. In concrete: A manu-

SAFETY MANUAL

ally or hydraulically operated valve that will prevent the flow of concrete in either direction. The shutoff valve must be able to withstand the maximum pressure on the concrete of which the pump is capable of exerting.

Soil Pressure

The force per square area that is exerted on the ground by the outrigger legs. The amount of pressure that the soil will support varies with the composition and compaction of the soil. To make a determination on the stability of the soil, see the chart on page 23 of this manual.

Sponge Ball

A medium to hard sponge formed into a sphere and used to clean the inside of delivery pipelines.
See Also: Go Devil

Spotter

A spotter is a person who stands at a vantage point where he (she) can see both the point of discharge and the operator of the pump. The spotter would then direct the operator to operate the unit as required by the job circumstances with two-way radios or hand signals. A spotter can be anyone who is familiar with the safety rules for the pump and workers and is equipped with a radio or knows the appropriate hand signals. A spotter is needed whenever the operator cannot safely see the point of placement or the distance between the unit and an unsafe area. *See Also:* Guide

Sucking Back

The act of putting the concrete pump into the reverse mode for any of several reasons.

Thrust Block

Also known as a “dead man”. This is a large block of poured concrete, usually with one or more sweep elbows cast inside, placed at the bottom of a vertical run for the purpose of supporting the weight of the vertical run and for lateral stabilization of the pipeline. It stabilizes and supports the vertical run by virtue of its enormous mass (normally one cubic yard or larger).

Towing Vehicle

In this manual, *Towing Vehicle* applies only to vehicles that tow trailer mounted concrete pumps. It is the vehicle that you will use to tow the trailer on the road, on the job site, or in the yard. See the safety rules regarding this subject on page 11 of this Safety Manual.

Transport Position

This relates to the position of the boom when you will be driving the unit. The travel position of the boom is the position of the boom when it is completely folded and lowered into the rests.

Unauthorized

Without authority, without permission. Examples: Unauthorized operation of the boom could be operation by a passer-by, unauthorized repairs to the boom could be repairs designed without the manufacturer’s knowledge.

Unintentional Movement

Movement of the pump, boom or related equipment without a specific intentional command by the operator. An example of an unintentional movement would be if an operator fell while walking with the remote control box and accidentally hit a joystick, causing a boom movement.

Vertical Run

Sections of concrete delivery pipeline that are running in an up (or down) direction. Vertical runs have very specific procedures and rules for installation, support, cleaning, and inspection. Concrete pumping personnel should, therefore, have specific training in these procedures and rules before attempting to use them in a job setting.

Water Jet

The actual stream of water that comes out of the end of a water hose or pressure washer. This is the only part of the water system that needs to go into the hopper, concrete valve, or water box for cleaning.

SAFETY MANUAL

X. Recommended Hand Signals

The American Concrete Pumping Association (ACPA) recommends using the following hand signals as standard procedure.

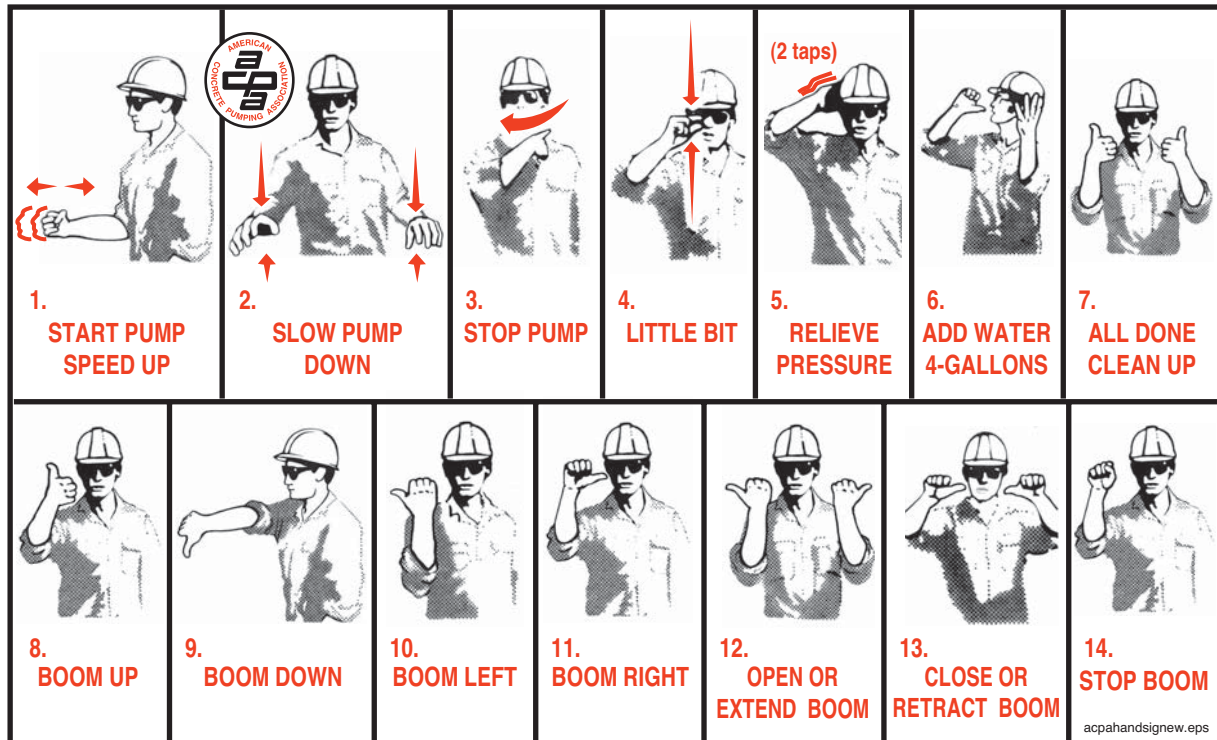

XI. Bibliography

Further information regarding concrete pumping is available from the sources listed below. Information for this book was gathered from several different sources, including the following books:

PUMPING CONCRETE AND CONCRETE PUMPS © F. W. Schwing, GmbH

CONCRETE PUMP OPERATOR'S GUIDE TO SAFETY © British Concrete Pumping Association

The MANUAL and ADVISORY SAFETY CODE of PRACTICE for CONCRETE PUMPING © British Concrete Pumping Association

Material Placement Systems - B30.27, an American National Standard © ASME.

Additional technical information and/or graphic were supplied by:

Construction Forms, Inc.

The American Concrete Pumping Association

Some cartoons were scanned from the book CONCRETE PUMP OPERATOR'S GUIDE TO SAFETY © British Concrete Pumping Association. Used by Permission.

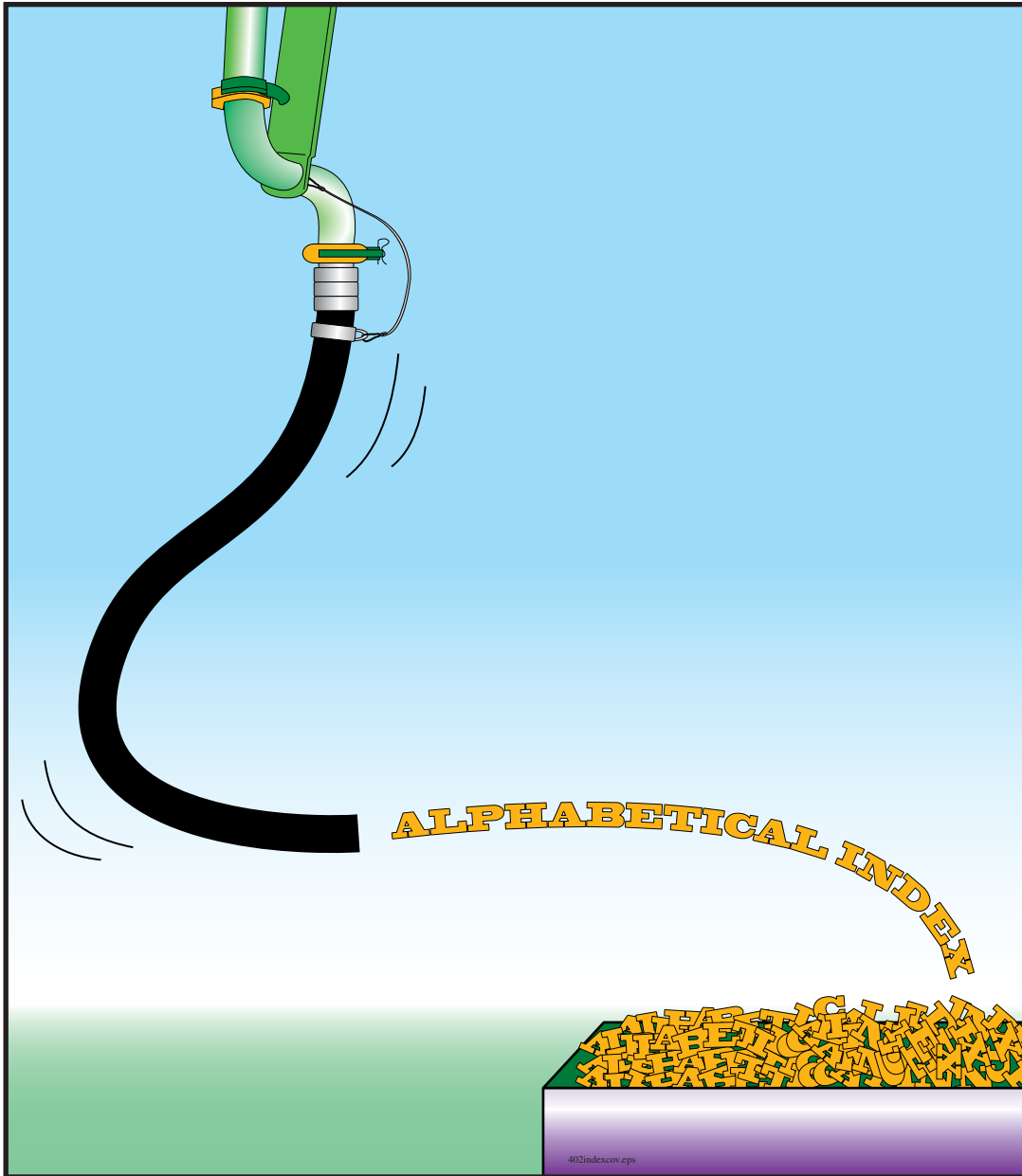

Alphabetical Index

Numerics

- 1 to 1 rule23
- 3 point rule7, 58

A

- accidents
 - causes of6, 13, 29, 46
- accumulator
 - changing max. pressure settings55
 - defined76
 - maintenance57
- ACPA recommended hand signals72, 82
- agitator, defined76
- air in delivery system40, 62, 67
- air, compressed
 - See* cleaning out, with compressed air
- alcohol, use of when operating4
- apparel
 - appropriate3, 34
 - inappropriate3
- ASME B30.27, defined76

B

- ball catcher types33
- blanking plate, defined76
- blockage
 - before opening pipeline42
 - clearing with compressed air ...42, 49, 68
 - concrete segregation41
 - defined76
 - foreign matter41, 61
 - inadequate pump40
 - inexperienced placing crew41
 - kinked hose42
 - operator error41
 - pipe deficiencies40
 - procedure to remove42
 - safe removal of41, 42, 63, 68
 - setting of concrete40
 - unpumpable mix40
- blow out head
 - See* clean out accessories, blow out head
- blowing out
 - See* cleaning out, with compressed air
- boom
 - See* placing boom

- boom, watching67
- brakes, worn6
- bulk density, defined76

C

- catcher, types of33
- caution, defined2
- certified operator, defined76
- checks
 - pre-dispatch6, 7
- children, dangers to28, 32
- clamps
 - for dissimilar ends55
 - pre-dispatch6
 - re-assembly when removing pipes69
- clean out accessories
 - blow out head5, 32, 49
 - pre-dispatch6
 - use32, 49, 52
 - catcher5, 32, 48, 49
 - pre-dispatch6
 - size5, 32
 - types33
 - use32, 49
 - compressed air
 - attachments5, 32, 46, 49
 - hose5, 32
 - go devil
 - defined77
 - size50
 - use49, 52
 - sponge ball5, 32, 49
 - defined80
 - size5, 32, 50
 - use49, 52
- cleaning out
 - hopper47
 - personal protective equipment46
 - water box47, 48
 - position of the boom for47
 - with compressed air32, 46, 49
 - blockage68
 - clean out attachments32
 - communications51
 - discharge area51
 - diversion valve52

experts	49	certified operator	76
near personnel	49, 52	concrete delivery hose	19, 76
need for 2 people	49	concrete pressure	76
outlet positioning	49	conductors	77
relieving air pressure	46	danger	2
shutoff valve	50, 52	decibel	77
through hose	46, 49, 50	drive engine	77
through short pipe	46, 49, 50	electrocution	77
trapped air	51	end hose	19, 77
vertical pipelines	32, 51, 52	expert	79
when to stop	50	foreign material	77
with water	48	go devil	77
clothes, appropriate	3	guide	77
compressed air		high voltage	77
<i>See</i> cleaning out, with compressed air		hopper grate	77
concrete		jacking the outriggers	77
bulk density maximum	40	licensed electrician	78
unpumpable mix	40	maintenance	78
concrete delivery hose, defined	19, 76	maximum pressure	78
concrete pressure, defined	76	minimum safety distance	78
concrete valve		O.S.H.A.	78
danger	44, 64	operational area	78
conductors, defined	77	personal protective equipment	78
couplings	55	point of discharge	79
comparison	74	pour	79
grooved type	74	qualified operator	34
Heavy-Duty type	74	qualified personnel	79
male/female o-ring type	74	qualified workshop personnel	79
metric type	74	rock jam	79
Victaulic type	74	safety alert symbol	2
D		separate pipeline	79
danger, defined	2	shutoff valve	79
dead man,		signal word	2
<i>See</i> thrust block		soil pressure	80
decals		sponge ball	80
safety	53	spotter	80
decibel, defined	77	sucking back	80
definition		thrust block	80
accumulator	76	towing vehicle	80
agitator	76	transport position	80
ASME B30.27	76	unauthorized	80
blanking plate	76	unintentional movement	80
blockage	76	vertical run	80
bulk density	76	warning	2
caution	2	water jet	81

- delivery system
 - air in line 40, 62, 67
 - attaching to boom 28
 - cleaning with compressed air . . . 32, 46, 49
 - cleaning with water 48
 - damaged 30
 - gaskets
 - pre-dispatch 6
 - reassembly when removing pipe 69
 - handling 64, 70
 - hose
 - inspection 5
 - kinked 42
 - pre-dispatch 6
 - inspection on the job 30
 - maximum pressure 5, 29, 55
 - minimum wall thickness . . . 5, 27, 29, 30, 54
 - pipe
 - end comparison 74
 - ends 55
 - inspection 5
 - pre-dispatch 6
 - wall thickness chart 75
 - repair of bad hose and pipe 55
 - sizing diameter 30
 - suspended sections 30
 - tapping for ball location 46
 - tip hose
 - maximum length 18
 - usable condition 27, 29
 - vertical runs 30
 - blowing out 52
 - shutoff valve 32, 52
 - thrust block 31
- dirt
 - removal 17
 - support capacity *See* soil, support capacity
- diversion valve
 - use 52
- drive engine, defined 77
- driving
 - cautions 10
 - safety devices 7, 10, 11
 - selecting route 9
 - stopping distance 11
 - windshield and mirrors 7
 - with concrete in the hopper 10
 - with PTO engaged 10
- drugs 4
- E**
 - electrical components
 - cautions 55
 - electrical wires
 - booming over 14
 - contact with an energized unit 60, 66
 - depth perception of 16, 36
 - driving dangers near 9
 - minimum distance from 14, 35, 56
 - setup dangers 15, 17
 - use of a spotter 13, 36, 60, 66
 - electrically driven units
 - disconnect box 29
 - maintenance 57
 - power supply responsibility 29
 - electrocution, defined 77
 - emergency stop 44, 59
 - end hose, defined 19, 77
 - expert, defined 79
- F**
 - falling, prevention 9, 39, 56, 62, 71
 - foreign material, defined 77
 - fuel, dangers of 38
- G**
 - gasoline and diesel fuel
 - as cleaning solvents 58
 - glossary of terms 76
 - go devil 6
 - catcher 6, 33
 - defined 77
 - size 50
 - use 52
 - grate
 - water box 43
 - guards, removal of
 - for inspection 53
 - for servicing 55
 - guide
 - defined 77

H

hand signals	27, 31, 45
ACPA recommended	72, 82
who should give	72
height	
knowledge of	9
high voltage	
defined	77
high-voltage wires, <i>See</i> electrical wires	
hopper	
danger around	44, 47, 61, 64
hopper grate, defined	77
hose	
holding correctly	69
hugging	69
inspection	5
kinked	42
maximum pressure	5
pre-dispatch	6
hoseman	69
walking	69

I

ice	
removal	17
inspection	
after structural repair	58
boom tiedown devices	53
concrete pump circuits	53
delivery system	54
placing boom	53
daily	53
keeping records	53
reporting problems	53
safety devices	53
service bulletins	53

J

jacking the outriggers, defined	77
---------------------------------	----

K

kinked hose, <i>See</i> blockages	
-----------------------------------	--

L

laborers	
alone at the pump	44, 59
assigned to the pump	44, 59

e-stop location knowledge	44, 59
handling delivery system	64, 70
notifying operator	61
personal protective equipment	59
licensed electrician, defined	78
lights	7
lockout, tagout	44, 57
loose items	
securing for travel	7, 8

M

maintenance	
changing maximum pressure settings	55
components, damaged	55
cranes and hoists, use of	56
defined	78
extending placing boom	56
for safety	54
gas or diesel as cleaning solvent	58
hidden areas	57
inspection following structural repair	58
of electrically driven units	57
of spring- or gas-loaded devices	57
oil, hot	56
operation of boom	57
removal of safety devices	55
repairs	
by qualified personnel	55
of hydraulic hose and pipe	55
of pressurized hydraulics	57
repairs, incorrect	56
safety of workers	57, 58
structural modifications, unauthorized	55
tools, correct	58
welding	55
maximum pressure, defined	78
medications, cautions	4
minimum safety distance, defined	78
N	
noise exposure chart	38
notice, usage	2
O	
O.S.H.A.	13, 29
defined	78
noise exposure chart	38

- obstructions
 - safe distance from17
 - oil
 - removal17
 - spills54
 - oilers, *See* laborers
 - 1 to 1 rule23
 - operation
 - danger to children28, 32
 - discharge point26, 31, 45
 - for servicing57
 - noise38
 - noise exposure chart38
 - personal protective equipment34
 - problems with equipment42, 53
 - security28
 - unfamiliar machines8
 - warnings5
 - operation manual5, 8, 19, 20, 53, 54, 56
 - operational area
 - defined78
 - operator
 - certification76
 - qualified, defined34
 - outrigger jacking, defined77
 - outriggers
 - close any hydraulic valves26
 - cribbing25
 - intermediate positions23
 - leveling the unit23
 - minimum distance from edge23
 - pinning6
 - soil support23
- P**
- personal problems, at work4
 - personal protective equipment
 - defined78
 - Personal Protective Equipment (P.P.E.) 3, 7, 34, 42,46, 59, 67
 - for laborers59
 - for placing crew67
 - securing for travel7
 - pipe
 - ends55
 - inspection5
 - opening when pressurized ... 42, 50, 63, 68
 - pre-dispatch6
 - wall thickness chart75
 - weld on ends74
 - pipeline, weight per foot55
 - pipewall thickness chart75
 - placing boom
 - adding extensions18
 - as hoist56
 - attaching to separate pipeline28
 - booming over wires14
 - depth perception dangers16, 36
 - discharge point26, 31, 45
 - extending for maintenance56
 - extensions18
 - inspection53
 - max. bulk density of concrete40
 - max. hanging weight18
 - max. length of endhose18
 - travel position10, 46
 - unintentional movement44
 - placing crew
 - dangerous areas68
 - dealing with blockages63, 68
 - handling hose and system68, 71
 - hazards
 - compressed air in pipeline68
 - crushing71
 - falling39, 56, 62, 71
 - hose kinking70
 - hoses70
 - pressurized pipes71
 - personal protective equipment67
 - safety rules66
 - point of discharge, defined79
 - pour, defined79
- Q**
- qualified operator, defined79
 - qualified personnel, defined79
 - qualified workshop personnel, defined79
- R**
- ready mix truck
 - backing35, 60
 - driver

- cleaning out in the hopper 61
 - what to teach them 44
 - when to begin dumping 61
- foreign material from 61
- safe approach 21
- signalling the driver 35, 60
- refueling 38
- remote control
 - plugging and unplugging 44
- rock jam, defined 79
- S**
- safety alert symbol
 - defined 2
 - usage 2
- separate pipeline, defined 79
- service bulletins 53
- setup
 - ready mix truck approach 21, 29
 - traffic 20, 29
 - unsafe 13, 29
- shutoff valve
 - defined 79
 - pressure requirements 51
 - when to open 52
- signal word, defined 2
- sleep, importance of 2
- snow
 - removal 17
- soil
 - support capacity 23
- soil pressure, defined 80
- sponge ball
 - catcher 33
 - defined 80
 - size 50
 - use 52
- spotter
 - defined 80
 - use of 13, 36, 60, 66
- sucking back, defined 80
- symbols
 - caution 2
 - danger 2
 - warning 2

- T**
- 3 point rule 7, 58
- thrust block, defined 80
- tie down straps 8
- tipping
 - danger of 10, 23, 25
- tires, bald or cracked 6
- towing
 - backing up 12
 - knowledge of the laws 11
 - loss of control 11
 - stopping distance 11
 - trailer mounted pumps 11, 12
 - truck mounted pumps 11
- towing vehicle, defined 80
- transport position, defined 80
- triangle 2
- U**
- ultrasonic thickness tester 27, 54
- unauthorized, defined 80
- unintentional movement, defined 80
- V**
- vertical pipeline
 - See* delivery system, vertical runs
- vertical run, defined 80
- Victaulic, *See* delivery system, pipe ends, grooved
- W**
- walking with end hose
 - backwards 69
 - correctly 69
- warning, defined 2
- watching the boom 67
- water box
 - checking while pumping 43
 - danger 44, 47, 48, 64
- water jet, defined 81
- weather conditions
 - considerations 6
 - lightning 26
 - maximum wind speed 26
- weight
 - knowledge of 9
 - knowledge responsibility 9

- weight per foot, pipeline55
- welding
 - current arcing damage55
 - minimum certification rating55
 - on electrical components55
- wheel chocks17
- workers
 - alone at the pump 44, 59
 - assigned to the pump 44, 59
 - e-stop location knowledge 44, 59

Information contained in this Safety Manual is not intended to supercede the manufacturer's recommendations or company policies.



SCHWING
AMERICA INC.

5900 Centerville Road
White Bear, MN 55127
ph: 651 429 0999
fax: 651 429 3464
www.schwing.com