

05. 2004

SCHWING ñ Control system " VECTOR "

SERVICE MANUAL

valid from software version V 1.10 onwards



PART 1: OPERATION

PART 2: TEACH MODE

Published by: SCHWING GmbH
Dept.: **VVW**
Postfach : 20 03 62
D - 44647 Herne
Id. no.: 10207417
15.04.04 13:06

START SCREEN:

The screenshot displays the start screen with the following elements:

- PTO Speed:** A semi-circular gauge with a needle pointing to 1.35 on a scale from 0 to 3, labeled "x1000". Below the gauge, a digital display shows "PTO 1350 rpm".
- Hydraulic oil temperature:** A thermometer icon showing a reading of "62 °C".
- Oil cooler "On":** A fan icon with a checkmark, indicating the oil cooler is active.
- Control status:** A vertical column of icons: "OK", a "Start" button, a switch icon labeled "OFF?", an "E-stop" button, and a question mark.
- Modes of operation:** A vertical column of icons: a remote mode icon, a local mode icon, a ram change mode icon, and a "Teach mode" button.
- Menu bar:** At the bottom, it shows a left arrow, a down arrow, and the text "Menu: [ENTER] = ON".

Control status

- OK System is running
- Start Start up control unit
- OFF? Control switches not in neutral position
- STOP! E-stop activated
- ? Entry expected

Modes of operation

- Remote mode
- Local mode
- Ram change mode
- Teach mode

Menu bar for further screens

Concrete pump delivery rate

SCHWING control system 'VECTOR'

OPERATION

The present instructions are intended to serve as a 'memory aid'. They do not refer to any particular type of machine and do not relieve the user of familiarizing himself with the operating manual of the machine in question.

CONTENTS

- | | |
|------------------------------------|-----------------------------------------|
| 1. COMMISSIONING | 3.1 CONTROL CABINET |
| 1.1 LOCAL CONTROL | 3.1.1 DISPLAY |
| 1.2 REMOTE CONTROL | 3.1.2 MENU CONTROL |
| 1.3 RAM CHANGE MODE | 3.2 LOCAL CONTROL |
| 2.1 ENGINE START / STOP | 3.3 REMOTE CONTROL |
| 2.2 EMERGENCY STOP | 4. MENU OVERVIEW - MAIN MENU / SUBMENUS |
| 2.3 BYPASS MODE | 5. MENU OPERATION - EXAMPLE |
| 3. CONTROL AND MONITORING ELEMENTS | 6. DIAGNOSTIC SYSTEM FAULT HANDLING |
| | 6.1 SUMMARY OF MESSAGES |

1. COMMISSIONING

The electrical machine control system can only be activated if the drive configuration has been properly selected:

- Switch on the ignition of the vehicle.
- Shift the travel gearbox to neutral position (idling)*.
- Apply the parking brake.
- Switch on the P.T.O*.

* For vehicles without P.T.O. see machine operating instructions.

- Switch on the machine control in the driver's cab.

The system is being initialized as indicated by the bar graph on the display.

The starting screen is displayed after the initialization (Fig. 1).

- Select the desired mode of operation with switch 3 (Fig. 2):



local control



remote control



pumping piston replacement

The mode selected is indicated in display section 5 (Fig. 1).

Now, the following functions can be activated:

- signal horn on
- engine off
- speed reduction

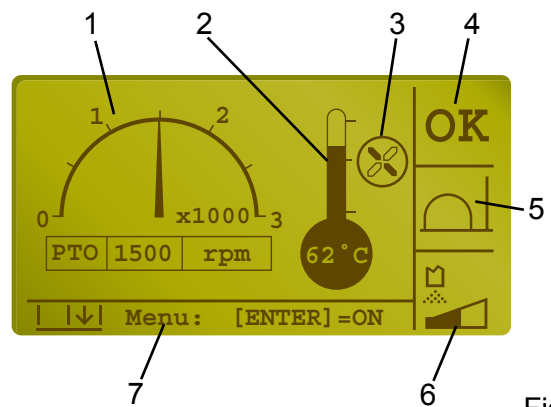

Fig. 1

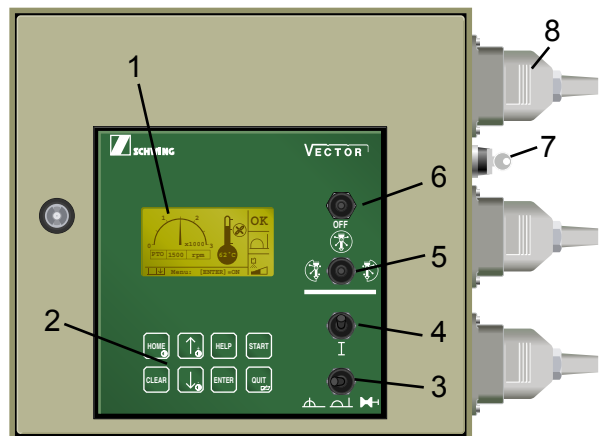
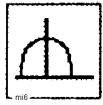

Fig. 2

1.1 LOCAL CONTROL



This symbol is displayed in section 5 (Fig. 1) of the screen.



This symbol flashes in section 4 when a E-stop has been pressed:

Unlock **all** emergency stop stations



This symbol flashes in section 4 when one a of the switches on the local control panel is on (Fig. 2):

Set all switches to neutral.



This symbol flashes in section 4 when the system is ready for start-up.



Start the control with pushbutton 4 (Fig. 3).



Starting is confirmed by a brief acoustic signal and the symbol on the left is displayed in section 4 (Fig. 1).

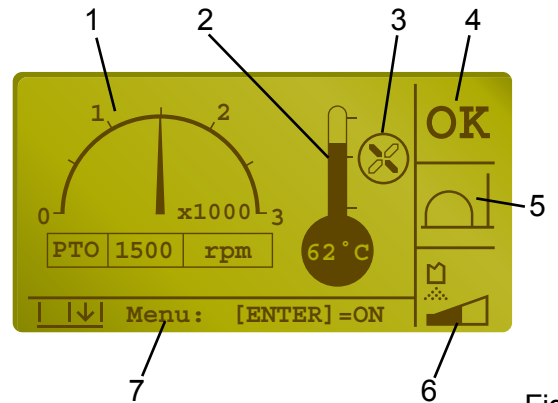

Fig. 1

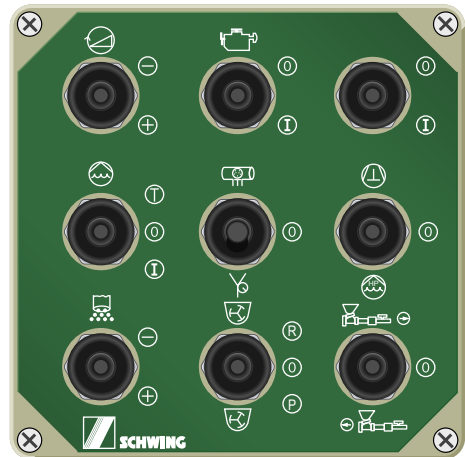

Fig. 2

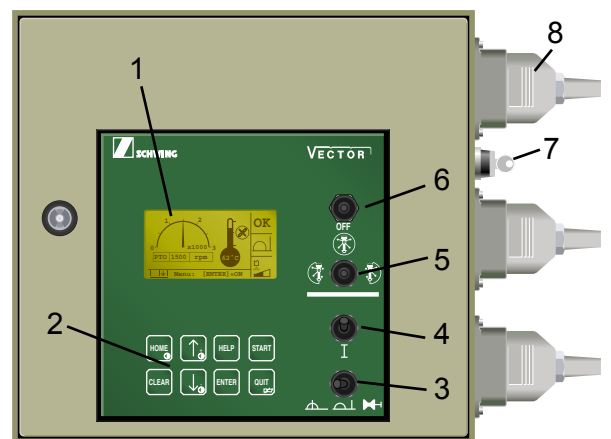
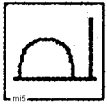

Fig. 3

1.2 REMOTE CONTROL



This symbol is displayed in section 5 of the screen (Fig. 1).



This symbol flashes in section 4 when an emergency stop button **on the machine or on the remote-control box** (Figs. 2) has been pressed:

The symbol flashes also when the remote-control box is off:

Unlock all emergency stop buttons or switch on the remote-control box.



This symbol flashes in section 4 when a switch on the remote-control box is on.

Set all switches to neutral.



This symbol flashes in section 4 when the system is ready for start-up:



Start up the control with this push-button on the remote-control box.



Starting is confirmed by a brief acoustic signal and the symbol on the left is displayed in section 4 (Fig. 1).

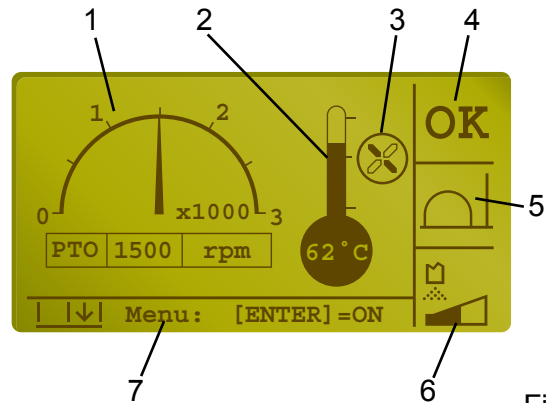

Fig. 1



Fig. 2

1.3 RAM CHANGE MODE



This symbol is displayed in section 5 of the screen (Fig. 1).



This symbol flashes in section 4 when a E-stop station on the machine has been pressed:

Unlock **all** emergency shut-off buttons.



This symbol flashes in section 4 when the system is ready for start-up.

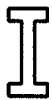

Start up the control with pushbutton 4 (Fig. 2).



Starting is confirmed by a brief acoustic signal and the symbol on the left is displayed in section 4 (Fig. 1).

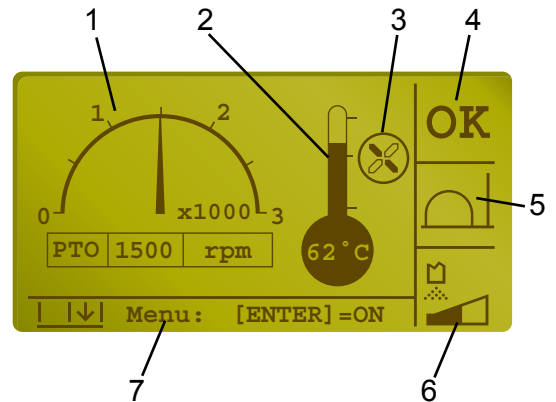

Fig. 1

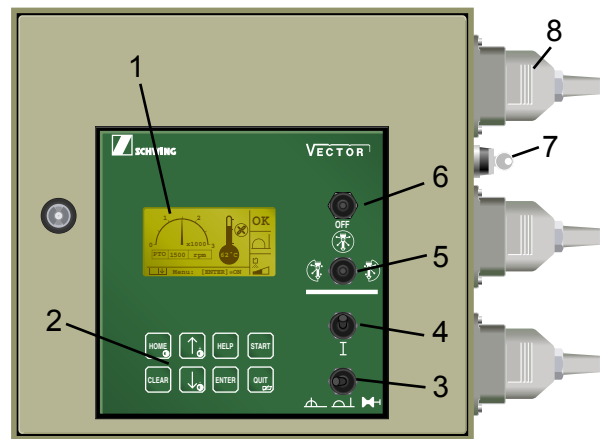

Fig. 2

The activation of the 'RAM CHANGE MODE' automatically reduces the speed of the engine.

The concrete pump and the diesel engine can now be controlled with the switches on the special control box (Fig. 3).

See machine operating instructions, chapter 4.43: 'RAM CHANGE MODE'.

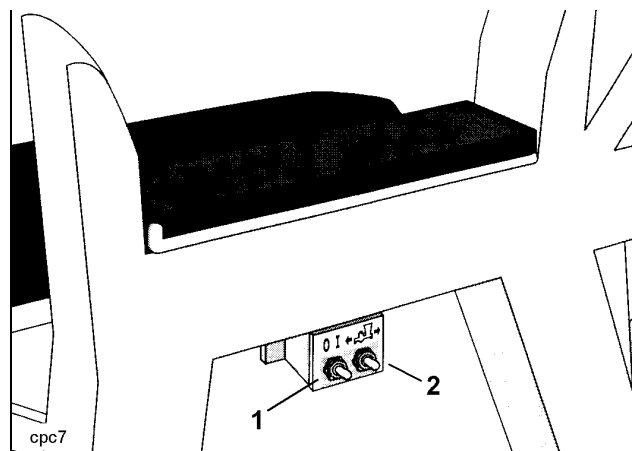

Fig. 3

2.1 ENGINE START / STOP

To prevent unintended starting of a machine function, the engine can only be started when all switches (controlling hydraulic functions) are in their neutral (0) position.

Shutting off the engine when a function is active is possible, but should be avoided.

If there is no emergency, always proceed as follows.

- deactivate the function(s), then
- reduce the engine rpm to idle
- shut off the engine.

2.2 EMERGENCY STOP

Do not use the emergency stop switches as an on/off switch, it is for emergencies only.

In normal operating conditions always stop the machine functions and the engine with the controls provided for this purpose.

2.3 BYPASS MODE

The dump valves of the machine are open without current. This means:

These valves will open when the power supply has been interrupted (E-stop is active).

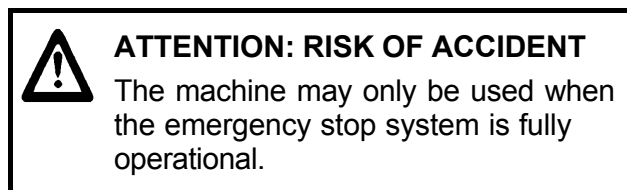

If - in certain emergency situations (machine loaded with concrete) - the machine cannot be repaired immediately, the power supply to the dump valves can be reactivated manually:

- To do so, insert the key into key-switch 7 (Fig. 1) and turn it to the locked position.

In this position, the key cannot be withdrawn.

- Control the machine movements with the manual levers of the control valves.
- Clean the machine and bring to it transport position.
- Stop working on the job and have the emergency shut-off system be repaired immediately.

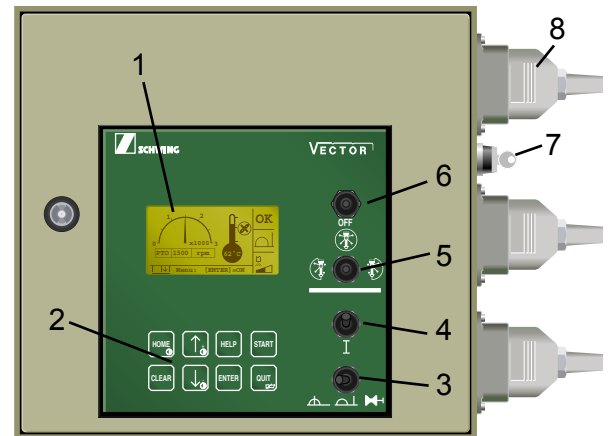
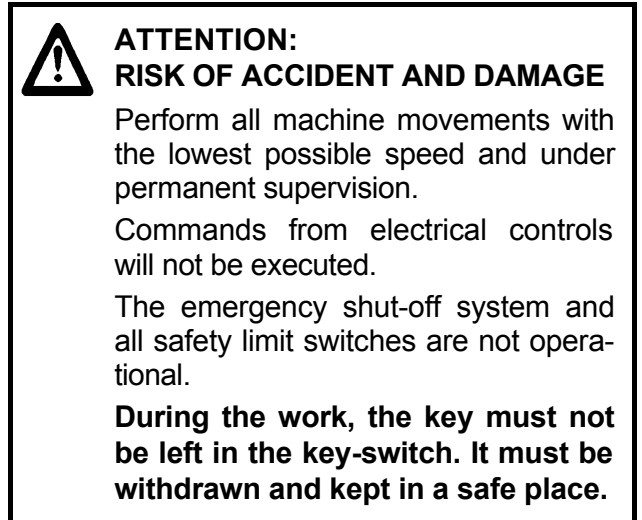

3. CONTROL AND MONITORING ELEMENTS

3.1 CONTROL CABINET (Fig. 1)

- 1 - Display
- 2 - Key: menu control
- 3 - Operating mode selector:
 - local control
 - remote control
 - ram change mode
- 4 - Momentary-contact switch: control on
- 5 - Switch:
 - Select EASy working range *
- 6 - Switch: EASy* off
- 7 - Key-switch:
 - Emergency stop bypass
- 8 - Connector: radio or cable remote control

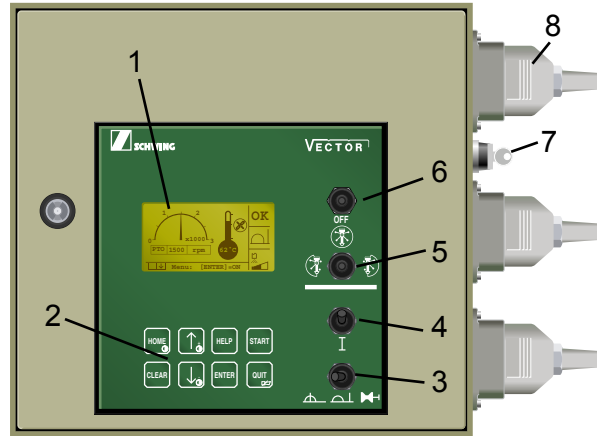

Fig. 1

* Optional equipment: One-Side Outrigger System (EASy), see separate operating instructions

3.1.1 DISPLAY

On start-up, the following data are displayed on screen (Fig. 2):

- 1 - P.T.O. speed
- 2 - Hydraulic oil temperature
- 3 - Oil cooler "on"
- 4 - Control status
- 5 - Selected mode of operation
- 6 - Concrete pump delivery rate
- 7 - Menu options

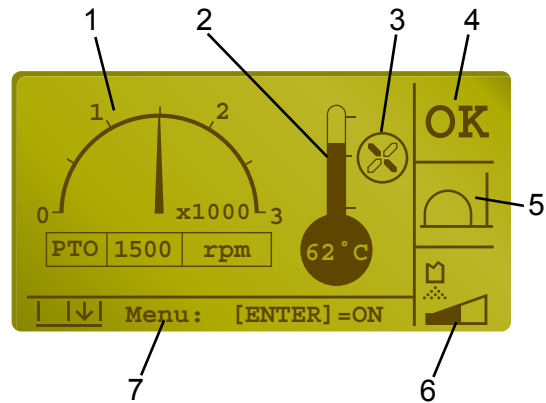



Fig. 2

Important note:

After pressing the  key on the menu control panel, further operational data can be displayed:

- concrete pump hydraulic oil pressure
- hydraulic oil reservoir level indication (optional equipment)
- engine load factor (optional equipment independent of vehicle)

Control status indications:

Section 4 (Fig. 1) of the screen displays the following conditions:



Control system is running.



Control off, start up.



Starting not possible: switches not in neutral position.



Starting not possible: emergency stop activated

Operating mode display:

Section 5 (Fig. 1) of the screen displays the following modes of operation:

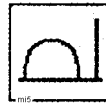

Remote-control (radio or cable)

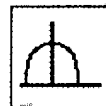

Local control



Pumping piston replacement

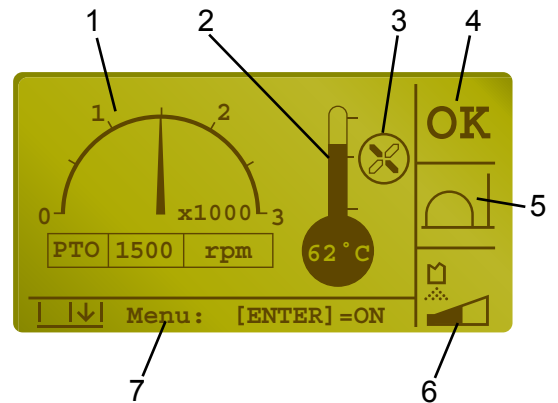

Fig. 1

3.1.2 MENU CONTROL

Basic functions of the keys (2) in Fig. 1:

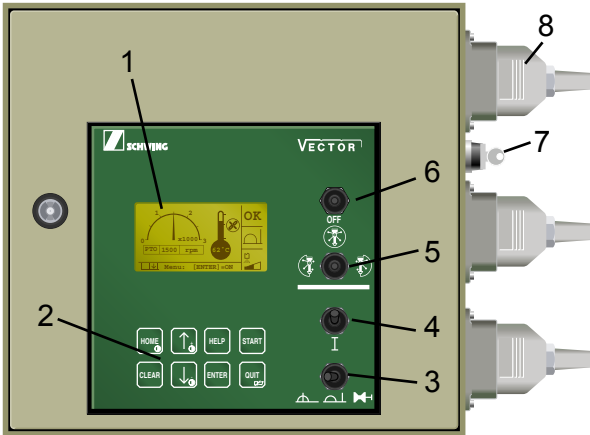

Fig. 1

When a key pressed, the corresponding function is identified by a symbol in the upper left corner of the display.



One step back in menu.



Select indicated menu item or activate changes



Confirmation and reset of diagnostic messages.

Fast selection / abbreviated function keys (shortcuts):

Press the following keys **at the same** :



Full return to start screen



and

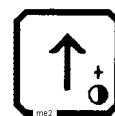

or

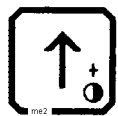
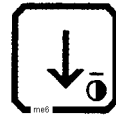

Up one item in the menu selection list.

to set the contrast of the LCD display manually.

During setting, the contrast is indicated on display between 0 and 99 %.



Down one item in the menu selection list.



Supplementary information for certain screens of the diagnostic function. **Presently not implemented.**



and



to go to the manual language selection for all displays.



Execution of certain actions, e.g. re-setting of the concrete pump's delivery rate counter.

3.2 LOCAL CONTROL

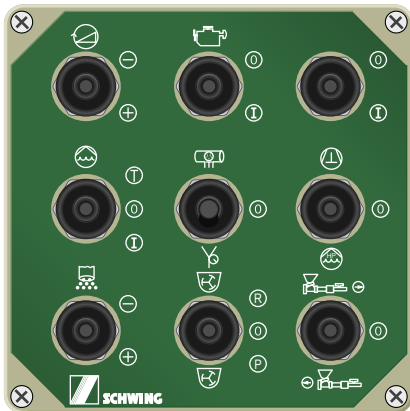

RPM engine
(+) = up
(-) = down



Vehicle engine
(I) = start
(0) = stop



Work light



Water pump
(I) = locked (continuous)
(T) = momentary (special control)



Vibrator



Ball injection system



High-pressure water pump



Compressor



Concrete pump delivery rate
(+) = increase
(-) = reduce

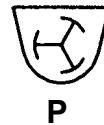

Agitator
(P) = forwards (pumping)

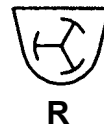

Agitator
(R) = reverse (suction)



Concrete pump forwards (pumping)

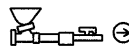

Concrete pump reverse (suction)

3.3 REMOTE CONTROL



RPM engine
 (+) = up
 (-) = down



Vehicle engine
 (I) = on (starting)
 (0) = off (stopping)



Control on
 Diagnostic horn signal confirm
 (shut-off)



Vehicle signal horn on



End hose shutoff valve.



Ball injection system.



Concrete pump delivery rate
 (+) = increase
 (-) = reduce



Vibrator in automatic mode on



Water pump



Agitator in:
 (↗) = forward
 (↖) = reverse



Compressor



Concrete pump
 forwards (pumping)

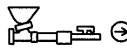

Concrete pump
 reverse (suction)



boom speed slow
 (placing operations)

(0)

boom functions off



boom speed fast
 (set-up and take-down)

Radio remote control only:



LED:
 charge condition of transmitter battery



LED:
 transmitter state of operation:

continuously on = transmitter ready

flashing = transmitting control signals

4.1 MENU OVERVIEW - MAIN MENU

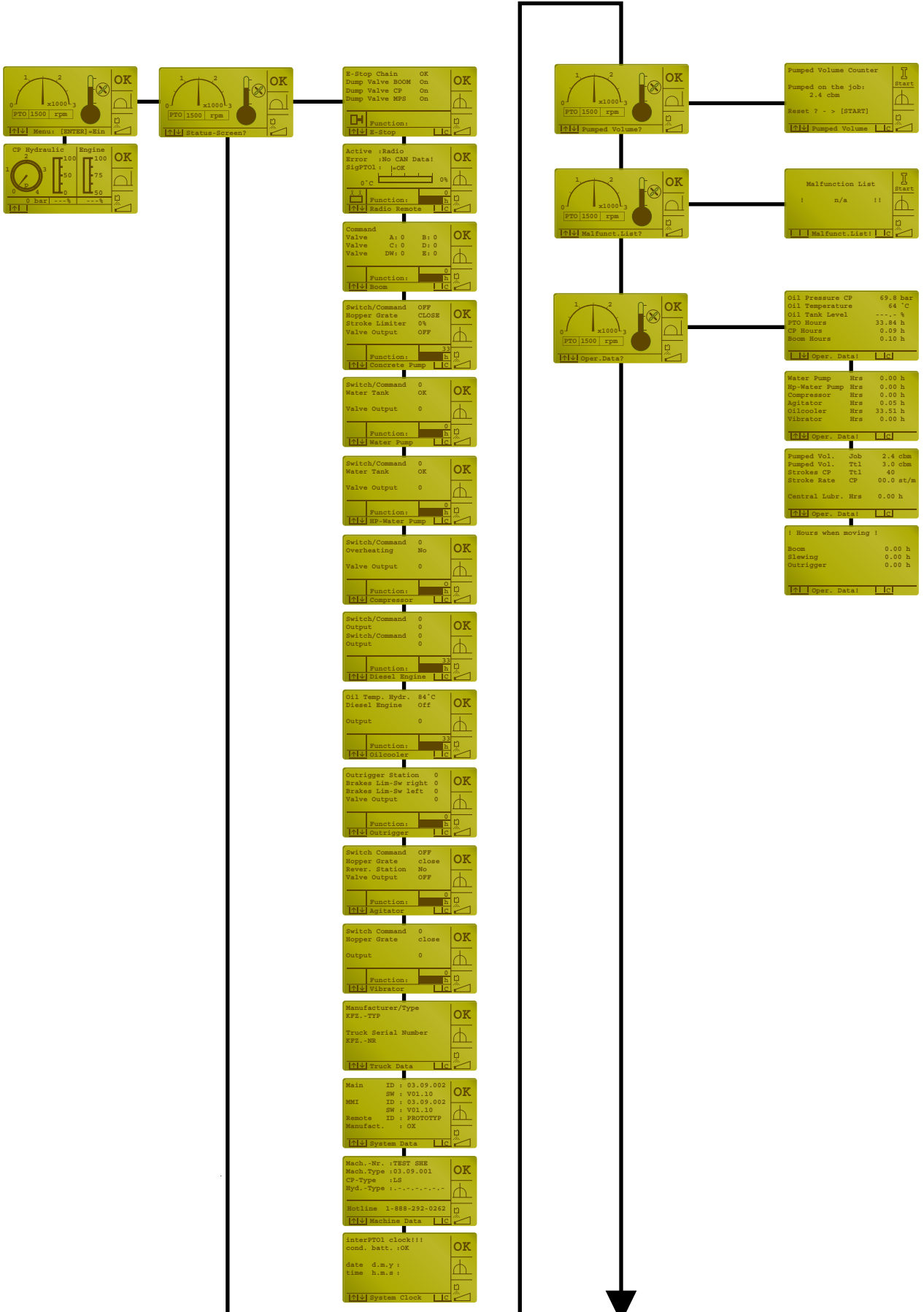

PART 1

- 13b -

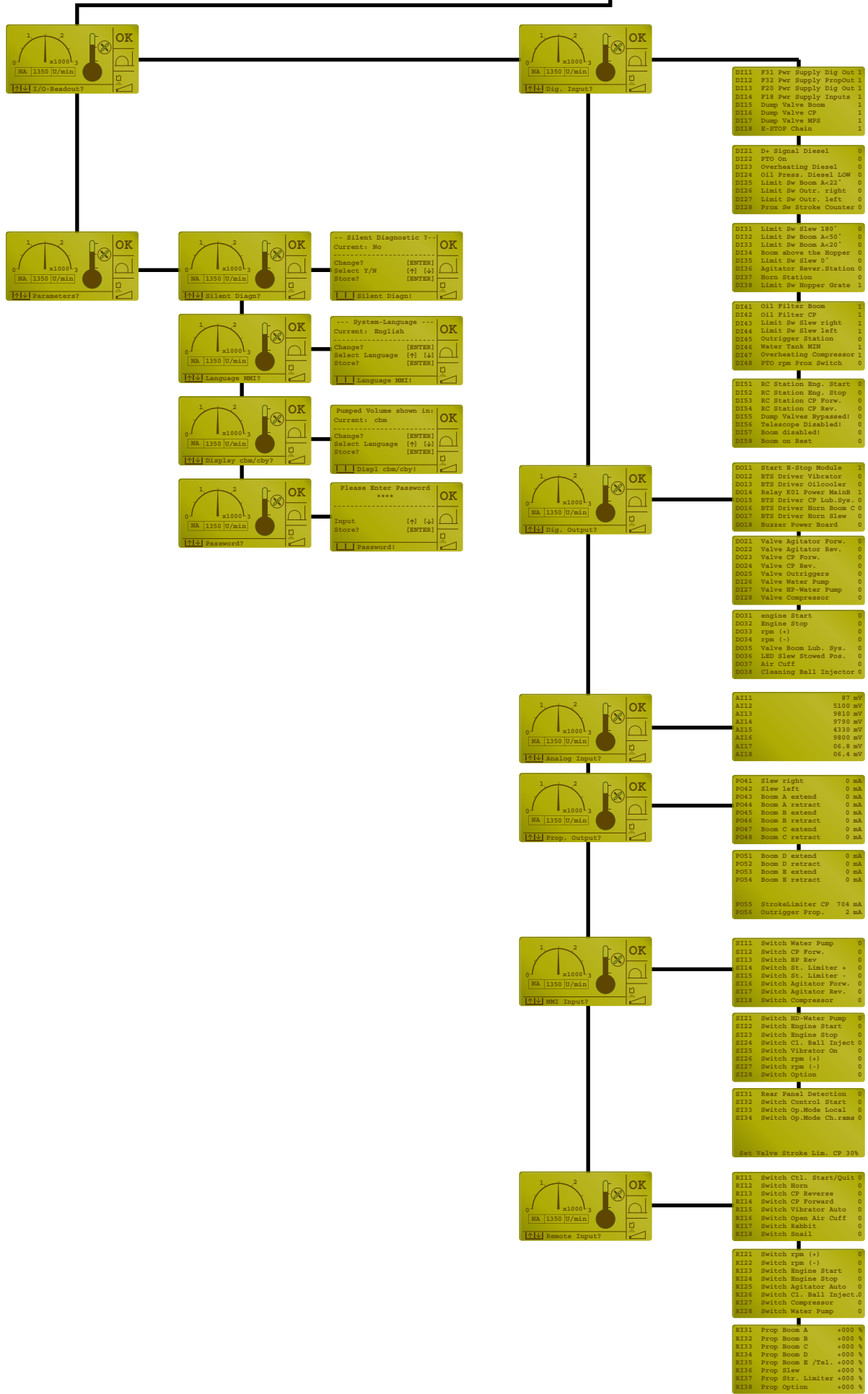







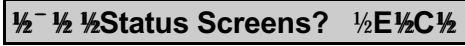

4.2 MENU OVERVIEW - SUBMENUS

Status Screen?	Pumped Volume?	Malf. list?	Oper. data?	I/O readout?	Parameters?
<ul style="list-style-type: none"> • E-stop • remote control • Boom • concrete pump • water pump • high-pressure water pump • compressor • diesel engine • oil cooler • outrigger • agitator • vibrator • machine data • truck data • system data • system clock 	<ul style="list-style-type: none"> • pumped volume counter 	<ul style="list-style-type: none"> • Malfunction list 	<ul style="list-style-type: none"> • oil parameters • operating hours: <ul style="list-style-type: none"> - P.T.O - CP - boom • operating hours: <ul style="list-style-type: none"> - other • CP delivery rate: <ul style="list-style-type: none"> - day / total - strokes • moving hours: <ul style="list-style-type: none"> - boom - slew drive - stabilizers 	<ul style="list-style-type: none"> • digital input? <ul style="list-style-type: none"> - DI11-DI58 • digital output <ul style="list-style-type: none"> - DO11-DO38 • analog input? <ul style="list-style-type: none"> - AI11-AI22 • prop output? <ul style="list-style-type: none"> - PO41-PO56 • MMI input? <ul style="list-style-type: none"> - SI11-SI34 • remote control? <ul style="list-style-type: none"> - RI11-RI38 	<ul style="list-style-type: none"> • silent diagnostic • language MMI? • display <ul style="list-style-type: none"> - cbm / cby? • password: <ul style="list-style-type: none"> - limit SR CP - Efficiency CP?

5. MENU OPERATION – EXAMPLE:

RESETTING THE CONCRETE PUMP DAILY DELIVERY RATE

ACTION:		RESULT:
Press:		menu line in opening screen: 
Press:		next menu line: 
Press:		next menu line: 
Press:		display of daily pumping rate, e.g.: 18,0 m ³
Press:		daily pumping rate reset to 0.0 m ³
Press:		return to opening screen

**6. DIAGNOSTIC SYSTEM /
"FAULT HANDLING"**

(from software version V 1.10 onwards)

The integrated diagnosis system informs the operator about certain operating states, displays faults and indicates the possible causes.

The corresponding messages are displayed on the screen of the control unit 1 (Fig. 1).

The information displayed is always composed of a code and the corresponding message.



CODE

The four-digit code is composed as follows:

X xx X

- X.....: Origin of message
- xx.....: Number of message
- X : Type of message

Example:

P01M

- P.....: Pump (concrete pump)
- 01.....: Number of message
- M.....: Message

The following message origins are available (1st column):

- B = Boom (placing boom control)
- D = Diesel engine (truck diesel engine)
- M = Machine (general machine control)
- O = Optional (Optional control functions)
- P = Pump (concrete pump)
- R = Remote (remote control system)
- S = System

The following types of message are existing:

- M = Message
- L = Low-level fault (minor fault)
- H = High-level fault (severe fault)

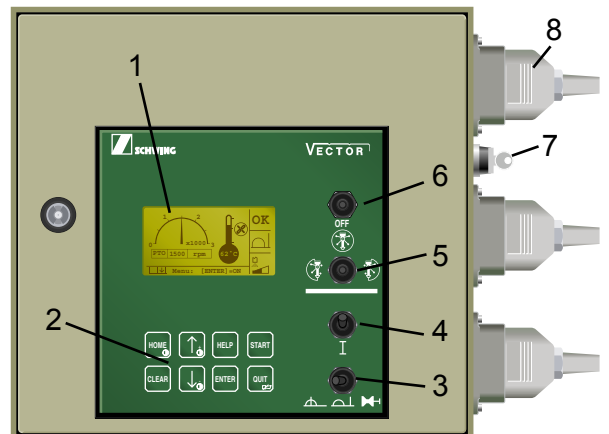

Fig. 1

DISPLAY LANGUAGE

Texts can be displayed in three languages.

The language of text displays can be selected in the "Parameter?" menu under "Language MMI?".

If "International" is selected, the messages are displayed without text by means of symbols.

Chapter 6.1 contains a complete list of the text messages together with the international symbols.

The messages are sorted by their code in alphabetical order.

Example 1: Text display

Message: Pressure Limiter
Concrete Pump
Activated !

Code: **P01M**

Example 2: International display

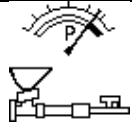
Message: 

Code: **P01M**

Important:
Since the international display makes multiple use of the various symbols, it is absolutely essential to consult chapter 6.1 for a clear identification of the message.



Text messages as well as international symbols may include additional information for service personnel.

Example 1: Text display

Disconnected / Overload
Solenoid Slewing Right
- PO41 !

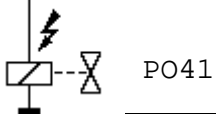

Example 2: International display

PO41 designates, for instance:

Proportional Output 41

The following additional information is possible:

PO = Proportional Output

DO = Digital Output

K = Relay

F = Fuse

ACKNOWLEDGING MESSAGES

Messages (M) are not a faults!

They are announced only visually on display and can be acknowledged with the "CLEAR" key.



ACKNOWLEDGING FAULTS

Low Level faults are announced visually on the screen and acoustically by an intermittent tone.

These faults can be acknowledged via remote control or directly on the control cabinet.

High Level faults are announced visually on display and acoustically by an intermittent tone.

They can only be acknowledged on the control cabinet.

In both cases, the acoustic signal can be shut off via remote control.

For a detailed description see below

FAULT DEFINITION

In the event of a "low level fault", the job can still be finished even if only with certain restrictions.

"High level faults" will cause direct damage to the machine. Control system will go to E-stop mode. Operator must decide if the fault displayed will influence operational safety.



ATTENTION: RISK OF ACCIDENT AND DAMAGE

SCHWING assumes no liability for damage caused by faults not rectified.

When a "low level fault" is reported, this does **not** mean that it can be completely ignored, but only that the job can be finished, probably with certain restrictions.

The operator is responsible that a fault once signalled is rectified immediately in order to prevent potential damage to the machine.

If a fault message is cancelled without the fault having been rectified, the fault message will **not** be repeated.

SILENT DIAGNOSTIC

In the "Parameter?" menu under "Silent diag?" the operator can select whether a fault is signalled in the "REMOTE" mode of operation by the horn or the buzzer in the control cabinet.

MENU OVERVIEW – Silent diagnostic

Display menu line / Key:

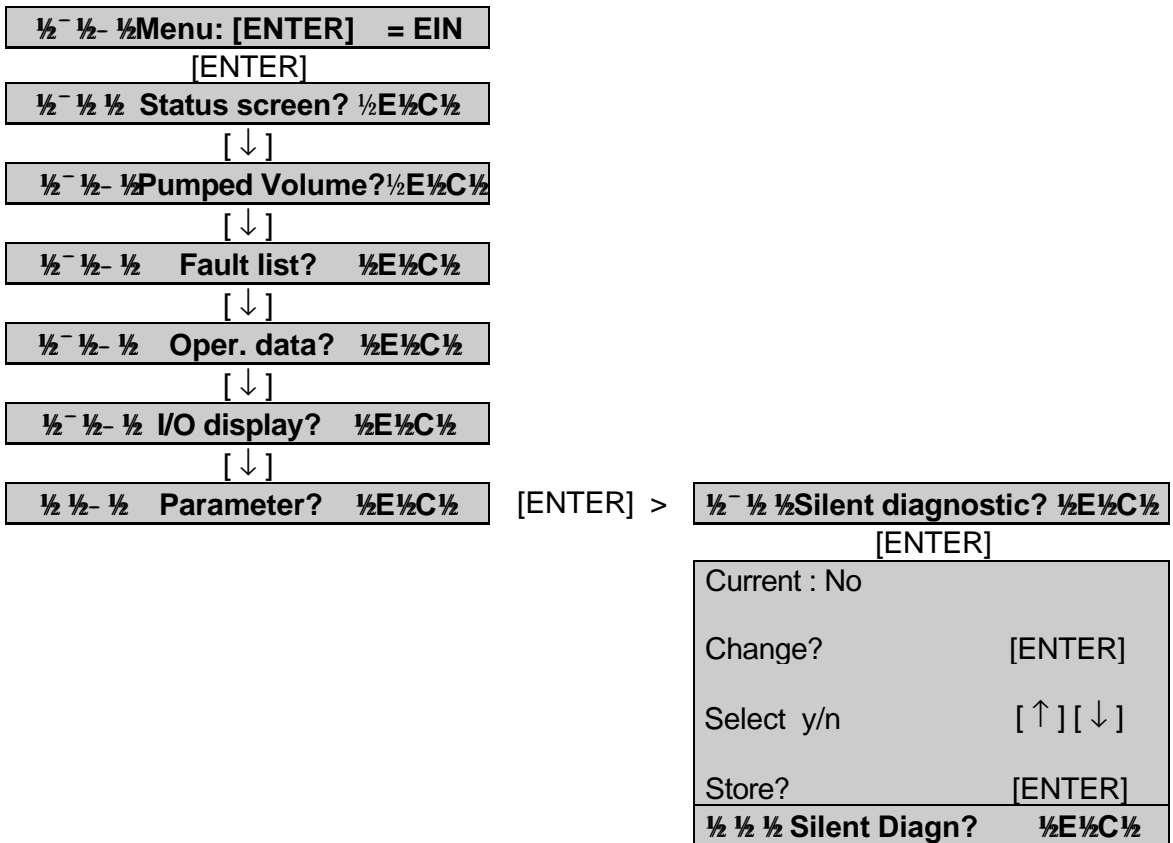

Silent diagnostic: **Yes**

- message displayed on the screen
- acoustic signal from buzzer

Silent diagnostic: **No**

- message displayed on the screen
- acoustic signal from horn

REPORTING AND ACKNOWLEDGING OF FAULTS

Faults are acknowledged dependent on the selected mode of operation (LOCAL or REMOTE) and on the severity of the fault:

1. Mode of operation	: LOCAL
Silent diagnostic	: Yes or No
Minor fault	

In the **LOCAL** mode of operation, minor faults are reported and acknowledged in the same way and irrespective of whether **Yes** or **No** has been selected for the silent diagnosis:

The fault is displayed on the screen and announced by the buzzer in the control cabinet.

- Depress the "QUIT" key on the control panel (Fig. 1) **once**.



The buzzer stops sounding.

The message continues to be displayed and can be read in no hurry.

- Depress "QUIT" once more.



The fault message is definitely acknowledged.

The message is deleted from the display and logged in the faults list.

2. Mode of operation	: LOCAL
Silent diagnostic	: Yes or No
Severe fault	

In the **LOCAL** mode of operation, severe faults are reported and acknowledged as described under **1**.

In addition, the control system is switched off. Optional shutdown of the engine is also possible.

A severe fault can only be acknowledged from **LOCAL**.

⚠ ATTENTION: RISK OF ACCIDENT AND DAMAGE

After shut-off by a severe fault, the control system and, if applicable, also the drive engine must be restarted.

ñ It is absolutely vital to have a severe fault rectified before re-starting. There is otherwise the risk of irreparable damage to the machine.

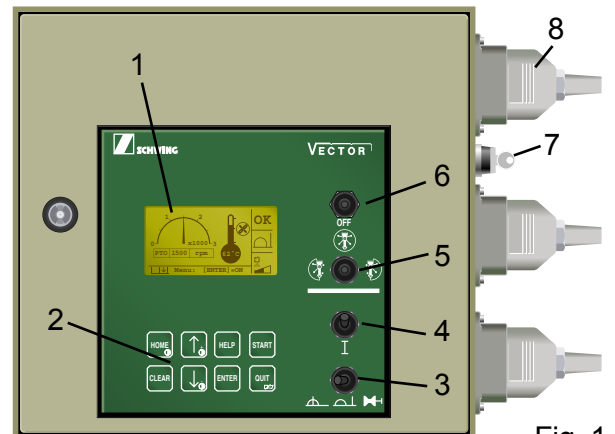

Fig. 1

3. Mode of operation	: LOCAL
Silent diagnostic	: No
Low level fault	

The fault is displayed on the screen and announced by a horn signal.

- Activate "QUIT" on the remote control box (Fig. 1) **once**.



The horns stop sounding.

The message is deleted from the display.

Important:

Low level faults acknowledged immediately with the "QUIT" key on the control cabinet in the REMOTE mode are not reported again when switching over from LOCAL to REMOTE.



- After switching the mode of operation from **REMOTE** to **LOCAL**, the fault is displayed on the screen and announced by the buzzer in the control cabinet.

- Depress the "QUIT" key on the control cabinet (Fig. 2) **once**.



The buzzer stops sounding.

The message continues to be displayed and can be read in no hurry.



Fig. 1

- Depress "QUIT" once more.



The fault message is definitely acknowledged.

The message is deleted from the display and logged in the faults list.

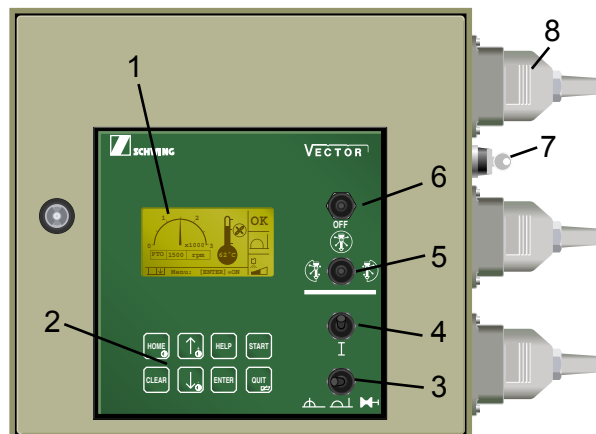



Fig. 2

4. Mode of operation	: REMOTE
Quiet diagnosis	: Yes
Low level	

The fault is displayed on the screen and announced by the buzzer in the control cabinet.

- Activate "QUIT" on the remote control box (Fig. 1) **once**. 

The buzzer stops sounding (if not switched off manually, the buzzer will be stopped automatically after 60 seconds).

The message is deleted from the display.

- After switching the mode of operation from **REMOTE** to **LOCAL**, the fault is displayed on the screen and announced by the buzzer in the control cabinet.

- Depress the "QUIT" key on the control cabinet (Fig. 2) **once**. 

The buzzer stops sounding.

The message continues to be displayed and can be read in no hurry.

- Depress the "QUIT" key on the control cabinet (Fig. 2) **once** more. 

The fault message is definitely acknowledged.

The message is deleted from the display and logged in the faults list.

Important:

Low level faults acknowledged immediately with the "QUIT" key on the control cabinet in the REMOTE mode are not reported again when switching over from LOCAL to REMOTE.





Fig. 1

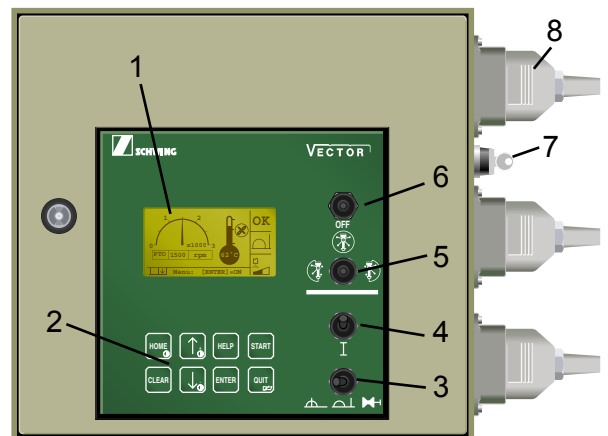

Fig. 2

5. Mode of operation	: REMOTE
Quiet diagnosis	: No
High level	

The fault is displayed on the screen and announced by the horns.

In addition, the control system is switched off. Optional shutdown of the engine is also possible.

- Activate "QUIT" on the remote control box (Fig. 1) **once**.



The horns stop sounding.

The message continues to be displayed and can be read in no hurry.

- Depress the "QUIT" key on the control cabinet (Fig. 2).



The fault message is definitely acknowledged.

The message is deleted from the display and logged in the faults list..

Important:
High level faults can only be acknowledged with the "QUIT" key on the control cabinet irrespective of the selected mode LOCAL or REMOTE.



Fig. 1

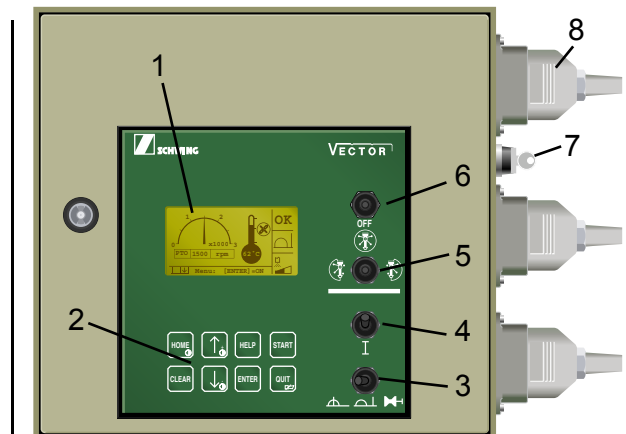



Fig. 2

ATTENTION:
RISK OF ACCIDENT AND DAMAGE
After shut-off by a high level fault, the control system and, if applicable, also the drive engine must be restarted.
ñ **It is absolutely vital to have a severe fault rectified before re-starting. There is otherwise the risk of irreparable damage to the machine.**

6. Mode of operation	: REMOTE
Silent diagnostic	: Yes
High level fault	

The fault is displayed on the screen and announced by the buzzer in the control cabinet

In addition, the control system is switched off. Optional shutdown of the engine is also possible.

- Activate "QUIT" on the remote control box (Fig. 1) **once**. 

The buzzer stops sounding (if not switched off manually, the buzzer will be stopped automatically after 60 seconds).

The message continues to be displayed and can be read in no hurry.

- Depress the "QUIT" key on the control cabinet (Fig. 2). 

The fault message is definitely acknowledged.

The message is deleted from the display and logged in the faults list.



Important:
High level faults can only be acknowledged with the "QUIT" key on the control cabinet irrespective of the selected mode LOCAL or REMOTE. 



Fig. 1

 **ATTENTION:
RISK OF ACCIDENT AND DAMAGE**
After shut-off by a high level fault, the control system and, if applicable, also the drive engine must be restarted.
ñ It is absolutely vital to have a severe fault rectified before re-starting. There is otherwise the risk of irreparable damage to the machine.

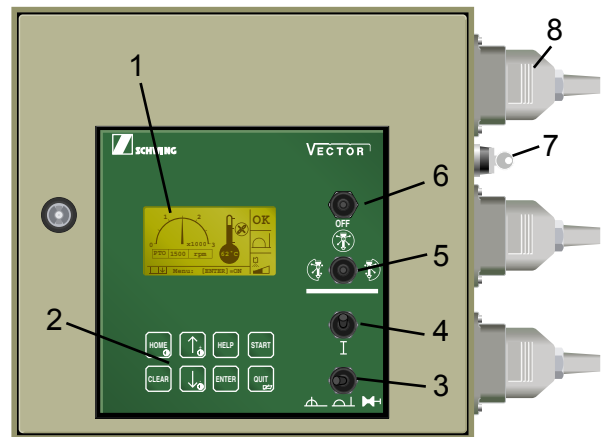
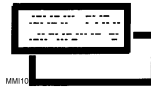

Fig. 2

ACKNOWLEDGING OF SEVERAL FAULTS

If several messages are existing, a symbol appears in the lower right-hand corner of the display:



- Acknowledge the first message as usual.

The next message appears and the buzzer sounds.



- Acknowledge this and also any following message until no message is displayed anymore.

6.1 SUMMARY OF MESSAGES

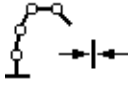
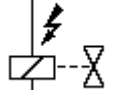
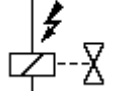
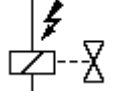
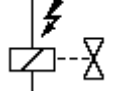
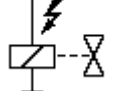
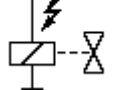

Code	international version (symbolic)	plain text messages
------	----------------------------------	---------------------

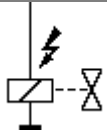
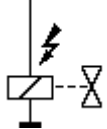
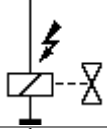
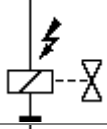
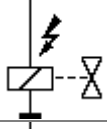
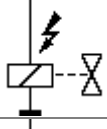
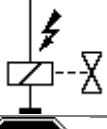





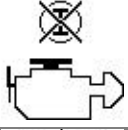
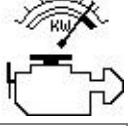





B = Boom





B01M		Limitation Slewing Gear Activated !
B02M		BOOM Limitation Activated !
B04L		Disconnected / Overload E-Stop Solenoid BOOM !
B05L		PO41 Disconnected / Overload Solenoid Slewing Right - PO41 !
B06L		PO42 Disconnected / Overload Solenoid Slewing Left - PO42 !
B07L		PO43 Disconnected / Overload Solenoid BOOM A extend - PO43 !
B08L		PO44 Disconnected / Overload Solenoid BOOM A retract - PO44 !
B09L		PO45 Disconnected / Overload Solenoid BOOM B extend - PO45 !

B10L		PO46	Disconnected / Overload Solenoid BOOM B retract - PO46 !
B11L		PO47	Disconnected / Overload Solenoid BOOM C extend - PO47 !
B12L		PO48	Disconnected / Overload Solenoid BOOM C retract - PO48 !
B13L		PO51	Disconnected / Overload Solenoid BOOM D extend - PO51 !
B14L		PO52	Disconnected / Overload Solenoid BOOM D retract - PO52 !
B15L		PO53	Disconnected / Overload Solenoid BOOM E extend - PO53 !
B16L		PO54	Disconnected / Overload Solenoid BOOM E retract - PO54 !
B17H			! Machine Safety Stop ! BOOM Control Fault !







D = Diesel Engine







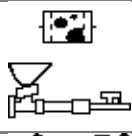
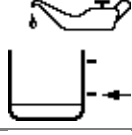



D01M		Some Hydraulic Functions Not In Neutral! Diesel Start Disabled!
D02M		Power Limitation Diesel Engine Activated !
D03L		PTO is not working or Prox-Switch PTO-RPM Fault !



D04L			PTO RPM-Limit exceeded !
D05L			Indicator-Switch PTO = ON/OFF Fault !
D06L			Indicator-Signal Engine Load Fault !
D07L			Indicator Level Diesel-Reservoir Fault !
D08L		D031	Disconnected Truck Interface Diesel Start - D031 !
D09L		D031	Overload Truck Interface Diesel Start - D031 !
D10L		D032	Disconnected Truck Interface Diesel Stop - D032 !
D11L		D032	Overload Truck Interface Diesel Stop - D032 !
D12L		D033	Disconnected Truck Interface RPM (+) - D033 !
D13L		D033	Overload Truck Interface RPM (+) - D033 !
D14L		D034	Disconnected Truck Interface RPM (-) - D034 !
D15L		D034	Overload Truck Interface RPM (-) - D034 !

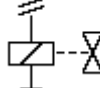

D16H		! Machine Safety Stop ! High Truck Coolant Temperature !
D17H		! Machine Safety Stop ! Low Truck Oil Pressure !
D18H		! Machine Safety Stop ! Low Level Hydraulic Oil !
D19H		! Machine Safety Stop ! Battery charging On Truck Fault !

M = Machine

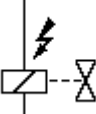
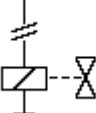
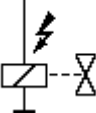
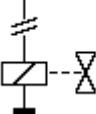
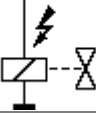
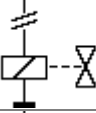
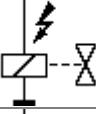
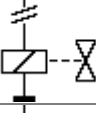
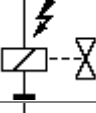
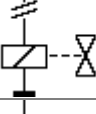
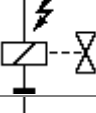



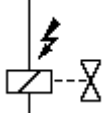
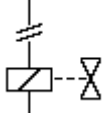
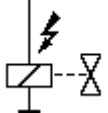
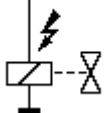

M01M		Ball Injector Activated !
M02M		End-Hose Shut-Off Activated !
M03L		Temperature Transmitter Hydraulic Oil Fault !
M04L		Hydraulic Oil Filter BOOM Contaminated ! Please Exchange Filter!
M05L		Hydraulic Oil Filter CP Contaminated ! Please Exchange Filter!
M06L		Low Level Hydraulic Oil Reservoir !
M07L		High Temperature Air Compressor !

M08L			Level Transmitter Hydraulic Reservoir Fault !
M09L			Transmitter Oil Pressure Service Fault !
M10L			Transmitter Cleaning Ball Detection Fault !
M11L		DO13	Disconnected PowerOutput Oil Cooler - DO13 !
M12L		DO13	Overload / Fuse PowerOutput Oil Cooler - DO13 !
M13L		DO12	Disconnected PowerOutput Vibrator - DO12 !
M14L		DO12	Overload / Fuse PowerOutput Vibrator - DO12 !
M15L		DO16	Disconnected PowerOutput Horn Boom C - DO16 !
M16L		DO16	Overload / Fuse PowerOutput Horn Boom C - DO16 !
M17L		DO17	Disconnected PowerOutput Horn Slew - DO17 !
M18L		DO17	Overload / Fuse PowerOutput Horn Slew - DO17 !
M19L		DO38	Disconnected Solenoid Ball-Injector - DO38 !







M20L		D038	Overload Solenoid Ball-Injector - D038 !
M21L		D026	Disconnected Solenoid Water Pump - D026 !
M22L		D026	Overload Solenoid Water Pump - D026 !
M23L		D028	Kabelbruch Schaltventil Kompressor - D028 !
M24L		D028	Disconnected Solenoid Air-Compressor - D028 !
M25L		D021	Disconnected Solenoid Agitator Forward - D021 !
M26L		D021	Overload Solenoid Agitator Forward - D021 !
M27L		D022	Disconnected Solenoid Agitator Reverse - D022 !
M28L		D022	Overload Solenoid Agitator Reverse - D022 !
M29L		D025	Disconnected Solenoid Hydraulic On Outriggers - D025 !
M30L		D025	Overload Solenoid Hydraulic On Outriggers - D025 !
M31L		D027	Disconnected Solenoid High Pressure Water Pump - D027 !

M32L		DO27	Overload Solenoid High Pressure Water Pump - DO27 !
M33L		DO37	Disconnected Solenoid End-Hose Shut-Off - DO37 !
M34L		DO37	Overload Solenoid End-Hose Shut-Off - DO37 !
M35L		PO56	Disconnected / Overload Solenoid Hydraulic On Outrigger - PO56 !
M36H			! Machine Safety Stop ! Hydraulic Oil Temperature Exceeded !

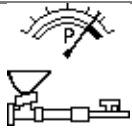
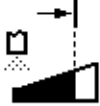
O = Optional

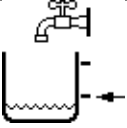



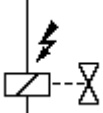
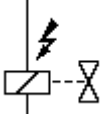
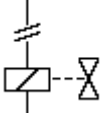
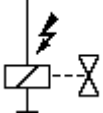

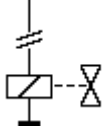
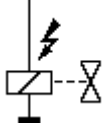
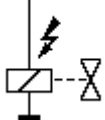

O01L		DO15	Disconnected PowerOutput Central Lubrication CP active / Pump - DO15!
O02L		DO15	Overload PowerOutput Central Lubrication CP active / Pump - DO15!
O03L		DO35	Disconnected Output Central Lubrication BOOM active - DO35 !
O04L		DO35	Overload Output Central Lubrication BOOM active - DO35 !
O05L		DO36	Disconnected LED-Output BOOM above rest - DO36 !
O06L		DO36	Overload LED-Output BOOM above rest - DO36 !

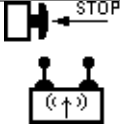

P = Pump

P01M			Pressure Limiter Concrete Pump Activated !
P02M			Stroke Rate Limitation Concrete Pump Activated !
P03M			Hopper Grate Open !
P04M			Low Level Water Reservoir !
P05L			Oil Temperature High, Power Limiter Concrete Pump Activated !
P06L			Transmitter Oil Pressure Concrete Pump Fault !
P07L			Prox-Switch Stroke Counter Fault or CP jammed !
P08L			Disconnected / Overload E-Stop Solenoid CP !
P09L			Disconnected / Overload E-Stop Solenoid MPS !
P10L		D023	Disconnected Solenoid Concrete Pump Forward - D023 !
P11L		D023	Overload Solenoid Concrete Pump Forward - D023 !





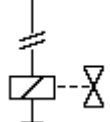
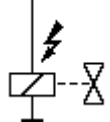

P12L		D024	Disconnected Solenoid Concrete Pump Reverse - D024 !
P13L		D024	Overload Solenoid Concrete Pump Reverse - D024 !
P14L		P055	Disconnected / Overload Solenoid Stroke Limiter - P055 !



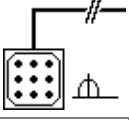









R = Remote



R01M		Emergency-Stop On Radio Control Box Activated !
R02M		Low Battery In Radio Control Box !
R03M		CAN-FST / Transmission With Remote Control Fault !
R04M		No Radio Control Transmission !
R05L		Joy-Stick 1 From Remote Control Fault !
R06L		Joy-Stick 2 From Remote Control Fault !
R07L		Joy-Stick 3 From Remote Control Fault !
R08L		Emergency-Stop Switch On Radio Control Box Fault !

R09L		Radio Control Signal With Faulty Address Received !
R10L		Disconnected Boom Release Solenoid !
R11L		Overload Boom Release Solenoid !
R12H		! Machine Safety Stop ! Hydraulic Enable Fault!

S = System

S01M		Disconnected Rear Panel !
S02L		Power Supply MAIN-Board Fault !
S03L		Power Supply MMI-Board Fault !
S04L		CAN-Communication to MMI or MMI-Board Fault !
S05L	 K 13	Relay Contact K 13 Override / Fault !
S06L	 F 18	Fuse F 18 Fault !

S07L		F 20	Fuse F 20 Fault !
S08L		F 16	Fuse F 16 Fault !
S09L		F 31	Fuse F 31 Fault !
S10L		F 32	Fuse F 32 Fault !
S11L		MF1	MF1 : Power Supply Diagnosis E-Stop Board DI15 - DI18 Fault !
S12L		MF2	MF2 : Power Supply Truck Interface etc. DI21 - DI27 Fault !
S13L		MF3	MF3 : Power Supply DI28,DI38,DI46,DI48 Fault !
S14L		MF4	MF4 : Power Supply DI31-DI37,DI43,DI44 Fault !
S15L		MF5	MF5 : Power Supply DI36,DI37,DI45 Fault !
S16L		MF6	MF6 : Power Supply DI41,DI42,DI47,AI21,AI22 Fault !
S17L		MF7	MF7 : Power Supply RAM-Change Station DI51-DI54 Fault !
S18L		MF8	MF8 : Power Supply DI55 - DI58 Fault !

S19L		Reference Voltage for analog Sensors AI12, AI13, AI14, AI16 Fault !
S20L		Multi Fuse MMI-Board Fault !

SCHWING – Control system " VECTOR "

TEACH MODE

The present summarized instructions are intended to serve as a 'memory aid'. They do not refer to any particular type of machine and do not relieve the user of familiarizing himself with the operating manual of the machine in question.



ATTENTION: RISK OF ACCIDENTS AND DAMAGE

The activities described in the present summarized instructions may only be performed by specially trained persons having demonstrated their ability to do such work.

SCHWING does not assume any liability for damage resulting from inappropriate attempts to perform machine adjustments.

The movement speeds must not be increased beyond the maximum values preset at the factory.

The electronic key used for boom speed programming is identified by the system and the key number is saved in the machine-specific parameter set. Persons authorized for programming of the system are obliged not to hand this key over to non-authorized persons.

For controlling of the the truck-mounted concrete pump during testing and adjustment, the operating instructions of the machine concerned and of the pertaining radio remote-control unit must be observed.

For training please contact:

SCHWING GmbH
After-sales service
Postfach 200362

D - 44647 Herne

Tel. : +49 (0)2325 / 987-0*
Fax : +49 (0)2325 / 74674
Telex : 820352

or your local SCHWING representative.

PROGRAMMING OF BOOM FUNCTIONS

In the so-called teach mode, the movement speeds of the boom can be readjusted within certain fixed limits.



ATTENTION
During the setting procedure, the boom performs movements.

The teach mode is started at the transmitter of the radio remote-control box. To start:

- Switch on the machine control.
- Select REMOTE control.
- Activate the radio remote-control system.
- Start the engine and adjust to maximum.
- Plug the TEACH key (Fig. 1) into the upper connector on the left side of the VECTOR control cabinet (Figs. 2+3) and secure with the screws.

Attention: the key is going in to the connector, one way.

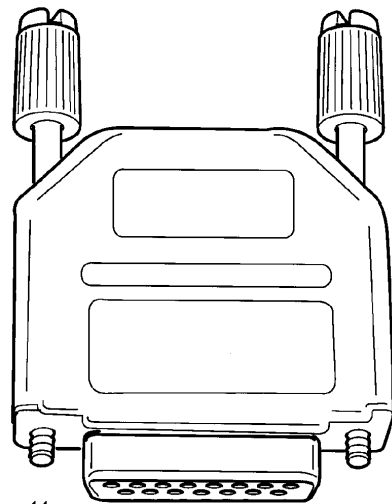

Fig. 1

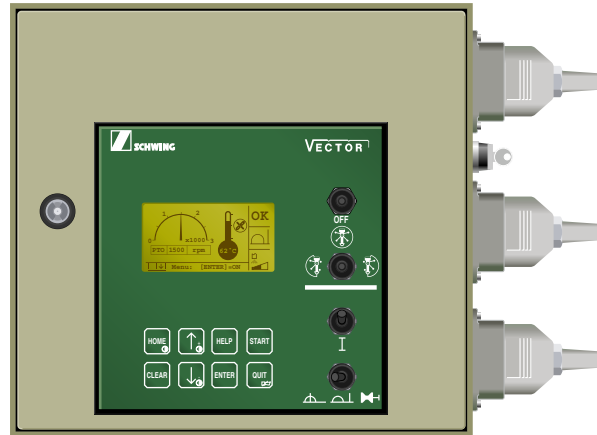

Fig. 2

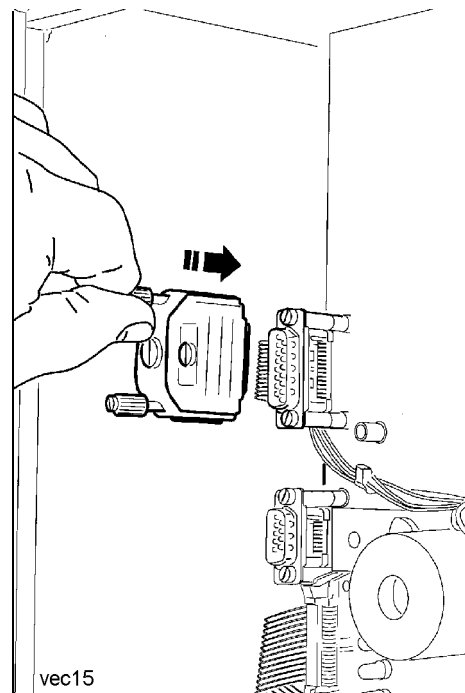

Fig. 3



Screen (Fig. 1) is displayed and START is flashing.



- Start the control with the pushbutton on the remote-control transmitter.



Successful starting is confirmed by a brief acoustic signal and the 'OK' symbol.

Screen (Fig. 2) is displayed.

In the teaching mode, the concrete pump and auxiliary unit functions are disabled.

The boom control and diesel engine functions are available without restrictions until the programming mode is activated.

To switch over to the teach mode:

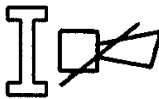

- Depress the pushbutton (fault acknowledgement) on the transmitter panel and **keep it depressed**.

- Select the function to be changed by setting the corresponding joystick to maximum position.

(With **ramp control**, select stage 3 and depress the button on the corresponding joystick.)



- Release the pushbutton (fault acknowledgement), but hold **joystick and / or button in activated position**.

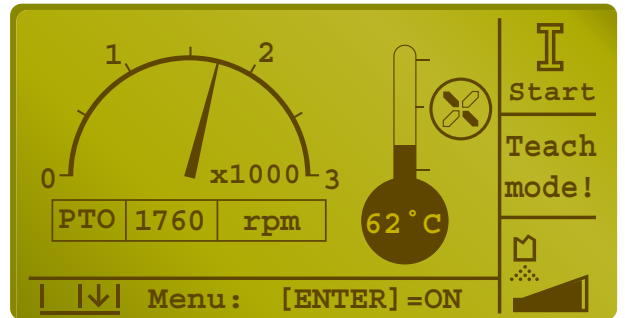

Fig. 1

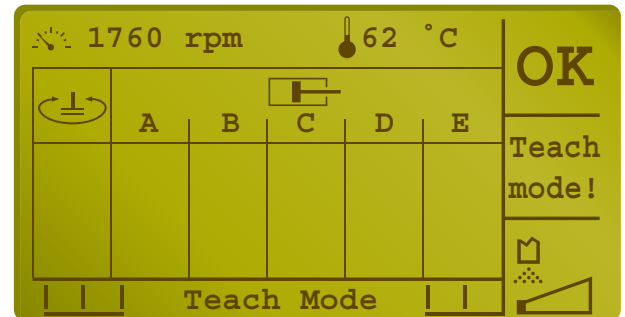

Fig. 2

PART 2

- 4 -

The selected boom function can now be programmed.

The minimum and maximum movement speed can be adjusted between fixed limits:

- Select the speed to be adjusted with the 'Snail / Rabbit' switch:



'Snail' = adjusts MIN value



'Rabbit' = adjusts MAX value

Depending on the value to be changed, the following screens are displayed:

Example 1:

Retracting boom section 1 (A), MIN value (snail)

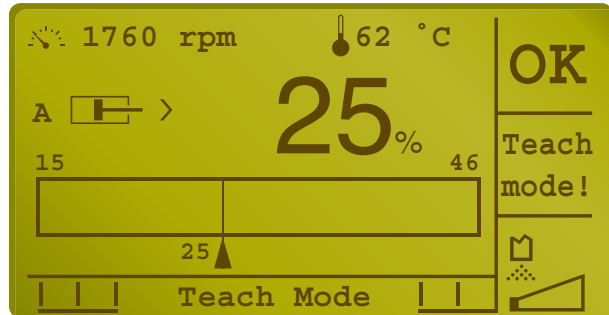

Fig. 1

Example 2:

Retracting boom section 1 (A), MAX value (rabbit)

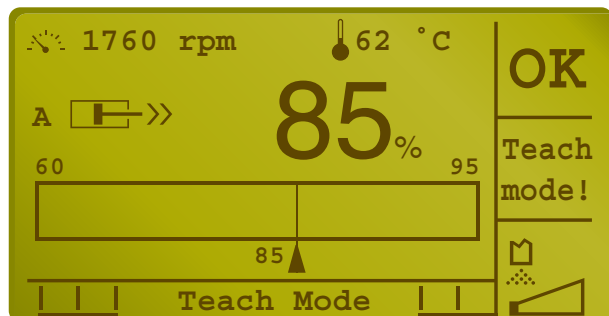

Fig. 2



- Change the value within the preset limits by depressing the RPM switch:

(+) = up

(-) = down

When either limit is reached, the value can only be changed in opposite direction.

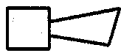

- Save the new value temporarily by depressing the horn button.

The indication that the new value was saved is displayed on the screen (example Fig. 1).

Important:

The set value is transmitted to the boom control valve as long as the joystick is held in actuated position.

Moving the joystick to neutral position or actuating the 'Snail / Rabbit' switch discards the new value.

After temporarily saving, the next boom function can be changed and temporarily saved in the same way.

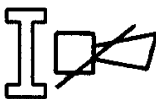

When the joystick is moved out of neutral position without depressing the pushbutton (fault acknowledge), the old or the newly saved values are displayed.

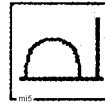

ñ When all values are OK, end the teach mode by switching over from remote-control to

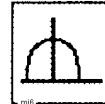

local control or to



piston replacement

Example:

Retracting boom section 1 (A), MAX value

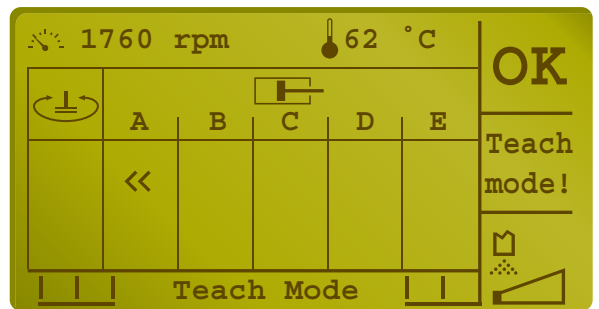
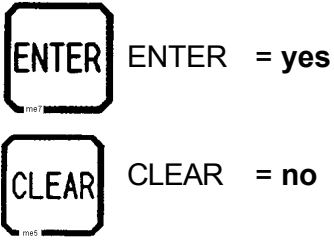

Fig. 1

To end the teach mode, the temporarily saved values must be saved permanently.

The values are permanently saved with the ENTER and CLEAR keys on the display panel 2 (Fig. 1)



If at least one new boom function has been saved, the screen displays the message of Fig. 2.

If the procedure is ended with YES (ENTER), the temporarily saved values are permanently saved in the machine set of parameters and the teach mode is terminated.

If NO (CLEAR) is pressed or if no boom function has been changed, the screen displays the message of Fig. 3.

If YES (ENTER) is pressed, the newly programmed values will be overwritten by the factory-adjusted set of parameters.

If NO (CLEAR) is pressed, the last values permanently saved will be maintained.

- Withdraw the teach key (Fig. 4) and restart the control unit.

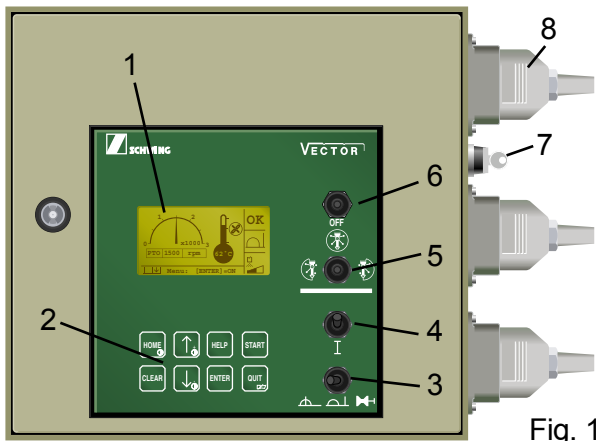

Fig. 1

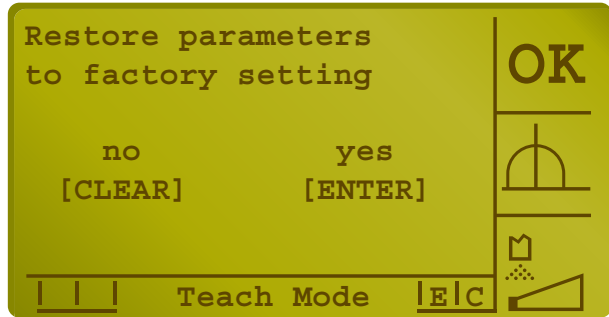

Fig. 2

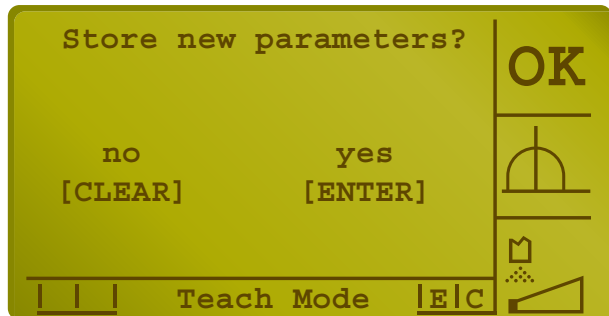

Fig. 3

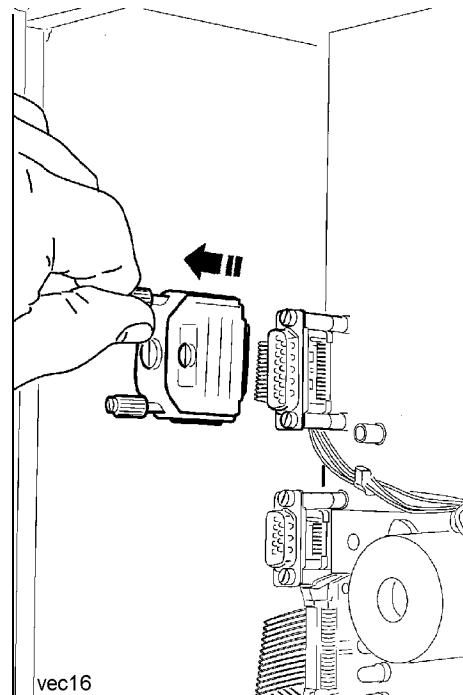

Fig. 4

PART 2

- 7 -

SUMMARY:

- Switch on the machine control.
- Select the REMOTE mode of operation.
- Activate the radio remote-control system.
- Start the engine and adjust to maximum RPM.
- Plug teach key into the connector of the control unit.

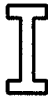

- Start the control unit.



Starting is acknowledged by a short acoustic signal and the symbol OK.



- Depress this button and **hold down**.

- Select the function to be adjusted by moving the corresponding joystick to maximum position.

(With **ramp control**, select stage 3 and depress the button on the respective joystick.)



- Release the horn button, leaving the joystick or the push button for boom #2 activated



- Select the value to be set:

MIN value

or



MAX value



- Change the value:

(+) = increase

or

(-) = decrease



- Save the new value temporarily.



- End the teach mode by switching over from remote control to

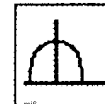

local control or to



piston replacement

- End the teach mode on the display panel.

- Withdraw the teach key and restart the control unit.