



VÖGELE

Hydraulikplan Hydraulic diagram

AB 220-3

28AB
Baureihe /
Series

0010 - XXXX
Seriennummer /
Serial No

13.10.2014
Ausgabedatum /
Date of issue

HFP_28AB_2390384_00_00_00
Katalog Bestellnummer /
Catalogue order No

Schutzvermerk nach ISO 16016

Weitergabe sowie Vervielfältigung dieses Dokuments, Verwertung und Mitteilung seines Inhalts sind verboten, soweit nicht ausdrücklich gestattet.

Zuwiderhandlungen verpflichten zum Schadenersatz. Alle Rechte für den Fall der Patent-, Gebrauchsmuster- oder Geschmacksmustereintragung vorbehalten.

Protection Notice ISO 16016

The reproduction, distribution and utilization of this document as well as the communication of its contents to others without explicit authorization is prohibited.

Offenders will be held liable for the payment of damages. All rights reserved in the event of the grant of a patent, utility model or design.

| Blatt / Sheet | Inhalt / Contents | Blatt / Sheet | Inhalt / Contents |
|---------------|---|---------------|-------------------|
| 1 | Deckblatt cover sheet | | |
| 2 | Inhaltsverzeichnis contents | | |
| 3 | Topologie V topology V | | |
| 4 | Bohle aus-/einfahren V screed extend/retract V | | |
| 5 | Vibrationsantrieb V advance vibration V | | |
| 6 | Topologie TV topology TV | | |
| 7 | Bohle aus-/einfahren TV screed extend/retract TV | | |
| 8 | Tamper- / Vibrationsantrieb TV advance tamper / vibration TV | | |
| 9 | Erklärung Aufbau Betriebsmittelkennzeichen Explanation device designation layout | | |
| 10 | Erklärung Gerätekenbuchstaben, hydraulisch Explanation device code letter, hydraulic | | |
| 11 | Erklärung Linienformate, Leitungsbezeichnungen explanation line formats, line designations | | |
| 12 | Betriebsmittelliste device list | | |

| | | | |
|--------------------|------------------------------|------------------------|----------------------|
| Drawing by: | Approved by: | Status: | Material No.: |
| date 12.05.2014 | date 13.10.2014 | AE = change | 2390384 |
| name Holzmann | name Holzmann | PF = prototype release | Revision No. 00 |
| E - CAE | Document type: HFP | SF = serial release | |

| | |
|--|-----------------------|
| Document No.: Partial Document No.: | Version No.: |
| Series code: 28AB | Valid for Serial No.: |
| Sheet plant: Sheet Location: | from 0010 to XXXX |



Inhaltsverzeichnis
contents

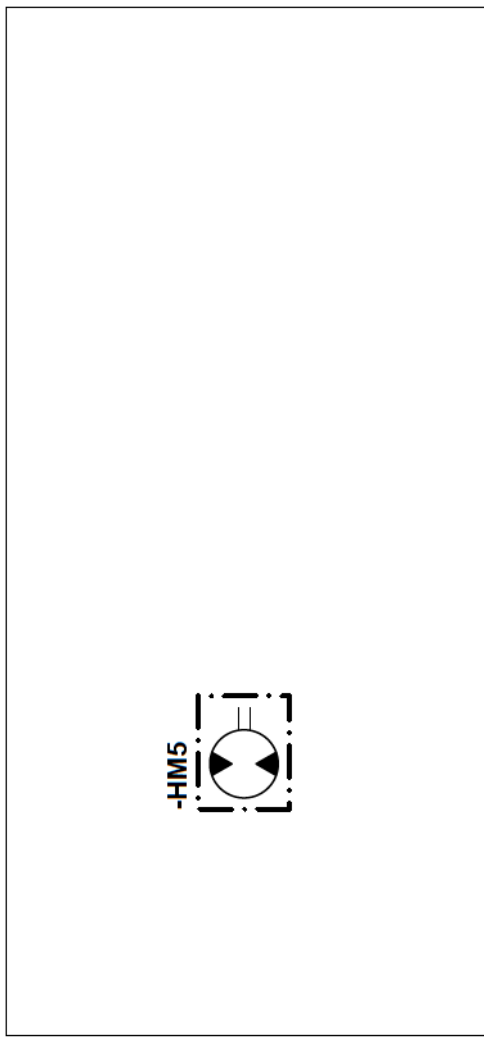
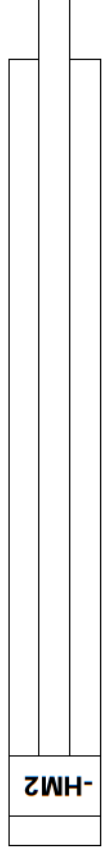
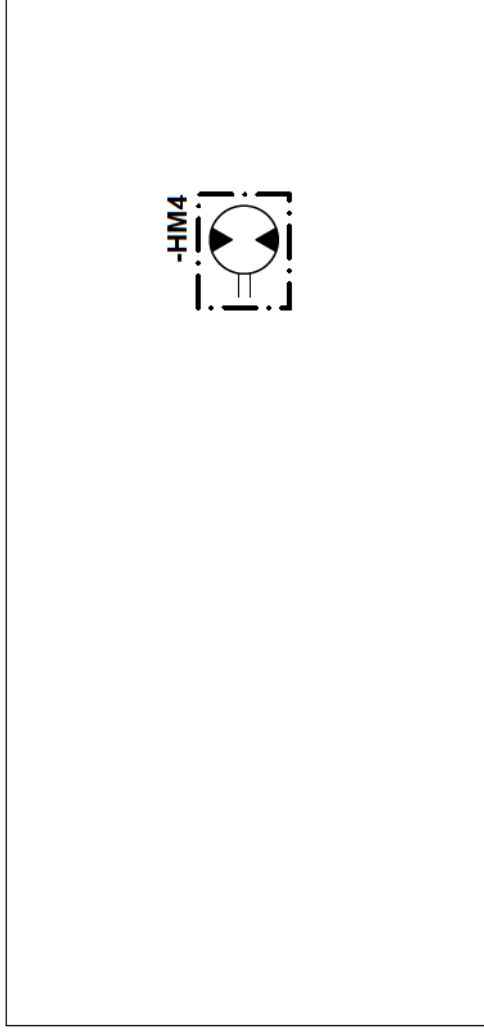
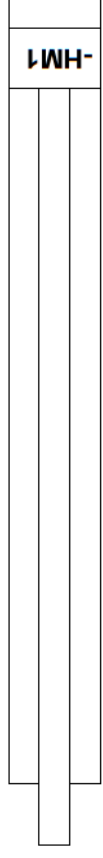
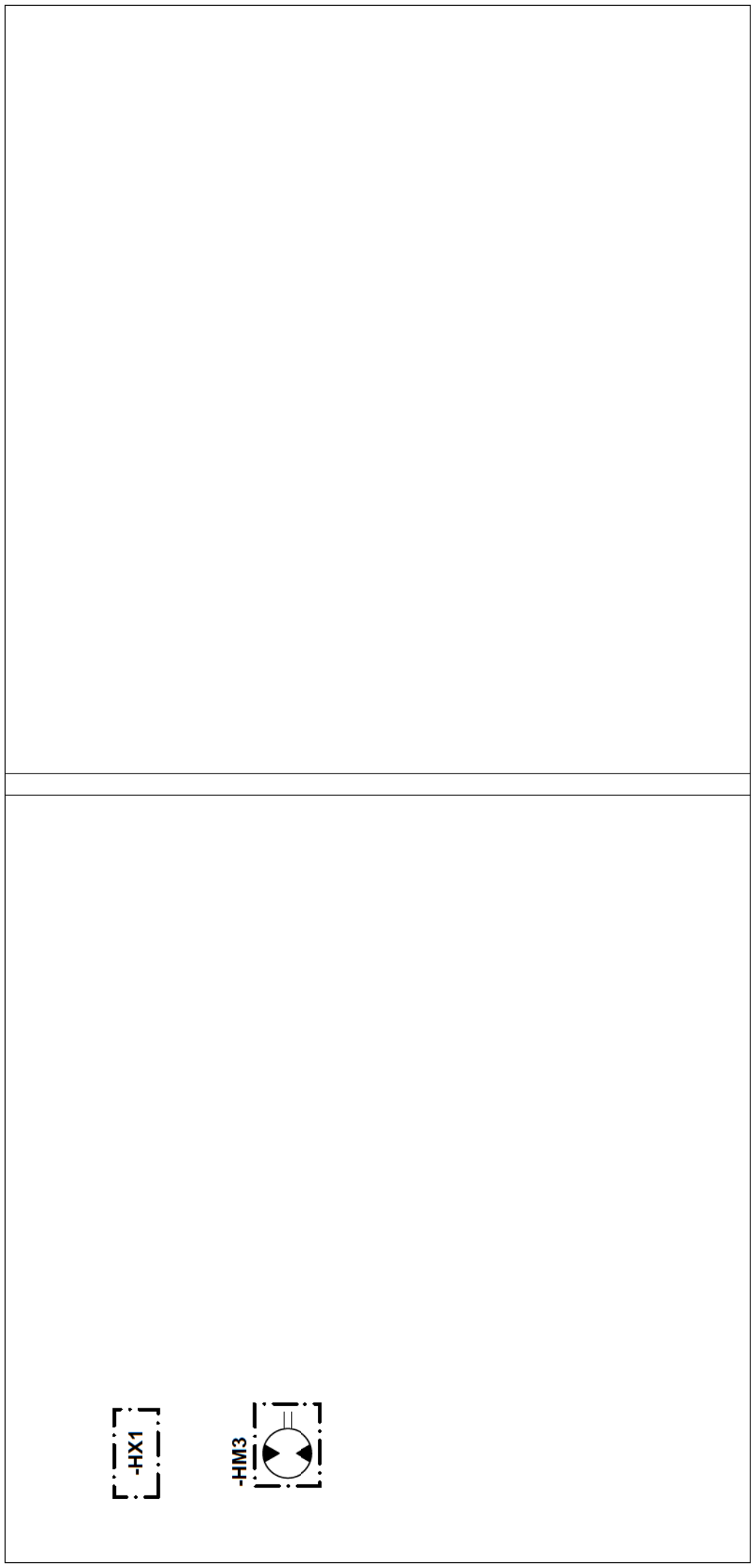

| | | | | | | |
|--------------------|---------------------|---------------------|------------------------|----------------------|-----------------------|---------------------|
| Drawing by: | Approved by: | last change: | Status: | Material No.: | Document No.: | Version No.: |
| date 12.05.2014 | date 13.10.2014 | date | AE = changeable | 2390384 | Partial Document No.: | |
| name Holzmann | name Holzmann | name | PF = prototype release | Revision No.: | | |
| E - CAE | Document type: | Function group No.: | SF | 00 | | |
| | HFP | | SF = serial release | | | |



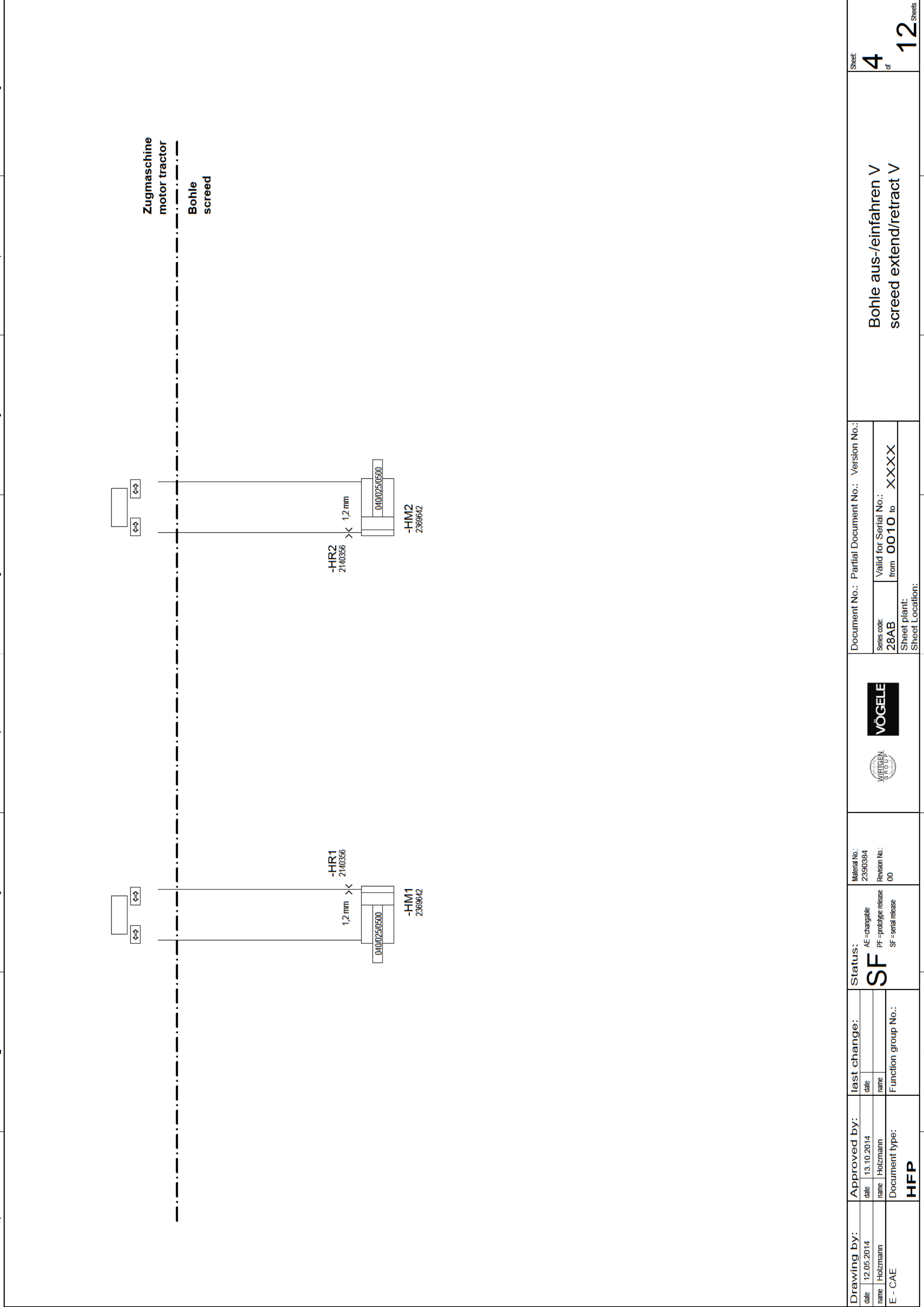

| | |
|-----------------|-----------------------|
| Series code: | Valid for Serial No.: |
| 28AB | from 0010 to XXXX |
| Sheet plant: | |
| Sheet Location: | |

Topologie V
topology V

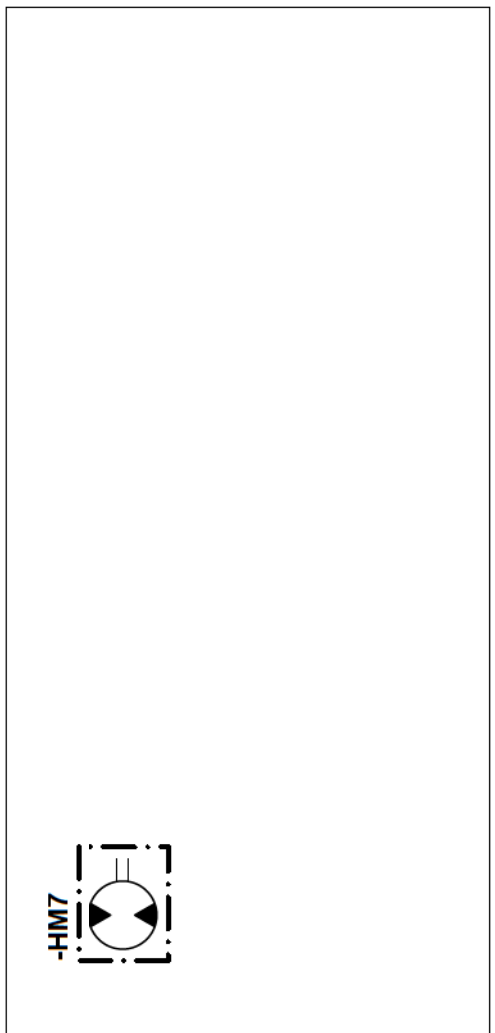
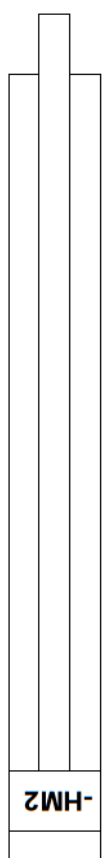
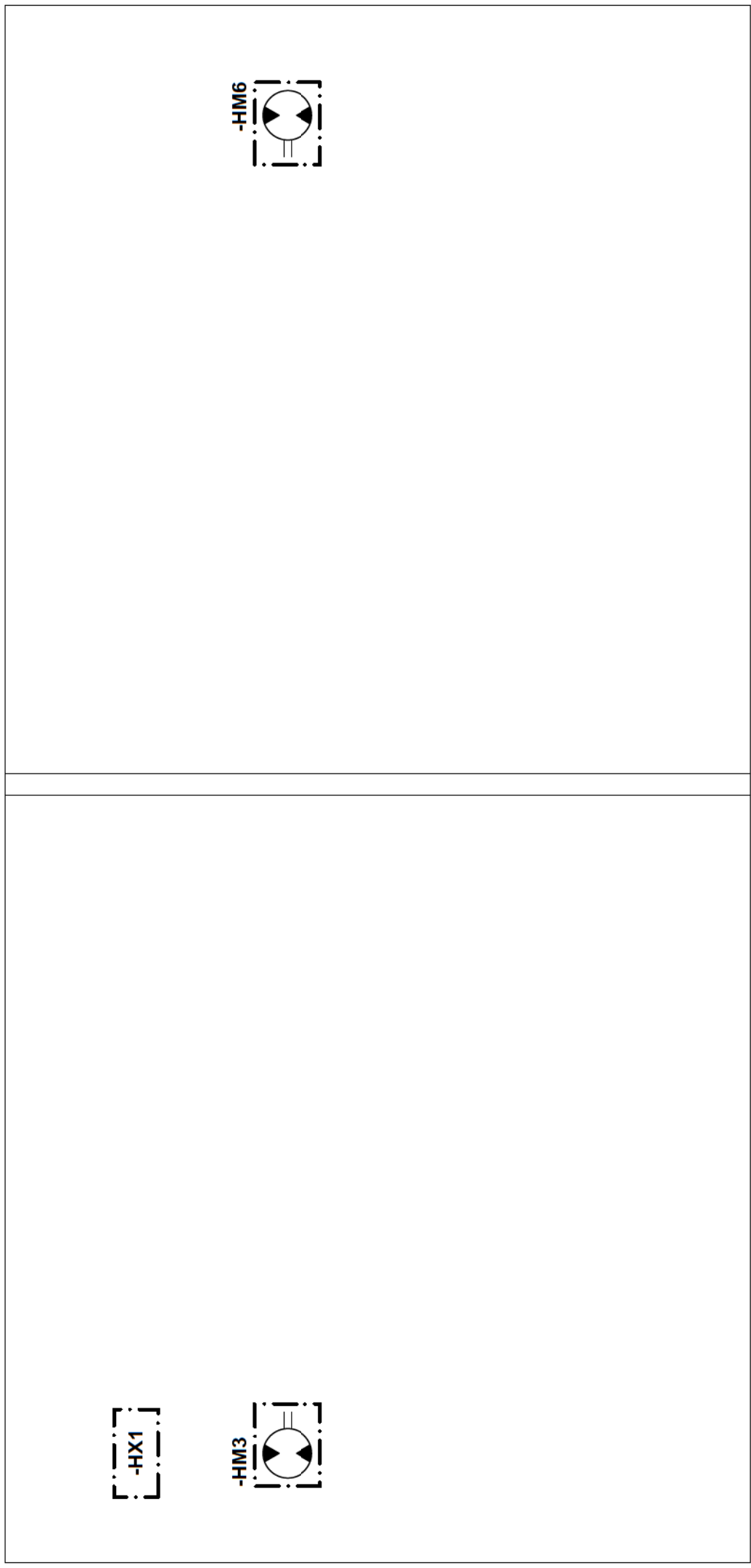

| | | | | | | |
|--------------------|---------------------------|---------------------|------------------------|----------------------|-----------------------|---|
| Drawing by: | Approved by: | last change: | Status: | Material No.: | Document No.: | Version No.: |
| date 12.05.2014 | date 13.10.2014 | date | AE = changeable | 2390384 | Partial Document No.: | |
| name Holzmann | name Holzmann | name | PF = prototype release | Revision No. 00 | Series code: 28AB | Valid for Serial No.: from 0010 to XXXX |
| E - CAE | Document type: HFP | Function group No.: | SF | | Sheet plant: | |
| | | | SF = serial release | | Sheet Location: | |

| | | |
|---|--|-------------------------|
| Bohle aus-/einfahren V screed extend/retract V | | Sheet 4 of 12 Sheets |
|---|--|-------------------------|



| | | | | | | |
|--------------------|---------------------|---------------------|------------------------|----------------------|-----------------------|---------------------|
| Drawing by: | Approved by: | last change: | Status: | Material No.: | Document No.: | Version No.: |
| date 12.05.2014 | date 13.10.2014 | date | AE = changeable | 2390384 | Partial Document No.: | |
| name Holzmann | name Holzmann | name | PF = prototype release | | Valid for Serial No.: | |
| E - CAE | Document type: | Function group No.: | SF | Revision No.: | from 0010 to XXXX | |
| | HFP | | SF | 00 | Sheet plant: | |
| | | | SF | | Sheet Location: | |

Topologie TV
topology TV

Sheet: **6** of **12** Sheets

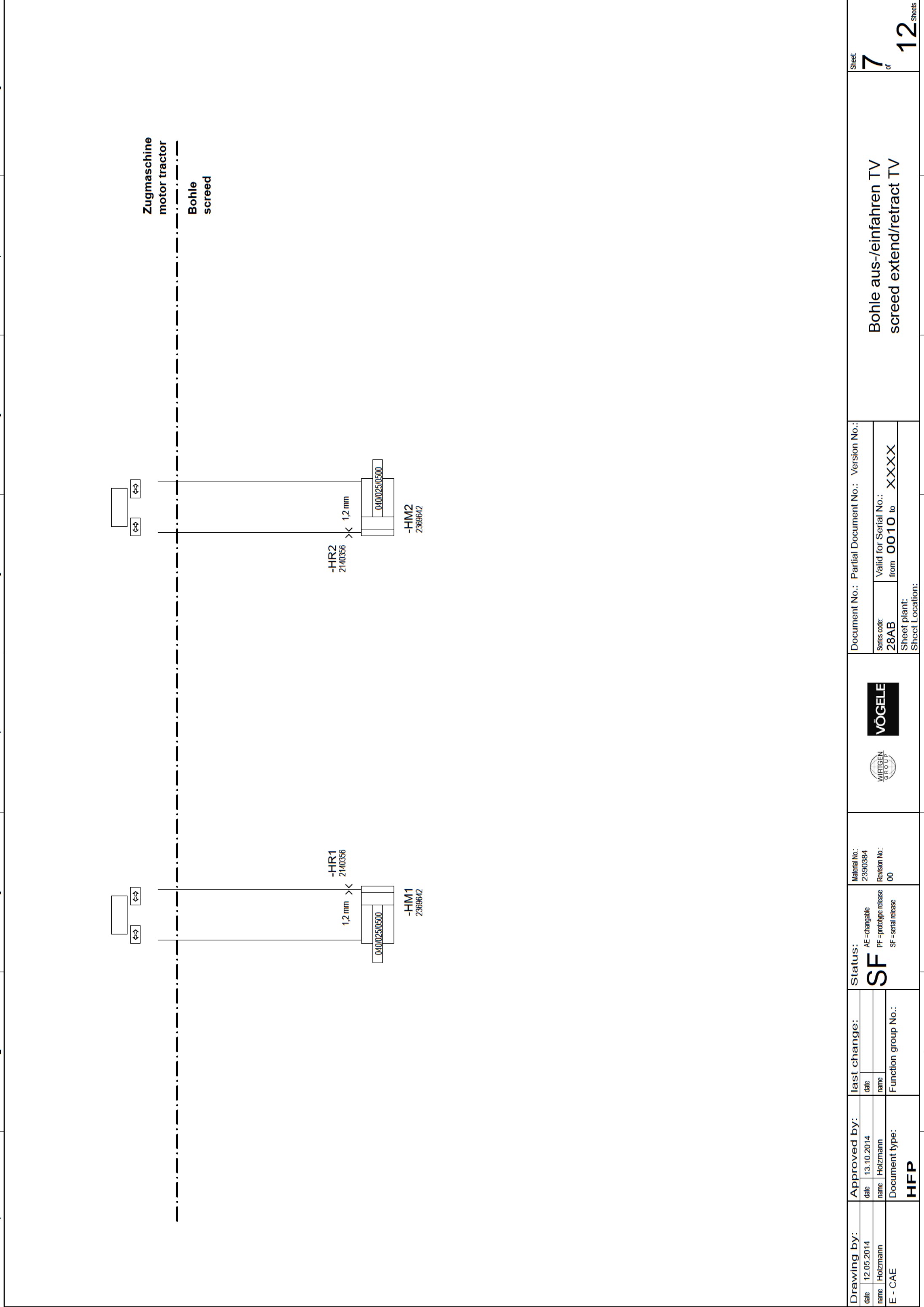

| | | | | | | | | | | | | | | | | | |
|-------------|------------|----------------|------------|---------------------|--|--|--|---------------|---------------|---------------|--------------|-----------------------|-----------------------|--------------|------------|----|--|
| Drawing by: | | Approved by: | | last change: | | Status: | | Material No.: | | Document No.: | | Partial Document No.: | | Version No.: | | | |
| date | 12.05.2014 | date | 13.10.2014 | date | | SF | | 2390384 | Revision No.: | | Series code: | | Valid for Serial No.: | | Sheet No.: | | |
| name | Holzmann | name | Holzmann | name | | AE = changeable PF = prototype release SF = serial release | | 00 | Revision No.: | | 28AB | | from 0010 to XXXX | | 7 | | |
| E - CAE | | Document type: | | Function group No.: | | | | | | | | | | | | of | |
| | | HFP | | | | | | | | | | | | | | 12 | |

| | | | | | | | | | | | | | |
|-------------------------|--|--------------------------|--|------------|--|---|--|----|--|----|--|--------|--|
| Bohle aus-/einfahren TV | | screed extend/retract TV | | Sheet No.: | | 7 | | of | | 12 | | Sheets | |
|-------------------------|--|--------------------------|--|------------|--|---|--|----|--|----|--|--------|--|

Aufbau Betriebsmittelkennzeichen / device designation configuration

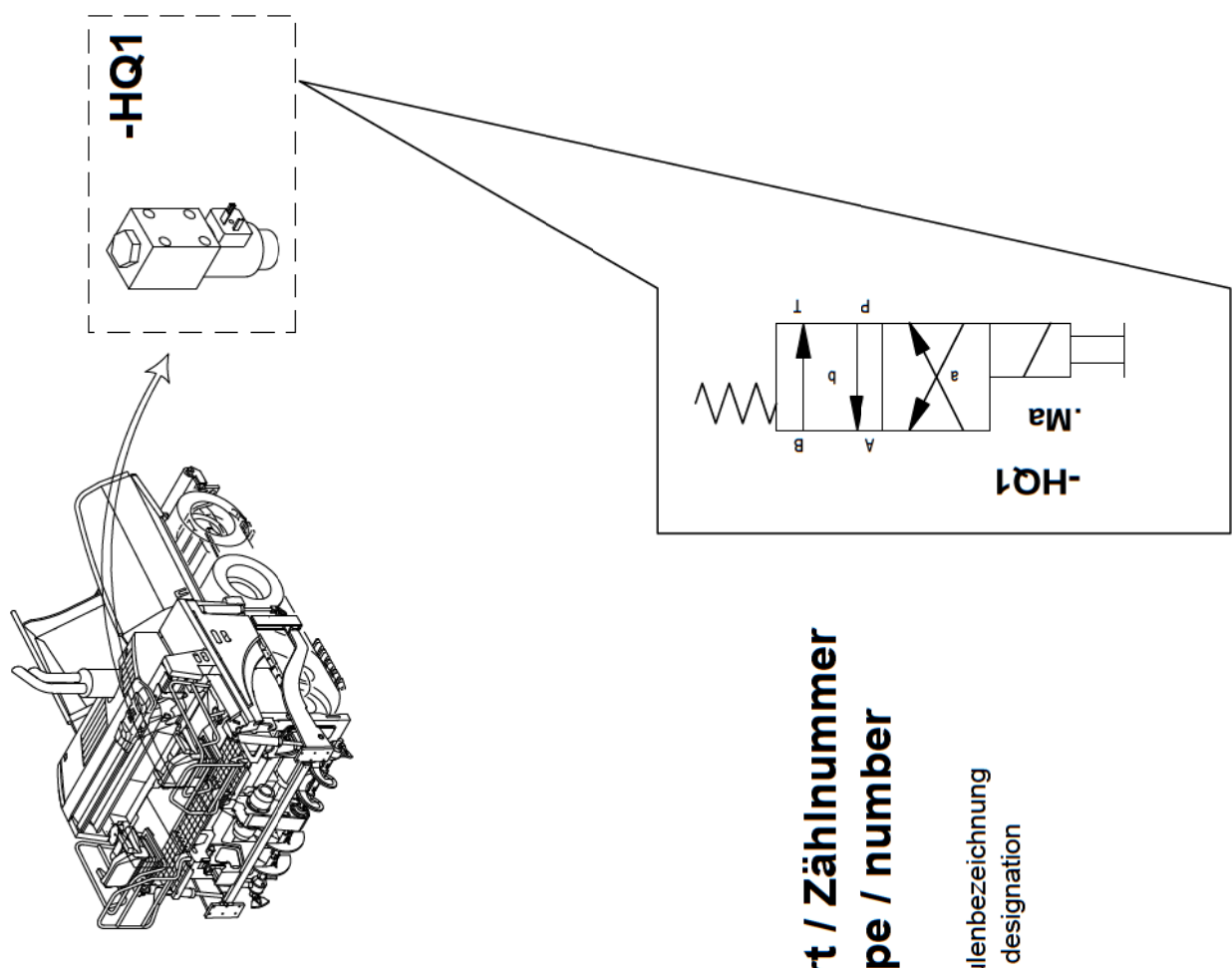

- Art / Zählnummer
type / number

• Spulenbezeichnung
coil designation

| | | |
|--------------------|---------------------------|---------------------|
| Drawing by: | Approved by: | last change: |
| date 12.05.2014 | date 13.10.2014 | date |
| name Holzmann | name Holzmann | name |
| E - CAE | Document type: HFP | Function group No.: |

| |
|------------------------|
| Status: |
| SF |
| AE = changeable |
| PF = prototype release |
| SF = serial release |

| |
|-----------------------|
| Material No.: 2390384 |
| Revision No.: 00 |

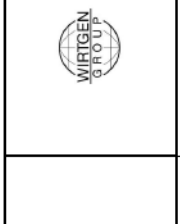

| | |
|--|---|
| Document No.: Partial Document No.: Version No.: | |
| Series code: 28AB | Valid for Serial No.: from 0010 to XXXX |
| Sheet plant: | Sheet Location: |

Erklärung Aufbau Betriebsmittelkennzeichen
Explanation device designation layout

Gerätekenbuchstaben, hydraulisch (beispielhaft) / device code letter, hydraulic (exemplified)

| <u>Gerätekenbuchstabe/ device code letter</u> | <u>Deutsch</u> | <u>English</u> | <u>Gerätekenbuchstabe/ device code letter</u> | <u>Deutsch</u> | <u>English</u> |
|---|--|---|---|--|--|
| - HA | Ventilblock | valve-block | - HP | Manometer | pressure gauge |
| - HB | Durchflussmesser Durchflusswächter Druckschalter hydraulisch | flow measuring device flow controller hydraulic pressure switch | - HQ | Bremsventil Kugelhahn Lenkeinheit Wegeventil | braking valve ball valve steering unit direction control valve |
| - HC | Speicher | accumulator | - HR | Drosselventil Drosselrückschlagventil Druckreduzierventil Lasthalteventil Rückschlagventil | throttle valve throttle check valve pressure reduction valve counter balance valve check valve |
| - HE | Kühler | cooler | - HT | Getriebe | gearbox |
| - HF | Druckbegrenzungsventil | pressure limiting valve | - HV | Hydraulikfilter | hydraulic filter |
| - HG | Hydraulikpumpe | hydraulic pump | - HX | Abdeckplatten Reihenflanschplatte Schnellkupplung | cover plates manifold plate quick-action coupling |
| - HK | Mengenteiler Prioritätsventil Stromregelventil | flow divider priority valve flow control valve | - Ma | Ventil Magnetspule a | valve coil a |
| - HM | Hydraulikmotor Hydraulikzylinder | hydraulic motor hydraulic cylinder | - Mb | Ventil Magnetspule b | valve coil b |

| | | | |
|----------------------------------|----------------------------------|---------------------|--|
| Drawing by: | Approved by: | Last change: | Status: |
| date 12.05.2014 name Holzmann | date 13.10.2014 name Holzmann | date name | AE = changeable PF = prototype release SF = serial release |
| E - CAE | Document type: HFP | Function group No.: | |

| | |
|---------------------------------|----------------------------|
| Material No.: 2390384 | Revision No.: 00 |
|---------------------------------|----------------------------|



| | |
|--|---|
| Document No.: Partial Document No.: | Version No.: |
| Series code: 28AB | Valid for Serial No.: from 0010 to XXXX |
| Sheet plant: | |
| Sheet Location: | |

Erklärung Gerätekenbuchstaben, hydraulisch
Explanation device code letter, hydraulic

| Betriebsmittelkennzeichen / Device designation | Blatt / Sheet | Betriebsmittelkennzeichen / Device designation | Blatt / Sheet | Betriebsmittelkennzeichen / Device designation | Blatt / Sheet |
|---|------------------|---|------------------|---|------------------|
| -HM1 | /4.3 | | | | |
| -HM2 | /4.5 | | | | |
| -HM3 | /5.3 | | | | |
| -HM4 | /5.3 | | | | |
| -HM5 | /5.6 | | | | |
| -HM6 | /8.6 | | | | |
| -HM7 | /8.6 | | | | |
| -HM8 | /8.3 | | | | |
| -HR1 | /4.3 | | | | |
| -HR2 | /4.5 | | | | |
| -HX1 | /5.1 | | | | |

| | | | |
|-----------------|------------------------------|---------------------|------------------------|
| Drawing by: | Approved by: | Last change: | Status: |
| date 12.05.2014 | date 13.10.2014 | date | AE = changeable |
| name Holzmann | name Holzmann | name | PF = prototype release |
| E - CAE | Document type: HFP | Function group No.: | SF |
| | | | SF = serial release |

| | |
|---------------|---------|
| Material No.: | 2390384 |
| Revision No.: | 00 |



| | | |
|---------------|-----------------------|--------------|
| Document No.: | Partial Document No.: | Version No.: |
| Series code: | Valid for Serial No.: | |
| 28AB | from 0010 to XXXX | |
| Sheet plant: | Sheet Location: | |

| | | |
|---------------------|--|-----------------|
| Betriebsmittelliste | | Sheet: |
| device list | | 12 of 12 Sheets |

1 2 3 4 5 6 7 8