

Schaltplanhistorie der Bohle AB 340 (13.AB)

History of the circuit diagrams for the screed AB 340 (13.AB)

| Materialnummer part number | von Masch. from machine | bis Masch. to machine | Benennung name | PC-Dateiname pc filename |
|-------------------------------|----------------------------|--------------------------|---------------------|--------------------------------|
| 2048159 E 02 | 13.AB 0001 | 13.AB XXXX | ESP_13.AB 0001-XXXX | ESP_13.AB_2048159_02_00_00.pdf |

Schutzvermerk nach ISO 16016 beachten / Refer to protection notice ISO 16016

| | | | | | |
|------------------|-------------------|------------------------------------------------------------------------------------------------------|----------------------------------|-----------------------------------|---------|
| a b c d | 10.05.10 Heindtel |  Joseph Vögele AG | Bohlenheizung 13.AB 0001-XXXX | 2048159 02 Historie history | 1 13 |
|------------------|-------------------|------------------------------------------------------------------------------------------------------|----------------------------------|-----------------------------------|---------|

Inhaltsverzeichnis 13.AB und VB

| | | |
|----------------------|--|---------------|
| Bohlenheizung AB 340 | | Seite 3 bis 8 |
| Heizung VB 0,24m | | Seite 9 |
| Heizung VB 0,40m | | Seite 10 |
| Heizung VB 0,55m | | Seite 11 |
| Heizung VB 0,80m | | Seite 12 |

Table of contents 13.AB and VB

| | | |
|-------------------------|--|------------|
| Screed heating system | | page 3 - 8 |
| Heating system VB 0,24m | | page 9 |
| Heating system VB 0,40m | | page 10 |
| Heating system VB 0,55m | | page 11 |
| Heating system VB 0,80m | | page 12 |

Schutzvermerk nach ISO 16016 beachten / Refer to protection notice ISO 16016

Ausziehbohle AB 340 TV 13.AB

Heizung (Grundbohle und Erweiterung)
heating system basic screed and extension

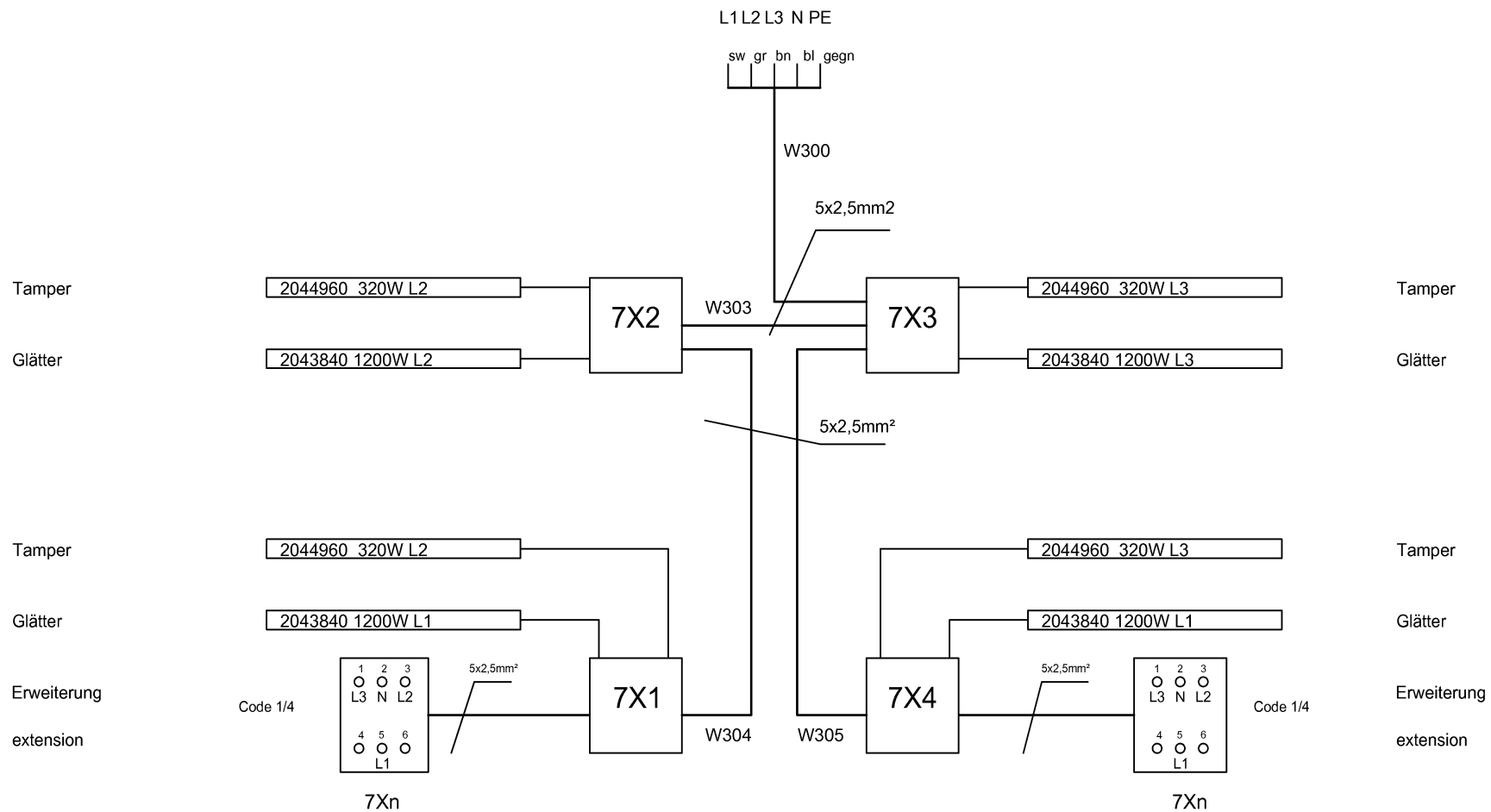

2048172

P ges TV=6,1kW

Schutzvermerk nach ISO 16016 beachten / Refer to protection notice ISO 16016

| | | | | | | |
|---|--|-------------------|--------------------------------|----------------------------------|----------------------------------------------------------|---------|
| a | | 10.05.10 Heindtel | VÖGELE Joseph Vögele AG | Bohlenheizung 13.AB 0001-XXXX | 2048159 02 Heizung AB 340 TV screed heating system | 3 13 |
| b | | | | | | |
| c | | | | | | |
| d | | | | | | |

Ausziehbohle AB 340 V 13.AB

Heizung (Grundbohle und Erweiterung)
heating system basic screed and extension

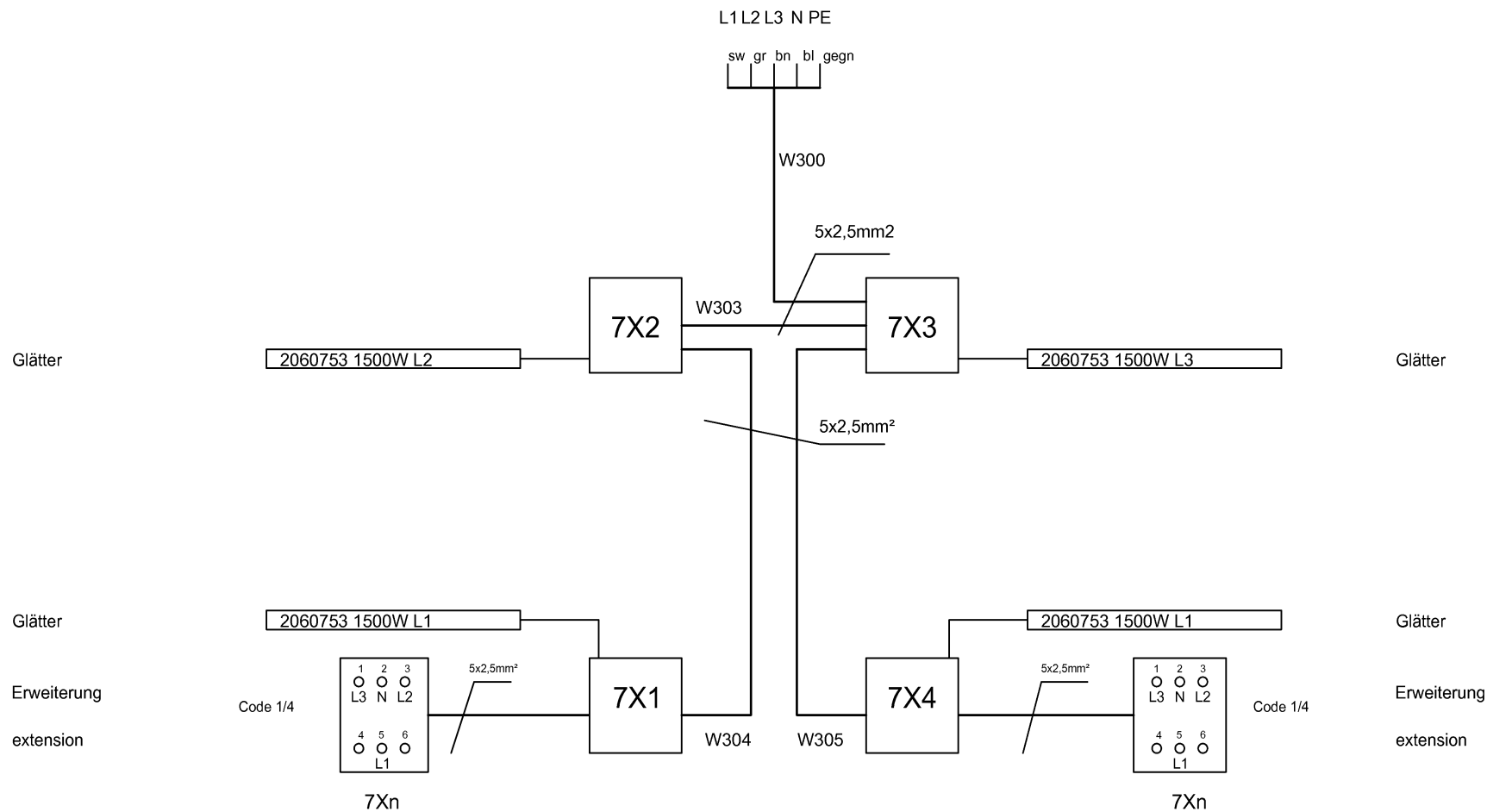

2048172

P ges V=6kW

Schutzvermerk nach ISO 16016 beachten / Refer to protection notice ISO 16016

| | | | | | | |
|---|--|-------------------|---------------|------------------|-----------------|-----------------------|
| a | | | | | | |
| b | | 10.05.10 Heindtel | VÖGELE | Joseph Vögele AG | Bohlenheizung | 2048159 02 |
| c | | | | | 13.AB 0001-XXXX | Heizung AB 340 V |
| d | | | | | | screed heating system |
| | | | | | | 4 |
| | | | | | | 13 |

Verteiler Ausziehteil links distributer left side

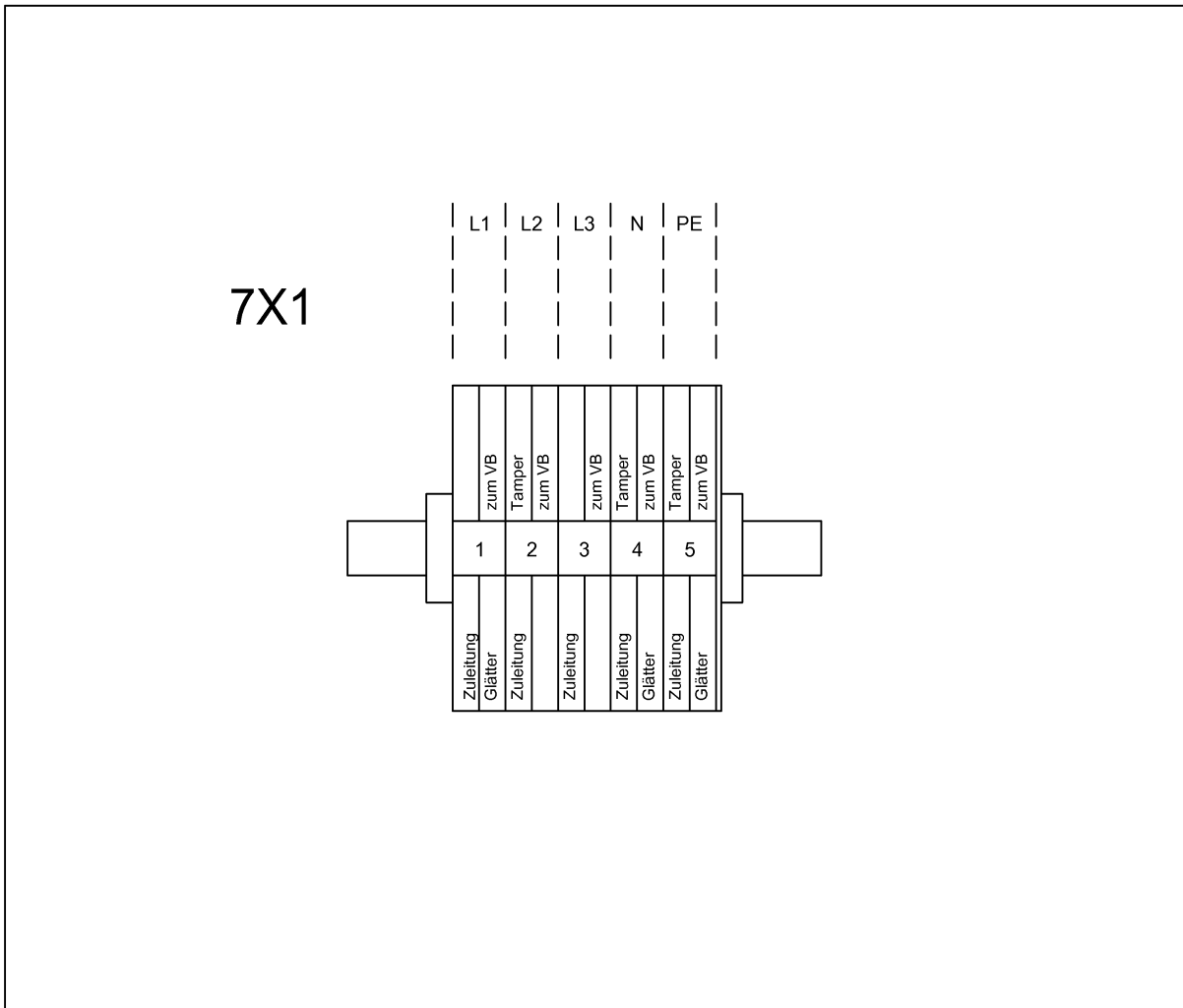

Schutzvermerk nach ISO 16016 beachten / Refer to protection notice ISO 16016

Verteiler Grundbohle distributor screed

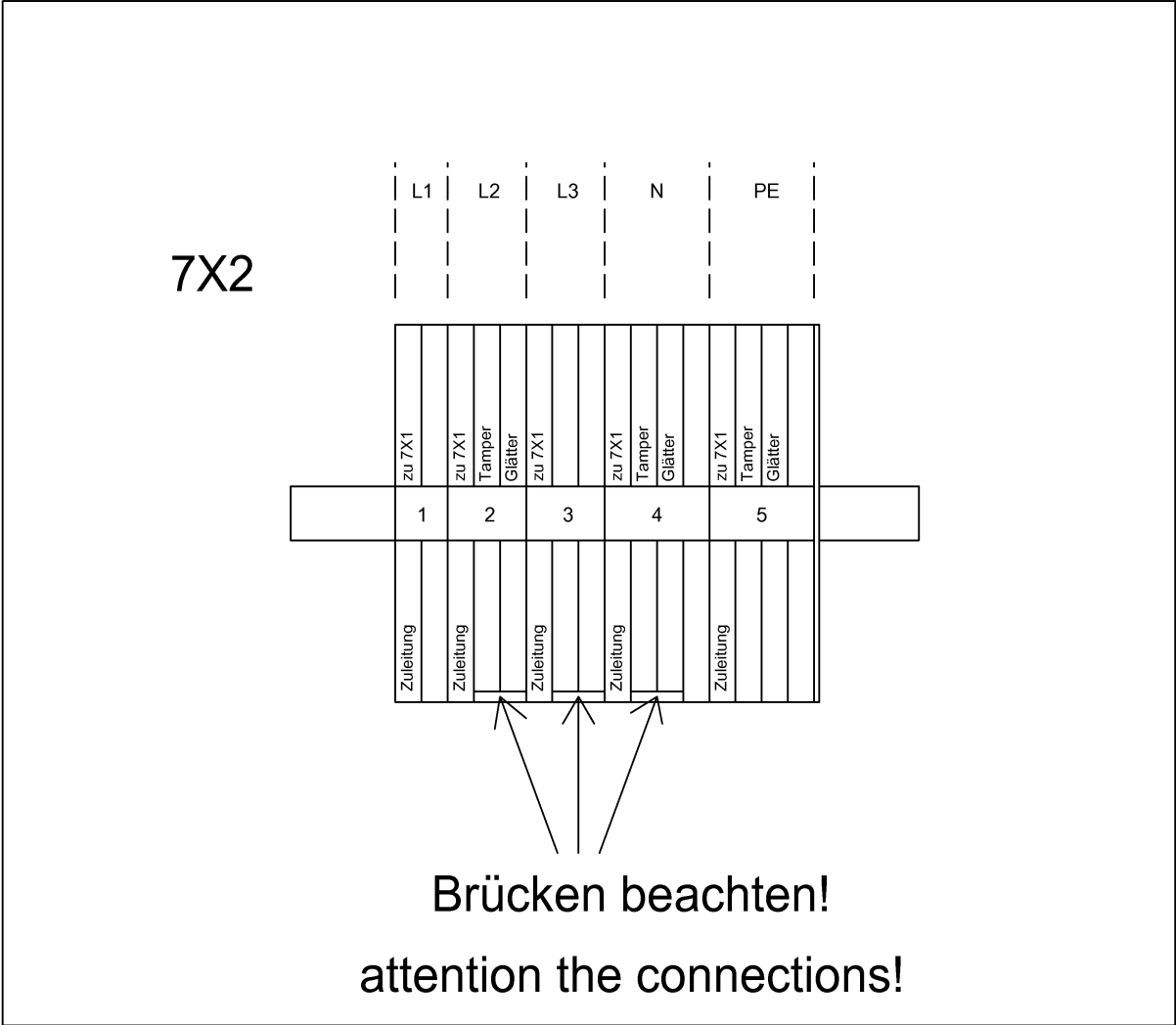

Schutzvermerk nach ISO 16016 beachten / Refer to protection notice ISO 16016

Verteiler Grundbohle distributer screed

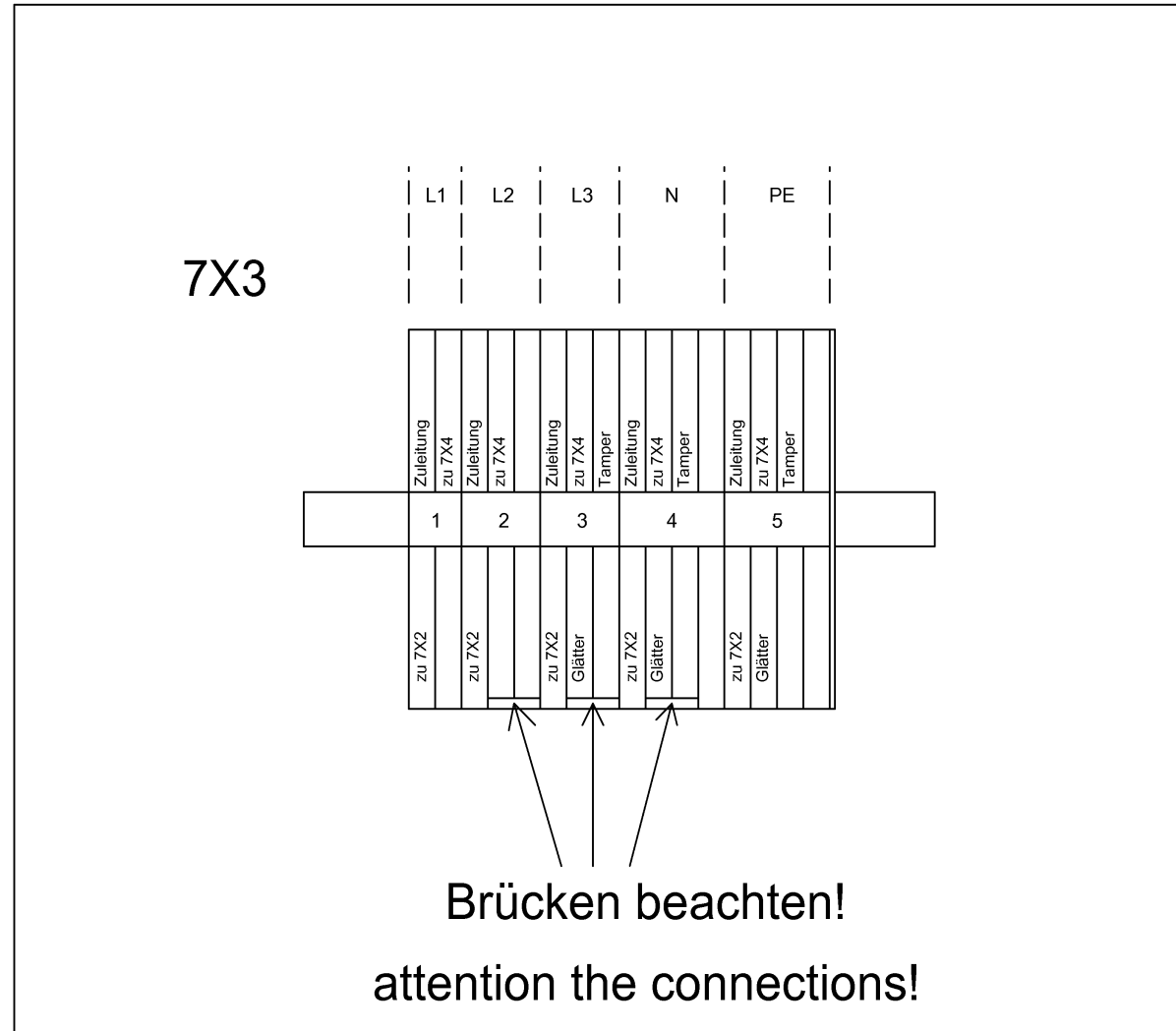

Schutzvermerk nach ISO 16016 beachten / Refer to protection notice ISO 16016

Verteiler Ausziehteil rechts distributor right side

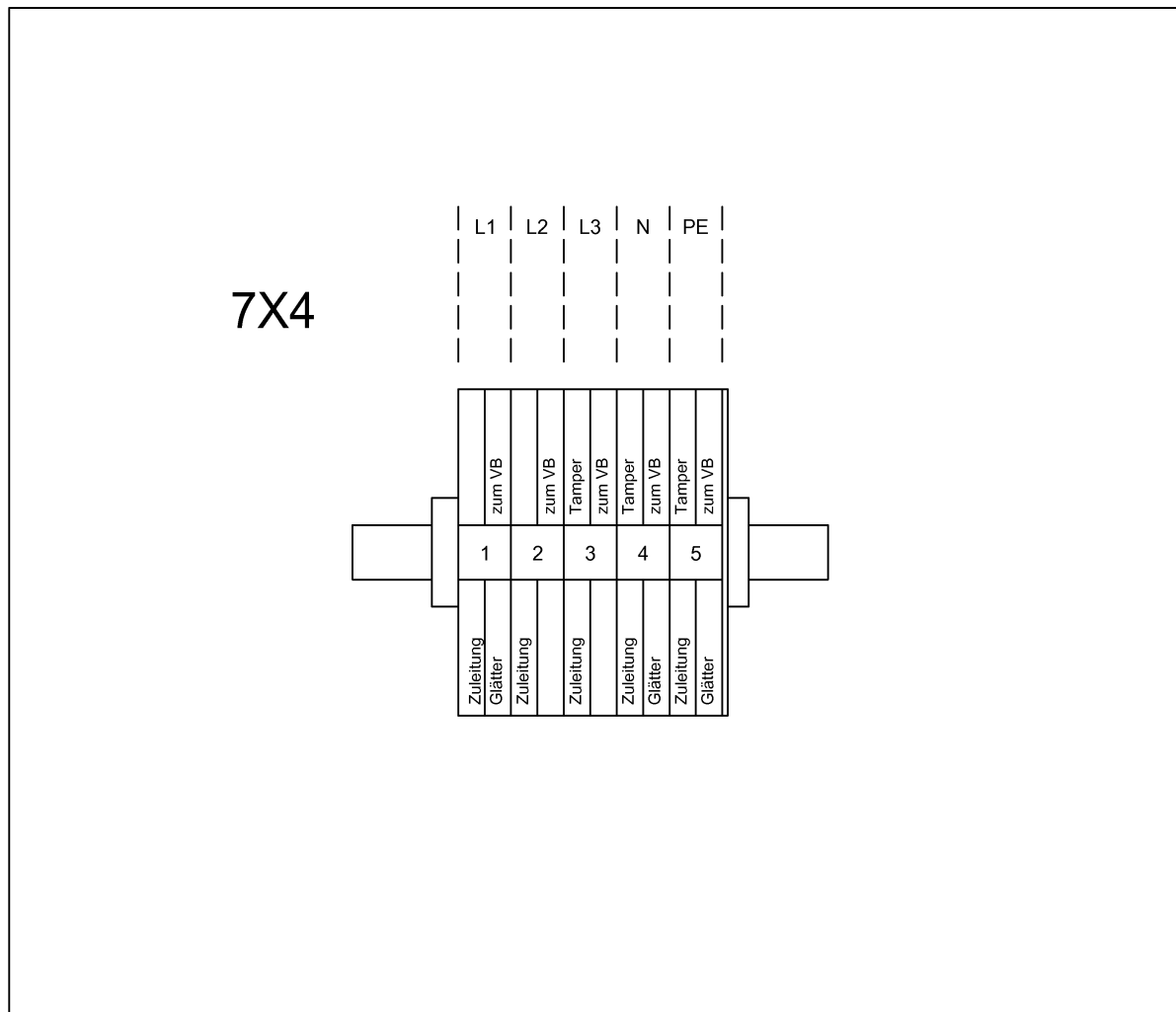

Schutzvermerk nach ISO 16016 beachten / Refer to protection notice ISO 16016

Verbreitungsteil (VB) 0,24m TV für 13.AB

P ges TV=1,00kW

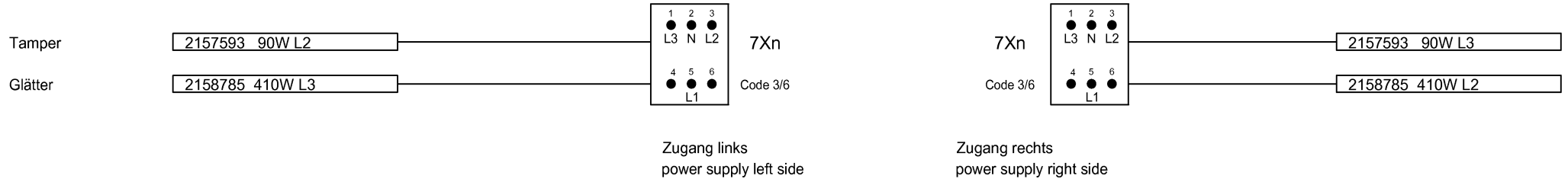

Schutzvermerk nach ISO 16016 beachten / Refer to protection notice ISO 16016

2014248

| | | | | | | | |
|------------------|--|----------|----------|------------------------------------------------------------------------------------------------------|----------------------------------|-------------------------------------------------|---------|
| a b c d | | 10.05.10 | Heindtel |  Joseph Vögele AG | Bohlenheizung 13.AB 0001-XXXX | 2048159 02 Heizung VB 0,24m TV commitment | 9 13 |
|------------------|--|----------|----------|------------------------------------------------------------------------------------------------------|----------------------------------|-------------------------------------------------|---------|

Verbreitungsteil (VB) 0,40m TV für 13.AB

P ges TV=1,34kW

Tamper

Glätter

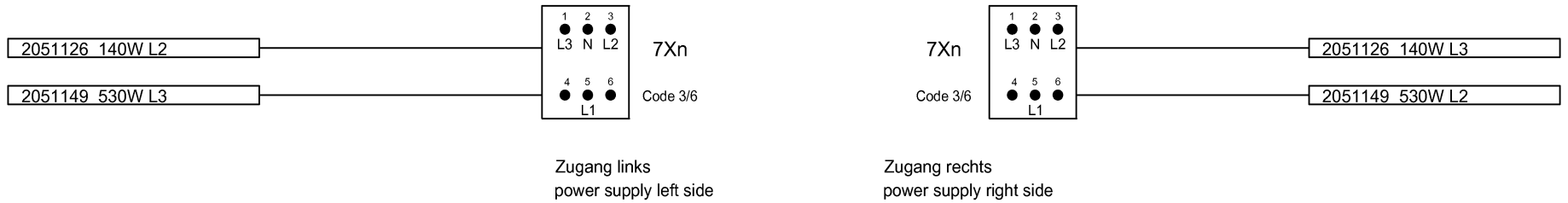

Verbreitungsteil (VB) 0,40m V für 13.AB

P ges V=1,4kW

Glätter

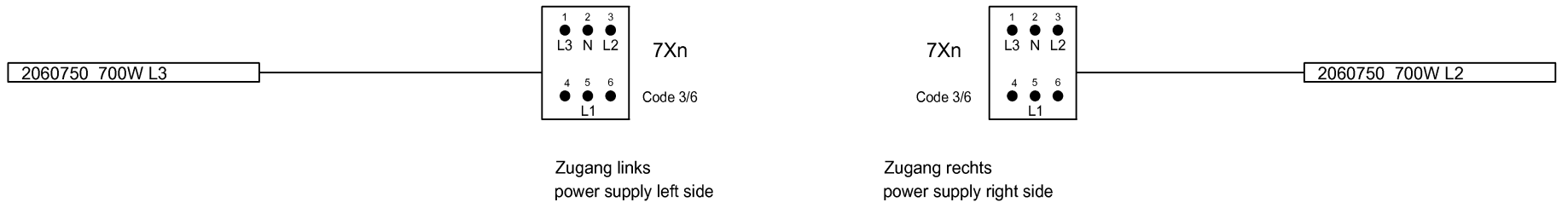

2014248

Schutzvermerk nach ISO 16016 beachten / Refer to protection notice ISO 16016

| | | | | | | |
|------------------|--|-------------------|------------------------------------------------------------------------------------------------------|----------------------------------|----------------------------------------------------------------|----------|
| a b c d | | 10.05.10 Heindtel |  Joseph Vögele AG | Bohlenheizung 13.AB 0001-XXXX | 2048159 02 Heizung VB 0,40m (T)V heating system VB 0,40m | 10 13 |
|------------------|--|-------------------|------------------------------------------------------------------------------------------------------|----------------------------------|----------------------------------------------------------------|----------|

Verbreitungsteil (VB) 0,55m TV für 13.AB

P ges TV=1,86kW

Tamper

Glätter

2047003 200W L1

2047175 730W L3

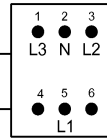

7Xn

Code 3/6

Zugang links
power supply left side

7Xn

Code 3/6

Zugang rechts
power supply right side

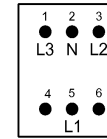

2047003 200W L3

2047175 730W L2

Verbreitungsteil (VB) 0,55m V für 13.AB

P ges V=1,86kW

Glätter

2063786 930W L3

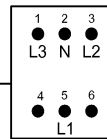

7Xn

Code 3/6

Zugang links
power supply left side

7Xn

Code 3/6

Zugang rechts
power supply right side

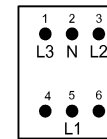

2063786 930W L2

2014248

Schutzvermerk nach ISO 16016 beachten / Refer to protection notice ISO 16016

| | | | | | | |
|------------------|--|-------------------|------------------|----------------------------------|---------------------------------------------------------------|----------|
| a b c d | | 10.05.10 Heindtel | Joseph Vögele AG | Bohlenheizung 13.AB 0001-XXXX | 2048159 02 Heizung VB0,55m (T)V heating system VB 0,55m | 11 13 |
|------------------|--|-------------------|------------------|----------------------------------|---------------------------------------------------------------|----------|

Verbreiterungsteil (VB) 0,8m TV für 13.AB

P ges TV=1,86kW

Tamper

Glätter

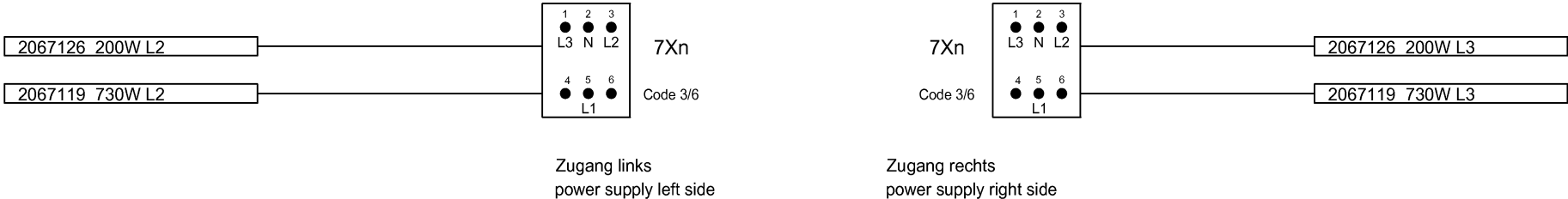

Verbreiterungsteil (VB) 0,8m V für 13.AB

P ges V=1,46kW

Glätter

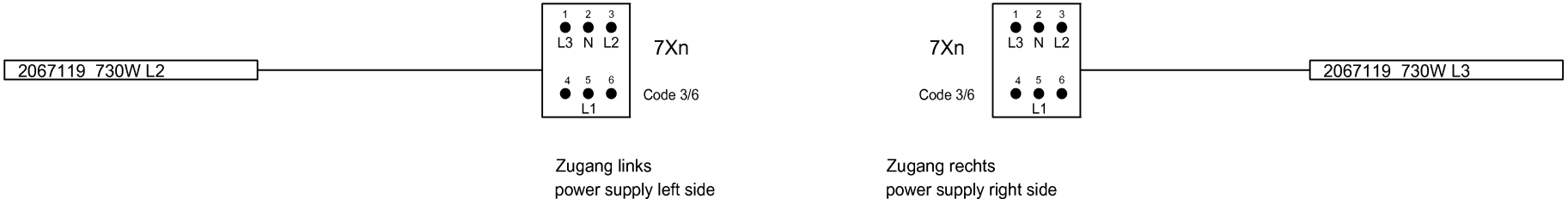

Schutzvermerk nach ISO 16016 beachten / Refer to protection notice ISO 16016

2014248

| | | | | | | |
|------------------|--|-------------------|------------------------------------------------------------------------------------------------------|----------------------------------|---------------------------------------------------------------|----------|
| a b c d | | 10.05.10 Heindtel |  Joseph Vögele AG | Bohlenheizung 13.AB 0001-XXXX | 2048159 02 Heizung VB0,80m (T)V heating system VB 0,80m | 12 13 |
|------------------|--|-------------------|------------------------------------------------------------------------------------------------------|----------------------------------|---------------------------------------------------------------|----------|

Festlegungen

Anschluß Drehstromleitungen:

L1 = schwarz

L2 = grau

L3 = braun

N = blau

PE = grün/gelb

commitment

wire-connection:

L1 = black

L2 = grey

L3 = brown

N = blue

PE = green/yellow

Schutzvermerk nach ISO 16016 beachten / Refer to protection notice ISO 16016

| | | | | | | |
|------------------|--|-------------------|------------------------------------------------------------------------------------------------------|----------------------------------|------------------------------------------|----------|
| a b c d | | 10.05.10 Heindtel |  Joseph Vögele AG | Bohlenheizung 13.AB 0001-XXXX | 2048159 02 Festlegungen commitment | 13 13 |
|------------------|--|-------------------|------------------------------------------------------------------------------------------------------|----------------------------------|------------------------------------------|----------|