



VÖGELE

Anschlussplan connection diagram

Super 1800-3 / 1800-3i

Vorläufige Version

14.82
Baureihe /
Series

0010 - XXXX
Seriennummer /
Serial No

24.10.2012
Ausgabedatum /
Date of issue

HAP_1482_2293890_00_00_00
Katalog Bestellnummer /
Catalogue order No

Schutzvermerk nach ISO 16016

Weitergabe sowie Vervielfältigung dieses Dokuments, Verwertung und Mitteilung seines Inhalts sind verboten, soweit nicht ausdrücklich gestattet.

Zu widerhandlungen verpflichten zum Schadenersatz. Alle Rechte für den Fall der Patent-, Gebrauchsmuster- oder Geschmacksmustereintragung vorbehalten.

Protection Notice ISO 16016

The reproduction, distribution and utilization of this document as well as the communication of its contents to others without explicit authorization is prohibited.

Offenders will be held liable for the payment of damages. All rights reserved in the event of the grant of a patent, utility model or design.

Hydraulics
Schutzvermerk nach ISO 16016 beachten
Refer to protection notice ISO 16016
© 2012 by Joseph Vögele AG

1 2 3 4 5 6 7 8

Blatt / Sheet	Inhalt / Contents	Blatt / Sheet	Inhalt / Contents
1	Deckblatt cover sheet		
2	Inhaltsverzeichnis contents		
3	14/ 16.AB - AB500-TV 14/ 16.AB - AB500-TV		
4	15/ 17.AB - AB500-TP1 15/ 17.AB - AB500-TP1		
5	15/ 17.AB - AB500-TP2 15/ 17.AB - AB500-TP2		
6	15/ 17.AB - AB500-TP2 mit HEE 15/ 17.AB - AB500-TP2 with HEE		
7	02/ 05.SB - SB250-TV 02/ 05.SB - SB250-TV		
8	02/ 05.SB - SB250-TV mit HEE 02/ 05.SB - SB250-TV with HEE		
9	02/ 05.SB - SB250-TP1 02/ 05.SB - SB250-TP1		
10	02/ 05.SB - SB250-TP1 mit HEE 02/ 05.SB - SB250-TP1 with HEE		
11	02.SB/ 05.SB - SB250-TVP2 02.SB/ 05.SB - SB250-TVP2		
12	02.SB/ 05.SB - SB250-TVP2 mit HEE 02.SB/ 05.SB - SB250-TVP2 with HEE		

Drawing by:		Approved by:		last change:		Status:		Material No.:		Document No.: Partial Document No.: Version No.:		Inhaltsverzeichnis contents Sheet: 2 of 12 Sheets
date	17.10.2012	date		date		AE =changable	2293890	Series code:	Valid for Serial No.:			
name	Keilmann	name		name		PF =prototype release	Revision No.:	14.82	from 0010 to	XXXX		
E - CAE		Document type:		Function group No.:		SF =serial release	00	Sheet plant:				
		HFP						Sheet Location:				

1 2 3 4 5 6 7 8

Hydraulics
Schutzvermerk nach ISO 16016 beachten
Refer to protection notice ISO 16016
© 2012 by Joseph Vögele AG

1 2 3 4 5 6 7 8

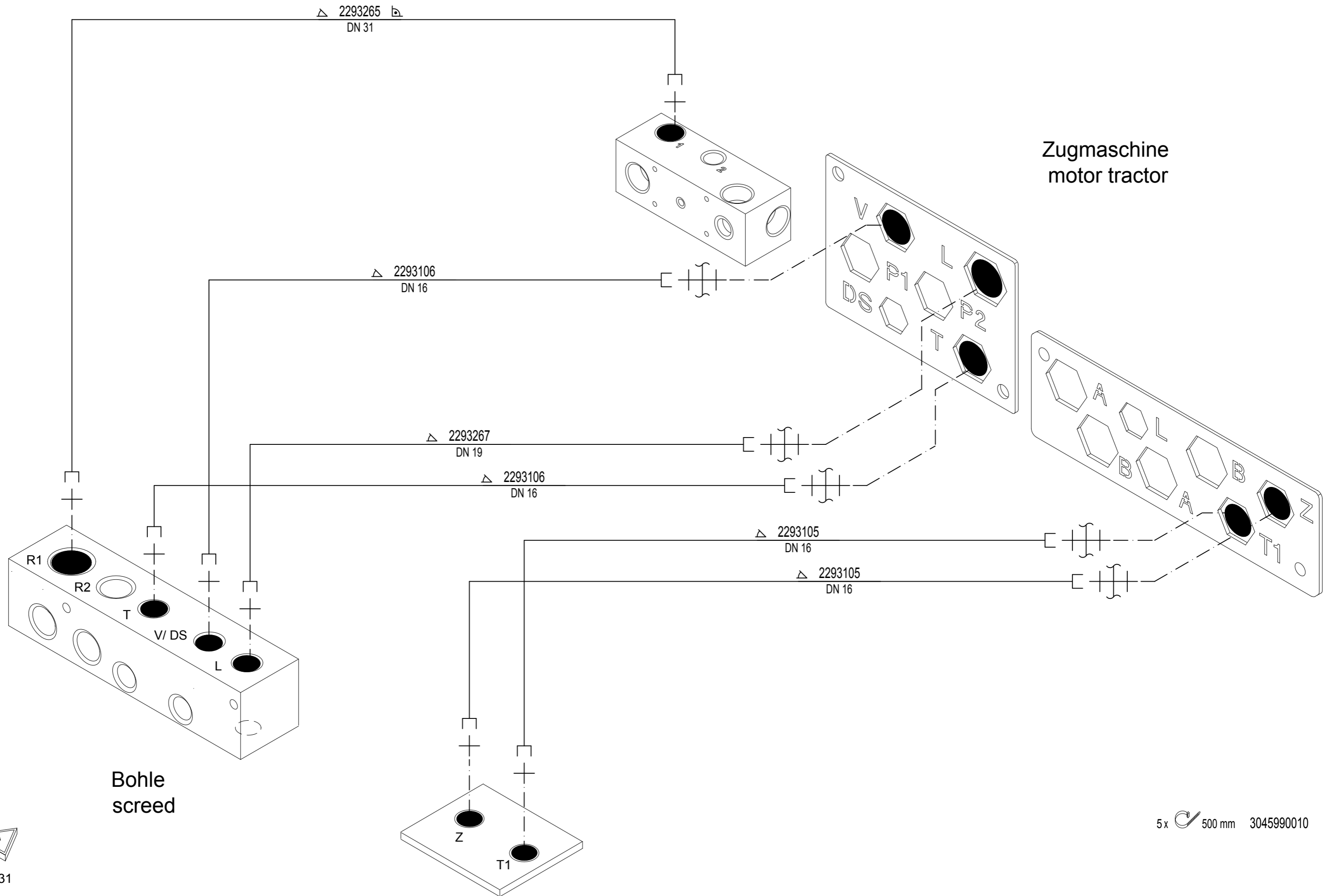

2292931

5x 500 mm 3045990010

Drawing by: date 17.10.2012 name Keilmann		Approved by: date name		last change: date name		Status: AE =changable PF =prototype release SF =serial release		Material No.: 2293890 Revision No.: 00		Document No.: Partial Document No.: Version No.: Series code: 14.82 Valid for Serial No.: from 0010 to XXXX Sheet plant: Sheet Location:		23/25AB - AB500-3/600-3 TV 23/25AB - AB500-3/600-3 TV		Sheet: 3 of 11 Sheets	
E - CAE		Document type: HAP		Function group No.:											

1 2 3 4 5 6 7 8

Hydraulics
Schutzvermerk nach ISO 16016 beachten
Refer to protection notice ISO 16016
© 2012 by Joseph Vögele AG

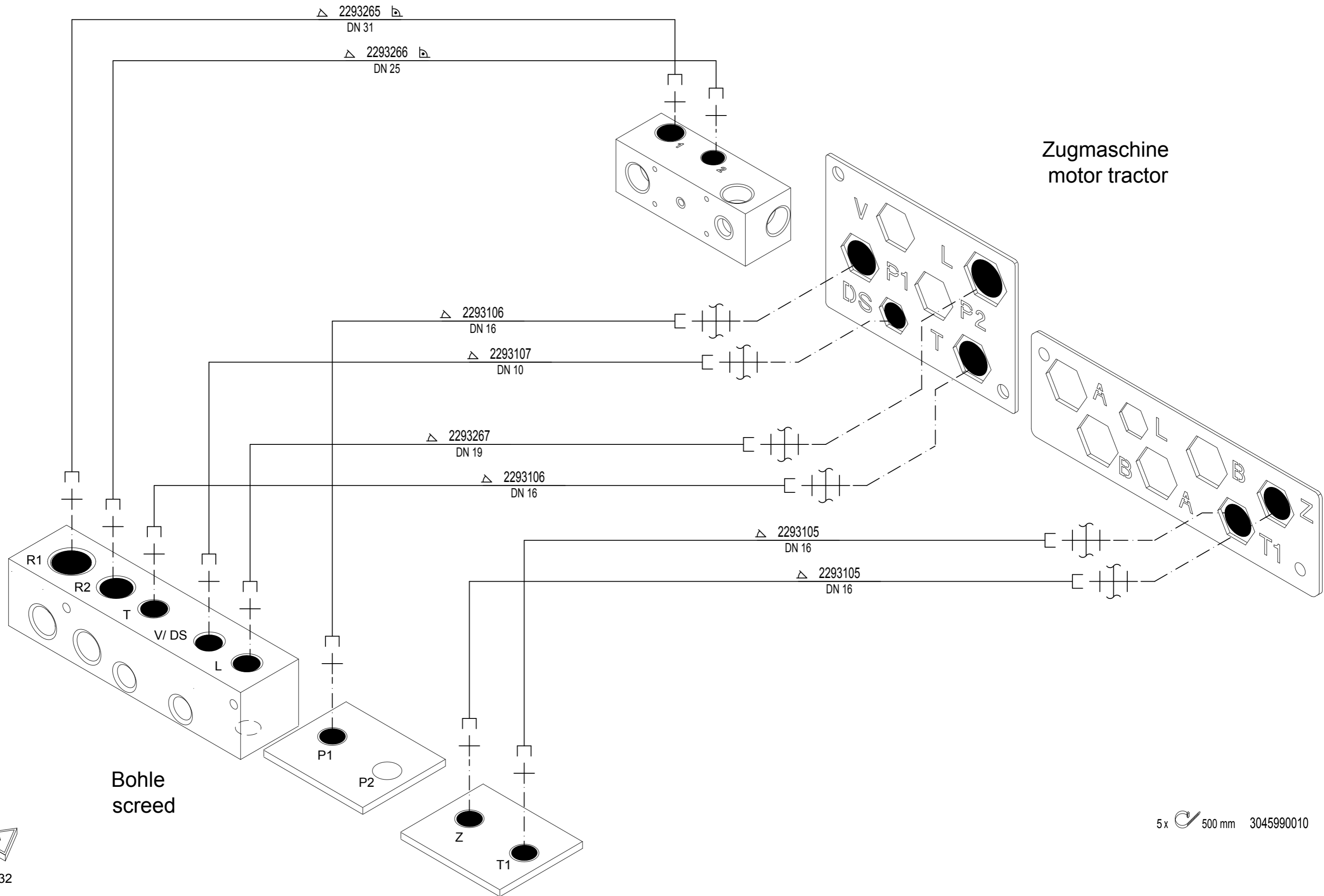

2292932

5x 500 mm 3045990010

Drawing by:		Approved by:		last change:		Status:		Material No.:		Document No.: Partial Document No.: Version No.:		24/26AB - AB500-3/600-3 TP1		Sheet: 4 of 11	
date 17.10.2012		date		date		AE =changable		2293890		Series code: 14.82		Valid for Serial No.: from 0010 to XXXX		24/26AB - AB500-3/600-3 TP1	
name Keilmann		name		name		PF =prototype release		Revision No.: 00		Sheet plant:					
E - CAE		Document type: HAP		Function group No.:		SF =serial release				Sheet Location:					

Hydraulics
Schutzvermerk nach ISO 16016 beachten
Refer to protection notice ISO 16016
© 2012 by Joseph Vögele AG

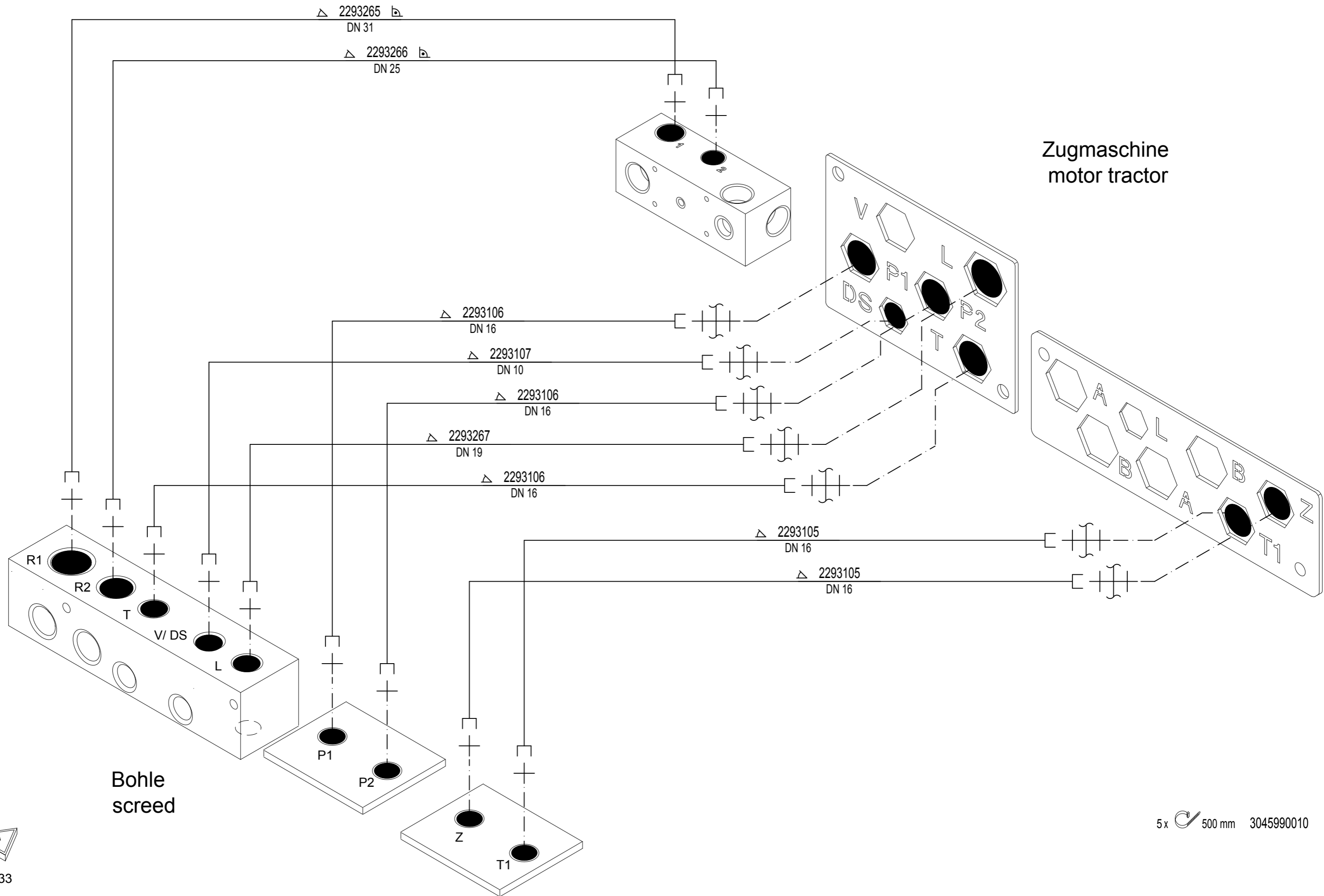

2292933

5x 500 mm 3045990010

Drawing by: date 17.10.2012 name Keilmann		Approved by: date name		last change: date name		Status: AE =changable PF =prototype release SF =serial release		Material No.: 2293890 Revision No.: 00		Document No.: Partial Document No.: Version No.:		Series code: 14.82 Valid for Serial No.: from 0010 to XXXX		Sheet plant: Sheet Location:		24/26AB - AB500-3/600-3 TP2 24/26AB - AB500-3/600-3 TP2		Sheet: 5 of 11 11 Sheets	
E - CAE		Document type: HAP		Function group No.:															

Hydraulics
Schutzvermerk nach ISO 16016 beachten
Refer to protection notice ISO 16016

1 2 3 4 5 6 7 8

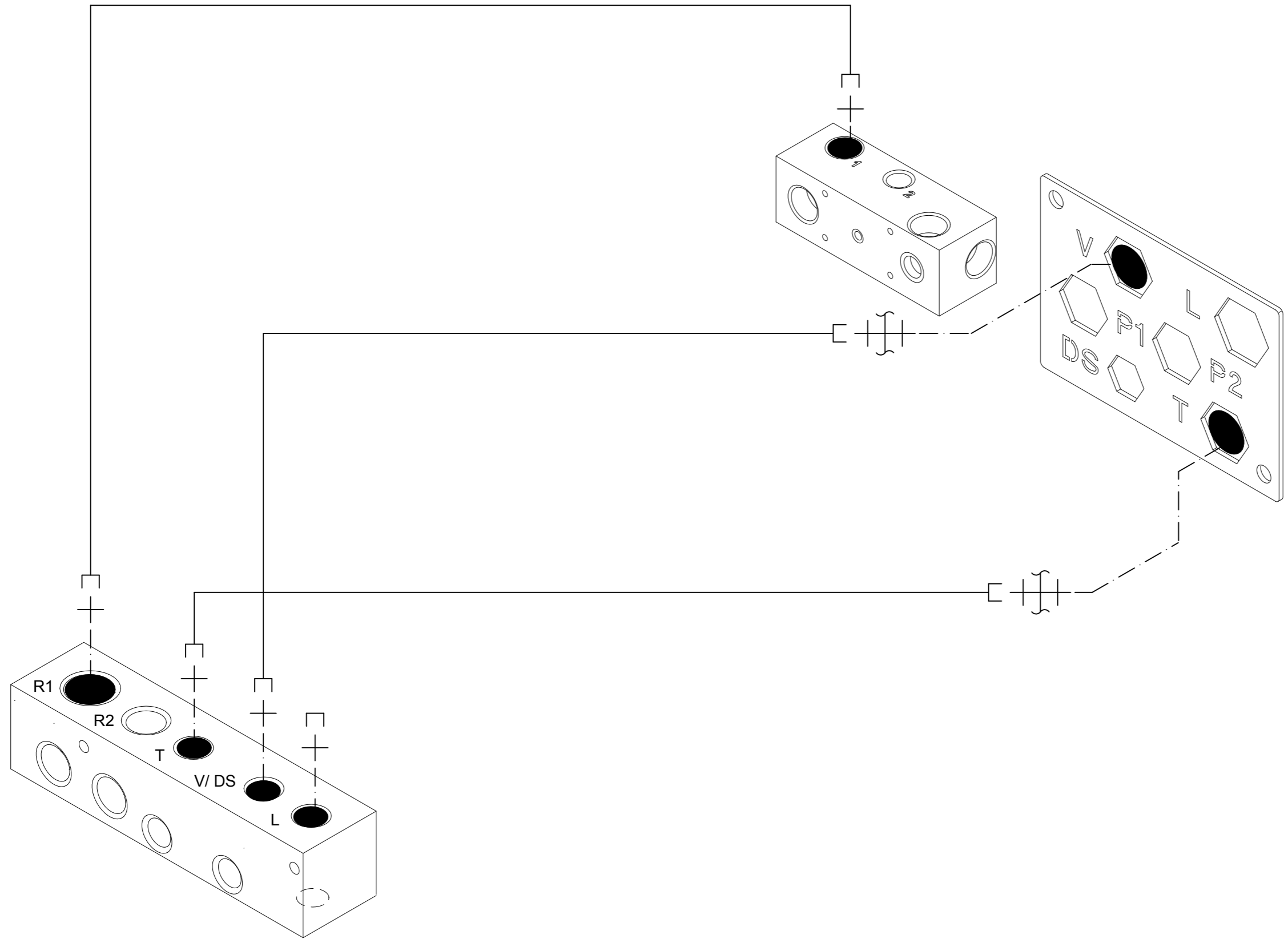

Zugmaschine
motor tractor

Bohle
screed



2292933

Drawing by:		Approved by:		last change:		Status:		Material No.:		Document No.: Partial Document No.: Version No.:		05SB - SB250-2 TV 05SB - SB250-2 TV		Sheet:			
date 17.10.2012		date		date		AE =changable		2293890		Series code: 14.82				Valid for Serial No.:		6	
name Keilmann		name		name		PF =prototype release		Revision No.: 00		from 0010 to XXXX				Sheet plant:		of	
E - CAE		Document type:		Function group No.:		SF =serial release		WIRTGEN GROUP		Sheet Location:		11		Sheets			
HAP								VÖGELE									

1 2 3 4 5 6 7 8

© 2012 by Joseph Vögele AG

Hydraulics
Schutzvermerk nach ISO 16016 beachten
Refer to protection notice ISO 16016
© 2012 by Joseph Vögele AG

1 2 3 4 5 6 7 8

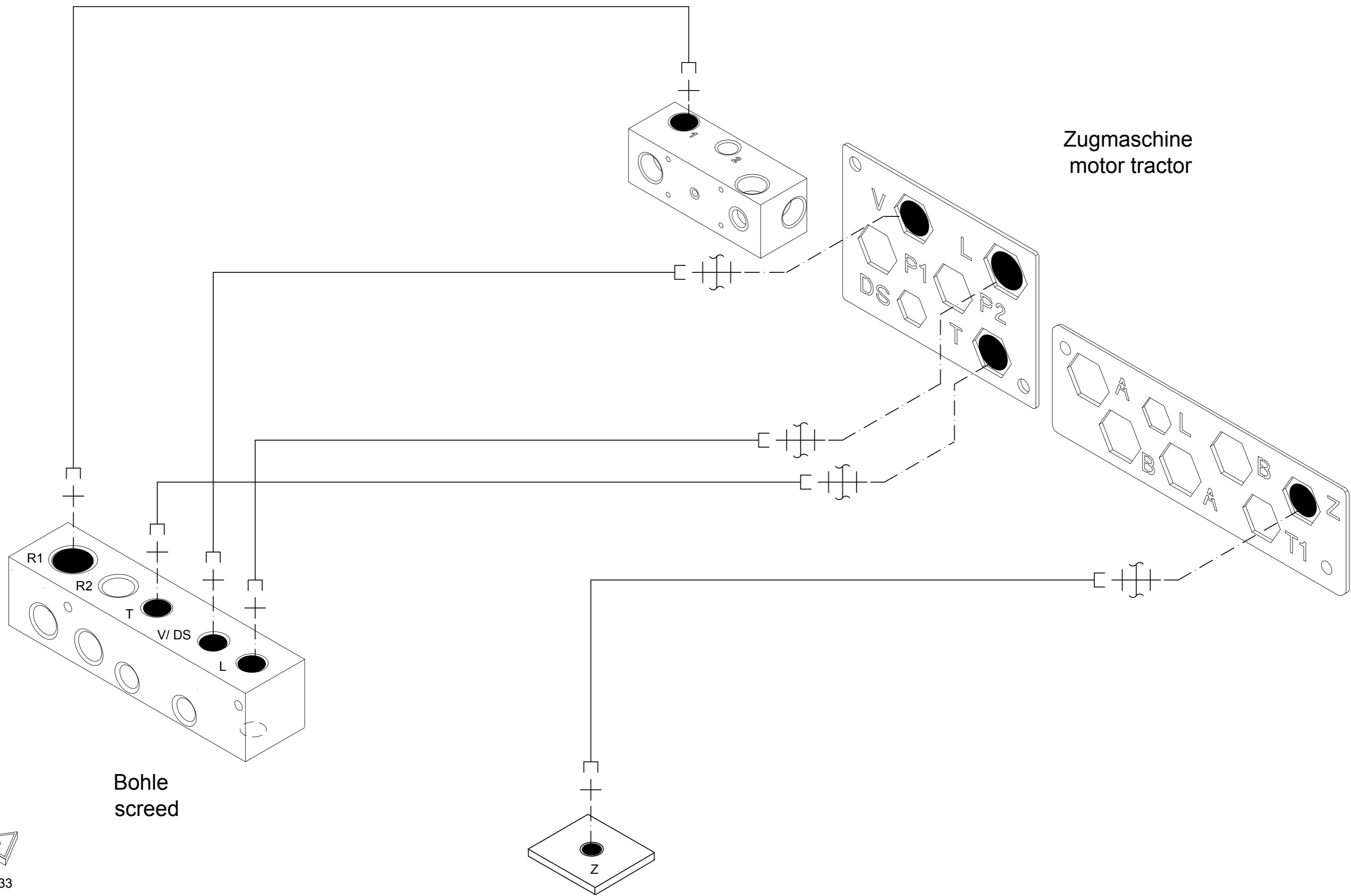

2292933

Drawing by:		Approved by:		last change:		Status:		Material No.:		Document No.: Partial Document No.: Version No.:		05SB - SB250-2 TV mit HEE 05SB - SB250-2 TV with HEE		Sheet:			
date 17.10.2012		date		date		AE =changable		2293890		Series code:				Valid for Serial No.:		7	
name Keilmann		name		name		PF =prototype release		Revision No.: 00		14.82				from 0010 to XXXX		of	
E - CAE		Document type:		Function group No.:		SF =serial release				Sheet plant:		<p style="text-align: center;">11</p> <p style="text-align: right;">Sheets</p>		11			
		HAP						Sheet Location:									

1 2 3 4 5 6 7 8

Hydraulics
Schutzvermerk nach ISO 16016 beachten
Refer to protection notice ISO 16016
© 2012 by Joseph Vögele AG

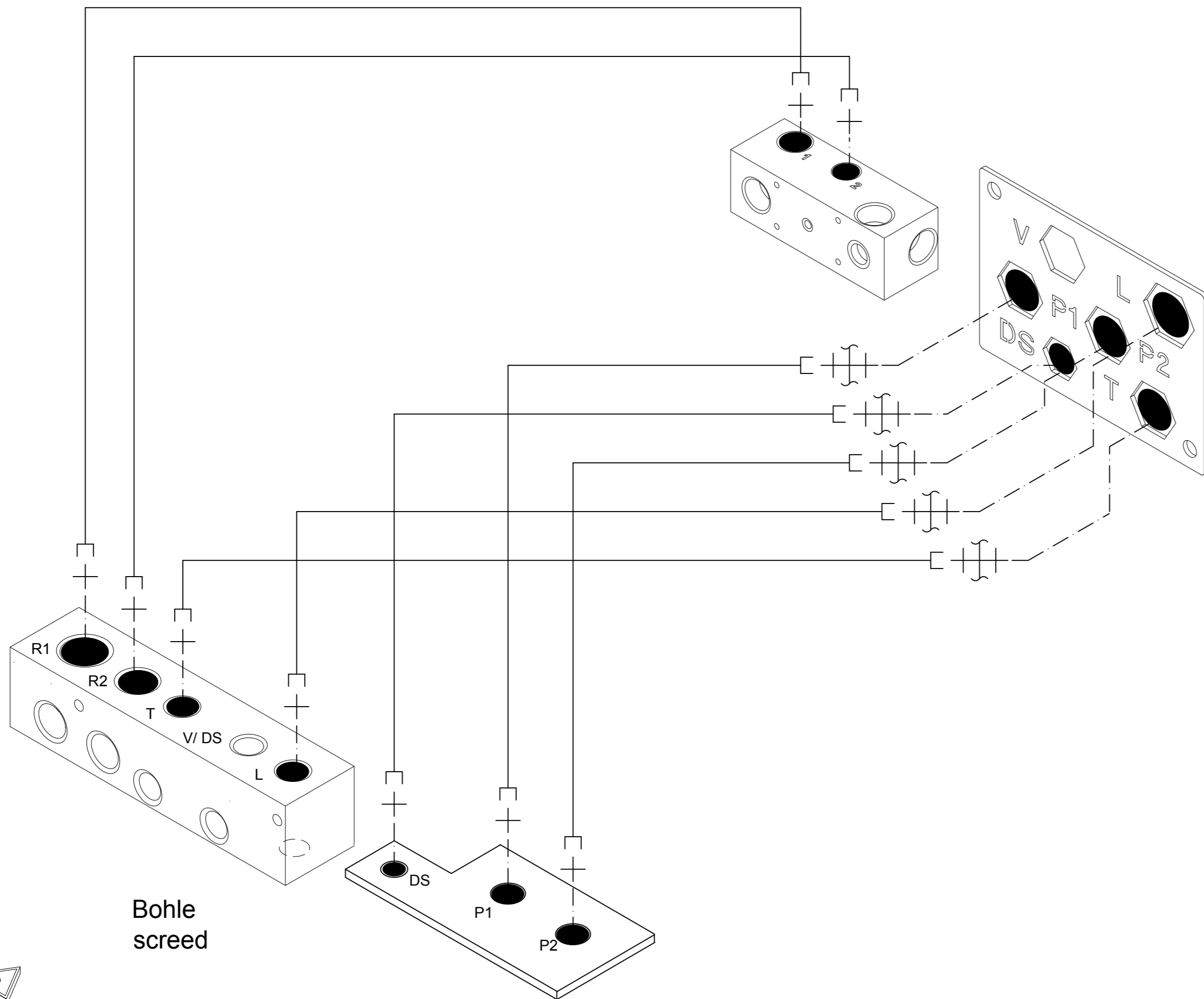

Zugmaschine
motor tractor

Bohle
screed



2292933

Drawing by:		Approved by:		last change:		Status:		Material No.:		Document No.: Partial Document No.: Version No.:		05SB - SB250-2 TP 05SB - SB250-2 TP		Sheet:			
date 17.10.2012		date		date		AE =changable		2293890		Series code: 14.82				Valid for Serial No.:		8	
name Keilmann		name		name		PF =prototype release		Revision No.: 00		from 0010 to XXXX				Sheet plant:		of	
E - CAE		Document type:		Function group No.:		SF =serial release				Sheet Location:		11		Sheets			
1		2		3		4		5		6		7		8			

Hydraulics
Schutzvermerk nach ISO 16016 beachten
Refer to protection notice ISO 16016

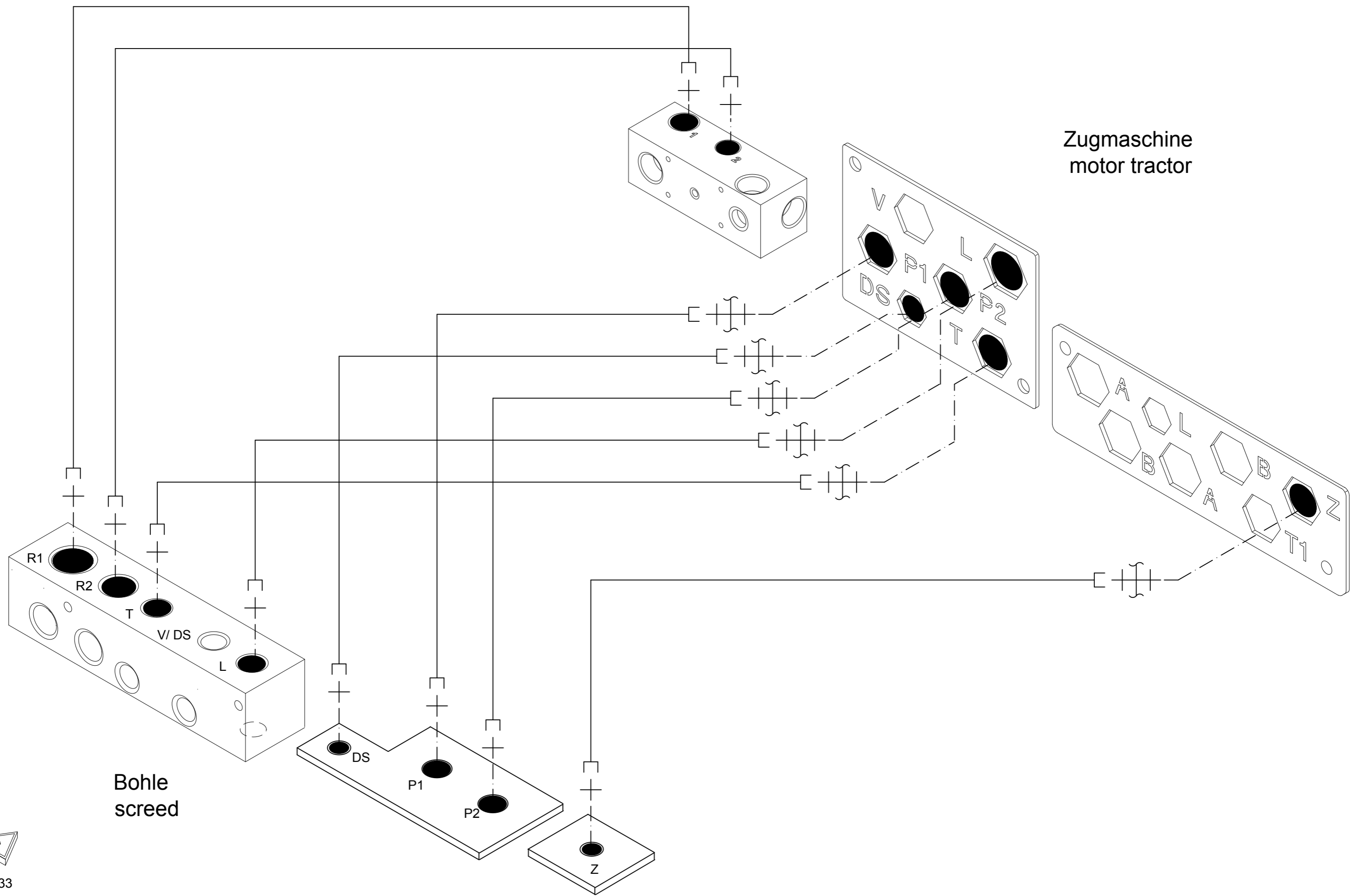

2292933

Drawing by:		Approved by:		last change:		Status:		Material No.:		Document No.: Partial Document No.: Version No.:		05SB - SB250-2 TP mit HEE 05SB - SB250-2 TP with HEE		Sheet: 9 of 11	
date 17.10.2012		date		date		AE =changable PF =prototype release SF =serial release		2293890		Series code: 14.82		Valid for Serial No.: from 0010 to XXXX		Sheet plant: Sheet Location:	
name Keilmann		name		name				Revision No.: 00							
E - CAE		Document type: HAP		Function group No.:											

© 2012 by Joseph Vögele AG

Hydraulics
Schutzvermerk nach ISO 16016 beachten
Refer to protection notice ISO 16016

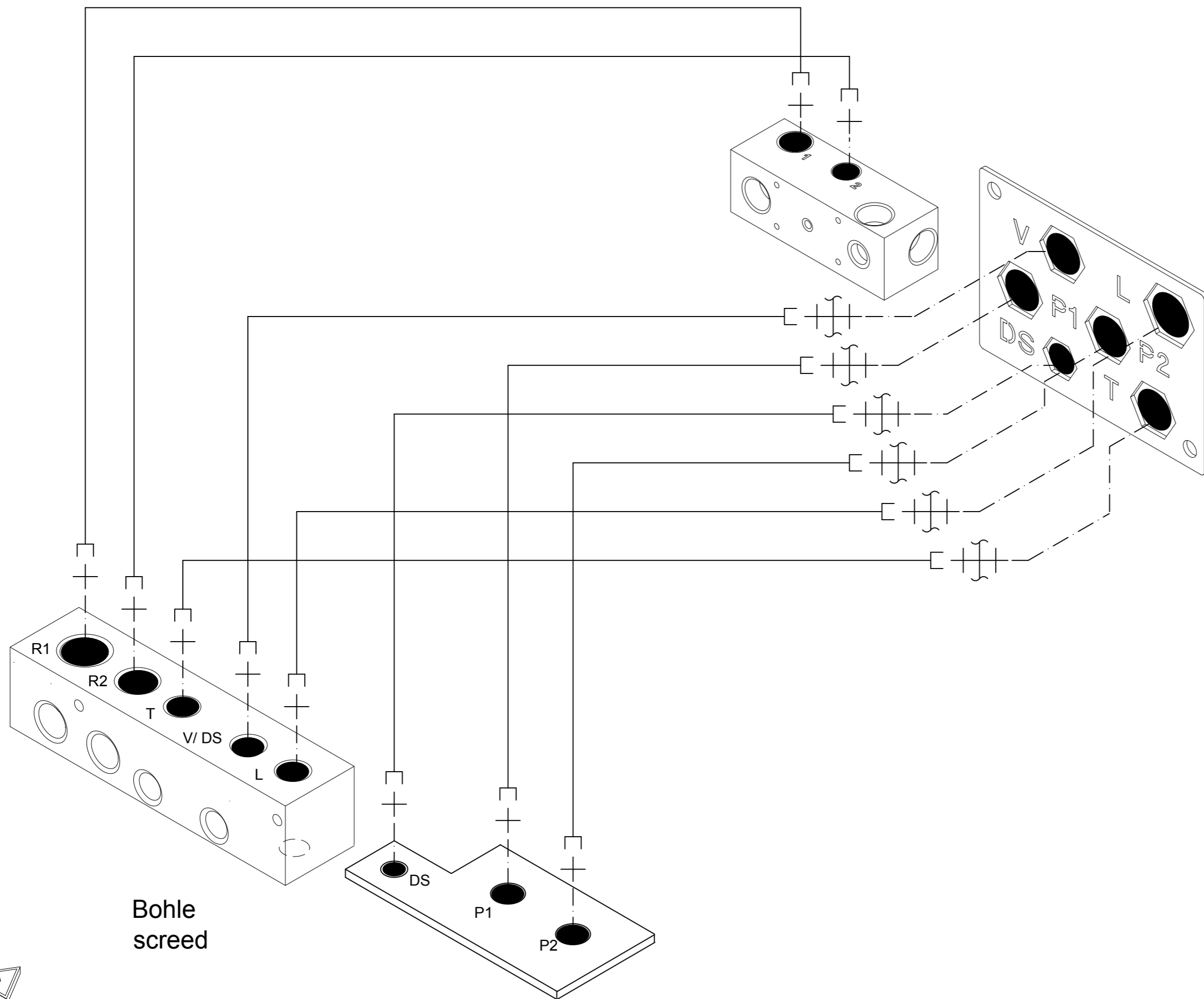

2292933

Drawing by:		Approved by:		last change:	
date	17.10.2012	date		date	
name	Keilmann	name		name	
E - CAE		Document type:		Function group No.:	
		HAP			

Status:
 AE =changable
 PF =prototype release
 SF =serial release

Material No.:
2293890
 Revision No.:
00



Document No.:		Partial Document No.:		Version No.:	
Series code:	14.82	Valid for Serial No.:	from 0010 to XXXX		
Sheet plant:		Sheet Location:			

05SB - SB250-2 TVP
 05SB - SB250-2 TVP

Sheet:
of **10**
of **11** Sheets

© 2012 by Joseph Vögele AG

Hydraulics
Schutzvermerk nach ISO 16016 beachten
Refer to protection notice ISO 16016
© 2012 by Joseph Vögele AG

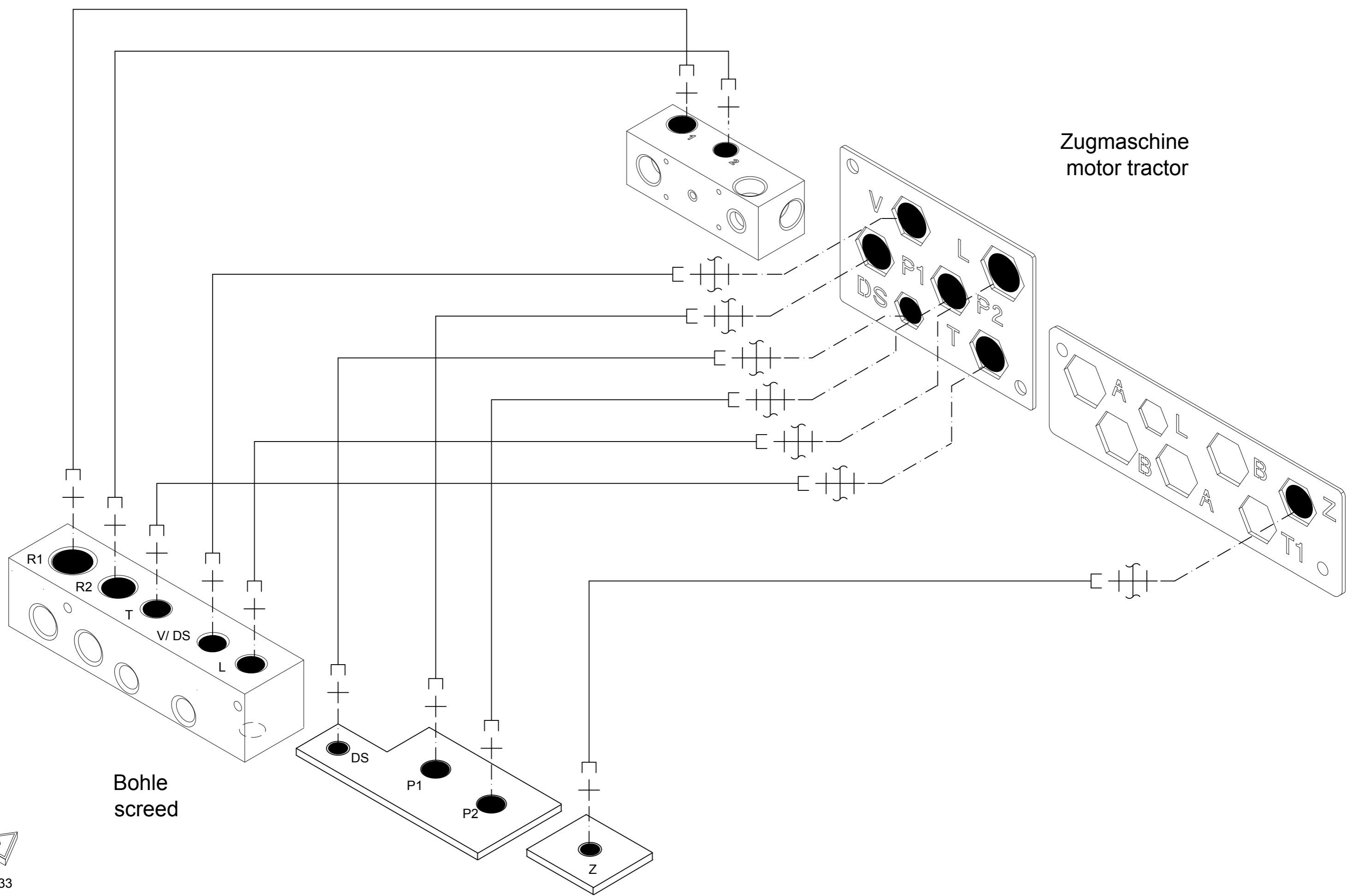

2292933

Drawing by:		Approved by:		last change:	
date	17.10.2012	date		date	
name	Keilmann	name		name	
E - CAE		Document type:		Function group No.:	
		HAP			

Status:
 AE =changable
 PF =prototype release
 SF =serial release

Material No.:
2293890
 Revision No.:
00



Document No.:		Partial Document No.:		Version No.:	
Series code:	14.82	Valid for Serial No.:	from 0010 to	XXXX	
Sheet plant:		Sheet Location:			

05SB - SB250-2 TVP mit HEE
 05SB - SB250-2 TVP with HEE

Sheet:
11
of
11
Sheets