



Panegossi

Uma empresa genuinamente brasileira



Acesse nosso site com este QR Code.

Catálogo
de produtos
2012

Agrícola • Industrial • Canavieira • Automotiva

- A Panegossi tornou-se fornecedora de confiabilidade para as montadoras mais renomadas, com conceito de padrão em excelência da sua diversificada linha de produtos na qual se destacam pino e bucha, manga de eixo e parte da articulação de tratores.
- A Panegossi é pioneira no processo de tratamento térmico em embuchamento de aço por indução eletrônica, mais uma tecnologia agregada ao processo produtivo.
- A Panegossi investe constantemente em pesquisas de novas tecnologias e aprimoramento de novos produtos num setor de engenharia ágil e altamente qualificado. É um dos maiores ativos que a Panegossi oferece ao setor que atua, cuja preocupação constante é o atendimento pontual e o controle de qualidade, acumulando uma relação de custo-benefício diferenciada.
- E com estes predicados a Panegossi é fornecedora fundamental dos mais importantes atacadistas de peças e fabricantes de máquinas no mercado interno e externo.

A Panegossi é referência de qualidade: o principal conceito de sua marca.

PROCEDIMENTO PARA ENVIO DE PRODUTOS PARA ANÁLISE DE GARANTIA

- De acordo com a nossa política de atendimento ao cliente e a busca pela melhoria contínua dos nossos processos e prestação de serviços, temos que informar aos nossos clientes que diversos fatores poderão comprometer a performance do produto na sua aplicação.

FATORES COMO:

- Utilização dos nossos produtos em conjunto com outros de qualidade inferior, comprometendo a performance do produto num todo;
- Aplicação incorreta do produto;
- Falta de lubrificação no período recomendado pelos fabricantes;
- Erro na forma de acondicionamento no estoque;
- Comprometimento de outros produtos agregados na aplicação;
- Execução de retrabalhos sem acompanhamento técnico;
- Modificação das características originais.

ANÁLISE DE GARANTIA:

- Terão direito a garantia todas as solicitações enviadas no período de até 03 meses da data de emissão da nota fiscal;
- Não serão aceitos envio de garantia sem prévia consulta e posterior autorização de um dos nossos representantes;
- O cliente deverá informar no campo "Dados Adicionais" o número da nota fiscal, a data de emissão e o motivo da solicitação.



Panegossi

PANEGOSSI manufactures a wide variety of parts for use in agriculture and construction tractors, cane, harvesters, fork lifters and other industrial equipments. The most important products are pins, bushes, axis, tractor articulations which are supplied to many renowned assemblers and dealers in the Brazilian market as well as abroad.

PANEGOSSI is pioneer in steel bushing production with treatment by electronic induction, helping the assemblers in the process of nationalization of pieces and in the development of new products for machines and agricultural implements contributing directly to improvement of processes and costs.

PANEGOSSI constantly invests in technology to keep itself more and more competitive aspiring distinctively serve customers through great business, products and services.

Go for quality, the main concept of Panegossi's brand.

Panegossi Actua en la fabricación de Componentes para Tractores y Máquinas de las siguientes líneas;

• Agrícolas • Cañeras • Industrial • Transporte

Panegossi se transformó en una proveedora confiable para las montadoras más renombradas, con un concepto padrón en excelencia de su diversificada línea de productos, en la cual se destacan pernos y bujes, manga de eje y partes de la articulación de tractores.

Panegossi es pionera en el proceso de tratamiento térmico en embujado de acero por inducción electrónica, una tecnología más, agregada al proceso productivo.

Panegossi invierte constantemente en investigaciones de nuevas tecnologías y perfeccionamiento de nuevos productos en un sector de ingeniería ágil y altamente calificado. Es uno de los mayores activos que Panegossi ofrece al sector que actúa, cuya preocupación constante es la atención puntual y el control de calidad, acumulando una relación de costo-beneficio diferenciada.

Y con estos principios, es provedora fundamental de los más importantes distribuidores de partes y fabricantes de máquinas en el mercado doméstico y externo.

PANEGOSSI es referencia de calidad;
el principal concepto de su marca.



Panegossi

Por quê usar Grupo de Pinos e Buchas Panegossi?

Why using Panegossi's Group of Pins and Bushing?

Por que usar Grupo de Pinos y Bujes Panegossi?



Nossos Pinos e Buchas são os ÚNICOS de 3,0 a 4,0 mm de Camada de Dureza

Our pins and bushing are the only ones in the market with 3,0 to 4,0 mm hardness layer.

Nuestros pinos y bujes son los UNICOS de 3.0 a 4.0 mm de camada de dureza



Enquanto os Pinos e Buchas disponíveis no mercado são de 1,8 a 2,2 mm de Camada de Dureza

Other pins and bushing brands in the market have 1,8 to 2,2 mm hardness layer.

Mientras los pinos y bujes disponibles en el mercado son de 1.8 a 2.2 mm de camada de dureza

Com os grupos Panegossi você terá em média **20%** a mais de horas trabalhadas, em comparação aos outros produtos disponíveis no mercado. Isso devido ao nosso Tratamento Térmico por Indução Eletrônica, oferecendo ao cliente maior durabilidade em suas peças. Garantindo assim, ótimo custo-benefício.

With Panegossi's parts you will be able to work 20% more hours than other brands. This is due out thermal treatment by electronic induction that offers our customers a larger durability for their parts guaranteeing a great cost-benefit.

Con las piezas Panegossi, Ud. podrá trabajar 20% a más, em comparación a otros productos disponibles en el mercado. Todo esto debido a nuestro Tratamiento Térmico por Inducción Electrónica. Ofreciendo al cliente una mayor durabilidad en sus piezas. Garantizado así, un óptimo costo-beneficio.

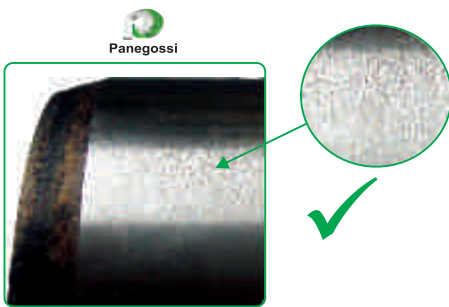

Nossos Pinos e Buchas são os ÚNICOS com Retífica

All Panegossi's Pin and Bushing are Rectified

Nuestros Pinos y Bujes son los únicos con Rectifica

• Benefícios

Benefits
Beneficios

- ✓ Menor Atrito na Montagem;
*Lower attrition in the assembly;
Menor atrito en el Montaje;*
- ✓ Menor perda de Material no Olhal do Link;
*Less material loss in the link eye;
Menor pérdida de Material en el Link;*
- ✓ Menor Rugosidade;
*Less furrow (lines);
Menor Rugosidad;*
- ✓ Superfície com Dimensional Exigido.
*Surface with demanded dimensional;
Superficie con las Dimensiones exigidas;*

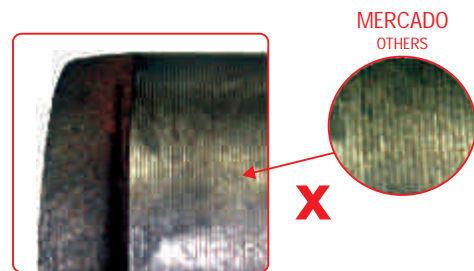

Enquanto os Pinos e Buchas disponíveis no mercado são somente usinados

The groups available in the Market are machined only
Mientras los Pinos y Bujes disponible en el mercado son solo mecanizados

- Danos
*Damages
Daños*
- x Maior Atrito na Montagem;
*Higher attrition in the assembly;
Mayor atrito en el Montaje;*
- x Maior Perda de Material no Olhal do Link;
*More material loss in the link eye;
Mayor pérdida de Material en el Link;*
- x Maior Rugosidade;
*More furrow (lines);
Mayor rugosidad;*
- x Superfície com Dimensional Padrão.
*Surface with dimensional standard;
Superficies con dimensiones padrón;*

A Panegossi, produz peças com medidas especiais com a mesma Qualidade e Eficiência garantidas as grandes montadoras.

Panegossi manufactures parts with special measures with the same quality and efficiency guaranteed by the great assemblers.

Panegossi produce piezas con medidas especiales con la misma Calidad y Eficiencia garantizadas a las grandes montadoras.

Nossos Grupos de Pinos e Buchas atendem as majorações de acordo com a necessidade do Cliente

Our pins and bushing groups meet the mark up according to customer's needs.

Nuestros Grupos de Pinos y Bujes atienden a las medidas de acuerdo con la necesidad del Cliente.

As peças disponíveis no mercado, são peças de medidas padrões. O Grupo de Pino e Bucha que não atende a majoração desejada, faz com que o cliente acabe diminuindo a vida útil de sua Esteira.

The available parts/pieces in the market have standard measures. Those groups that do not meet the desired mark-up can reduce substantially the useful life of the equipment.

Las Piezas disponibles, son piezas de medidas padrón. El grupo de Pino y Buje que no atiende a las medidas deseadas, ocasiona una disminución de la vida útil de la Oruga.



Abaixo, segue exemplo da montagem correta do Grupo:

Here follows an example of correct assembly of the group:

Sigue un ejemplo para el correcto montaje del grupo;



Conjunto de 3 itens (06 peças)
Set of 3 items (06 parts)
Conjunto de 3 itens (6 piezas)



Pino e Bucha ao lado das Arruelas de Vedação
Pins and bushing beside the washers
Pino y Buje al lado de las Arandelas de Fijación



Por outro ângulo as
Arruelas deverão ficar assim:



Inserir as Arruelas, uma de frente para outra. De forma que, uma protegerá a Bucha e a outra o Link.

Insert the washers one in front of the other. So that one will protect the bushing and the other the link.

Inserir las Arandelas, una de frente para la otra, de forma que una protegerá el buje y la otra el LINK



Pino e Bucha montado com as Arruelas de Vedação.

Pin and bushing set up with washers.

Pino y Buje montado con las Arandelas de Fijación.

De acordo com análise, a folga deixada em nossos Grupos de Pinos e Buchas são de 0,45 mm contra 1,0 mm das demais peças disponíveis no mercado. Fazendo com que nossos grupos façam com que sua Esteira tenha menos desgaste, menos impacto e possibilitando que a mesma não seja constantemente esticada, diminuindo o aumento de majorações.

According to the analysis the gap left in our groups of pins and bushing is 0,45mm against 1,00mm of other parts available in the market. So, our products provide to your equipment less wear on and less impact preventing it from being constantly stretched out, reducing the mark-up increase.

De acuerdo con el análisis, el huelgo dejado en nuestros Grupos de Pinos y Bujes son de 0,45 mm contra 1.0 mm de las demás piezas disponibles en el mercado. Como consecuencia, nuestros grupos garantizan que su Oruga tenga menos desgaste, menos impacto y evitando que sea constantemente estirada, alterando sus dimensiones.

Fazendo uma pequena análise de como é benéfico comprar Grupos com as majorações corretas, vemos que:

Briefly explaining how beneficial is buying groups with the correct mark-up:

Haciendo un pequeño análisis de como es benéfico comprar Grupos con dimensiones correctas, vemos que:

✓ **Panegossi - 39 Elos x 0,45 mm = 17,5 mm**

LINKS / ESLABONES

x **Peças do Mercado - 39 Elos x 1,0 mm = 39,0 mm**

OTHERS / PIEZAS DEL MERCADO

LINKS / ESLABONES



- ✓ Baixo desgaste entre os Elos;
Less wear on links;
Bajo desgaste entre los Eslabones;
- ✓ Maior vida útil do Equipamento;
Longer useful life of the equipment;
Mayor vida útil del Equipo;
- ✓ Ótimo custo-benefício.
Great cost benefits
Ótimo custo-benefício.





LINHA AGRÍCOLA
LAGRICULTURAL/AGRÍCOLA

ÍNDICE

AGRALE

08 a 09

JOHN DEERE

13 a 14

CARRARO

09

MASSEY FERGUSON

15 a 18

CASE

10

TRAMONTINI

18

CATERPILLAR

10

URSUS

18

CBT

11

VALTRA / VALMET

19 a 22

FORD / NEW HOLLAND

11 a 12

ZF

23 a 24

HUBER WARCO

13



Panegossi



**CONJUNTO
CARÇAÇA DE ARTICULAÇÃO**

Carcaças

8009103482009 LD

8009103483007 LE

Pinos Pivô

8009103262005

Porca Ranhurada

8009103374008

O Conjunto de Carcaça Montada acompanha:

QTD.	DESCRIÇÃO
01	Carcaça de Articulação
01	Porca Ranhurada
02	Pinos Pivô
06	Parafusos Sextavados

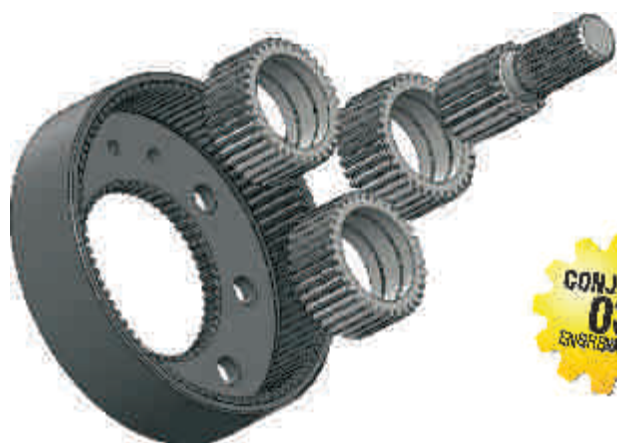

**CONJUNTO DE ENGRENAGENS
PORTADOR PLANETÁRIA**

Engrenagem Dente Interno

8009103301001

Engrenagem

8009103304005

Eixo Solar

8009103302009

O Conjunto de Engrenagens acompanha:

QTD.	DESCRIÇÃO
01	Engrenagem de Dente Interno
01	Eixo Solar
03	Engrenagens

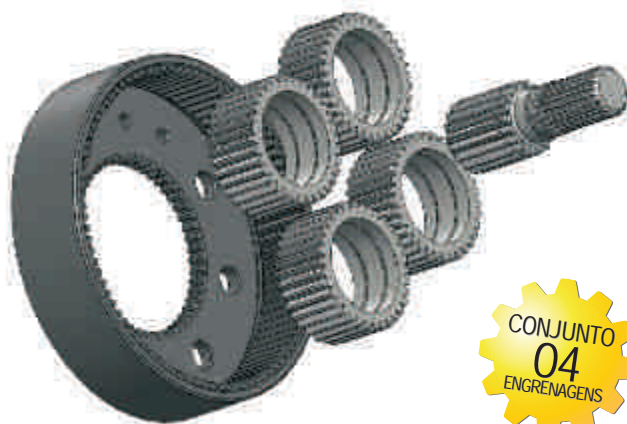

**CONJUNTO DE ENGRENAGENS
PORTADOR PLANETÁRIA**

Engrenagem Dente Interno

8009103301001

Engrenagem

8009103304005

Eixo Solar

8009103302009

O Conjunto de Engrenagens acompanha:

QTD.	DESCRIÇÃO
01	Engrenagem de Dente Interno
01	Eixo Solar
04	Engrenagens

*Imagens meramente ilustrativas.



8009103483007 LE
APL 345, 350 / AS 3050



8009103482009 LD
APL 345, 350 - AS 3050



8009103399005
APL 335, 340, 345 / AS 3035
(03 Engrenagens / 03 Gear / 03 Engranajes)



8009103303007
APL 350 / AS 3050
(04 Engrenagens / 04 Gear / 04 Engranajes)



8009103301001
APL 335, 340, 345, 350 / AS 3035, 3050



8009103302009
APL 345, 350 / AS 3050



8009103304005
APL 335, 340, 345, 350 / AS 3035, 3050



8009103262005
APL 345, 350 / AS 3050



8009103374008
APL 340, 345, 350 / AS 3035, 3050



8013103051004



8009103132000



CR101565



CR123475



CR123495



CR125149/1



CR126630



CR126631



CR128629/1



CR128881



CR128904



CR138560

*Imagens meramente ilustrativas.

CASE

 100520A1	 100522A1	 100553A1	 100553A1/C	 100561A1
			 100553A1/P	
 100562A1 - Dianteiro 580L	 116427A1	 122264A1	 122265A1	 144455A1 - Lado Esquerdo
 144456A1 - Lado Direito	 144466A1	 175977A1/P	 175979A1 - Traseiro 580L	 358286A1
 367184A1/P	 A12901	 A12905	 A18246/1	 A18258
 D50075	 D50081	 D50084	 E95677	

CATERPILLAR

*Imagens meramente ilustrativas.

 Ponta de Eixo - 2D4215 LD	 Ponta de Eixo - 2D4216 LE
--	---



070.0901.001 LD	070.0901.002 LE
100.0901.001 LD	100.0901.002 LE
210.0901.001 LD	210.0901.002 LE
251.0901.001 LD	251.0901.002 LE
310.0901.001 LD	310.0901.002 LE



1K713G



1KR720



CBT P



CBT M



CBT G



0610204006



102818 3/4 102818 7/8



CB102479

FORD / NEW HOLLAND

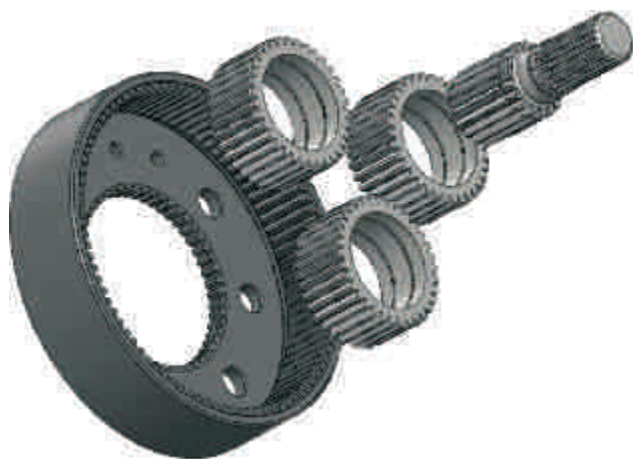

CONJUNTO DE ENGRENAGENS
PORTADOR PLANETÁRIA

Engrenagem Dente Interno

9579270
RZP4472352168

Engrenagem

9579254
RZP4472352014

Eixo Solar

9579263
RZP4472352074



O Conjunto de Engrenagens acompanha:

QTD.	DESCRIÇÃO
01	Engrenagem de Dente Interno
01	Eixo Solar
03	Engrenagens

*Imagens meramente ilustrativas.

FORD / NEW HOLLAND

 9579270	 9579254	 9579263	 9579264 • APL 350 / AS 3050 (04 Engrenagens / 04 Gear / 04 Engranajes)	 9579265
 84996852	 84996853	 9579221	 RZP4472352168	 RZP4472352014
 RZP4472352074	 RZP4472352103 • APL 335 (03 Engrenagens / 03 Gear / 03 Engranajes)	 RZP4472352162	 3107GA	 3108FA LE
 3107EA LD 3107FA LD 3108DA LE 3108EA LE 9575634 9575635	 449792 LE Aplicação 8040 / TC57	 449793 LD Aplicação 8040 / TC57	 5173281 LE	
 5173285 LD	 3126A 159A 159AA	 160A	 393710	 3NN544AB
 D9NN544AA	 C5NNN777A (15 DENTES) (15 TEETH) (15 DIENTES) E1NNN777AB (20 DENTES) (20 TEETH) (20 DIENTES)	 C5NN7A684A1 (15 DENTES) (15 TEETH) (15 DIENTES) E4NN7A684AA (20 DENTES) (20 TEETH) (20 DIENTES)	 C5NN3N703	 84997975 LD Aplicação TC59 / TC5090
 84997976 LE Aplicação TC59 / TC5090	 825949 5630 - 6630 - 7630 - 7830			

*Imagens meramente ilustrativas.



HUBER WARCO



6200150

JOHN DEERE

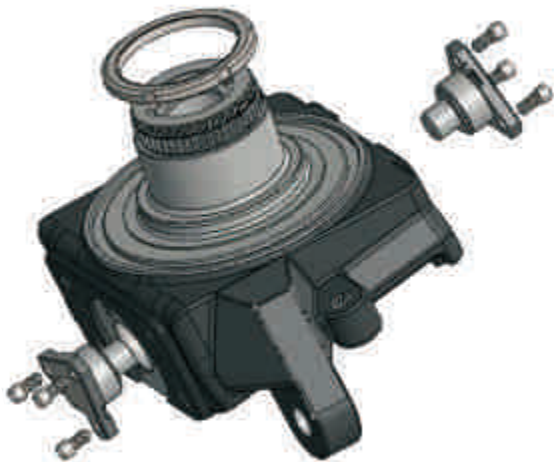

CONJUNTO CARÇA DE ARTICULAÇÃO

Carcças

CQ27249 LE
CQ27248 LD
CQ36984 LE
CQ36985 LD

Pinos Pivô

CQ27251 • CQ27343

Porca Ranhurada

T116822 • CQ27377

O Conjunto de Carça Montada acompanha:

QTD.	DESCRIÇÃO
01	Carça de Articulação
01	Porca Ranhurada
02	Pinos Pivô
06	Parafusos Sextavados

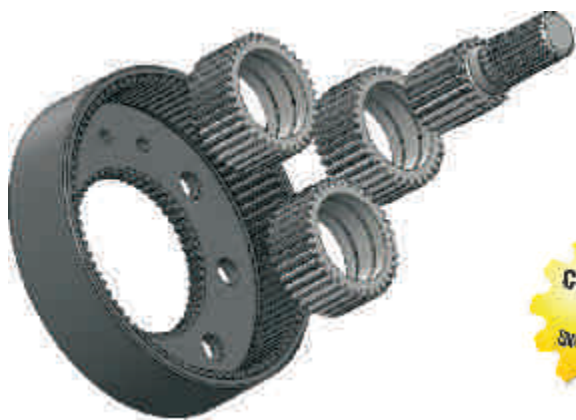

CONJUNTO DE ENGRENAGENS PORTADOR PLANETÁRIA

Engrenagem Dente Interno

CQ27301
CQ27381

Engrenagem

CQ29408
CQ27408

Eixo Solar
CQ27302 / CQ27861

O Conjunto de Engrenagens acompanha:

QTD.	DESCRIÇÃO
01	Engrenagem de Dente Interno
01	Eixo Solar
03	Engrenagens

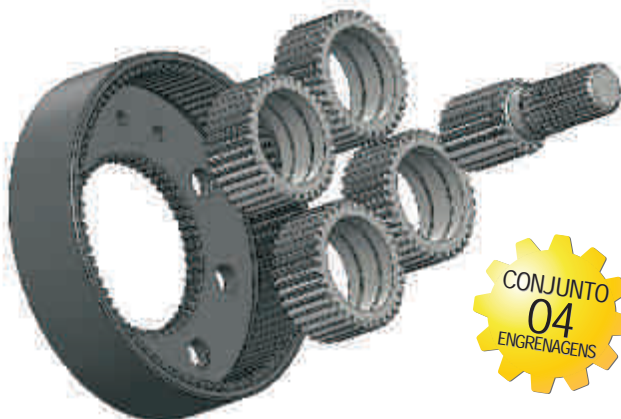

CONJUNTO DE ENGRENAGENS PORTADOR PLANETÁRIA

Engrenagem Dente Interno

CQ27301
CQ27381

Engrenagem

CQ29408
CQ27408

Eixo Solar
CQ27302 / CQ27861

O Conjunto de Engrenagens acompanha:

QTD.	DESCRIÇÃO
01	Engrenagem de Dente Interno
01	Eixo Solar
04	Engrenagens



*Imagens meramente ilustrativas.

JOHN DEERE



CQ27249 LE
APL 345, 350 / AS 3050

CQ36984 LE
APL 359



CQ27248 LD
APL 345, 350 - AS 3050

CQ36985 LD
APL 359



L41121 • APL 350 / AS 3050
(04 Engrenagens / 04 Gear / 04 Engranajes)



(03 Engrenagens / 03 Gear / 03 Engranajes)

L40012
APL 335, 340, 345 / AS 3035

CQ27407
APL 359



CQ27301
APL 335, 340, 345, 350 / AS 3035, 3050

CQ27381
APL 359



CQ29408
APL 335, 340, 345, 350 / AS 3035, 3050

CQ27408
APL 359



CQ27302
APL 345, 350 / AS 3050

CQ27861
APL 359



CQ27251



T116822
APL 335, 340, 345, 350 / AS 3035, 3050
CQ27377
APL 359



CQ29320



CQ29359



CQ27343



CQ10770



CQ10770 R



DQ66071 LD



DQ66072 LE

*Imagens meramente ilustrativas.



MASSEY FERGUSON



CONJUNTO CARÇAÇA DE ARTICULAÇÃO

Carcaças	Pinos Pivô
33554R1 LE	3176321M1
33555R1 LD	048307R1
048301R1 LE	Porca Ranhurada
048360R1 LD	3176334M1
	020794R1

O Conjunto de Carcaça Montada acompanha:

QTD.	DESCRIÇÃO
01	Carcaça de Articulação
01	Porca Ranhurada
02	Pinos Pivô
06	Parafusos Sextavados



CONJUNTO DE ENGRENAGENS PORTADOR PLANETÁRIA

Engrenagem Dente Interno	Engrenagem
3476335M1	3176340M1
020817R1	048348R1
	Eixo Solar
	3176336M1
	020818R1



O Conjunto de Engrenagens acompanha:

QTD.	DESCRIÇÃO
01	Engrenagem de Dente Interno
01	Eixo Solar
03	Engrenagens



CONJUNTO DE ENGRENAGENS PORTADOR PLANETÁRIA

Engrenagem Dente Interno	Engrenagem
3476335M1	3176340M1
020817R1	048348R1
	Eixo Solar
	3176336M1
	020818R1



O Conjunto de Engrenagens acompanha:

QTD.	DESCRIÇÃO
01	Engrenagem de Dente Interno
01	Eixo Solar
04	Engrenagens

*Imagens meramente ilustrativas.

MASSEY FERGUSON

 33554R1 LE APL 345, 350 / AS 3050 048301R1 LE APL 359	 33555R1 LD APL 345, 350 - AS 3050 048360R1 LD APL 359	 3176335M1 APL 335, 340, 345, 350 / AS 3035, 3050 020817R1 APL 359		
 3176339M1 APL 335, 340, 345 / AS 3035 048347R1 APL 359 (03 Engrenagens / 03 Gear / 03 Engranajes)	 3603350M1 APL 350 / AS 3050 (04 Engrenagens / 04 Gear / 04 Engranajes)	 3176336M1 APL 345, 350 / AS 3050 020818R1 APL 359	 3176340M1 APL 335, 340, 345, 350 / AS 3035, 3050 048348R1 APL 359	
 3176321M1 APL 345, 350 / AS 3050 048307R1 APL 359	 3176334M1 APL 340, 345, 350 / AS 3035, 3050 020794R1 APL 359	 358808M1	 036374R1	 061349R1 Lado Direito
 061350R1 Lado Esquerdo	 061237R1 Porta Planetário	 061237R1/P Pino Central	 061237R1/P Pino (Planetário)	 061242R1
 061274R1	 061273R1	 061294R1	 033725R1	 061296R1
 061297R1	 043132	 053958	 48307R1	 040942R1
 040953	 040954R1	 040968R1	 040957R1	 040949R1

*Imagens meramente ilustrativas.



MASSEY FERGUSON

 058456	 48287R1	 1481169	 1481516	 1676665
 1676666 LISO	 1676666	 1754643	 1754644	 1864869
 1866538	 3147527	 3147528	 32731127	 3409652
 894799	 897567	 FRESADA P FRESADA M FRESADA G	 1860890	 1484687
 033991	 1481635 487989 1481636 487990 1481873 489027 1481874 489030 2802521 489314 2802526 489315 3146770 489703 3146771 489705	 037461 1481397 037462 1481398 037463 1481392 037464 1481393 487207 2801790 487208 2801791		
 3145066 3145067 3149076 3149077 3317634 3317635	 1 1/2 X 13 1 1/2 X 505 1 1/2 X 280 1 1/2 X 530 1 1/2 X 295 1 1/4 X 13 1 1/2 X 320 1 1/4 X 14 1/2 1 1/2 X 390 1 1/4 X 280 1 1/2 X 450 1 1/4 X 342 1 1/2 X 460 1 1/4 X 370 1 1/2 X 468 1 1/4 X 370 1 1/2 X 471 1 1/4 X 500	 042735		
 1484073	 1488476	 1661065	 1684285	 180444

*Imagens meramente ilustrativas.

MASSEY FERGUSON

 180445	 180449	 191211	 2730372	 2800731
 2800906	 3098416	 3148787	 3175453	 3409164
 058424	 3409165	 874792	 898016	 898017
 898018	 898363			

*Imagens meramente ilustrativas.

TRAMONTINI

 47093340 APL 335, 340, 345, 350 / AS 3035, 3050	 47103122 APL 335 / AS 3035	 47103548 APL 340, 345, 350 / AS 3035, 3050	 47113014 APL 335, 340, 345, 350 / AS 3035, 3050	 47113073 APL 335, 340, 345, 350 / AS 3035, 3050
---	--	--	--	---

URSUS

 10047050	 10047156 APL 335 / AS 3035	 10047200 APL 340, 345, 350 / AS 3035, 3050	 10047206 APL 335, 340, 345, 350 / AS 3035, 3050	 10047212 APL 335, 340, 345, 350 / AS 3035, 3050
---	--	--	--	---



VALTRA / VALMET



CONJUNTO CARÇAÇA DE ARTICULAÇÃO

Carcaças	Pinos Pivô
80599920 LE	80607500
80599820 LD	80296100
81700300 LE	Porca Ranhurada
81700200 LD	80604000
	80907700

O Conjunto de Carcaça Montada acompanha:

QTD.	DESCRIÇÃO
01	Carcaça de Articulação
01	Porca Ranhurada
02	Pinos Pivô
06	Parafusos Sextavados

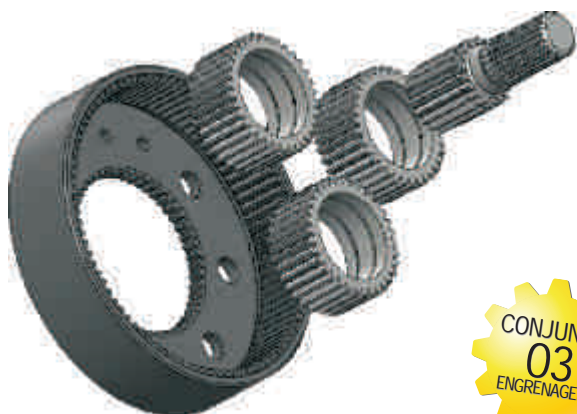

CONJUNTO DE ENGRENAGENS PORTADOR PLANETÁRIA

Engrenagem Dente Interno	Engrenagem
80608000 (Moderno)	80623100 (Moderno)
80908500	81817110
80297600 (Antigo)	80298200 (Antigo)

Eixo Solar

80623000 (Moderno) / 80908600 / 80297400 (Antigo)

O Conjunto de Engrenagens acompanha:

QTD.	DESCRIÇÃO
01	Engrenagem de Dente Interno
01	Eixo Solar
03	Engrenagens

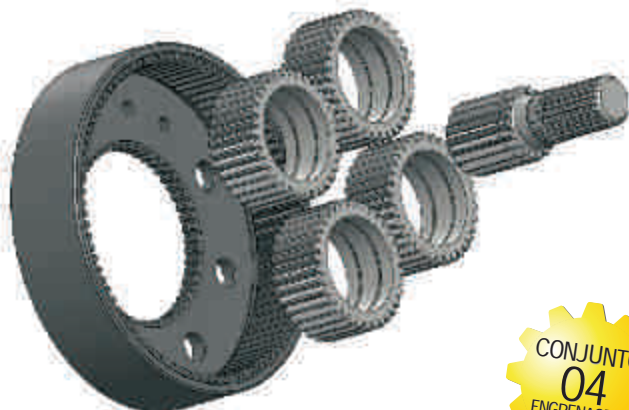

CONJUNTO DE ENGRENAGENS PORTADOR PLANETÁRIA

Engrenagem Dente Interno	Engrenagem
80608000 (Moderno)	80623100 (Moderno)
80908500	81817110
80297600 (Antigo)	80298200 (Antigo)

Eixo Solar

80623000 (Moderno) / 80908600 / 80297400 (Antigo)

O Conjunto de Engrenagens acompanha:

QTD.	DESCRIÇÃO
01	Engrenagem de Dente Interno
01	Eixo Solar
04	Engrenagens



* Imagens meramente ilustrativas.

VALTRA / VALMET

 80599920 LE APL 345, 350 / AS 3050 81700300 LE APL 359	 80599820 LD APL 345, 350 - AS 3050 81700200 LD APL 359	 80607400 • APL 350 / AS 3050 (04 Engrenagens / 04 Gear / 04 Engranajes)		
 80772900 (Moderno) APL 335, 340, 345 / AS 3035 80297300 (Antigo) APL 335 81703800 APL 359 (03 Engrenagens / 03 Gear / 03 Engranajes)	 80608000 (Moderno) APL 335, 340, 345, 350 / AS 3035, 3050 80908500 APL 359	 80297600 (Antigo) APL 335	 80623100 (Moderno) APL 335, 340, 345, 350 / AS 3035, 3050 81817110 APL 359	
 80623000 (Moderno) APL 345, 350 / AS 3050 80908600 APL 359	 80604000 APL 340, 345, 350 / AS 3035, 3050 80907700 APL 359	 80298200 (Antigo) APL 335	 80297400 (Antigo) APL 335	 80607500 APL 345, 350 / AS 3050 80296100 APL 335 / AS 3035
 81700500 APL 359	 80608400 APL 335	 81325900 APL 335	 80296100 (Antigo) APL 335	 81711200
 81241500 - Lado Direito	 81241600 - Lado Esquerdo	 81241800	 81235600	 81241900 Porta Planetário
 81241900/P Pino Central	 81241900/P Pino (Planetário)	 81293500	 81240000	 81263600
 81263700	 81880300 - Lado Esquerdo	 81880500 - Lado Direito	 34057300	 34051800

* Imagens meramente ilustrativas.



VALTRA / VALMET

 34051400	 81882400	 81882700	 34056800	 81884400
 34056900	 34057100	 34057900	 34058000	 82775600 - Lado Direito
 82775500 - Lado Esquerdo	 82775900	 82776400	 164410	 164490
 206091	656091	 222630	 222641	 222720
	206092 80331200			
	216610 80456810			
	217700 80881000			
 224230	 224241	 224262	 242410	 246530
 261100	 440520	 440530	 440590	 440600
 440680	 440790	 516390	 581430	 592240

*Imagens meramente ilustrativas.

VALTRA / VALMET

 614030	 615170	 641290	 641590	 651950
 820731	 822250	 823870	 825949	 845890
 30302210	 31337310	 34057100	 34057700	 45031120
 80086700	 80689710	 80717700 $\frac{3}{4}$ 80717700 $\frac{5}{8}$	 80905000	 81699900
 80985720	 81339910	 81339920	 81397410	 81674700
 81711300	 82444500	 83438700	 81861010 (Nylon)	 820950 LE
 821010 LD	 Haste - 213150	 Haste - 216690	 Haste Valmet Pequena Haste Valmet Média Haste Valmet Grande	

* Imagens meramente ilustrativas.



**CONJUNTO
CARÇAÇA DE ARTICULAÇÃO**

Carcaças

0095353245 LE
0095353244 LD
0095366093 LE
0095366095 LD

Pinos Pivô

4472353195
0095355011
4472352162

Porca Ranhurada

0737503042
0737503040

O Conjunto de Carcaça Montada acompanha:

QTD.	DESCRIÇÃO
01	Carcaça de Articulação
01	Porca Ranhurada
02	Pinos Pivô
06	Parafusos Sextavados

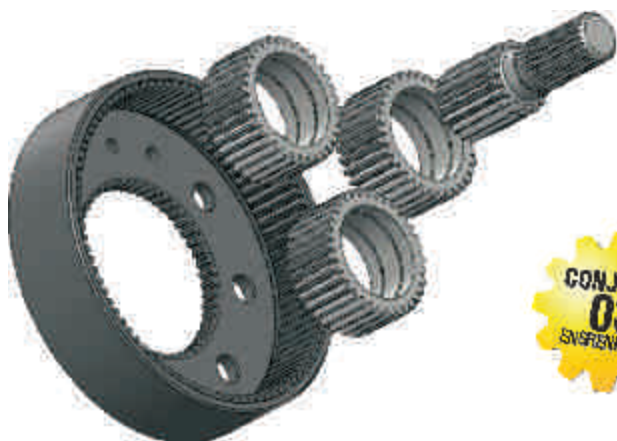

**CONJUNTO DE ENGRENAGENS
PORTADOR PLANETÁRIA**

Engrenagem Dente Interno

4472353419
4472352168
4472355143

Engrenagem

0095353232
4472352013
0095355031

Eixo Solar

4472353157 / 4472352074 / 0095355019

O Conjunto de Engrenagens acompanha:

QTD.	DESCRIÇÃO
01	Engrenagem de Dente Interno
01	Eixo Solar
03	Engrenagens

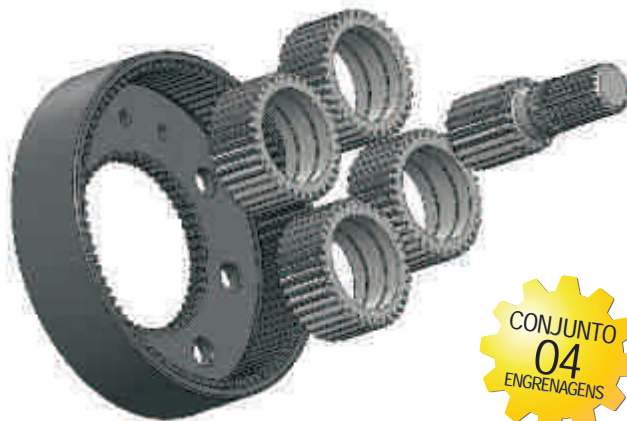

**CONJUNTO DE ENGRENAGENS
PORTADOR PLANETÁRIA**

Engrenagem Dente Interno

4472353419
4472352168
4472355143

Engrenagem

0095353232
4472352013
0095355031

Eixo Solar

4472353157 / 4472352074 / 0095355019

O Conjunto de Engrenagens acompanha:

QTD.	DESCRIÇÃO
01	Engrenagem de Dente Interno
01	Eixo Solar
04	Engrenagens

*Imagens meramente ilustrativas.

ZF



0095353245 LE
APL 340, 345, 350 / AS 3050

0095366093 LE
APL 359



0095353244 LD
APL 340, 345, 350 - AS 3050

0095366095 LD
APL 359



4472352103 (Antigo)
APL 335

4472353077 (Moderno)
APL 335, 340, 345 / AS 3035

0095366097
APL 359

(03 Engrenagens / 03 Gear / 03 Engranajes)



4472353183
APL 350 / AS 3050

(04 Engrenagens / 04 Gear / 04 Engranajes)



4472353419
APL 335, 340, 345, 350 / AS 3035, 3050

4472355143
APL 359



4472353157
APL 345, 350 / AS 3050

0095355019
APL 359



0095353232
APL 335, 340, 345, 350 / AS 3035, 3050

048348R1
APL 359



4472353195
APL 345, 350 / AS 3050
0095355011
APL 359



0737503042
APL 340, 345, 350 / AS 3035, 3050
0737503040
APL 359



4472352013
APL 335



4472352074
APL 335



4472352162 (Antigo)
APL 335



4472352168 (Antigo)
APL 335



4472353544
APL 335, 340, 345, 350 / AS 3035, 3050



0095353205
APL 335, 340, 345, 350 / AS 3035, 3050



0095353348
APL 335, 345, 350 / AS 3035, 3050



4472353516



0095308001
APL 359 / AS 3065



0095308006
APL 359 / AS 3065

*Imagens meramente ilustrativas.



LINHA INDUSTRIAL
INDUSTRIAL / INDUSTRIAL

ÍNDICE

CASE

28 a 33

KOMATSU

48 a 54

CATERPILLAR

34 a 37

MASSEY FERGUSON

55 a 57

EMPILHADEIRAS

CLARK / HYSTER / YALE

38

MICHIGAN

58

FIAT

39 a 45

SDLG

59

HUBER WARCO

45

VOLVO

59

HYUNDAI

45

JCB

46 a 47



Panegossi

CASE



8605835



87613439



87613444



100522A1



113629A1 D66699
399607A1 E62798
D28648 LONGO
E62798
E69422



100696A1	D129264	D151070	D33024	D43946	D65932	G103411
107124A1	D135557	D151073	D33047	D44543	D66640	G32050
109268A1	D135559	D151074	D34109	D44549	D66651	G34875
114318A1	D135741	D30756	D34340	D44648	D67150	G35396
135248A1	D137218	D30929	D37392	D46405	D69221	G35413
135249A1	D137345	D30930	D37443	D49429	D69222	G35418
192559A1	D138047	D30932	D37495	D50146	E60862	L17466
A12058	D140029	D30933	D37763	D50337	E60863	L42202
A75651	D145978	D31140	D38943	D51545	E63559	L70269
D127167	D149079	D31142	D40243	D52434	E65951	L70270
D127168	D149725	D31511	D42788	D52521	E66022	L72202
D127172	D149726	D31512	D43223	D55626	E66031	L72998
D127507	D150122	D32865	D43508	D60159	E97060	
D127542	D151069	D33023	D43940	D65731	E158752	



116339A1



118901A1 119129A1



118901A1 E62723



121665A1 E157930



121778A1



121779A1



124568A2



129040A1



129041A1



132890A1



135247A1



136296A1
D146288 E155088



138616A1



141005A1



142842A1



146329A1



146334A1



146336A1



146930A1



146930A1

*Imagens meramente ilustrativas.



CASE

 147058A1	 148236A1	 148346A1	 148657A1	 148658A1
 180427A1	 292385A1	 336388A1	 339521A1	 361128A1
 361133A2	 361139A2	 371885A2	 375326A2	 375328A1
 375330A1	 379091A2	 3800583A2	 399606A1	 A17122 L104286 L105211
 A17344	 A17345	 A17449	 A17560	 A17561
 A17611	 D37416	 A17611	 D37416	 D37416
 A28230	 A38930	 A63107	 A75239	 A76492
 D123865	 D132076	 D132494	 D135739	 D30931
	 D31219	 D45904	 D37450	 D67061
			 D141075	 D141076

*Imagens meramente ilustrativas.

CASE

 D141142	 D145767	 E62736	 D149033	 D149239	 D149298
 D150121	 D150155	 D150619	 D151034	 D151065	
 D151071	 D26002	 D37614	 D38261	 D38907	
 D49865	 D49866	 D49879	 D50698	 D56335	 E96620
 D67759	 D69588	 D71927	 L47952	 D72337	 D72371
 D95362	 E62796	 E62802	 E66074	 E62798	 E158734
 E159036	 E159037	 E159038	 E158925	 E159035	
	 E159043	 E159047			

*Imagens meramente ilustrativas.



 E159050	 E41415	 E60223	 E60864	 E60865		
 E60866	 E60871	 E62710	 E62735	 E62737	 E62805	
 E62795	 E62797	 E62800	 E64340	 E62803	 E62806	 E62804
 E62808	 E63980	 E63982	 E64038	 E64320	 E64343	
 E65357	 E65860	 E66294	 E69606	 E95653		
 E95946	 E96436	 E96632	 G100495	 G108512		
 G100986	 G34854	 J54287	 K924148	 L104342	 L104347	

*Imagens meramente ilustrativas.

CASE

 L105142 L105144		KT 580 L T	 L105214	 L109584
 L46480 L50464 L105212 L117143 L117466		KT 580 L D KT 580 L E KT 580 H T KT 580 H D KT 580 H E KT 580 H T SUPER KT 580 H D SUPER	 L109938	 L117068
 L125226	 L125227	 L125229	 L125271	 L125957 L127014
 L125972	 L125973	 L125974	 L128351	 L129129
 L15725	 L15800	 L15802 L47560 L73525 L73527	 L40421 L47562	 L47305
 L47306 L72204	 L47564	 L70331	 L70534	 L70757
 L72169	 L72199	 L72222	 L72226	 L73076

*Imagens meramente ilustrativas.



CASE

 L73170	 L73230	 L73569	 L73651	 L74482
 L77373	 P00028991M	 P00128738H	 P05428747	 P06884215S
		 P00128789N	 P05728766U	 T41342
<p>Case Traçado 4x4 Tractors Doble Tracción</p>	 100520A1	 100522A1	 100553A1	 100553A1/C
				 100553A1/P
 100561A1	 100562A1 - Dianteiro 580L	 116427A1	 122264A1	 122265A1
 144455A1 - Lado Esquerdo	 144456A1 - Lado Direito	 144466A1	 175977A1/P	 175979A1 - Traseiro 580L
 358286A1	 367184A1/P	 A12901	 A12905	 A18246/1
 A18258	 D50075	 D50081	 D50084	 E95677

*Imagens meramente ilustrativas.

CATERPILLAR

 0860523 CATERPILLAR 320L	 0875805 CATERPILLAR 320C/CL	 0875806 CATERPILLAR 320C/CL	 0875845 CATERPILLAR 320C/CL	 0990718 CATERPILLAR 320L
 0990721 CATERPILLAR 320L	 1003852 CATERPILLAR 938G	 1024560 CATERPILLAR 416D / 416E	 1189883 CATERPILLAR 320L	 1195200 CATERPILLAR 320L
 1195214 CATERPILLAR 320L	 1195228 CATERPILLAR 930	 1195229 CATERPILLAR 320L	 1289863 CATERPILLAR 320L	 1289882 CATERPILLAR 930
 1297770 CATERPILLAR 320L	 1301638 CATERPILLAR 416C / 416D / 416E	 1305451 CATERPILLAR 416C / 416D / 416E	 3K6616	
 8E5035 315C/CL • 320C/CL	 1326496 CATERPILLAR 416C / 416D / 416E	 1372919 315C/CL • 320C/CL	5M4448	7M5109
 1633749 315C/CL • 320C/CL	 1680443 CATERPILLAR 416C / 416D / 416E	 1680444 CATERPILLAR 416C / 416D / 416E	7G0419	5M1247
 3G4704 CATERPILLAR 938G	 7K7200	 Ponta de Eixo - 2D4215 LD Ponta de Eixo - 2D4216 LE CATERPILLAR 120B	1318742	INF CLAYSON M
 1935015 320C/CL	 2276789 315C/CL	 414809 CATERPILLAR 320L / 320C/CL	5M1915 ANTIGO	5M1915 MODERNO

*Imagens meramente ilustrativas.



CATERPILLAR

 4I4813 CATERPILLAR 320L / 320C/CL	 4I4814 CATERPILLAR 320L	 4K8225 CATERPILLAR 966	 4K9984 5K0305 5M5005 6T3282 9K8856
 4V0380 CATERPILLAR 966	 4V3625 CATERPILLAR 938G	 5K8265 CATERPILLAR 966	 6J2242 CATERPILLAR 930
 6K6045 CATERPILLAR 930	 6K6046 CATERPILLAR 930	 6K6051 CATERPILLAR 930	 6K6053 6K6054 CATERPILLAR 930
 6K6175 CATERPILLAR 930	 7K9344 CATERPILLAR 930	 6K6185 CATERPILLAR 930	 6K8307 6K8308 6K8310 7K9513 CATERPILLAR 966
 6K9861 9S3565 3T3207	 7I6843 CATERPILLAR 320L	 7J9682 CATERPILLAR 930	 7J9699 CATERPILLAR 930
 7J9842 CATERPILLAR 930	 7K0088 CATERPILLAR 930	 7K7176 CATERPILLAR 930	 7K9343 CATERPILLAR 930
 7K9345 CATERPILLAR 930	 7K9514 7K9515 CATERPILLAR 966	 7K9589 CATERPILLAR 930	 7K9601 CATERPILLAR 930
 7K9602 CATERPILLAR 930	 7K9603 CATERPILLAR 930	 7K9604 CATERPILLAR 930	 7K9638 CATERPILLAR 966
 7K9639 CATERPILLAR 966	 7K9604 CATERPILLAR 930	 7K9638 CATERPILLAR 966	 7K9639 CATERPILLAR 966

*Imagens meramente ilustrativas.

CATERPILLAR

 7K9640 CATERPILLAR 966	 7K9642 CATERPILLAR 966	 7K9643 CATERPILLAR 966	 7K9644 CATERPILLAR 966	 7Y2348 CATERPILLAR 320L	 7Y2357 CATERPILLAR 320L / 320C/CL
 7Y2395 CATERPILLAR 320L	 7Y3428 CATERPILLAR 930	 7Y5128 CATERPILLAR 930	 8E5601 CATERPILLAR 315C/CL • 320C/CL	 8V7659 CATERPILLAR 938G	
 9R0111 CATERPILLAR 416C / 416D / 416E	 9R0139 CATERPILLAR 416D / 416E	 9R0147 CATERPILLAR 416D / 416E	 9R0153 CATERPILLAR 416C	 9R0320 CATERPILLAR 416C / 416D / 416E	
 9R0321 CATERPILLAR 416D / 416E	 9R0411 CATERPILLAR 416C / 416D / 416E	 9R0413 CATERPILLAR 416D / 416E	 9R0422 CATERPILLAR 416C / 416D / 416E	 9R0423 CATERPILLAR 416C / 416D / 416E	
 9R0424 CATERPILLAR 416C / 416D / 416E	 9R0431 CATERPILLAR 416D / 416E	 9R0437 CATERPILLAR 416D / 416E	 9R1104 CATERPILLAR 416C / 416D / 416E	 9R1107 CATERPILLAR 416C / 416D / 416E	
 9R3092 CATERPILLAR 416D / 416E	 9R3182 CATERPILLAR 416C / 416D / 416E	 9R3933 CATERPILLAR 416C	 9R4110 CATERPILLAR 416D / 416E	 9R4494 CATERPILLAR 416C / 416D / 416E	
 9R4676 CATERPILLAR 416C	 9R4677 CATERPILLAR 416C	 9R5828 CATERPILLAR 416C / 416D / 416E	 9R6690 CATERPILLAR 416C	 9R7891 CATERPILLAR 416C	

*Imagens meramente ilustrativas.



CATERPILLAR



GR D4C	GR D8H
GR D4C PFM	GR D814A
GR D4D	GR D9G
GR D4D PFM	GR 312L
GR D4E	GR 312L 4140
GR D4E PFM	GR 320L
GR D5	GR 320L 4140
GR D5 4140	GR 931
GR D6A	GR 941
GR D6C	GR 955H
GR D6M	GR 955K
GR D6R	GR 955L
GR D7A	GR 977L
GR D7E	



GR D4E COLH

GR D6C CR

*Imagens meramente ilustrativas.

EMPILHADEIRAS

CLARK

EMPILHADEIRAS - Fork Lifters / Montacargas

 103890	 107234	 108796	 110520	 112500
 128513	 323261	 2347167	 2360874	 3312664
 3314434	 3323260			

HYSTER

EMPILHADEIRAS - Fork Lifters / Montacargas

 129259	 162598	 185330	 185531	 300765
 300766	 323260	 193557	 196445	 800765
 300766	 300982	 326498	 804693	 807526

*Imagens meramente ilustrativas.

YALE

EMPILHADEIRAS - Fork Lifters / Montacargas

 163448	 5088018	 666168	 666169	 666170
---	--	---	---	---



592509	4971690	76022681	8271634 76021470 76021870	8280391 FIAT FR10B • FR12B	8280936
8284858	8285377	9967992 FIAT LB90	9968010 FIAT LB90	45006013	
45007752	76022114	45007757	45007764	71400206 FIAT FH200	71400222 FIAT FH200
71415092 FIAT FH200	71415176 FIAT FH200	71415177 FIAT FH200	71415178 FIAT FH200	71415182 FIAT FH200	
71415183 FIAT FH200	71415408 FIAT FH200	71418421 FIAT FX215	71418493 71418583 FIAT FX215		75213214
71420064 FIAT FH200	71420065 FIAT FH200	73124680	73125531	73126245 75261188	
73133514	73160978	73160981	73180081 FIAT FX215	73180105 FIAT FX215	

*Imagens meramente ilustrativas.

FIAT

 73180106 FIAT FX215	 73180125 FIAT FX215	 73180126 FIAT FX215	 75213115 75213179 75237948 76021677	76021680 76022051 76022055 76022096
 75213209	 76021555	 75216487	75213218 75235420 75260976 76021403	76021525 76021540 76022112 76022697 76022698  75213252
 75213254	 75213255	 75213256	 75213386	 75213600
 75213765	 75213902	 75213903	 75216516	 75216645 FIAT FR10B • FR12B • FW140
 75216651	 75216668 FIAT FR10B • FR12B FIAT FW140 • FW160	 75216669 FIAT FR10B • FR12B	 75216674 FIAT FR10B • FR12B FIAT FW140 • FW160	 75216676 FIAT FR10B • FR12B FIAT FW140 • FW160
 75218127 FIAT FR10B • FR12B FIAT FW140	 75218505 FIAT FR12B	 75218611 FIAT FR10B / FR12B	 75218614 FIAT FR10B • FR12B	 75218622
 75218644 FIAT FR12B	 75219071 FIAT FR10B • FR12B	 75219869 FIAT FR10B • FR12B	 75222313 FIAT FR12B	 75222645 FIAT FR12B

*Imagens meramente ilustrativas.



 75222646 FIAT FR12B	 75235386	 75235393	 75235395	 75235421 FIAT FW140 • FW160
 75235424	 75235488	 75235498	 75237949 FIAT FB80 / FB100	 75238951
 75239508 FIAT FW140	 75239509 FIAT FW140	 75243854 FIAT FH200	 75243855 FIAT FH200	 75244608 FIAT FB80 / FB100
			 75244564 FIAT FW140 • FW160	
 75245259 FIAT FW140	 75245277 FIAT FW140	 75245294 FIAT FW140	 75245372 FIAT FB80 / FB100	 75245373 FIAT FB80 / FB100
 75245378 FIAT FB80 / FB100	 75245455	 75245999 FIAT FB80 / FB100	 75246111 FIAT FH200	 75247594 FIAT LB90
 75247595	 75248202 FIAT FB80 / FB100	 75249552 FIAT FW140	 75254211 FIAT FX215	 75254214 FIAT FX215
 75254217 FIAT FX215	 75254221 FIAT FX215	 75254408 FIAT FX215	 75255753 FIAT FB80 / FB100	 75255825 FIAT FX215

*Imagens meramente ilustrativas.

FIAT

 75261185	 75261187	 76001768	 76021404	 76021436 FIAT FB80 / FB100
 76021437 FIAT FB80 / FB100	 76021461	 76021462	 76021463	 76021466 FIAT LB90 • FB80 • FB100
 76021496	 76021473	 76021546 FIAT FB80 / FB100	 76021553	 76021584 FIAT FB80 / FB100
 76021727	 76021650	 76021753 FIAT FB80 / FB100	 76021869	 76021883 FIAT FB80 / FB100
 76021937 FIAT FB80 / FB100	 76021939	 76022298	 76022303	 76022325 76022329
 76022372	 76022614	 76022621	 76022682	 76022683
 76022684	 76022685	 76022740	 76022741 FIAT FB80 / FB100	 76022742

*Imagens meramente ilustrativas.



 79088197 FIAT FW140	 79106029 FIAT FW140 • FW160	 79106030	 79106037 FIAT FW140 • FW160	 81901809 FIAT LB90
 81901896 FIAT LB90 • FB80 • FB100	 81901897 FIAT LB90 • FB80 • FB100	 81902174 FIAT LB90 • FB80 • FB100	 83902710 FIAT LB90 • FB80 • FB100	 83910546 FIAT LB90 • FB80 • FB100
 83910547 FIAT LB90 • FB80 • FB100	 83910548 FIAT LB90 • FB80 • FB100	 83910551 FIAT LB90 • FB80 • FB100	 83910557 FIAT LB90 • FB80 • FB100	 83910558 FIAT LB90
 83910634 FIAT LB90 • FB80 • FB100	 83910645 FIAT LB90 • FB80 • FB100	 83911000 FIAT LB90 • FB80 • FB100	 83912378 FIAT LB90 • FB80 • FB100	 83959693
 83959695	 83999466 FIAT LB90 • FB80 • FB100	 85700728 FIAT LB90 • FB80 • FB100	 85800202 FIAT LB90 • FB80 • FB100	 85800303 FIAT LB90 • FB80 • FB100
 85801026 FIAT LB90 • FB80 • FB100	 85801029 FIAT LB90 • FB80 • FB100	 85801049 FIAT LB90	 85801050 FIAT LB90 • FB80 • FB100	 85801056 FIAT LB90 • FB80 • FB100
 85801076 FIAT LB90 • FB80 • FB100	 85801079 FIAT LB90 • FB80 • FB100	 85801086 FIAT LB90 • FB80 • FB100	 85801087 FIAT LB90 • FB80 • FB100	 85801097

*Imagens meramente ilustrativas.

FIAT

 85801110 FIAT LB90 • FB80 • FB100	 85801262 FIAT LB90 • FB80 • FB100	 85801308 FIAT LB90	 85801314	 85802870
 85802871	 85802872 FIAT LB90 • FB80 • FB100	 85802975 FIAT LB90 • FB80 • FB100	 85802993 FIAT LB90 • FB80 • FB100	 85802994
 85803002 FIAT LB90 • FB80 • FB100	 85803005 FIAT LB90 • FB80 • FB100	 85803139 FIAT LB90 • FB80 • FB100	 85803140	 85803141 FIAT LB90 • FB80 • FB100
 85803192 FIAT LB90 • FB80 • FB100	 85803193 FIAT LB90 • FB80 • FB100	 85803194 FIAT LB90 • FB80/4 • FB100/4	 85803196 FIAT LB90 • FB80/4 • FB100/4	 85803197 FIAT LB90 • FB80/4 • FB100/4
 85815607 FIAT LB90 • FB80/4 • FB100/4	 85815517 FIAT LB90 • FB80/4 • FB100/4	 85813469 FIAT LB90 • FB80/4 • FB100/4	 85803246 FIAT LB90 • FB80/4 • FB100/4	 85815698 FIAT LB90 • FB80/4 • FB100/4
 71415163C FIAT FH200	 71415163L FIAT FH200	 4982687	 4972921	 75201430
 4964254	 75244685	 76001769	 592564	 4963951
			 4979789	 75244684

*Imagens meramente ilustrativas.



FIAT



GR AD7
GR AD7 PFM
GR AD7 53
GR AD7 53 PFM
GR AD14
GR AD14 CS
GR E215
GR FH200
GR FH220
GR FH240
GR FX215
GR FX215 4140



GR AD7 CR
GR FD9

GR AD14 CS CR
GR FD130
GR FD170



9967992
FIAT LB90



9967993
FIAT LB90



9968007
FIAT LB90



9968010
FIAT LB90

HUBER WARCO



6300028



6300029

HYUNDAI



E210

















*Imagens meramente ilustrativas.

JCB

 10192019 Aplicação: JCB 3C	 12030002 Aplicação: JCB 3C	 12030002 ZINCO Aplicação: JCB 3C	 12581000 Aplicação: JCB 3C	 23201100 Aplicação: JCB 214E
 23203906 Aplicação: JCB 214E	 23203907 Aplicação: JCB 214E	 40300750 Aplicação: JCB 3C	 80800176 Aplicação: JCB 3C	 80800296 Aplicação: JCB 3C
 80800385 Aplicação: JCB 3C	 80800388 Aplicação: JCB 3C	 80900102 Aplicação: JCB 3C	 80900105 Aplicação: JCB 214E	 80900106 Aplicação: JCB 214E
 80900107 Aplicação: JCB 214E	 80900108 Aplicação: JCB 214E	 80900109 Aplicação: JCB 214E	 80900110 Aplicação: JCB 214E	 80900131 Aplicação: JCB 3C
 80900177 Aplicação: JCB 3C	 80920059 Aplicação: JCB 214E	 81120058 Aplicação: JCB 214E	 81120061 Aplicação: JCB 3C	 81150335 Aplicação: JCB 214E
 81150336 Aplicação: JCB 214E	 81150338 Aplicação: JCB 214E	 81150341 Aplicação: JCB 214E	 81150344 Aplicação: JCB 214E	 81150350 Aplicação: JCB 214E
 81150369 Aplicação: JCB 3C	 81150372 Aplicação: JCB 3C	 81150376 Aplicação: JCB 214E	 81150381 Aplicação: JCB 3C	 81150390 Aplicação: JCB 214E

*Imagens meramente ilustrativas.



 81150436 Aplicação: JCB 3C	 81150489 Aplicação: JCB 214E	 81150520 Aplicação: JCB 3C	 81170098 Aplicação: JCB 3C	 81180004 Aplicação: JCB 3C
 81190198 Aplicação: JCB 3C	 81190382 Aplicação: JCB JS200	 81190483 Aplicação: JCB 3C	 81190593 Aplicação: JCB 3C	 82900548 Aplicação: JCB 3C
 83110211 Aplicação: JCB 3C	 83110229 Aplicação: JCB 3C	 83110232 Aplicação: JCB 214E	 83110233 Aplicação: JCB 214E	 83110291 Aplicação: JCB JS200
 91112400 Aplicação: JCB 3C	 91140106 Aplicação: JCB 3C	 91310079 Aplicação: JCB 3C	 JRV0071 Aplicação: JCB JS200	 JRV0593 Aplicação: JCB JS200
 JRV0594 Aplicação: JCB JS200	 JRV0595 Aplicação: JCB JS200	 JRV0597 Aplicação: JCB JS200	 KRV1121 Aplicação: JCB JS200	 KRV1122 Aplicação: JCB JS200
 KRV1124 Aplicação: JCB JS200	 KRV1126 Aplicação: JCB JS200	 KRV1127 Aplicação: JCB JS200	 KRV1572 Aplicação: JCB JS200	 KSV0457 Aplicação: JCB JS200

*Imagens meramente ilustrativas.

KOMATSU

				
092414B180	092415A140	092415A230	1127011190	1207021210
				
1207039160	1207039170	1242252240	1242751241	1243051180
	1243051141			
1413016111	1413036130	1243051142	1243053120	1243251190
		1243051143		
	1243051181			
1413033122		1247251660	1247251770	1267051450
				
12F7241391	12F7241470	12H7211380	12H7211580	1302212141
				
1303013129	1304351271	1306312660	1307012111	1307012131
				
1307012190	1307041120	1307045170	1307053250	1307831140

*Imagens meramente ilustrativas.

 1307831150	 13001B1451	 13001B1452	 13001B1550	 13010B1291
 13010B1360	 13010B2720	 13010B3380	 13014B1560	 13014B1580
 13014B1650	 13030B1180	 13030B2350	 13032B1130	 13032B1140
 13032B5160	 13032B5180	 13050B1110	 13070B1120	 13070B1410
 13F5031131	 1311041450	 1311442630	 1317831221	 1317831250
 1317831270	 1343062220	 1343062241	 1345061140	 1345061150
 1345061171	 1345062121	 1345062131	 1347261331	 1347261540

*Imagens meramente ilustrativas.

KOMATSU

				
1347271850	1352712250	1353015110 1413035120	1407013130	1408037190
				
1412712640	1413031350	1441311750	1441522510	1441522521
				
1441522530	1445011120	1446015431	1447011160	1447012130
				
1447012181	14478B5210	1448541280	1448542870	14U7012120
				
14X7811310	1451542520	1451542530	1453031250	1501011170
				
1547122470	1701011460	2027061180	2027064161	2033042220
				
2033052141	2034656260 KOMATSU PC150/5	2037042182	2037044380	2037056130

*Imagens meramente ilustrativas.



2037056140



2037056150



2037056160



2057065680
KOMATSU PC200/6



2057065762
KOMATSU PC200/6



2057066550



2057067150
KOMATSU PC200/6



2057071190
KOMATSU
PC200/6 • PC200/8 • PC200 LC/8



2057071210



2057071360



2057072130
KOMATSU PC200/6



2057072180
KOMATSU
PC200/6 • PC200/8 • PC200 LC/8



2057073160
KOMATSU PC200/6



2057073180
KOMATSU
PC200/6 • PC200/8 • PC200 LC/8



2057073270
KOMATSU
PC200/6 • PC200/8 • PC200 LC/8



2057074381
KOMATSU PC200/6



2057074391
KOMATSU PC200/6



2067051190
KOMATSU PC200/6



2067053150



2067055160



2067055280



2077032140



2077034240



2077061230



2077072470



20Y2622250



20Y3013130



20Y3016170



20Y3211190



20Y7011180
KOMATSU PC200/6



20Y7032351



20Y7032361



21K01B1620



21K01B1621



21K7011170

*Imagens meramente ilustrativas.

KOMATSU

 21K7012151 KOMATSU PC150/5	 21K7012161 KOMATSU PC200/8 • PC200 LC/8	 21K7012170 KOMATSU PC200/6	 21K7013150 KOMATSU PC150/5	 21K7022120 KOMATSU PC150/5
 21K7021180	 21K7021170 KOMATSU PC150/5	 21K7022130 KOMATSU PC150/5	 21K7023140 KOMATSU PC150/5	 21K7023150 KOMATSU PC150/5
 21K7023170 KOMATSU PC150/5	 21K7023190 KOMATSU PC150/5	 21K7023220 KOMATSU PC150/5	 21K7031170 KOMATSU PC150/5	 21K7031310 KOMATSU PC150/5
 21K7031360 KOMATSU PC150/5	 21K7031390 KOMATSU PC150/5	 21K7032120 KOMATSU PC150/5	 21K7071160	 21K7071170
 21K7071180	 21K7072211	 21K7072230	 21K7072240	 21K7072250
 21K7074210	 21K7074220	 21P60K2730	 21P60K2850	 21P60K2860
 22U3011420	 22U7021191 KOMATSU PC200/8 • PC200 LC/8	 417011890	 4172211410	 4174611240

*Imagens meramente ilustrativas.



4177011590
KOMATSU WA180



4177011860
KOMATSU WA180



4182211412



4182212510



4184611141



4184611160
KOMATSU WA180



4187011860
KOMATSU WA180



4187011910
KOMATSU WA180



4187011921
KOMATSU WA180



4187011941
KOMATSU WA180



4187011950
KOMATSU WA180



4187011961
KOMATSU WA180



4187011972
KOMATSU WA180



4194611170



4194611180



4194612240
KOMATSU WA180



4194612260
KOMATSU WA180



4197011790



4197011810



4197011820
KOMATSU WA320/5



4197011890
KOMATSU WA320/5



4197011911



4197011922



4197011941



4197011981



4197021810
KOMATSU WA320/5



4197031220
KOMATSU WA320/5



4197031810
KOMATSU WA320/5



4197031870
KOMATSU WA320/5



4197031920
KOMATSU WA320/5



4197031960
KOMATSU WA320/5



4247011870



6631214311



7077610140



7077640020
KOMATSU WA180

*Imagens meramente ilustrativas.

KOMATSU



7077665220



7077670080



7077670160



7077670230
KOMATSU PC150/5



7077670330
KOMATSU PC150/5



7077670370
KOMATSU PC150/5



7077675030



7077680010



7077680020



7077680230
KOMATSU PC150/5



7077680470



714310707



714410404



714410506



- | | |
|----------------|------------|
| GR D30 45 | GR D50 P |
| GR D30 47 | GR D60 |
| GR D41A 54 | GR D61 |
| GR D41A 54 | GR D65 |
| GR D41E 56 | GR PC150/3 |
| GR D50 CV | GR PC150/5 |
| GR D50 CV 4140 | GR PC200 |
| GR D50 SV | GR PC220 |



GR D41E 59 CR
GR D50 CR

GR D155 FINA
GR D155 GROSSA

Embreagem Komatsu D50

Clutch Komatsu D50
Embrague Komatsu D50



13010B2130



13010B2170



13010B2220



13010B2240



13010B2860



13010B3190



13010B3380



1411013170

*Imagens meramente ilustrativas.



MASSEY FERGUSON

 024000	 024192	 024204	 034229	 024206	 024209	 034230
 024210	 024419	 024425	 024429	 028925		
 033991	 036452	 036582	 042651	 037919		
 040208	 041614	 042765	 043698	 043716		
 364231	 516390	 729210	 824996	 862589		
 862617	 862620	 862627	 862661	 862663		
 862665	 862672	 862691	 862967	 863064		

*Imagens meramente ilustrativas.

MASSEY FERGUSON

 863147	 871315	 871318	 2750610	 871352	 871417
 871454	 871455	 871456	 871458	 871459	
 871460	 871462	 871466	 871468	 871705	 3411872
 871710	 871729	 871792	 874620	 898363	
 981443	 981444	 1458757	 2710881	 2710891	 2710883
 2750504	 2750597	 2752109	 2757609	 2757721	
 2757734	 2757953	 2803248	 3147278	 3147301	

*Imagens meramente ilustrativas.



MASSEY FERGUSON

 3147313	 3149143	 3175777	 3175831	 3408490
 3408498	 3409001	 3409139	 3409425	 3409652
 3411146	 3411479	 3411480	 3411856	 3411868
 3411873	 3500009	 3500034	 3500035	 3500036
 3500037	 3500046	 3500047	 3501015	 3501769
 3501770	 3511550	 3587841	 3587846	 3587902
 3588880	 881156SH			KT MF750 T FASE 2 KT MF750 D FASE 2 KT MF86 T KT MF86 DIRECAO KT MF86 DIANTEIRO KT MF96 T FASE 2

*Imagens meramente ilustrativas.

MICHIGAN

 513372	 514921	 536100	 542631	 538585	 542031
 564129	 568482	 568483 A	 568483 M	 571022 1530602	
 585007	 587900	 587901	 587908	 589023	 1502644
 1508238	 1508556	 1508569	 1508570	 1508731	
 1509147	 1511516	 1521218	 1521241	 1522035	
 1529902	 1540234	 1543086	 1543088	 2540853	
 2540854	 2555864	 2555865	 2555867	 3300403	 5098061
	 12705621				

*Imagens meramente ilustrativas.



SDLG

 2110900260 SDLG - LG936	 3110900011 SDLG - LG936	 4043000112 SDLG - LG936	 4043000119 SDLG - LG936	 4043000120 SDLG - LG936
 4043000121 SDLG - LG936	 4043000123 SDLG - LG936	 4043000124 SDLG - LG936	 4043000202 SDLG - LG936	 4043000204 SDLG - LG936
 4043000205 SDLG - LG936	 4043000218 SDLG - LG936			

VOLVO

	GR EC210
	GR EC240

*Imagens meramente ilustrativas.



LINHA CANAVIEIRA
SUGAR CANE LINE / CAÑERA

ÍNDICE

CASE

64 a 67

JOHN DEERE

68 a 70



Panegossi

CASE

 00141650	 00141686	 146930A1	 377353A1	 399606A1
 401379A1	 401380A1	 403262A1	 403336A1	 403337A1
 432700A1	 443351A1	 443663A1	 446837A1	 450666A1
 450670A1	 81234900 P4	 82085300	 83001500	 83048300
	 81234900			
 86304126	 86308774	 86308778	 86308780	 86308782
 86309567	 86356400	 86372200	 86372400	 86372200 P4
 86372400 P4	 86372400 P4M (Montada - com chapa embutida)	 86376400 P4	 86376500 P4	
		 86376400	 86376500	

*Imagens meramente ilustrativas.



CASE

 86376600	 86376700 P4	 86376800 P4	 86624900	 8698700
	 86376700	 86376800		
 86700800	 86700800 REFORÇADO	 86701200	 86701200 REFORÇADO	 86701900
 86787100	 86787200	 86788000	 86901200 P4	 86965900
 86972200	 86973300	 86973401	 86984761	 86989400
 87150500	 87191100 (41 Dentes)	 87191200 (52 Dentes)	 87213269	 87213555
				 87215160
 87215720	 87215721	 87215722	 87215723	 87217726
 87220013	 87220065	 87220204	 87220207	 87220215

*Imagens meramente ilustrativas.

CASE

				
87220216A	87220216M	87220217	87220477	87220479
				
87223440	87223442	87223444	87223565	87224841
				
87227853	87230587	87230605	87232114	87232771
				
87232772	87232772M	87232884	87233602	87237086
				
87237359	87237362	87238848	87238849	87239604
				
87239608	87239615	87239618	87239657	87239943
				
87240136	87240137	87242109	87242110	87242111

*Imagens meramente ilustrativas.



CASE

 87244618	 87244744	 87246767	 87248159
 87248792	 87252422	 87254514	 87254786
 87254870	 87254887	 87255126	 87255400
 87256248	 87408127	 87408129	 87408130
 87410456	 87412514	 87413655	 87422205
 87436253	 87437015	 87438700	 87443401
 FC208	 FC210		

*Imagens meramente ilustrativas.

JOHN DEERE

 0071324735	 0110005999	 0110292066	 0130009533	 0130300006
 0131332512	 0151351877	 0221329657	 0221329659	 0221349755
 0261305008 (Bronze)	 0261340058	 0290205933	 0290205948	 0290205973
 0290205978	 0290206625	 0290207303	 0290208096	 0290209254
 0290230961	 0290238094	 0290240805	 0290241936	 0290241974
 0290244617	 0290247184	 0290247347	 0290248282	 0290250715
 0290254473	 0290255377	 0290262482	 0290278198	 0290279151

*Imagens meramente ilustrativas.



 0290279967	 0290294195	 0291353000	 0291376068	
 0300048144	 0300048144 - Reforçado	 0300048145	 0300048145 - Reforçada	 1190206215
 1190216370	 1190285632	 1190285633	 1190291388	 1190299865
 1190330569	 1190331192	 1190331193	 1191364728	 CB01392503
 CB01418406	 CB01418408	 CB01418422	 CB01418495	 CB01419834
 CB01421378	 CB01424053	 CB01425268	 CB01425904	 CB01425931
 CB01429372	 CB01432023	 CB01432051	 CB01432227	

*Imagens meramente ilustrativas.

JOHN DEERE

 CB01432669	 CB01434528	 CB01435017	 CB01437166	 CB01437885
 CB01437885 (Moderna)	 CB01438063	 CB01439472	 CB01440730	 CB01441436
 CB01452788	 CB01453477		 CB01455724	 CB01455929
 CB01464323	 CB01464324	 CB01464592	 CB01464665	 CB01465024
 CB01469302	 CB01471077	 CB01472867	 CB01474508	
 CB01475268	 CB11420776	 CB11426565	 FC208	 FC210
 NW00241	 NW00242	 NW10003		

*Imagens meramente ilustrativas.

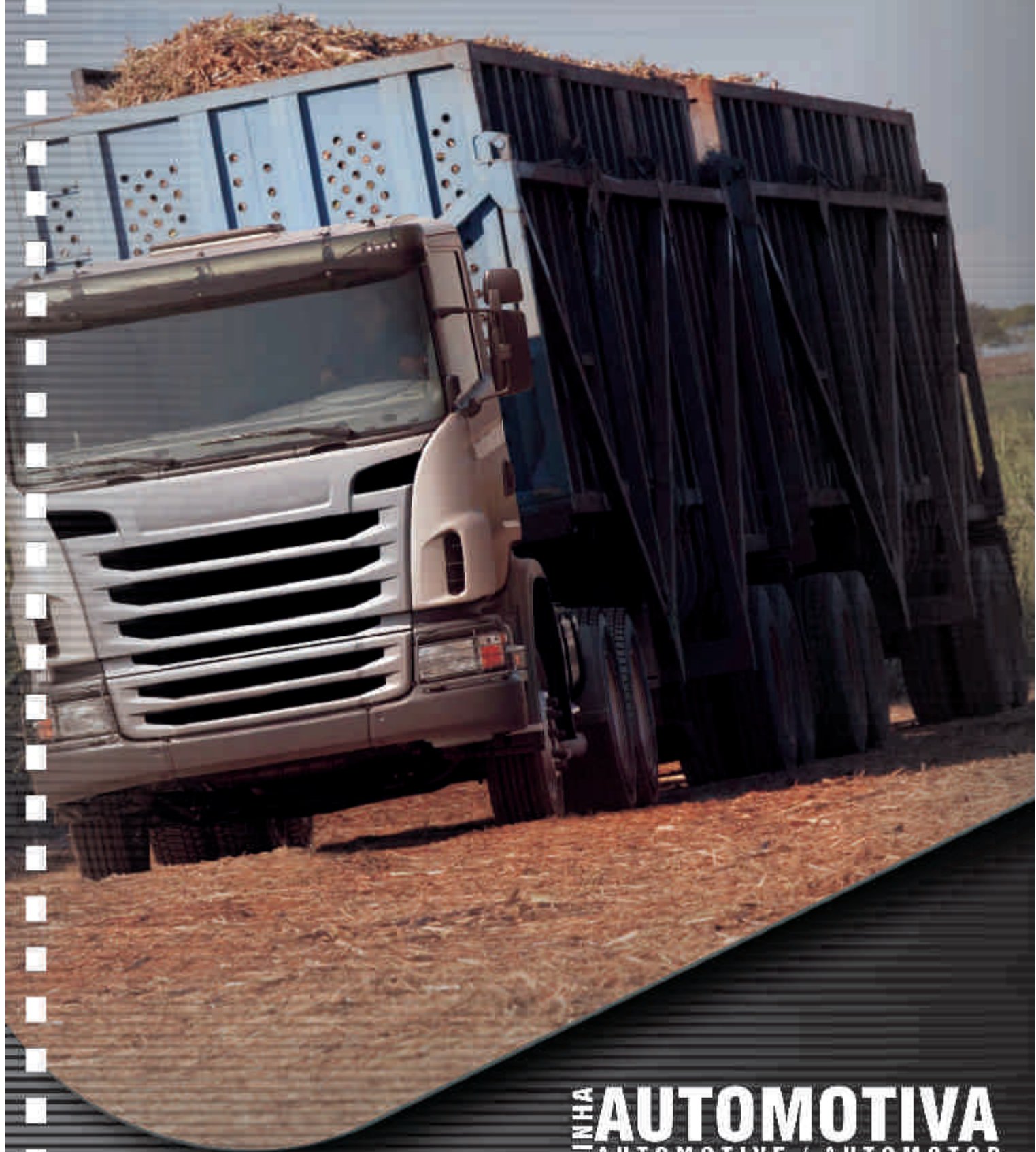

LINHA **AUTOMOTIVA**
LAUTOMOTIVE / AUTOMOTOR

ÍNDICE

ENGATE

72



Panegossi

ENGATE

Coupling - Enganche



B. CORPO ENGATE FNV



B. OLHAL FNV C/ ABA



B. DO OLHAL FNV 50MM



B. PONTA PINO FNV



P. ENGATE FNV 50MM



PORCA FNV 50MM

*Imagens meramente ilustrativas.



55 (16) 3383-2000

E-mail: comercial@panegossi.ind.br

www.panegossi.ind.br

Rua Ítalo Ferreira, 386 • Centro • Cep 15990-670 • Matão • SP • Brasil

